

USER MANUAL

DCS-2103

VERSION 1.0



Table of Contents

Product Overview	4	Application	30
Package Contents	4	Add Server	31
System Requirements	4	Add Media	32
Hardware Overview	5	Add Event	34
Front	5	Add Recording	36
Rear	6	SD Card	38
Side	7	Advanced	39
Installation	8	Digital Input/Output	39
Starting the Camera Installation Wizard	8	HTTPS	40
Configuration	9	Access List	41
Using the Configuration Menu	9	Maintenance	42
Live Video	10	Device Management	42
Setup	12	Backup and Restore	43
Wizard	12	Firmware Upgrade	44
Internet Connection Setup Wizard	12	Status	45
Motion Detection Setup Wizard	15	Device Info	45
Network Setup	17	Logs	46
Dynamic DNS	20	Help	47
Image Setup	21	Appendix	48
Audio and Video	23	DI/DO Input Specifications	48
Preset	25	Technical Specifications	49
Motion Detection	27		
Time and Date	28		
Event Setup	29		

Preface

D-Link reserves the right to revise this publication and to make changes in the contents hereof without obligation to notify any person or organization of such revisions or changes.

Manual Revisions

Revision	Date	Description
1.0	June 20, 2011	DCS-2103 Revision A1 with firmware version 1.00

Trademarks

D-Link and the D-Link logo are trademarks or registered trademarks of D-Link Corporation or its subsidiaries in the United States or other countries. All other company or product names mentioned herein are trademarks or registered trademarks of their respective companies.

Copyright © 2011 D-Link Corporation.

All rights reserved. This publication may not be reproduced, in whole or in part, without prior expressed written permission from D-Link Systems, Inc.

Package Contents

- DCS-2103 Network Camera
- CAT5 Ethernet cable
- Power adapter
- Camera stand
- CD-ROM with User Manual and software
- Quick Installation Guide

If any of the above items are missing, please contact your reseller.



System Requirements

- Existing 10/100 Ethernet-based network
- Computer with Windows 7/Vista/XP for Camera Setup Wizard
- Internet Explorer, Firefox, Opera, or other web browser for web interface (Internet Explorer recommended for full functionality)

If any of the above items are missing, please contact your reseller.

Hardware Overview

Front



Rear

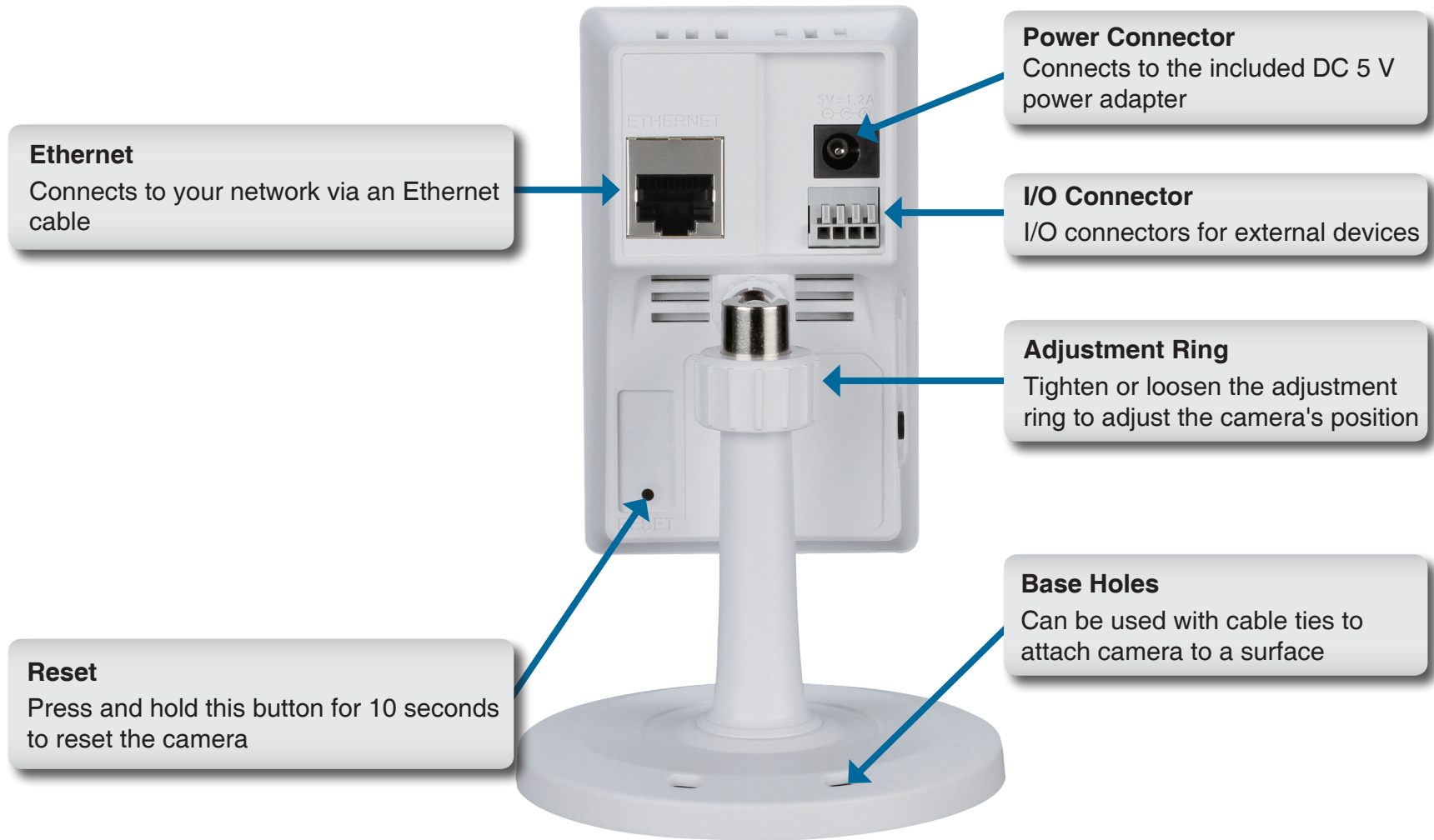

Side



Starting the Camera Installation Wizard

Insert the Installation CD-ROM into your computer's optical drive to start the autorun program.

The CD-ROM will open the Camera Setup Wizard. Simply click the **Start** button to go through the Setup Wizard, which will guide you through the setup process from connecting your hardware to configuring your camera.

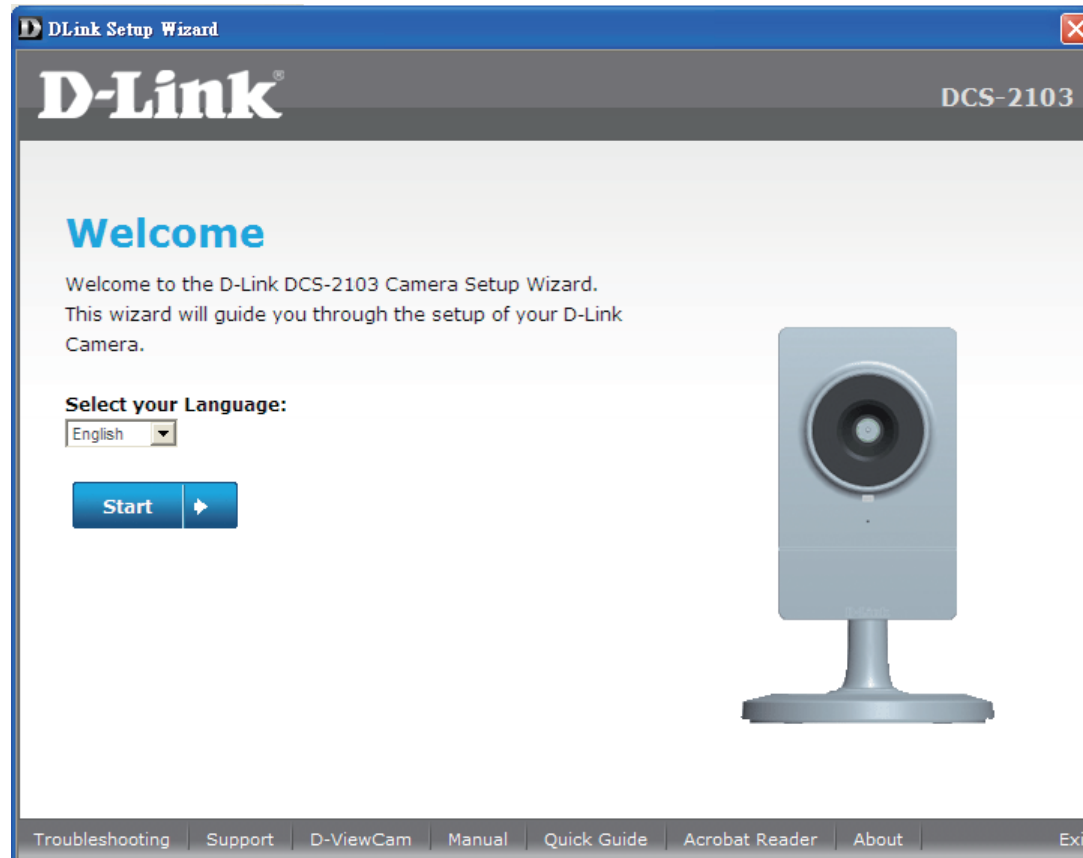

Using the Configuration Menu

After completing the Camera Setup Wizard, you are ready to use your camera. The camera's built-in Web configuration utility is designed to allow you to easily access and configure your DCS-2103. At the end of the wizard, click the **Go To Camera** button, or enter the IP address of your camera into a web browser, such as Internet Explorer. To log in, use the user name **admin** and the password you created in the Installation Wizard. If you did not create a password, the default password is blank. After entering your password, click the **OK** button.

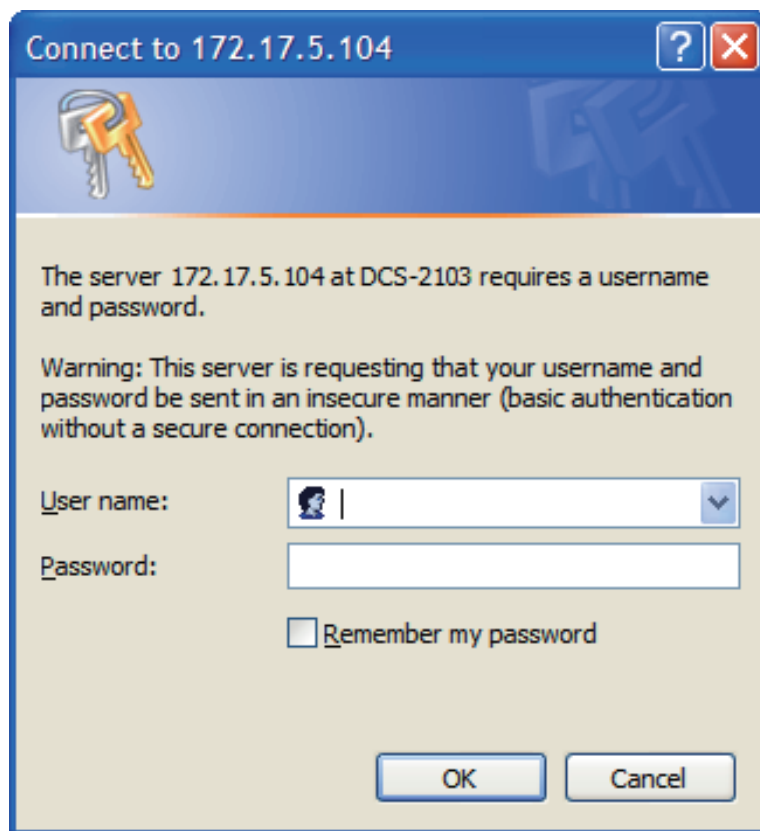

Note: If you are directly connecting your PC to the camera, or if you are using the camera on a closed network, the default IP is **192.168.0.20**.











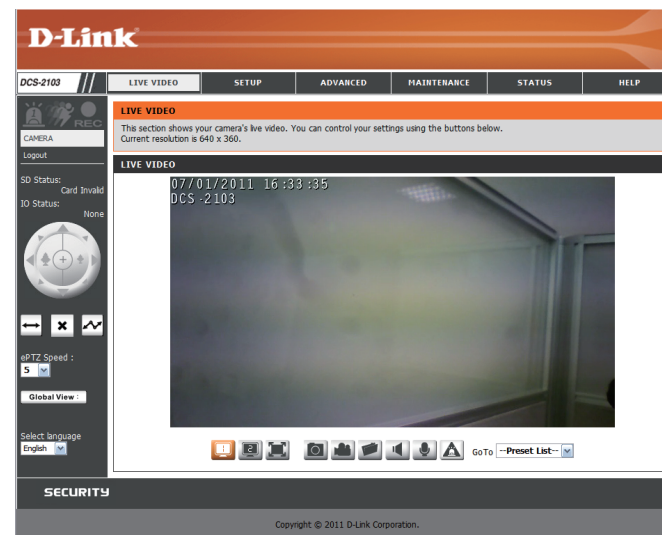

Live Video

This section shows your camera's live video. You may select any of the available icons listed below to operate the camera. You may also select your language using the drop-down menu on the left side of the screen.

You can zoom in and out on the live video image using your mouse. Right-click to zoom out or left-click to zoom in on the image.

	Digital Input Indicator	This indicator will change color when a digital input signal is detected.
	Motion Trigger Indicator	This indicator will change color when a trigger event occurs. Note: The video motion feature for your camera must be enabled.
	Recording Indicator	When a recording is in progress, this indicator will change color.



-  Video Profile 1
-  Video Profile 2
-  Video Profile 3
-  Full screen mode
-  Taking a Snapshot
-  Recording a Video Clip
-  Set a Storage Folder
-  Listen/Stop Listening
-  Talk/Stop Talking
-  Start/Stop Digital Output

	Control Pad	This control pad can be used to pan, tilt, and zoom within the camera's predefined view area, if one has been defined.
---	--------------------	--

Go To: If any presets have been defined, selecting a preset from this list (**Preset List**) will display it.

SD Status: This option displays the status of the SD card. If no SD card has been inserted, this screen will display the message "Card Invalid."

IO Status: This option displays the status of your I/O device if a device has been connected.



PTZ Control: This camera uses electronic pan/tilt/zoom (ePTZ) to select and view areas of interest in the field of view. Please see page 23 for information about setting the frame size and view window area.

ePTZ Speed: You may select a value between 0 and 64. 0 is the slowest and 64 is the fastest.

Global View: This window indicates the total field of view (FOV) of the camera. The red box indicates the visible region of interest (ROI).

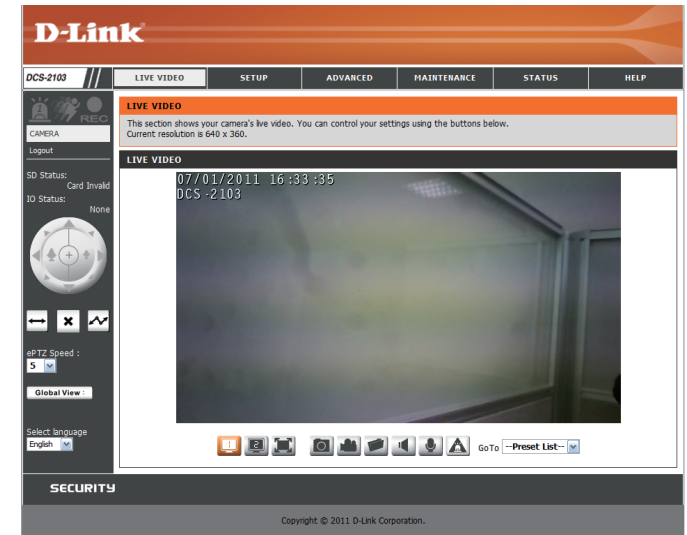
Language: You may select the interface language using this menu.



	Auto Pan	Starts the automatic panning function. The ROI will pan from back and forth within the FOV
	Stop	Stops the camera ePTZ motion
	Preset Path	Starts the camera's motion along the predefined path

Setup Wizard

To configure your Network Camera, click **Internet Connection Setup Wizard**. Alternatively, you may click **Manual Internet Connection Setup** to manually configure your Network Camera and skip to page 22.

To quickly configure your Network Camera's motion detection settings, click **Motion Detection Setup Wizard**. If you want to enter your settings without running the wizard, click **Manual Motion Detection Setup** and skip to page 27.

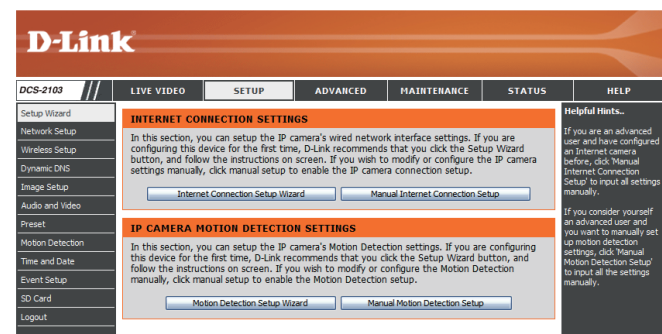

Internet Connection Setup Wizard

This wizard will guide you through a step-by-step process to configure your new D-Link Camera and connect the camera to the internet. Click **Next** to continue.

Note: Select DHCP if you are unsure of which settings to choose.

Click **Next** to continue.

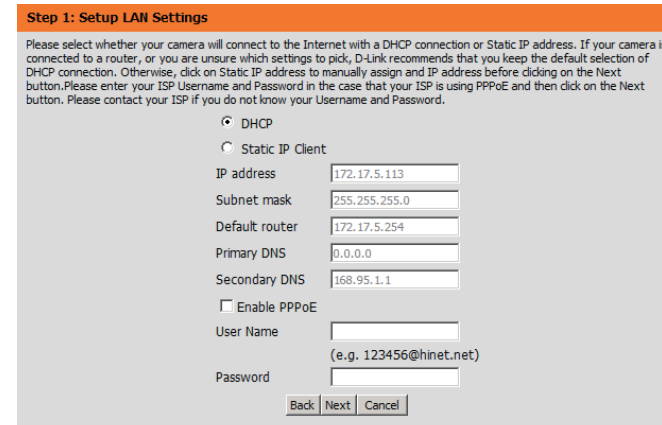
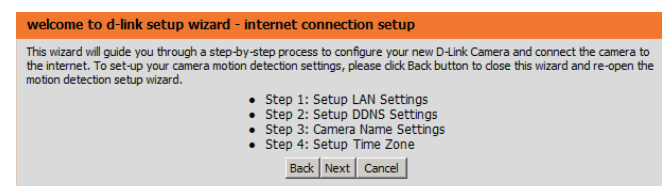

Configuration

Select Static IP if your Internet Service Provider has provided you with connection settings, or if you wish to set a static address within your home network. Enter the correct configuration information and click **Next** to continue.

If you are using PPPoE, select **Enable PPPoE** and enter your user name and password, otherwise click **Next** to continue.

If you have a Dynamic DNS account and would like the camera to update your IP address automatically, Select **Enable DDNS** and enter your host information. Click **Next** to continue.

Enter a name for your camera and click **Next** to continue.

Step 1: Setup LAN Settings

Please select whether your camera will connect to the Internet with a DHCP connection or Static IP address. If your camera is connected to a router, or you are unsure which settings to pick, D-Link recommends that you keep the default selection of DHCP connection. Otherwise, click on Static IP address to manually assign and IP address before clicking on the Next button. Please enter your ISP Username and Password in the case that your ISP is using PPPoE and then click on the Next button. Please contact your ISP if you do not know your Username and Password.

DHCP
 Static IP Client

IP address
Subnet mask
Default router
Primary DNS
Secondary DNS

Enable PPPoE
User Name
(e.g. 123456@hinet.net)
Password

Step 2: Setup DDNS Settings

If you have a Dynamic DNS account and would like the camera to update your IP address automatically, enable DDNS and enter in your host information below. Please click on the Next button to continue.

Enable DDNS

Server Address <<

Host Name
User Name
Password
Verify Password
Timeout (hours)

Step 3: Camera Name Settings

D-Link recommends that you rename your camera for easy accessibility. You can then identify and connect to your camera via this name. Please assign a name of your choice before clicking on the Next button.

IP Camera Name

Configuration

Configure the correct time to ensure that all events will be triggered as scheduled. Click **Next** to continue.

If you have selected DHCP, you will see a summary of your settings, including the camera's IP address. Please write down all of this information as you will need it in order to access your camera.

Click **Apply** to save your settings.

Step 4: Setup Time Zone

Please configure the correct time to ensure that all events are triggered, captured and scheduled at the correct time and day and then click on the Next button.

Time Zone (GMT-08:00) Pacific Time (US & Canada) ▼

Enable Daylight Saving

Back Next Cancel

Step 5: Setup complete

Below is a summary of your camera settings. Click on the Back button to review or modify settings or click on the Apply button if all settings are correct. It is recommended to note down these settings in order to access your camera on the network or via your web browser.

IP Address	DHCP
IP Camera Name	DCS-3710
Time Zone	(GMT+08:00) Taipei
DDNS	Disable
PPPoE	Disable

Back Apply Cancel

Motion Detection Setup Wizard

This wizard will guide you through a step-by-step process to configure your camera's motion detection functions.

Click **Next** to continue.

Step 1

This step will allow you to enable or disable motion detection, specify the detection sensitivity, and adjust the camera's ability to detect movement.

You may specify whether the camera should capture a snapshot or a video clip when motion is detected.

Please see the **Motion Detection** section on page 27 for information about how to configure motion detection.

Step 2

This step allows you to enable motion detection based on a customized schedule. Specify the day and hours. You may also choose to always record motion.

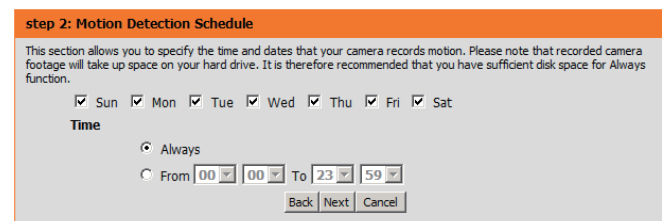
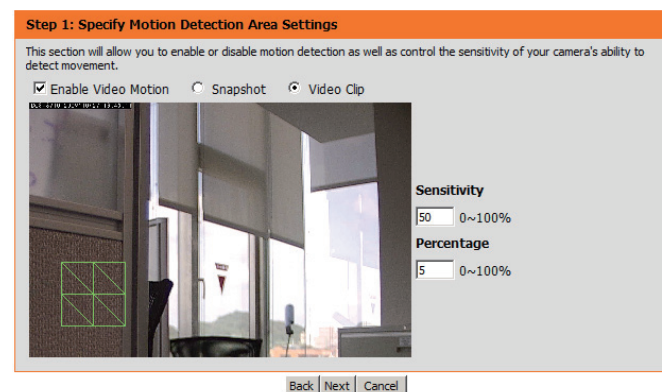
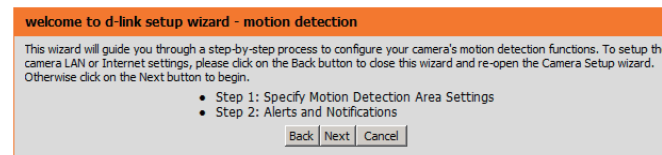

Step 3

This step allows you to specify how you will receive event notifications from your camera. You may choose not to receive notifications, or to receive notifications via e-mail or FTP.

Please enter the relevant information for your e-mail or FTP account.

Click **Next** to continue.

Step 3: Alerts and Notification

This final step allows you to specify how you receive notification of camera events. Choose between an email notification or alternatively you can setup an FTP Notification. You will need your email account settings or FTP details. If you are unsure of this information, please contact your ISP. Once you have entered this information, please click on the Next button.

Do not notify me

Email

Sender email address

Recipient email address

Server address

User name

Password

Port

FTP

Server address

Port

User name

Password

Remote folder name

Step 4

You have completed the Motion Detection Wizard.

Please verify your settings and click **Apply** to save them.

Step 4: Setup Complete

You have completed your camera setup. Please click the Back button if you want to review or modify your settings or click on the Apply button to save and apply your settings.

Motion Detection : Enable

EVENT : Video Clip

Schedule Day : Sun , Mon , Tue , Wed , Thu , Fri , Sat ,

Schedule Time : Always

Alerts and Notification : Email

Please wait a few moments while the camera saves your settings and restarts.

Step 4: Setup Complete

You have completed your camera setup. Please click the Back button if you want to review or modify your settings or click on the Apply button to save and apply your settings.

Changes saved.IP Camera's network is restarting, please wait for 3 seconds ...

Network Setup

Use this section to configure the network connections for your camera. All relevant information must be entered accurately. After making any changes, click the **Save Settings** button to save your changes.

LAN Settings: This section lets you configure settings for your local area network.

DHCP: Select this connection if you have a DHCP server running on your network and would like your camera to obtain an IP address automatically.

Static IP Address: You may obtain a static or fixed IP address and other network information from your network administrator for your camera. A static IP address may simplify access to your camera in the future.

IP Address: Enter the fixed IP address in this field.

Subnet Mask: This number is used to determine if the destination is in the same subnet. The default value is 255.255.255.0.

Default Gateway: The gateway used to forward frames to destinations in a different subnet. Invalid gateway settings may cause the failure of transmissions to a different subnet.

Primary DNS: The primary domain name server translates names to IP addresses.

Secondary DNS: The secondary DNS acts as a backup to the primary DNS.

D-Link

DCS-2103 // LIVE VIDEO SETUP ADVANCED MAINTENANCE STATUS HELP

NETWORK SETUP
You can configure your LAN and Internet settings here.
Save Settings Don't Save Settings

LAN SETTINGS

DHCP
 Static IP Client

IP address: 172.17.5.116
Subnet mask: 255.255.255.0
Default router: 172.17.5.254
Primary DNS: 192.168.168.250
Secondary DNS: 192.168.168.201

Enable UPnP presentation
 Enable UPnP port forwarding
Forwarding Port: 1024 [Test]
Forwarding Status: UPnP forwarding is inactive

PPPoE SETTINGS

Enable Disable

User Name: []
Password: []
Confirm password: []
PPPoE Status: PPPoE is inactive.

HTTP

HTTP port: 80
Access name for stream1: video1.mjpg
Access name for stream2: video2.mjpg

HTTPS

HTTPS port: 443

RTSP

RTSP port: 554
Access name for stream1: live1.sdp
Access name for stream2: live2.sdp

TRAFFIC

Maximum Upload Bandwidth: 0 Kilo Bytes Per Second
Maximum Download Bandwidth: 0 Kilo Bytes Per Second

Save Settings Don't Save Settings

SECURITY

Copyright © 2011 D-Link Corporation.

Helpful Hints...
Select DHCP Connection if you are running a DHCP server on your network and would like an IP address assigned to your IP camera automatically.
UPnP - Enabling UPnP settings will allow you to configure your IP camera as an UPnP device in the network.
PPPoE Setting - If you use the IP camera to connect directly to the Internet, you will need to enter the username and password, which were given to you when you set up your account with your Internet Service Provider. If the camera is behind a router or a gateway, you do not need to configure this setting.
HTTP - HTTP Port is the port you allocate in order to connect to the IP camera via a standard web browser.
HTTPS - HTTPS Port is a IP camera connects it with a PC via a secure web browser.
RTSP - RTSP Port is the port you allocate in order to connect to a IP camera by using streaming mobile device(s), such as a mobile phone or PDA.
Traffic - Specifying the maximum download/upload bandwidth for each socket is useful when connecting your device to a busy or heavily loaded network.
* The value '0' means it will not monitor any traffic.

Enable UPnP: Enabling this setting allows your camera to be configured as a UPnP device on your network.

Enable UPnP Port Forwarding: Enabling this setting allows the camera to add port forwarding entries into the router automatically on a UPnP capable network.

Enable PPPoE: Enable this setting if your network uses PPPoE.

User Name / Password: Enter the username and password for your PPPoE account. Re-enter your password in the Confirm Password field. You may obtain this information from your ISP.

HTTP Port: The default port number is 80.

Access Name for Stream 1~3: The default name is video#.mjpg, where # is the number of the stream.

HTTPS Port: You may use a PC with a secure browser to connect to the HTTPS port of the camera. The default port number is 443.

RTSP Port: The port number that you use for RTSP streaming to mobile devices, such as mobile phones or PDAs. The default port number is 554. You may specify the address of a particular stream. For instance, live1.sdp can be accessed at rtsp://x.x.x.x/video1.sdp where the x.x.x.x represents the ip address of your camera. Specifying the maximum download/upload bandwidth

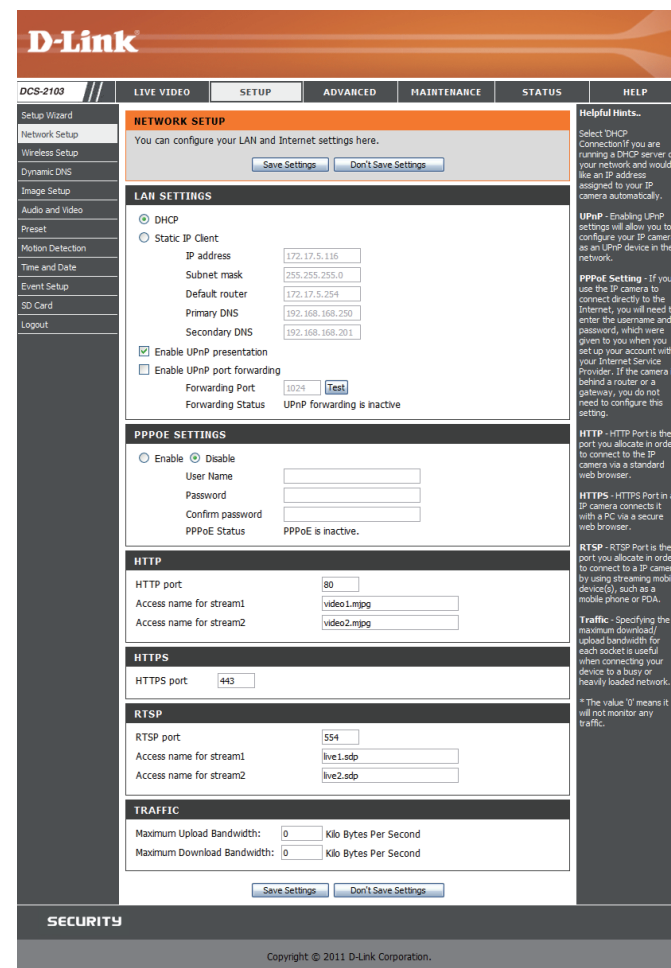

Maximum Upload/Download Bandwidth: for each socket can be useful when connecting your device to a busy or heavily loaded network. Entering a value of '0' indicates that the camera should not monitor bandwidth. Specifying other values will limit the camera's transfer speed to the specified number of kilobytes per second.

DCS-2103 // LIVE VIDEO SETUP ADVANCED MAINTENANCE STATUS HELP

NETWORK SETUP
You can configure your LAN and Internet settings here.

Save Settings Don't Save Settings

LAN SETTINGS

DHCP
 Static IP Client

IP address: 172.17.5.116
Subnet mask: 255.255.255.0
Default router: 172.17.5.254
Primary DNS: 192.168.168.250
Secondary DNS: 192.168.168.201

Enable UPnP presentation
 Enable UPnP port forwarding
Forwarding Port: 1024 [Test]
Forwarding Status: UPnP forwarding is inactive

PPPoE SETTINGS

Enable Disable

User Name: _____
Password: _____
Confirm password: _____
PPPoE Status: PPPoE is inactive.

HTTP

HTTP port: 80
Access name for stream1: video1.mjpg
Access name for stream2: video2.mjpg

HTTPS

HTTPS port: 443

RTSP

RTSP port: 554
Access name for stream1: live1.sdp
Access name for stream2: live2.sdp

TRAFFIC

Maximum Upload Bandwidth: 0 Kilo Bytes Per Second
Maximum Download Bandwidth: 0 Kilo Bytes Per Second

Save Settings Don't Save Settings

SECURITY

Copyright © 2011 D-Link Corporation.

Helpful Hints...
Select DHCP connection if you are running a DHCP server on your network and would like an IP address assigned to your IP camera automatically.
UPnP - Enabling UPnP settings will allow you to configure your IP camera as an UPnP device in the network.
PPPoE Setting - If you use the IP camera to connect directly to the Internet, you will need to enter the username and password, which were given to you when you set up your account with your Internet Service Provider. If the camera is behind a router or a gateway, you do not need to configure this setting.
HTTP - HTTP Port is the port you allocate in order to connect to the IP camera via a standard web browser.
HTTPS - HTTPS Port in a IP camera connects it with a PC via a secure web browser.
RTSP - RTSP Port is the port you allocate in order to connect to a IP camera by using streaming mobile device(s), such as a mobile phone or PDA.
Traffic - Specifying the maximum download/upload bandwidth for each socket is useful when connecting your device to a busy or heavily loaded network.
* The value '0' means it will not monitor any traffic.

Dynamic DNS

DDNS (Dynamic Domain Name Server) will hold a DNS host name and synchronize the public IP address of the modem when it has been modified. A user name and password are required when using the DDNS service. After making any changes, click the **Save Settings** button to save your changes.

Enable DDNS: Select this checkbox to enable the DDNS function.

Server Address: Select your Dynamic DNS provider from the pull down menu or enter the server address manually.

Host Name: Enter the host name of the DDNS server.

User Name: Enter the user name or e-mail used to connect to your DDNS account.

Password: Enter the password used to connect to your DDNS server account.

Timeout: Enter the DNS Timeout values you wish to use.

Status: Indicates the connection status, which is automatically determined by the system.

The screenshot shows the D-Link DCS-2103 web interface. The top navigation bar includes 'LIVE VIDEO', 'SETUP', 'ADVANCED', 'MAINTENANCE', 'STATUS', and 'HELP'. The left sidebar lists various setup options: Setup Wizard, Network Setup, Wireless Setup, Dynamic DNS (selected), Image Setup, Audio and Video, Preset, Motion Detection, Time and Date, Event Setup, SD Card, and Logout. The main content area is titled 'DYNAMIC DNS' and contains the following information:

DYNAMIC DNS

The Dynamic DNS feature allows you to use a domain name that you have purchased (www.yourdomain.com) to access your IP camera with a dynamically assigned IP address. Most broadband Internet service providers assign dynamic (changing) IP addresses. By using a DDNS service, you can enter your domain name to connect to your IP camera no matter what your IP address is.

Sign up for D-Link's Free DDNS service at www.DLinkDDNS.com.

Buttons: Save Settings, Don't Save Settings

DYNAMIC DNS SETTING

Enable DDNS:

Server Address: << >>

Host Name:

User Name:

Password:

Verify Password:

Timeout: (hours)

Status: Active

Buttons: Save Settings, Don't Save Settings

Helpful Hints...

Dynamic DNS is useful if you have a DSL or Cable service provider that changes your modem IP address periodically. This will allow you to assign a website domain name to your IP camera instead of connecting through an IP address.

Image Setup

In this section, you may configure the video image settings for your camera. A preview of the image will be shown in Live Video.

Enable Privacy Mask: The Privacy Mask setting allows you to specify up to 3 rectangular areas on the camera's image to be blocked/excluded from recordings and snapshots.

You may click and drag the mouse cursor over the camera image to draw a mask area.

Right clicking on the camera image brings up the following menu options:

Disable All: Disables all mask areas

Enable All: Enables all mask areas

Reset All: Clears all mask areas.

Anti Flicker: If the video flickers, try enabling this setting.

Mirror: This will mirror the image horizontally.

Flip: This will flip the image vertically. When turning Flip on, you may want to consider turning Mirror on as well.

Power Line: Select the frequency used by your power lines to avoid interference or distortion.

White Balance: Use the dropdown box to change white balance settings to help balance colors for different environments. You can choose from Auto, Outdoor, Indoor, Fluorescent, and Push Hold.

The screenshot shows the D-Link DCS-2103 web interface. The top navigation bar includes 'LIVE VIDEO', 'SETUP', 'ADVANCED', 'MAINTENANCE', 'STATUS', and 'HELP'. The left sidebar lists various setup options like 'Setup Wizard', 'Network Setup', 'Wireless Setup', 'Dynamic DNS', 'Image Setup', 'Audio and Video', 'Preset', 'Motion Detection', 'Time and Date', 'Event Setup', 'SD Card', and 'Logout'. The main content area is titled 'IMAGE SETUP' and contains a 'LIVE VIDEO' section with a 'Enable Privacy Mask Setting' checkbox and a video preview. Below the preview is the 'IMAGE SETTINGS' section, which includes radio buttons for 'Anti Flicker', 'Mirror', and 'Flip'; a 'Power Line' section with '60 Hz' and '50 Hz' options; a 'White Balance' dropdown set to 'Auto'; an 'Exposure Mode' dropdown set to 'Auto' with a 'Max Gain' of '24 dB'; and sliders for 'Denoise', 'Brightness', 'Contrast', 'Saturation', and 'Sharpness'. A 'Reset Default' button is located at the bottom of the settings section. The right sidebar, titled 'Helpful hints', provides instructions for 'Privacy Mask', 'Anti Flicker', 'Mirror', 'Flip', and 'Power Line'.

Exposure Mode: Changes the exposure mode. Use the dropdown box to set the camera for Indoor, Outdoor, or Night environments, or to Moving to capture moving objects. The Low_Noise option will focus on creating a high-quality picture without noise. You can also create 3 different custom exposure modes. The Max Gain setting will allow you to control the maximum amount of gain to apply to brighten the picture.

Denoise: This setting controls the amount of noise reduction that will be applied to the picture.

Brightness: Adjust this setting to compensate for backlit subjects.

Contrast: Adjust this setting to alter the color intensity/strength.

Saturation: This setting controls the amount of coloration, from grayscale to fully saturated.

Sharpness: Specify a value from 0 to 8 to specify how much sharpening to apply to the image.

Reset Default: Click this button to reset the image to factory default settings.



Audio and Video

You may configure up to 3 video profiles with different settings for your camera. Hence, you may set up different profiles for your computer and mobile display. In addition, you may also configure the two-way audio settings for your camera. After making any changes, click the **Save Settings** button to save your changes.

Number of active profiles: You can use the dropdown box to set up to 3 active profiles.

Aspect ratio: Set the aspect ratio of the video to 4:3 standard or 16:9 widescreen.

Mode: Set the video codec to be used to JPEG, MPEG-4, or H.264.

Frame size / View window area: Frame size determines the total capture resolution, and View window area determines the Live Video viewing window size. If the Frame size is larger than the Live Video size, you can use the ePTZ controls to look around.

16:9	1280 x 800, 1280 x 720, 800 x 450, 640 x 360, 480 x 270, 320 x 176, 176 x 144
4:3	1024 x 768, 800 x 600, 640 x 480, 480 x 360, 320 x 240, 176 x 144

Note: If your View window area is the same as your Frame size, you will not be able to use the ePTZ function.

Maximum frame rate: A higher frame rate provides smoother motion for videos, and requires more bandwidth. Lower frame rates will result in stuttering motion, and requires less bandwidth.

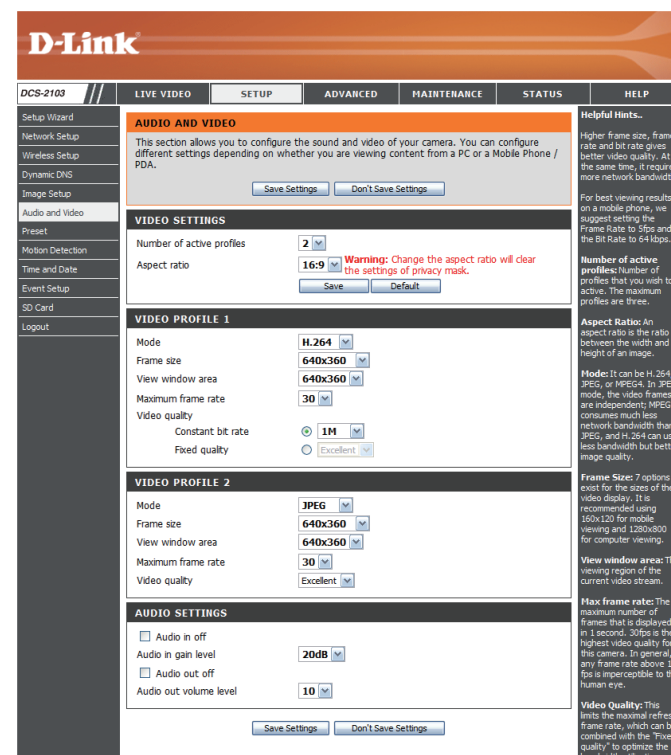

Video Quality: This limits the maximum frame rate, which can be combined with the "Fixed quality" option to optimize the bandwidth utilization and video quality. If fixed bandwidth utilization is desired regardless of the video quality, choose "Constant bit rate" and select the desired bandwidth.

Constant bit rate: The bps will affect the bit rate of the video recorded by the camera. Higher bit rates result in higher video quality.

Fixed quality: Select the image quality level for the camera to try to maintain. High quality levels will result in increased bit rates.

Audio in off: Ticking this checkbox will mute incoming audio.

Audio in gain level: This setting controls the amount of gain applied to incoming audio to increase its volume.

Audio out off: Ticking this checkbox will mute outgoing audio.

Audio out volume level: This setting controls the amount of gain applied to outgoing audio to increase its volume.

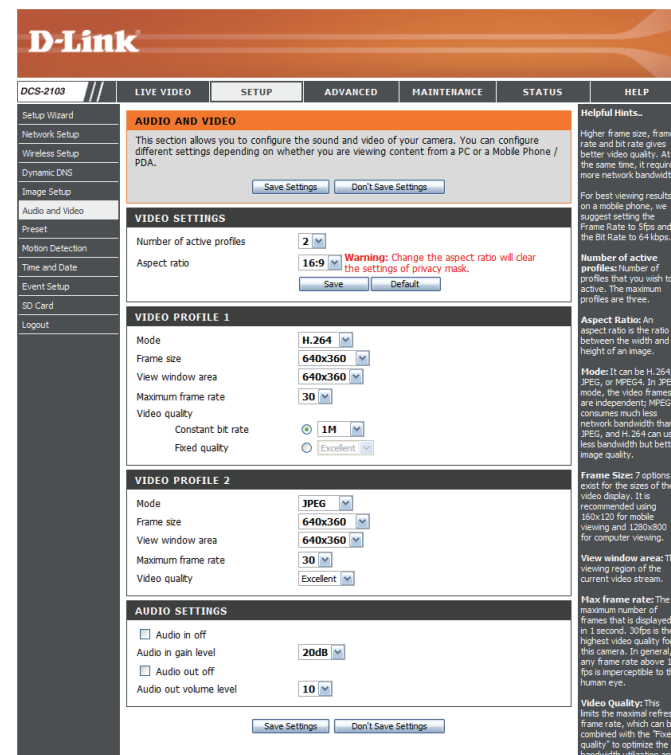

Preset

This screen allows you to set preset points for the ePTZ function of the camera, which allows you to look around the camera's viewable area by using a zoomed view. Presets allow you to quickly go to and view a specific part of the area your camera is covering, and you can create preset sequences, which will automatically change the camera's view between the different presets according to a defined order and timing you can set.

Note: If your View window area is the same as your Frame size, you will not be able to use the ePTZ function. For more details, refer to "Audio and Video" on page 23.

Video Profile: This selects which video profile to use. For more information, refer to "Audio and Video" on page 23.

ePTZ Speed: Select your Dynamic DNS provider from the pull down menu or enter the server address manually.

Arrow Buttons and Home Button: Use these buttons to move to a specific part of the viewing area, which you can then set as a preset. Click the Home button to return to the center of the viewing area.

Input Preset Name: Enter the name of the preset you want to create, then click the **Add** button to make a new preset. If an existing preset has been selected from the Preset List, you can change its name by typing in a new name, then clicking the **Rename** button.

Preset List: Click this dropdown box to see a list of all the presets that have been created. You can select one, then click the **GoTo** button to change the displayed camera view to the preset. Clicking the **Remove** button will delete the currently selected preset.



Preset Sequence: This section allows you to create a preset sequence, which automatically moves the camera's view between a set of preset views.

To add a preset to the sequence, select it from the dropdown box at the bottom of this window, set the **Dwell time** to determine how long the camera view will stay at that preset, then click the **Add** button. The preset name will appear in the list, followed by the dwell time to view that preset for.

You can rearrange your presets in the sequence by selecting a preset in the sequence, then clicking the arrow buttons to move it higher or lower in the current sequence.

Clicking the trash can button will remove the currently selected preset from the sequence.

If you want to change the dwell time for a preset, select it from the list, enter a new dwell time, then click the **Update** button.

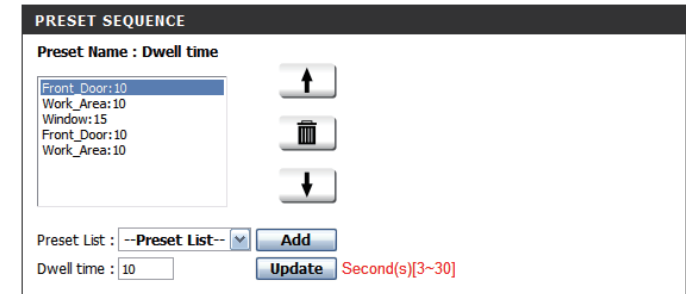

The screenshot shows a web interface titled "PRESET SEQUENCE". At the top, it says "Preset Name : Dwell time". Below this is a list of presets: "Front_Door:10", "Work_Area:10", "Window:15", "Front_Door:10", and "Work_Area:10". To the right of the list are three buttons: an up arrow, a trash can, and a down arrow. Below the list is a "Preset List" dropdown menu with "--Preset List--" selected, an "Add" button, and a "Dwell time" input field with the value "10" and an "Update" button. To the right of the "Update" button is a red text label "Second(s)[3~30]".

Motion Detection

Enabling Video Motion will allow your camera to use the motion detection feature. You may draw a finite motion area that will be used for monitoring. After making any changes, click the **Save Settings** button to save your changes.

Enable Video Motion: Select this box to enable the motion detection feature of your camera.

Sensitivity: Specifies the measurable difference between two sequential images that would indicate motion. Please enter a value between 0 and 100.

Percentage: Specifies the amount of motion in the window being monitored that is required to initiate an alert. If this is set to 100%, motion is detected within the whole window will trigger a snapshot.

Draw Motion Area: Draw the motion detection area by dragging your mouse in the window (indicated by the red square).

Erase Motion Area: To erase a motion detection area, simply click on the red square that you wish to remove.

Right clicking on the camera image brings up the following menu options:

Select All: Draws a motion detection area over the entire screen.

Clear All: Clears any motion detection areas that have been drawn.

Restore: Restores the previously specified motion detection areas.

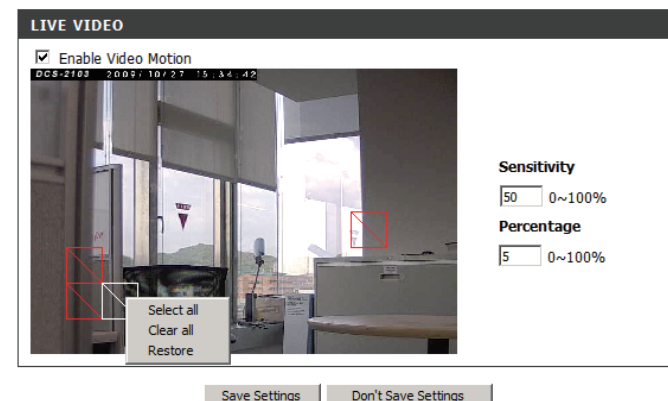
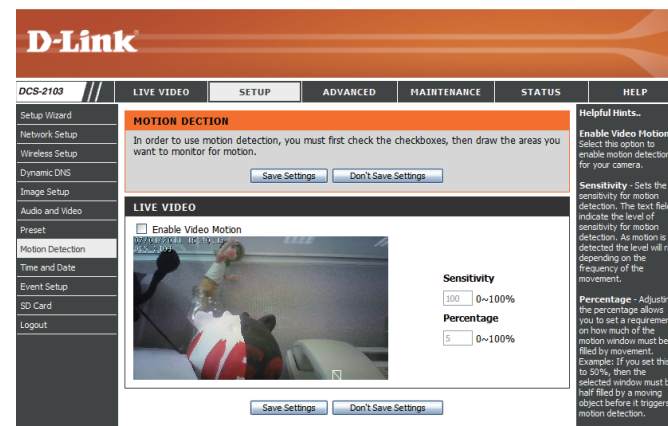

Time and Date

This section allows you to automatically or manually configure, update, and maintain the internal system clock for your camera. After making any changes, click the **Save Settings** button to save your changes.

Time Zone: Select your time zone from the drop-down menu.

Enable Daylight Saving: Select this to enable Daylight Saving Time.

Auto Daylight Saving: Select this option to allow your camera to configure the Daylight Saving settings automatically.

Set Date and Time Manually: Selecting this option allows you to configure the Daylight Saving date and time manually.

Offset: Sets the amount of time to be added or removed when Daylight Saving is enabled.

Synchronize with NTP Server: Enable this feature to obtain time automatically from an NTP server.

NTP Server: Network Time Protocol (NTP) synchronizes the DCS-2103 with an Internet time server. Choose the one that is closest to your location.

Set the Date and Time Manually: This option allows you to set the time and date manually.

Copy Your Computer's Time Settings: This will synchronize the time information from your PC.

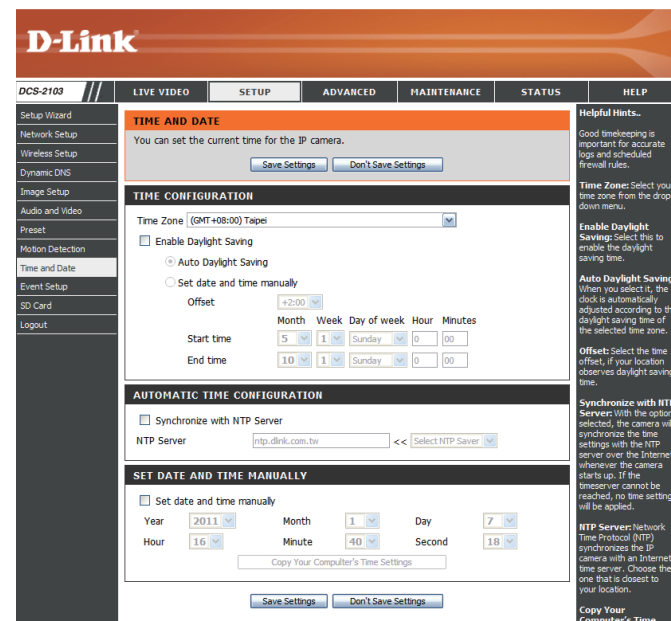

Event Setup

The Event Setup page includes 4 different sections.

- Event
- Server
- Media
- Recording

1. To add a new item - "event, server or media," click **Add**. A screen will appear and allow you to update the fields accordingly.
2. To delete the selected item from the pull-down menu of event, server or media, click **Delete**.
3. Click on the item name to pop up a window for modifying.

Note: You can add up to four events, five servers, and five media fields.

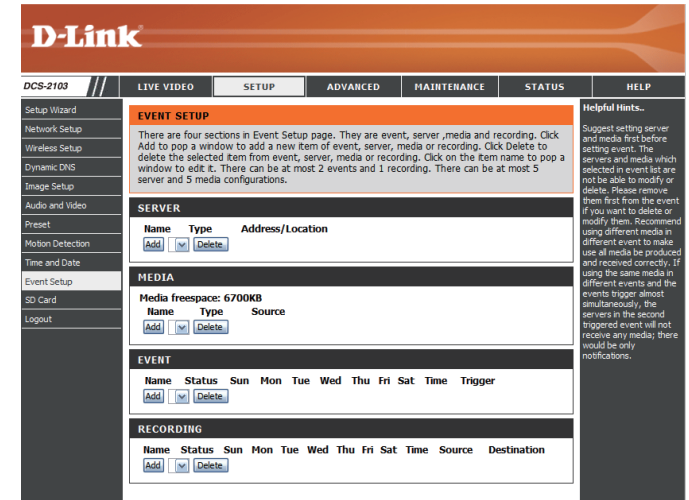

Application

In a typical application, when motion is detected, the DCS-2103 Network Camera sends images to a FTP server or via e-mail as notifications. As shown in the illustration below, an event can be triggered by many sources, such as motion detection or external digital input devices. When an event is triggered, a specified action will be performed. You can configure the Network Camera to send snapshots or videos to your e-mail address or FTP site.

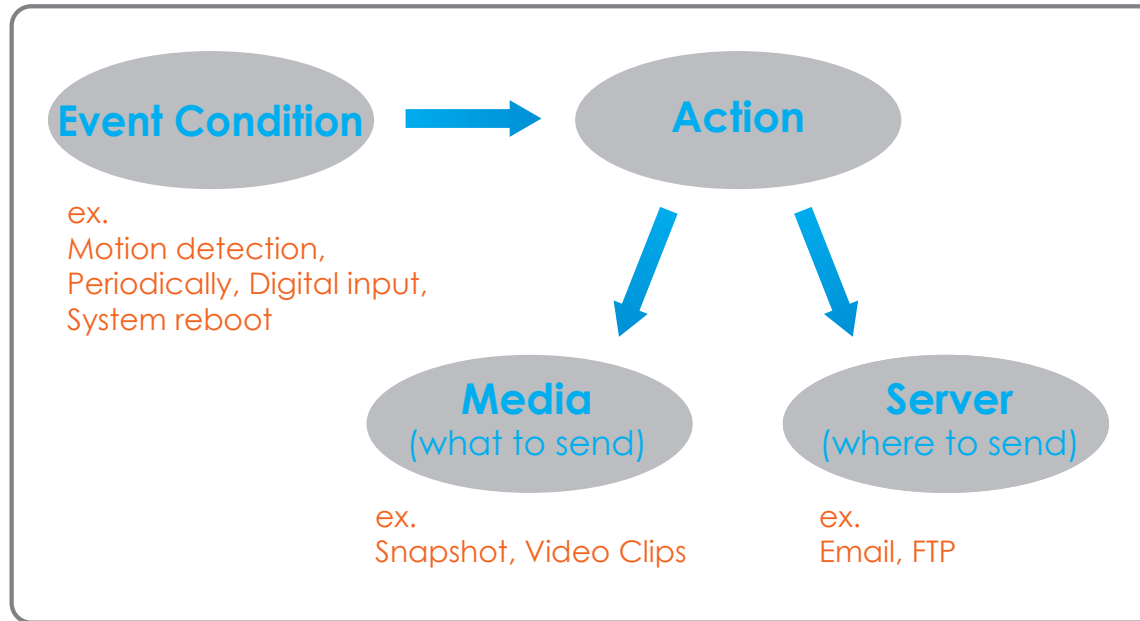

To start plotting an event, it is suggested to configure server and media columns first so that the Network Camera will know what action shall be performed when a trigger is activated.

Add Server

You can configure up to 5 servers to save snapshots and/or video to. After making any changes, click the **Save Settings** button to save your changes.

Server Name: Enter the unique name of your server.

E-mail: Enter the configuration for the target e-mail server account.

FTP: Enter the configuration for the target FTP server account.

Network Storage: Specify a network storage device. Only one network storage device is supported.

SD Card: Use the camera's onboard SD card storage.



Add Media

There are three types of media, **Snapshot**, **Video Clip**, and **System Log**. After making any changes, click the **Save Settings** button to save your changes.

Media Name: Enter an unique name for media type you want to create.

Snapshot: Select this option to set the media type to snapshots.

Source: Set the video profile to use as the media source. Refer to "Audio and Video" on page 23 for more information on video profiles.

Send pre-event image(s) [0~4]: Set the number of pre-event images to take. Pre-event images are images taken before the main event snapshot is taken.

Send post-event image(s) [0~7]: Set the number of post-event images to take. Post-event images are images taken after the main event snapshot is taken. You can set up to 7 post-event images to be taken.

File name prefix: The prefix name will be added on the file name.

Add date and time suffix to file name: Check it to add timing information as file name suffix.

Video clip: Select this option to set the media type to video clips.

Source: Set the video profile to use as the media source. Refer to "Audio and Video" on page 23 for more information on video profiles.

Pre-event recording: This sets how many seconds to record before the main event video clip starts. You can record up to 4 seconds of pre-event video.

Maximum duration: Set the maximum length of video to record for your video clips.

Maximum file size: Set the maximum file size to record for your video clips.

File name prefix: This is the prefix that will be added to the filename of saved video clips.

System log: Select this option to set the media type to system logs. This will save the event to the camera system log, but will not record any snapshots or video.

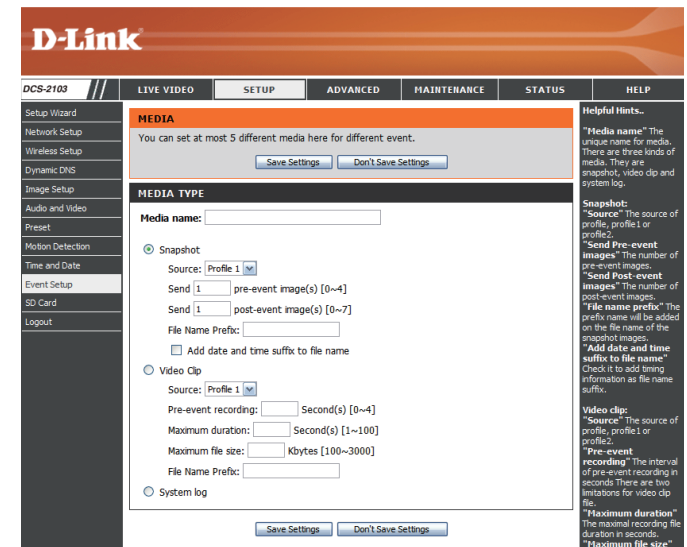

Add Event

Create and schedule up to 3 events with their own settings here. After making any changes, click the **Save Settings** button to save your changes.

Event name: Enter a name for the event.

Enable this event: Select this box to activate this event.

Priority: Set the priority for this event. The event with higher priority will be executed first.

Delay: Select the delay time before checking the next event. It is being used for both events of motion detection and digital input trigger.

Trigger: Specify the input type that triggers the event.

Video Motion Detection: Motion is detected during live video monitoring. Select the windows that need to be monitored.

Periodic: The event is triggered in specified intervals. The trigger interval unit is in minutes.

Digital input: The external trigger input to the camera.

System Boot: Triggers an event when the system boots up.

Network Lost: Triggers an event when if the network connection is lost.



Time: Select **Always** or enter the time interval.

Trigger D/O: Select to trigger the digital output for a specific number of seconds when an event occurs.

Server: Specify the location where the event information should be saved to.

The screenshot shows the 'Event Setup' configuration page for the D-Link DCS-2103. The page is divided into several sections:

- EVENT:** Contains an 'Event name' text field, an 'Enable this event' checkbox, a 'Priority' dropdown menu (set to 'normal'), and a 'Delay for' field (set to '10') with the unit 'seconds before detecting next event [For motion detection and digital input]'. There are 'Save Settings' and 'Don't Save Settings' buttons at the bottom of this section.
- TRIGGER:** Includes radio buttons for 'Video motion detection' (selected), 'Periodic', 'Digital input', 'System boot', and 'Network lost'. The 'Periodic' option has a sub-field 'Trigger every 1 minutes'.
- EVENT SCHEDULE:** Shows a row of checkboxes for days of the week (Sun, Mon, Tue, Wed, Thu, Fri, Sat), all of which are checked. Below this is a 'Time' section with radio buttons for 'Always' (selected) and 'From 00:00 To 23:59'.
- ACTION:** Contains a checkbox for 'Trigger D/O for' followed by a text field (set to '1') and the unit 'seconds'. There are 'Save Settings' and 'Don't Save Settings' buttons at the bottom of this section.

On the right side of the page, there is a 'Helpful Hints...' section with several informational paragraphs:

- Priority:** The event with higher priority will be executed first.
- Delay second(s) before detecting next event:** The delay to check next event. It is used in motion detection and digital input trigger type. There are five kinds of trigger supported.
- Video motion detections:** Select the windows which need to be monitored.
- Periodic:** The event is triggered in specified intervals. The unit of trigger interval is minute.
- Digital input:** The event is triggered when the DI status changed by external device.
- System boot:** The event is triggered when the system boot up.
- Network lost:** The event is triggered when the network service is not available or disconnection.
- Sun ~ Sat:** Select the days of the week to perform the event.
- Time:** show 'Always' or input the time interval. The default action are triggering DO and storing media on SD card. If there are servers configured, the user can select them from 'Server'.

Add Recording

Here you can configure and schedule the recording settings. After making any changes, click the **Save Settings** button to save your changes.

Recording entry name: The unique name of the entry.

Enable this recording: Select this to enable the recording function.

Priority: Set the priority for this entry. The entry with a higher priority value will be executed first.

Source: The source of the stream.

Recording schedule: Scheduling the recording entry.

Recording settings: Configuring the setting for the recording.

Destination: Select the folder where the recording file will be stored.

Total cycling recording size: Please input a HDD volume between 1MB and 200GB for recording space. The recording data will replace the oldest record when the total recording size exceeds this value. For example, if each recording file is 6MB, and the total cyclic recording size is 600MB, then the camera will record 100 files in the specified location (folder) and then will delete the oldest file and create new file for cyclic recording.

Please note that if the free HDD space is not enough, the recording will stop. Before you set up this option please make sure your HDD has enough space, and it is better to not save other files in the same folder as recording files.

The screenshot shows the D-Link DCS-2103 web interface for configuring recording settings. The interface is divided into several sections:

- RECORDING:** This section allows users to enable or disable recording. It includes a checkbox for "Enable this recording", a "Priority" dropdown menu (set to "normal"), and a "Source" dropdown menu (set to "Profile 1"). There are "Save Settings" and "Don't Save Settings" buttons.
- RECORDING SCHEDULE:** This section allows users to schedule recording. It includes a "Time" section with radio buttons for "Always" and "From" (set to "00:00" to "23:59"). There are "Save Settings" and "Don't Save Settings" buttons.
- RECORDING SETTINGS:** This section allows users to configure recording settings. It includes a "Destination" dropdown menu (set to "None"), a "Total cycling recording size" field (set to "1000" kbytes), a "Size of each file for recording" field (set to "200" kbytes), and a "File Name Prefix" field. There are "Save Settings" and "Don't Save Settings" buttons.
- Helpful Hints...:** This section provides additional information about recording options and schedules. It includes a "Recording schedule" section with a "Recording schedule" dropdown menu and a "From" field. It also includes a "Total cycling recording size" section with a "Total cycling recording size" field.

Size of each file for recording: File size for each recording file. You may input the value in the range of 200-5000.

File Name Prefix: The prefix name will be added on the file name of the recording file(s).

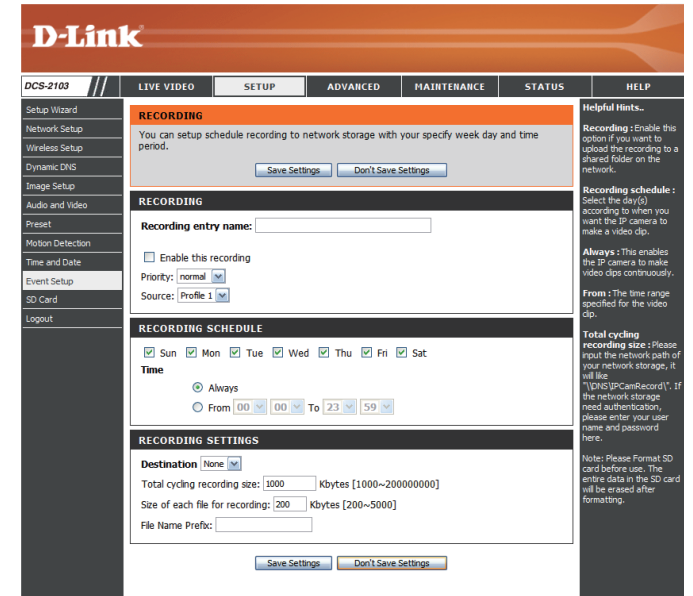

SD Card

Here you may browse and manage the recorded files which are stored on the SD card.

Format SD Card: Click this icon to automatically format the SD card and create "picture" & "video" folders.

View Recorded Picture: If the picture files are stored on the SD card, click on the picture folder and choose the picture file you would like to view.

Playback Recorded Video: If video files are stored on the SD card, click on the video folder and choose the video file you would like to view.

Refresh: Reloads the file and folder information from the SD card.

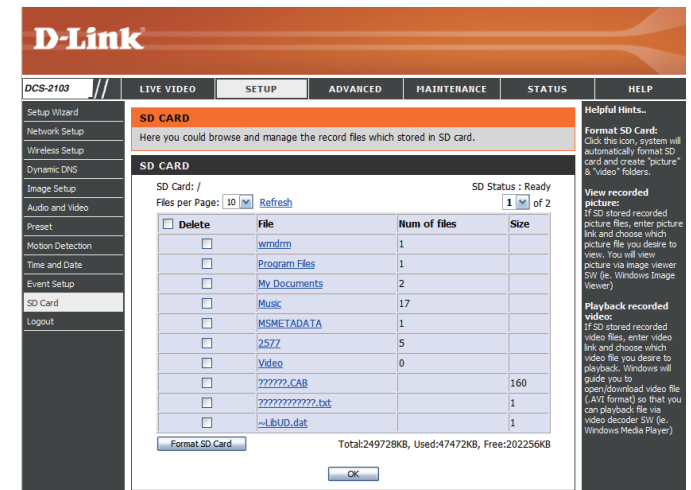

Advanced

Digital Input/Output

This screen allows you to control the behavior of digital input and digital output devices. The I/O connector provides the physical interface for digital output (DO) and digital input (DI) that is used for connecting a variety of external alarm devices such as IR-Sensors and alarm relays. The digital input is used for connecting external alarm devices and once triggered images will be taken and e-mailed. After making any changes, click the **Save Settings** button to save your changes.

Select DI/ or D/O Mode: The camera will send a signal when an event is triggered, depending upon the type of device connected to the DI circuit.

N.C. stands for **Normally Closed**. This means that the normal state of the circuit is closed. Therefore events are triggered when the device status changes to "Open."

N.O. stands for **Normally Open**. This means that the normal state of the circuit is open. Therefore events are triggered when the device status changes to "Closed."

LED: You may specify whether or not to illuminate the LED on the side of the camera.

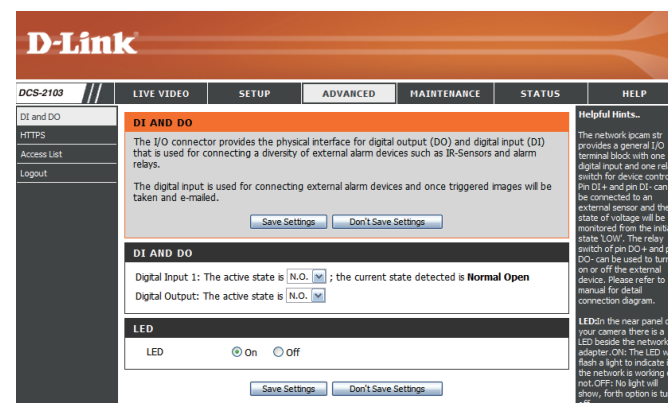

HTTPS

This page allows you to install and activate an HTTPS certificate for secure access to your camera. After making any changes, click the **Save Settings** button to save your changes.

Enable HTTPS Secure Connection: Enable the HTTPS service.

Create Certificate Method: Choose the way the certificate should be created. Three options are available:

- Create a self-signed certificate automatically
- Create a self-signed certificate manually
- Create a certificate request and install

Status: Displays the status of the certificate.

Note: The certificate cannot be removed while the HTTPS is still enabled. To remove the certificate, you must first uncheck **Enable HTTPS secure connection**.

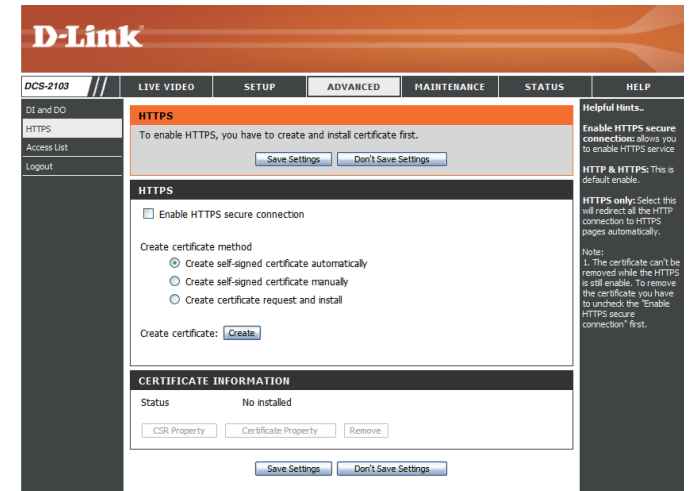

Access List

Here you can set access permissions for users to view your DCS-2103.

Allow list: The list of IP addresses that have the access right to the camera.

Start IP address: The starting IP Address of the devices (such as a computer) that have permission to access the video of the camera. Click Add to save the changes made.

Note: A total of seven lists can be configured for both columns.

End IP address: The ending IP Address of the devices (such as a computer) that have permission to access the video of the camera.

Delete allow list: Remove the customized setting from the Allow List.

Deny list: The list of IP addresses that have no access rights to the camera.

Delete deny list: Remove the customized setting from the Delete List.

For example:

When the range of the Allowed List is set from 1.1.1.0 to 192.255.255.255 and the range of the Denied List is set from 1.1.1.0 to 170.255.255.255. Only users with IPs located between 171.0.0.0 and 192.255.255.255 can access the Network Camera.

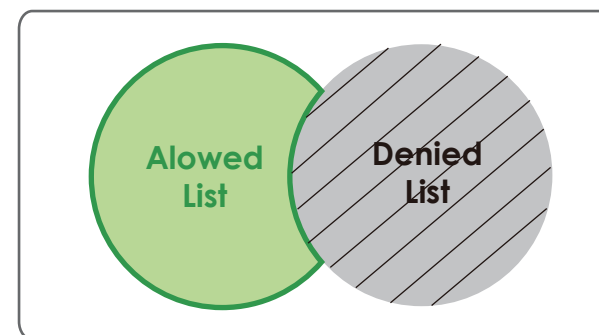
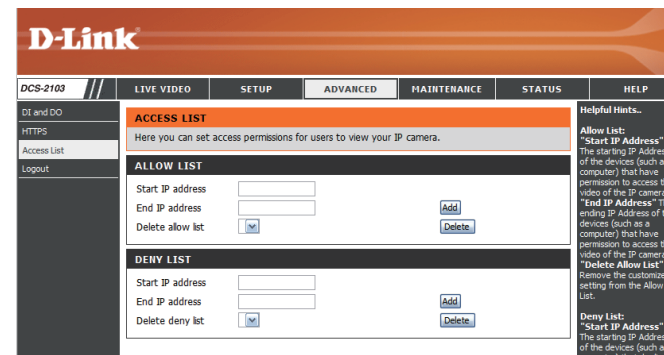

Maintenance

Device Management

You may modify the name and administrator's password of your camera, as well as add and manage the user accounts for accessing the camera. You may also use this section to create a unique name and configure the OSD settings for your camera.

Admin Password Setting: Set a new password for the administrator's account.

Add User Account: Add new user account.

User Name: The user name for the new account.

Password: The password for the new account.

User List: All the existing user accounts will be displayed here. You may delete accounts included in the list, but please reserve at least one as guest.

Camera Name: Create a unique name for your camera that will be added to the file name prefix when creating a snapshot or a video clip.

Enable OSD: Select this option to enable the On-Screen Display feature for your camera.

Label: Enter a label for the camera.

Show Time: Select this option to enable the time-stamp display on the video screen.

The screenshot displays the D-Link web interface for the DCS-2103 camera. The top navigation bar includes 'LIVE VIDEO', 'SETUP', 'ADVANCED', 'MAINTENANCE', 'STATUS', and 'HELP'. The 'MAINTENANCE' tab is active, showing the 'ADMIN' section. The 'ADMIN' section contains the following sub-sections:

- ADMIN PASSWORD SETTING:** Fields for 'New Password' and 'Retype Password', both with a '63 characters maximum' limit and a 'Save' button.
- ADD USER ACCOUNT:** Fields for 'User Name' (20 users maximum), 'New Password' (63 characters maximum), and 'Retype Password', with an 'Add' button.
- USER LIST:** A table with a 'User Name' column and a 'Delete' button.
- DEVICE SETTING:** Fields for 'IP camera Name' (DCS-2130, 63 characters maximum), 'Enable OSD' (checked), 'Label' (DCS-2130, 63 characters maximum), and 'Show time' (checked), with a 'Save' button.

On the right side, there is a 'Helpful Hints...' section with text: 'Enabling OSD, the IP camera name and time will be displayed on the video screen for the user.' and a security warning: 'For security purposes, it is recommended that you change the password for your administrator account. Be sure to write down the new password to avoid having to reset the IP camera in the event that it is forgotten.'

Backup and Restore

In this section, you may backup, restore and reset the camera configuration, or reboot the camera.

Save To Local Hard Drive: You may save and document your current settings into your computer.

Local From Local Hard Drive: Locate a pre-saved configuration by clicking **Browse** and then restore the pre-defined settings to your camera by clicking **Load Configuration**.

Restore to Factory Default: You may reset your camera and restore the factory settings by clicking **Restore Factory Defaults**.

Reboot Device: This will restart your camera.

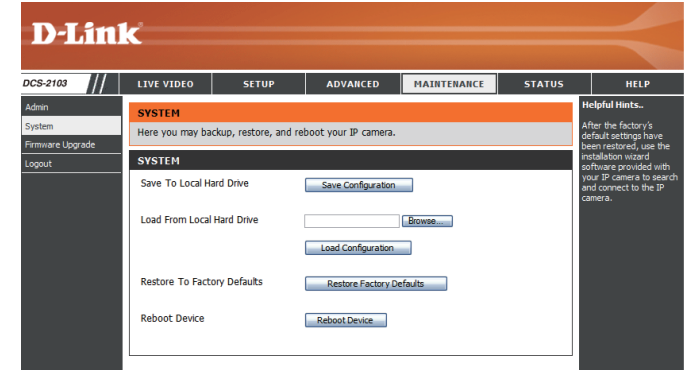

Firmware Upgrade

The camera's current firmware version will be displayed on this screen. You may visit the D-Link Support Website to check for the latest available firmware version.

To upgrade the firmware on your DCS-2103, please download and save the latest firmware version from the D-Link Support Page to your local hard drive. Locate the file on your local hard drive by clicking the **Browse** button. Select the file and click the **Upload** button to start upgrading the firmware.

Current Firmware Version: Displays the detected firmware version.

Current Product Name: Displays the camera model name.

File Path: Locate the file (upgraded firmware) on your hard drive by clicking **Browse**.

Upload: Uploads the new firmware to your camera.

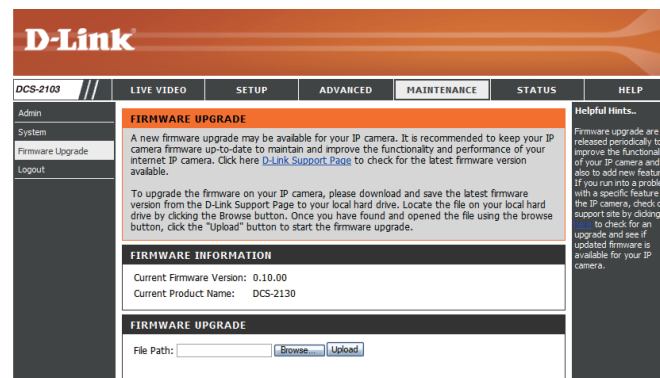

Status

Device Info

This page displays detailed information about your device and network connection.

D-Link

DCS-2103 // LIVE VIDEO SETUP ADVANCED MAINTENANCE STATUS HELP

Device Info
Log
Logout

DEVICE INFO

All of your network connection details are displayed on this page. The firmware version is also displayed here.

INFORMATION

IP camera Name	DCS-2103
Time & Date	Fri Jan 7 16:48:32 2011
Firmware Version	0.10.00
MAC Address	AA:BB:CC:11:22:33
IP Address	172.17.5.116
IP Subnet Mask	255.255.255.0
Default Gateway	172.17.5.254
Primary DNS	192.168.168.250
Secondary DNS	192.168.168.201
PPPoE	Disable
DDNS	Disable

Helpful Hints..

This page displays all the information about the IP camera and network settings.

Logs

This page displays the log information of your camera. You may download the information by clicking **Download**. You may also click **Clear** to delete the saved log information.

D-Link

DCS-2103 // LIVE VIDEO SETUP ADVANCED MAINTENANCE STATUS HELP

Device Info
Log
Logout

SYSTEM LOG
The system log records IP camera events that have occurred.

CURRENT LOG

1. 2011-01-07 16:29:50 admin LOGIN OK FROM 172.17.5.123
2. 2011-01-07 16:27:53 IP CAMERA ACQUIRE DHCP IP 172.17.5.116
3. 2011-01-07 16:27:47 SYSTEM SET DCPower ON
4. 2011-01-07 16:27:42 SYSTEM BOOTING
5. 2011-01-01 00:27:49 NETWORK LOST
6. 2011-01-01 00:03:25 admin FROM 172.17.5.150 SET VIDEO CODEC Need Reset
7. 2011-01-01 00:03:25 admin FROM 172.17.5.150 SET PROFILE1 Constant Bit Rate
8. 2011-01-01 00:03:25 admin FROM 172.17.5.150 SET PROFILE1 Frame Size 640x360 Need Reset
9. 2011-01-01 00:01:53 admin LOGIN OK FROM 172.17.5.150
10. 2011-01-01 00:00:11 IP CAMERA ACQUIRE DHCP IP 172.17.5.158
11. 2011-01-01 00:00:04 SYSTEM SET DCPower ON
12. 2011-01-01 00:00:00 SYSTEM BOOTING
13. 2011-05-17 15:41:47 admin LOGIN OK FROM 172.17.5.130
14. 2011-05-17 15:40:15 IP CAMERA ACQUIRE DHCP IP 172.17.5.141
15. 2011-05-17 15:40:08 SYSTEM SET DCPower ON
16. 2011-05-17 15:40:03 SYSTEM BOOTING
17. 2011-05-11 17:24:01 admin LOGIN OK FROM 10.1.1.3
18. 2011-05-11 17:23:48 IP CAMERA ACQUIRE DHCP IP 10.1.1.4
19. 2011-05-11 17:23:42 SYSTEM SET DCPower ON
20. 2011-05-11 17:23:37 SYSTEM BOOTING

First Page Previous 20 Next 20
Clear Download

Helpful Hints..
You can save the log to your local hard IP camera by clicking the Download button, and you can clear the log by clicking on the Clear button.

Help

This page provides helpful information regarding camera operation.

The screenshot displays the D-Link web interface for the DCS-2103 camera. At the top, the D-Link logo is visible. Below it is a navigation bar with tabs for LIVE VIDEO, SETUP, ADVANCED, MAINTENANCE, STATUS, and HELP. The HELP tab is currently selected. On the left side, there is a sidebar with 'Help' and 'Logout' options. The main content area is divided into three sections: a 'HELP' section with a bulleted list of menu items, a 'LIVE VIDEO' section with a 'Camera' link, and a 'SETUP' section with a bulleted list of configuration options.

D-Link						
DCS-2103	LIVE VIDEO	SETUP	ADVANCED	MAINTENANCE	STATUS	HELP
Help Logout	HELP <ul style="list-style-type: none"> LIVE VIDEO SETUP MAINTENANCE ADVANCED STATUS 					
	LIVE VIDEO <ul style="list-style-type: none"> Camera 					
	SETUP <ul style="list-style-type: none"> Setup Wizard Network Setup Dynamic DNS Image Setup Audio and Video Preset Motion Detection Time and Date Event Setup SD Card 					

DI/DO Input Specifications

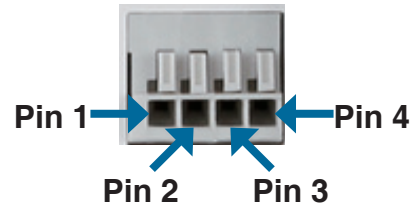

PIN	FUNCTION	NOTE
1	Digital Out (DO)	Uses an open-drain NFET transistor with the source connected to GND in camera. If used with an external relay, a diode must be connected in parallel with the load for protection against voltage transients. Max loading is 100 mA.
2	Digital In (DI)	A switch from DI to DC 5 V, activated by setting NO. or NC.
3	DC5V OUTPUT	DC 5 V Output / Max. 100 mA
4	GND	GND

Internal 5V Power

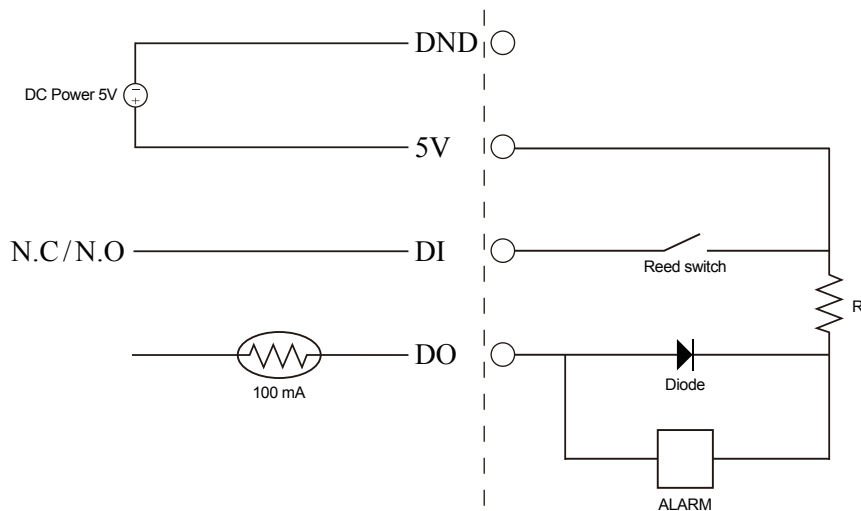

External 3~12V Power

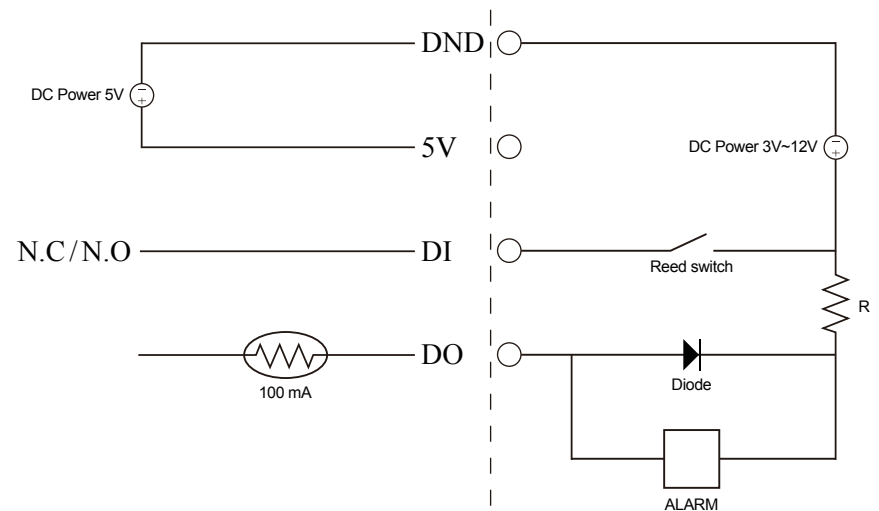

Technical Specifications

Camera	Camera Hardware Profile	<ul style="list-style-type: none"> ▪ 1/4" 1 Megapixel progressive CMOS sensor ▪ Minimum illumination 1.0 lux ▪ 10x digital zoom ▪ Fixed length 3.45 mm 	<ul style="list-style-type: none"> ▪ Aperture F2.0 ▪ Angle of view: (H) 57.8° (V) 37.8° (D) 66°
	Image Features	<ul style="list-style-type: none"> ▪ Configurable image size, quality, frame rate, and bit rate ▪ Time stamp and text overlays ▪ Configurable motion detection windows 	<ul style="list-style-type: none"> ▪ 3 configurable privacy mask zones ▪ Configurable shutter speed, brightness, saturation, contrast, and sharpness
	Video Compression	<ul style="list-style-type: none"> ▪ Simultaneous H.264/MPEG-4/MJPEG format compression ▪ JPEG for still image ▪ H.264/MPEG-4 multicast streaming 	<ul style="list-style-type: none"> ▪ H.264/MPEG-4 multicast streaming
	Video Resolution	16:9 - 1280 x 800, 1280 x 720, 800 x 450, 640 x 360, 480 x 270, 320 x 176, 176 x 144 at frame rates up to 30 fps 4:3 - 1024 x 768, 800 x 600, 640 x 480, 480 x 360, 320 x 240, 176 x 144 at frame rates up to 30 fps	
	Audio Support	G.726	
	External Device Interface	<ul style="list-style-type: none"> ▪ 1 DI / 1 DO ▪ Micro SD card slot 	<ul style="list-style-type: none"> ▪ Built-in microphone ▪ 3.5mm audio output jack
Network	Network Protocols	IPv4, TCP/IP, UDP, ICMP, DHCP Client, NTP Client (D-Link), DNS Client, DDNS Client (D-Link), SMTP Client, FTP Client, HTTP / HTTPS, Samba Client, PPPoE, UPnP Port Forwarding, RTP / RTSP/ RTCP, IP filtering, 3GPP, IGMP, ONVIF Compliant	
	Security	<ul style="list-style-type: none"> ▪ Administrator and user group protection ▪ Password authentication 	<ul style="list-style-type: none"> ▪ HTTP and RTSP digest encryption

Technical Specifications

System Management	System Requirements for Web Interface	<ul style="list-style-type: none"> ▪ Operating System: Microsoft Windows 7/Vista/XP/2000 ▪ Browser: Internet Explorer, Firefox, Netscape, Opera
	Event Management	<ul style="list-style-type: none"> ▪ Motion detection ▪ Event notification and upload snapshots/video clips via HTTP, SMTP, or FTP ▪ Supports multiple HTTP, SMTP, and FTP servers ▪ Multiple event notifications ▪ Multiple recording methods for easy backup
	Remote Management	<ul style="list-style-type: none"> ▪ Configuration accessible via web browser ▪ Take snapshots/video clips and save to local hard drive or NAS via web browser
	Mobile Support	Windows 7/Vista/XP system, Pocket PC, or mobile phone with 3GPP playback support
	D-ViewCam™ System Requirements	<ul style="list-style-type: none"> ▪ Operating System: Microsoft Windows 7/Vista/XP ▪ Web Browser: Internet Explorer 6 or higher ▪ Protocol: Standard TCP/IP
	D-ViewCam™ Software Functions	<ul style="list-style-type: none"> ▪ Remote management/control of up to 32 cameras ▪ Viewing of up to 32 cameras on one screen ▪ Supports all management functions provided in web interface ▪ Scheduled motion triggered, or manual recording options
General	Power Input	5 V DC 1.2 A, 50/60 Hz
	Max. Power Consumption	DCS-2103: 2 watts DCS-2130: 2.5 watts
	Operating Temperature	0 to 40 °C (32 to 104 °F)
	Storage Temperature	-20 to 70 °C (-4 to 158 °F)
	Humidity	20% to 80% non-condensing
	Weight	DCS-2103: 68 g DCS-2130: 69 g
	Certifications	CE, CE LVD, FCC (Class B), C-Tick

* This device complies with part 15 of the FCC Rules.

Operation is subject to the following two conditions:

(1) This device may not cause harmful interference.

(2) This device must accept any interference received, including interference that may cause undesired operation.

