



# User Manual

## Wireless AC1750 Dual Band Gigabit Cloud Router

DIR-868L

---

# Preface

D-Link reserves the right to revise this publication and to make changes in the content hereof without obligation to notify any person or organization of such revisions or changes.

## Manual Revisions

Revision	Date	Description
1.0	April 19, 2013	• Initial release for Revision A1

## Trademarks

D-Link and the D-Link logo are trademarks or registered trademarks of D-Link Corporation or its subsidiaries in the United States or other countries. All other company or product names mentioned herein are trademarks or registered trademarks of their respective companies.

Copyright © 2013 by D-Link Systems, Inc.

All rights reserved. This publication may not be reproduced, in whole or in part, without prior expressed written permission from D-Link Systems, Inc.

# Table of Contents

<b>Preface</b> .....	<b>i</b>	PPTP .....	31
Manual Revisions .....	i	L2TP .....	33
Trademarks .....	i	DS-Lite .....	35
<b>Product Overview</b> .....	<b>1</b>	Internet Connection Setup Wizard.....	36
Package Contents.....	1	Wireless Settings .....	41
System Requirements .....	2	Wireless Connection Setup Wizard.....	42
Introduction .....	3	Add Wireless Device with WPS Wizard .....	44
Hardware Overview .....	4	Manual Wireless Settings .....	46
Connections .....	4	802.11n/g (2.4GHz).....	46
LEDs .....	5	802.11ac/n/a (5GHz) .....	47
<b>Installation</b> .....	<b>6</b>	Wireless Security .....	48
Before you Begin.....	6	What is WPA? .....	48
Wireless Installation Considerations.....	7	WPA/WPA2-Personal (PSK) .....	49
Connect to your Network .....	8	Configure WPA/WPA2-Enterprise (RADIUS).....	50
Connect to an Existing Router .....	11	Network Settings .....	52
<b>Configuration</b> .....	<b>13</b>	Router Settings .....	52
Quick Setup Wizard.....	14	DHCP Server Settings.....	53
QRS Mobile App .....	21	DHCP Reservation .....	55
SharePort Mobile App .....	22	Storage .....	56
Web-based Configuration Utility .....	26	Access Files from the Internet .....	57
Internet Connection Setup .....	27	Media Server.....	58
Static (assigned by ISP) .....	28	IPv6 .....	59
Dynamic (Cable) .....	29	IPv6 Internet Connection Setup Wizard .....	61
PPPoE (DSL).....	30	IPv6 Manual Setup.....	66
		Auto Detection .....	66
		Static IPv6 .....	67

Autoconfiguration .....	68	Time .....	98
PPPoE.....	69	SysLog .....	99
IPv6 in IPv4 Tunneling .....	71	Email Settings.....	100
6 to 4 Tunneling.....	72	System .....	101
6rd .....	73	Firmware .....	102
Local Connectivity .....	74	Language Pack Upgrade .....	102
mydlink Settings .....	75	Dynamic DNS .....	103
Advanced.....	76	System Check.....	105
Virtual Server .....	76	Schedules .....	106
Port Forwarding .....	77	Status .....	107
Application Rules.....	78	Device Info .....	107
QoS Engine.....	79	Logs.....	108
Network Filters.....	81	Statistics .....	109
Access Control.....	82	Internet Sessions.....	110
Access Control Wizard .....	82	Wireless.....	111
Website Filters.....	85	Routing .....	112
Inbound Filters.....	86	IPv6 .....	113
Firewall Settings.....	87	IPV6 Routing .....	114
Routing .....	89	Support .....	115
Advanced Wireless .....	90	<b>Connect a Wireless Client to your Router .....</b>	<b>116</b>
Wi-Fi Protected Setup (WPS) .....	91	WPS Button.....	116
WPS Button .....	92	Windows® 8.....	117
Advanced Network Settings .....	93	Windows® 7.....	119
Guest Zone .....	94	WPA/WPA2 .....	119
IPv6 Firewall .....	95	WPS.....	122
IPv6 Routing .....	96	Windows Vista® .....	126
Tools .....	97	WPA/WPA2 .....	127
Admin.....	97		

WPS/WCN 2.0 .....	129
Windows® XP.....	130
WPA/WPA2 .....	131
<b>Troubleshooting .....</b>	<b>133</b>
Reset Router/Forgot Password .....	134
<b>Wireless Basics .....</b>	<b>137</b>
What is Wireless?.....	138
Tips.....	140
Wireless Modes.....	141
<b>Networking Basics .....</b>	<b>142</b>
Check your IP address.....	142
Windows® 8 Users.....	142
Windows® 7/Vista® Users.....	142
Windows® XP Users .....	142
Statically Assign an IP Address .....	143
Windows® 8 Users .....	143
Windows® 7/ Vista® Users .....	144
Windows® XP Users .....	145
<b>Technical Specifications .....</b>	<b>146</b>
<b>Contacting Technical Support .....</b>	<b>148</b>
<b>GPL Code Statement.....</b>	<b>149</b>
<b>Warranty.....</b>	<b>161</b>
<b>Registration .....</b>	<b>168</b>

# Package Contents



DIR-868L Wireless AC1750 Dual Band Gigabit Cloud Router



Power Adapter

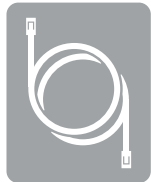

Ethernet Cable



Wi-Fi Configuration Card



Quick Install Guide

If any of the above items are missing, please contact your reseller.

**Note:** Using a power supply with a different voltage rating than the one included with the DIR-868L will cause damage and void the warranty for this product.

# System Requirements

<b>Network Requirements</b>	<ul style="list-style-type: none"><li>• An Ethernet-based broadband modem</li></ul>
<b>Web-based Configuration Utility Requirements</b>	<p><b>Computer with the following:</b></p> <ul style="list-style-type: none"><li>• Windows®, Macintosh, or Linux-based operating system</li><li>• An installed Ethernet adapter or wireless adapter</li></ul> <p><b>Supported Browsers:</b></p> <ul style="list-style-type: none"><li>• Internet Explorer 7 or higher</li><li>• Firefox</li><li>• Safari 4 or higher</li><li>• Chrome</li></ul> <p><b>Windows® Users:</b> Make sure you have the latest version of Java installed. Visit <a href="http://www.java.com">www.java.com</a> to download the latest version.</p>
<b>mydlink Requirements</b>	<ul style="list-style-type: none"><li>• iPhone/iPad/iPod Touch (iOS 3.0 or higher)</li><li>• Android device (1.6 or higher)</li><li>• Computer with the following browser requirements:<ul style="list-style-type: none"><li>• Internet Explorer 7 or higher</li><li>• Firefox</li><li>• Safari 5 or higher</li><li>• Chrome</li></ul></li></ul> <p><small>iPhone, iPad, and iPod touch are registered trademarks of Apple Inc. Android is a trademark of Google, Inc.</small></p>

# Introduction

The DIR-868L Wireless AC1750 Dual Band Gigabit Cloud Router provides revolutionary Gigabit 802.11ac wireless speed - up to 1750Mbps – for flawless HD video streaming to multiple devices.

With ground-breaking mydlink Cloud Services, you can monitor your home network from anywhere on your iPhone, iPad and Android device. See websites that are being visited, block unwanted devices and receive automatic email alerts when unauthorized connections are attempted.

With SharePort Mobile, wirelessly access your media on your iPhone, iPad, or Android device from any connected USB drive. Best of all, the apps for network management and file access are free.

\* Maximum wireless signal rate derived from IEEE Standard 802.11ac (draft), 802.11a, 802.11g, and 802.11n specifications. Actual data throughput will vary. Network conditions and environmental factors, including volume of network traffic, building materials and construction, and network overhead, lower actual data throughput rate. Environmental conditions will adversely affect wireless signal range.



# Hardware Overview

## Connections

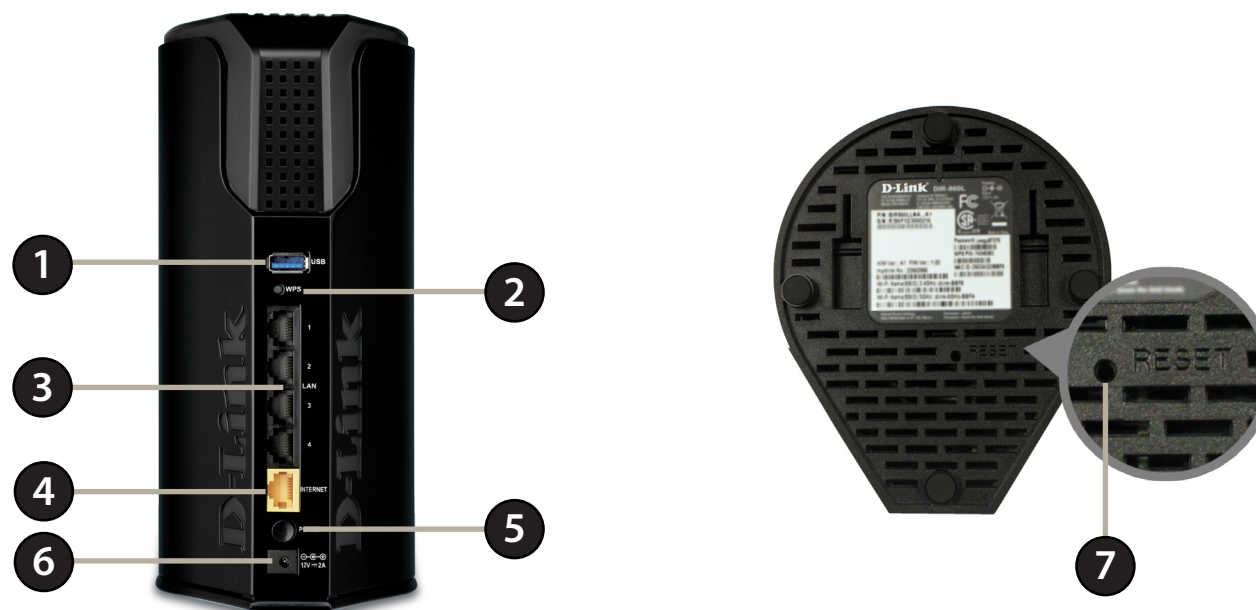

1	USB Port	Connect a USB flash drive to share content throughout your network.
2	WPS Button	Press to start the WPS process. The Power LED will blink during this process.
3	LAN Ports (1-4)	Connect 10/100/1000 Ethernet devices such as computers, switches, storage (NAS) devices, and game consoles.
4	Internet Port	Using an Ethernet cable, connect your broadband modem to this port.
5	Power Button	Press the power button to power on and off.
6	Power Receptor	Receptor for the supplied power adapter.
7	Reset Button	Press and hold the reset button with a paper clip for ten seconds to reset the router to the factory default settings.

# Hardware Overview

## LEDs

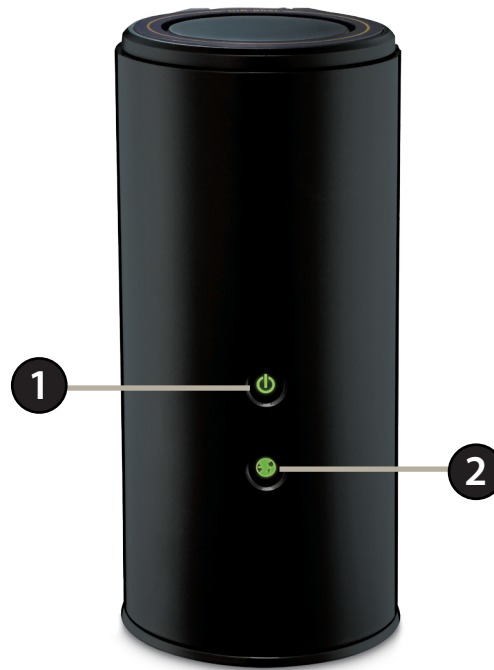

<b>1</b>	Power LED	A solid green light indicates a proper connection to the power supply. The light will be solid orange during boot-up and will blink green during the WPS process.
<b>2</b>	Internet LED	A solid light indicates a connection to the Internet port. If the LED is orange, the connection is good but the router cannot connect to the Internet. If this LED is blinking orange, this indicates that the "on demand" connection type is set and the Internet connection is idle.

# Installation

This section will walk you through the installation process. Placement of the router is very important. Do not place the router in an enclosed area such as a closet, cabinet, or in the attic or garage.

## Before you Begin

- Please configure the router with the computer that was last connected directly to your modem.
- **Users with DSL providers** - If you are using a PPPoE connection, you will need your PPPoE user name and password. If you do not have this information, contact your Internet provider. Do not proceed until you have this information.
- **Users with Cable providers** - Make sure you unplug the power to your modem. In some cases, you may need to turn it off for up to 5 minutes.
- **Advanced Users** - If your ISP provided you with a modem/router combo, you will need to set it to “bridge” mode so the DIR-868L router can work properly. Please contact your ISP or refer to the user manual for your modem/router device.

# Wireless Installation Considerations

The D-Link wireless router lets you access your network using a wireless connection from virtually anywhere within the operating range of your wireless network. Keep in mind, however, that the number, thickness and location of walls, ceilings, or other objects that the wireless signals must pass through, may limit the range. Typical ranges vary depending on the types of materials and background RF (radio frequency) noise in your home or business. The key to maximizing wireless range is to follow these basic guidelines:

1. Keep the number of walls and ceilings between the D-Link router and other network devices to a minimum - each wall or ceiling can reduce your adapter's range from 3-90 feet (1-30 meters.) Position your devices so that the number of walls or ceilings is minimized.
2. Be aware of the direct line between network devices. A wall that is 1.5 feet thick (.5 meters), at a 45-degree angle appears to be almost 3 feet (1 meter) thick. At a 2-degree angle it looks over 42 feet (14 meters) thick! Position devices so that the signal will travel straight through a wall or ceiling (instead of at an angle) for better reception.
3. Building Materials make a difference. A solid metal door or aluminum studs may have a negative effect on range. Try to position access points, wireless routers, and computers so that the signal passes through drywall or open doorways. Materials and objects such as glass, steel, metal, walls with insulation, water (fish tanks), mirrors, file cabinets, brick, and concrete will degrade your wireless signal.
4. Keep your product away (at least 3-6 feet or 1-2 meters) from electrical devices or appliances that generate RF noise.
5. If you are using 2.4GHz cordless phones or X-10 (wireless products such as ceiling fans, lights, and home security systems), your wireless connection may degrade dramatically or drop completely. Make sure your 2.4GHz phone base is as far away from your wireless devices as possible. The base transmits a signal even if the phone is not in use.

# Connect to your Network

1. Turn off and unplug your DSL or Cable modem. This is required.

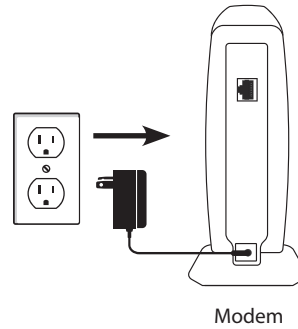

2. Connect an Ethernet cable from the Internet port of the router to the Ethernet port on your DSL or Cable modem.

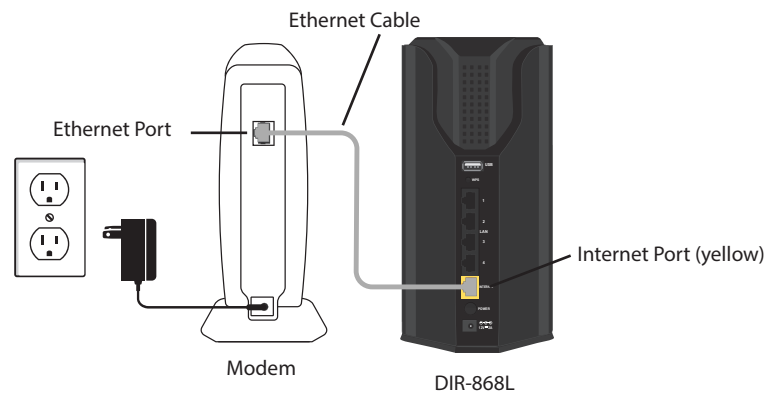

3. Connect another Ethernet cable from the Ethernet port on your computer to one of the LAN ports on the router.

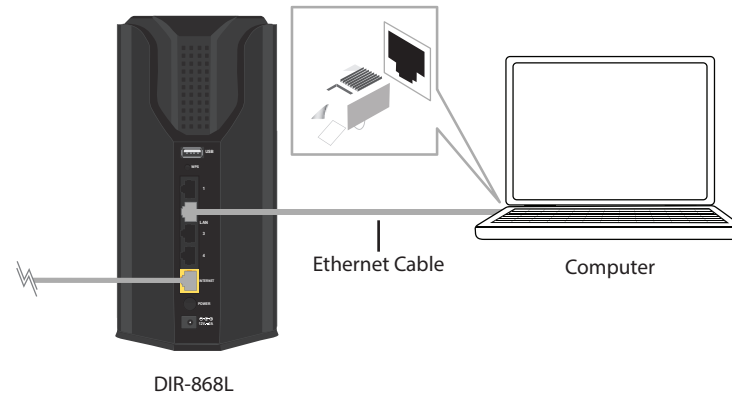

4. Plug the power back into your DSL or Cable modem. Please wait about one minute before continuing.

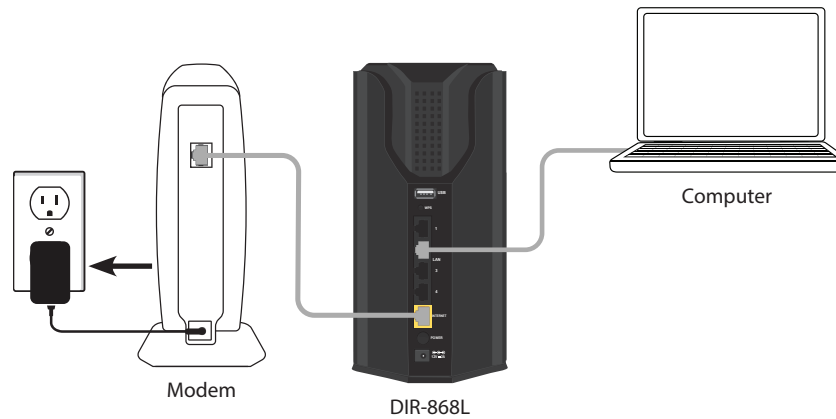

5. Plug the power adapter into your router and connect to an available power outlet or surge protector. If the Power LED does not light up, press the Power button on the back of the router.

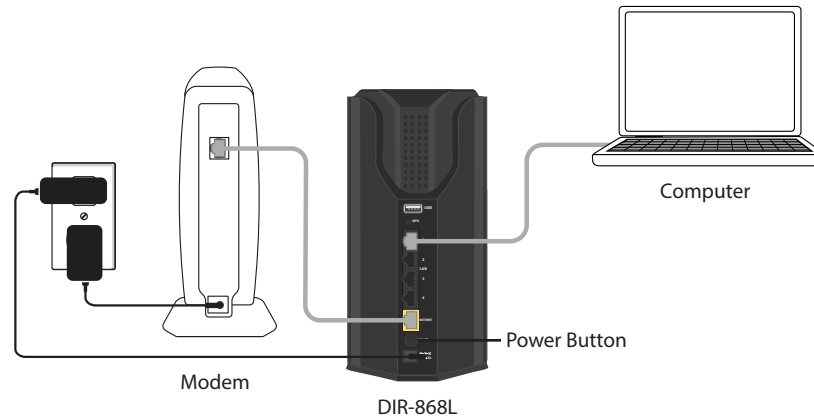

6. After the router has powered up, verify that the power (green) and Internet (orange or green) LEDs are both lit. Please skip to page 13 to configure your router and use the manual setup procedure to configure your network and wireless settings. If you did not connect to the Internet, use the D-Link Setup Wizard (refer to page 14).

# Connect to an Existing Router

**Note:** *It is strongly recommended to replace your existing router with the DIR-868L instead of using both. If your modem is a combo router, you may want to contact your ISP or manufacturer's user guide to put the router into Bridge mode, which will 'turn off' the router (NAT) functions.*

If you are connecting the DIR-868L router to an existing router to use as a wireless access point and/or switch, you will have to do the following to the DIR-868L before connecting it to your network:

- Disable UPnP™
- Disable DHCP
- Change the LAN IP address to an available address on your network. The LAN ports on the router cannot accept a DHCP address from your other router.

To connect to another router, please follow the steps below:

1. Plug the power into the router. Connect one of your computers to the router (LAN port) using an Ethernet cable. Make sure your IP address on the computer is 192.168.0.xxx (where xxx is between 2 and 254). Please see the **Networking Basics** section for more information. If you need to change the settings, write down your existing settings before making any changes. In most cases, your computer should be set to receive an IP address automatically in which case you will not have to do anything to your computer.
2. Open a web browser, enter **http://192.168.0.1** (or **http://dlinkrouter.local./**) and press **Enter**. When the login window appears, set the user name to **Admin** and leave the password box empty. Click **Log In** to continue.
3. Click on **Advanced** and then click **Advanced Network**. Uncheck the **Enable UPnP** checkbox. Click **Save Settings** to continue.
4. Click **Setup** and then click **Network Settings**. Uncheck the **Enable DHCP Server** checkbox. Click **Save Settings** to continue.



5. Under Router Settings, enter an available IP address and the subnet mask of your network. Click **Save Settings** to save your settings. Use this new IP address to access the configuration utility of the router in the future. Close the browser and change your computer's IP settings back to the original values as in Step 1.
6. Disconnect the Ethernet cable from the router and reconnect your computer to your network.
7. Connect an Ethernet cable in one of the **LAN** ports of the router and connect it to your other router. Do not plug anything into the Internet (WAN) port of the D-Link router.
8. You may now use the other 3 LAN ports to connect other Ethernet devices and computers. To configure your wireless network, open a web browser and enter the IP address you assigned to the router. Refer to the **Configuration** and **Wireless Security** sections for more information on setting up your wireless network.

# Configuration

There are several different ways you can configure your router to connect to the Internet and connect to your clients:

- **QRS Mobile App** - Use your iPhone, iPad, or Android device to configure your router. Refer to page 21
- **D-Link Setup Wizard** - This wizard will launch when you log into the router for the first time. Refer to page 14.
- **Manual Setup** - Log into the router and manually configure your router (advanced users only). Refer to page 27.

# Quick Setup Wizard

If this is your first time installing the router, launch your web browser (e.g., Internet Explorer), and you will automatically be directed to the **Wizard Setup Screen**.

If you have already configured your settings and you would like to access the configuration utility, please refer to page 26.

If this is your first time logging into the router, this wizard will start automatically.

This wizard is designed to guide you through a step-by-step process to configure your new D-Link router and connect to the Internet.

Click **Next** to continue.

Please wait while your router detects your internet connection type. If the router detects your Internet connection, you may need to enter your ISP information such as username and password (PPPoE).

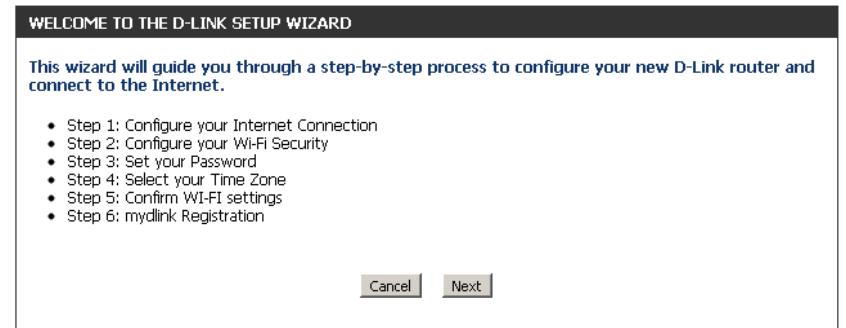
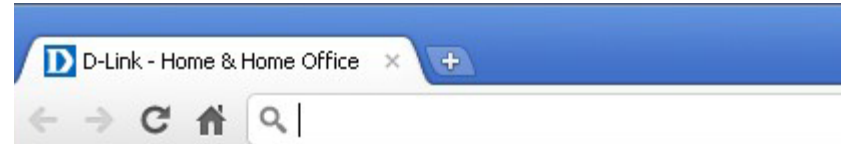

If the router does not detect a valid Ethernet connection from the Internet port, this screen will appear. Connect your broadband modem to the Internet port and then click **Connect**.

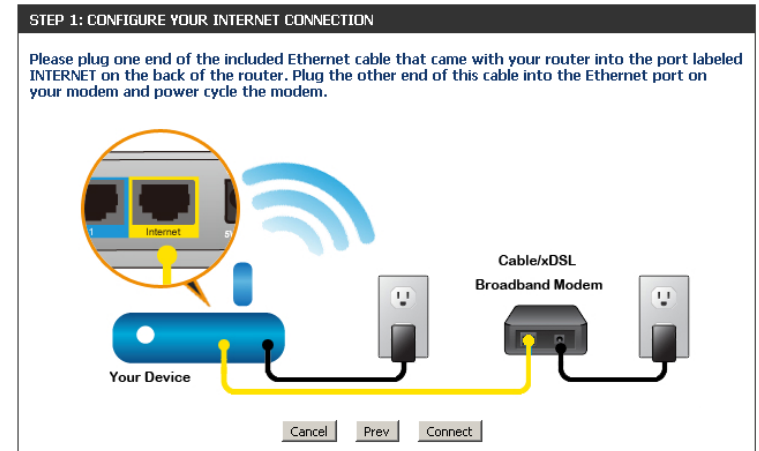

If the router detects an Ethernet connection but does not detect the type of Internet connection you have, this screen will appear. Click **Guide me through the Internet Connection Settings** to display a list of connection types to choose from.

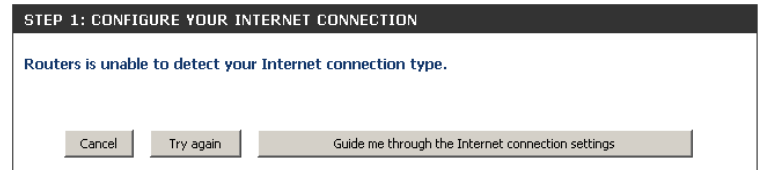

Select your Internet connection type and click **Next** to continue. You can select **DHCP Connection (Dynamic IP Address)** if your Internet connection automatically provides you with an IP Address. This option is commonly used for cable modem services. Click **Next** to continue.

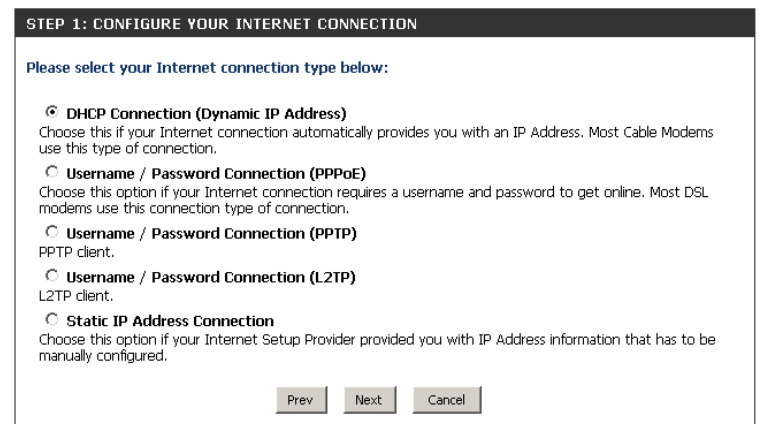

If the router detected or you selected **PPPoE**, enter your PPPoE username and password and click **Next** to continue.

**Note:** Make sure to remove your PPPoE software from your computer. The software is no longer needed and will not work through a router.

If the router detected or you selected **PPTP**, enter your PPTP username, password, and other information supplied by your ISP. Click **Next** to continue.

If the router detected or you selected **L2TP**, enter your L2TP username, password, and other information supplied by your ISP. Click **Next** to continue.

**SET USERNAME AND PASSWORD CONNECTION (PPPoE)**

To set up this connection you will need to have a Username and Password from your Internet Service Provider. If you do not have this information, please contact your ISP.

User Name :

Password :

Prev Next Cancel

**SET USERNAME AND PASSWORD CONNECTION (PPTP)**

To set up this connection you will need to have a Username and Password from your Internet Service Provider. You also need PPTP IP address. If you do not have this information, please contact your ISP.

Address Mode :  Dynamic IP  Static IP

PPTP IP Address :

PPTP Subnet Mask :

PPTP Gateway IP Address :

PPTP Server IP Address (may be same as gateway) :

User Name :

Password :

Verify Password :

**DNS SETTINGS**

Primary DNS Address :

Secondary DNS Address :

Prev Next Cancel

**SET USERNAME AND PASSWORD CONNECTION (L2TP)**

To set up this connection you will need to have a Username and Password from your Internet Service Provider. You also need L2TP IP address. If you do not have this information, please contact your ISP.

Address Mode :  Dynamic IP  Static IP

L2TP IP Address :

L2TP Subnet Mask :

L2TP Gateway IP Address :

L2TP Server IP Address (may be same as gateway) :

User Name :

Password :

Verify Password :

**DNS SETTINGS**

Primary DNS Address :

Secondary DNS Address :

Prev Next Cancel

If the router detected or you selected **Static**, enter the IP and DNS settings supplied by your ISP. Click **Next** to continue.

**SET STATIC IP ADDRESS CONNECTION**

To set up this connection you will need to have a complete list of IP information provided by your Internet Service Provider. If you have a Static IP connection and do not have this information, please contact your ISP.

IP Address :

Subnet Mask :

Gateway Address :

**DNS SETTINGS**

Primary DNS Address :

Secondary DNS Address :

For both the 2.4GHz and 5GHz segments, create a wireless network name (SSID) using up to 32 characters.

Create a wireless security passphrase or key (between 8-63 characters). Your wireless clients will need to have this passphrase or key entered to be able to connect to your wireless network.

Click **Next** to continue.

**STEP 2: CONFIGURE YOUR WI-FI SECURITY**

Give your Wi-Fi network a name and a password. (2.4GHz Band)

Wi-Fi Network Name (SSID) :  (Using up to 32 characters)

Wi-Fi Password :  (Between 8 and 63 characters)

Give your Wi-Fi network a name and a password. (5GHz Band)

Wi-Fi Network Name (SSID) :  (Using up to 32 characters)

Wi-Fi Password :  (Between 8 and 63 characters)

In order to secure your router, please enter a new password. Check the **Enable Graphical Authentication** box to enable CAPTCHA authentication for added security. Click **Next** to continue.

**STEP 3: SET YOUR PASSWORD**

By default, your new D-Link Router does not have a password configured for administrator access to the Web-based configuration pages. To secure your new networking device, please set and verify a password below, and enabling CAPTCHA Graphical Authentication provides added security protection to prevent unauthorized online users and hacker software from accessing your network settings.

Password :

Verify Password :

Enable Graphical Authentication :

Select your time zone from the drop-down menu and click **Next** to continue.

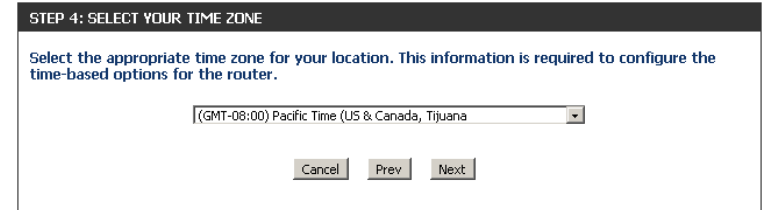

The Setup Complete window will display your wireless settings. Click **Save** to continue.

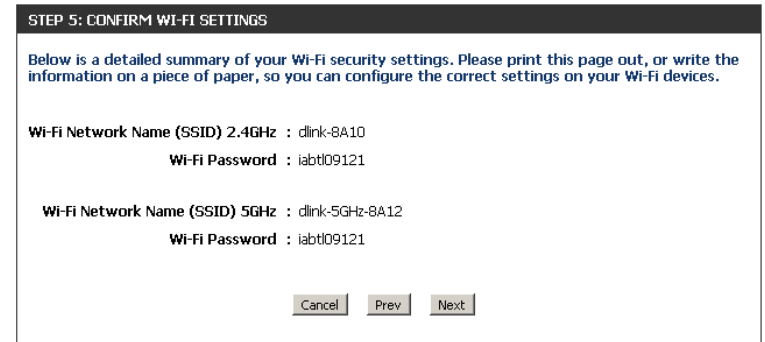

If you want to create a bookmark to the router, click **OK**. Click **Cancel** if you do not want to create a bookmark.



If you clicked **Yes**, a window may appear (depending on what web browser you are using) to create a bookmark.

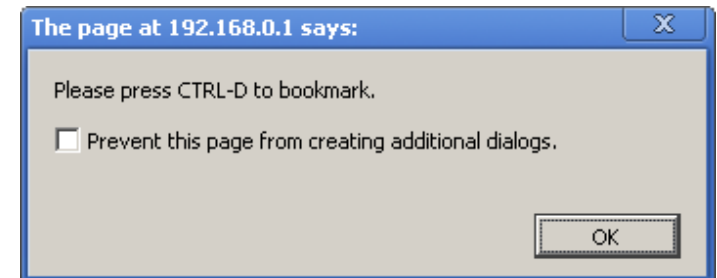

To use the mydlink service (mydlink.com or the mydlink Lite app), you must have an account. Select if you do have a mydlink account or if you need to create one. Click **Next** to continue.

If you do not want to register at this time, click **Skip**.

If you clicked **Yes, I have a mydlink account** enter your mydlink account name (E-mail address) and password. Click **Login** to register your router.

If you clicked **No, I want to login with a new mydlink account** fill out the requested information and click **Sign up** to create your mydlink account. This is a free service. Refer to [www.mydlink.com](http://www.mydlink.com) for more information.

**STEP 6: MYDLINK REGISTRATION**

This device is mydlink-enabled, which allows you to remotely monitor and manage your network through the mydlink.com website, or through the mydlink mobile app. You will be able to check your network speeds, see who is connected, view device browsing history, and receive notifications about new users or intrusion attempts.

You can register this device with your existing mydlink account. If you do not have one, you can create one now.

Do you have mydlink account?

Yes, I have a mydlink account.

No, I want to register and login with a new mydlink account.

**STEP 6: MYDLINK REGISTRATION**

E-mail Address (Account Name) :

Password :

**STEP 6: MYDLINK REGISTRATION**

Please fulfill the options to complete the registration.

E-mail Address (Account Name) :

Password :

Confirm Password :

Last name :

First Name :

[I Accept the mydlink terms and conditions.](#)



The mydlink App will allow you to receive notices, browse network users, and configure your router from an iPhone/iPad/iPod Touch (iOS 3.0 or higher), or Android device (1.6 or higher).

To download the "mydlink lite" app, visit the Apple Store, Google Play or <http://mydlink.com/Lite>.

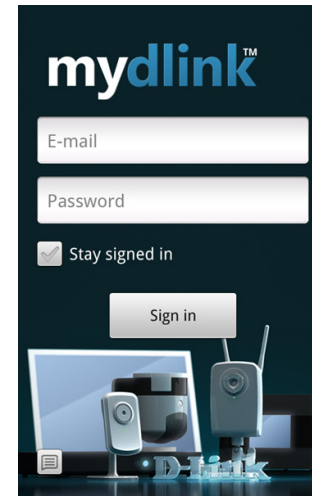

PC and Mac users can use the mydlink portal at <http://mydlink.com>.

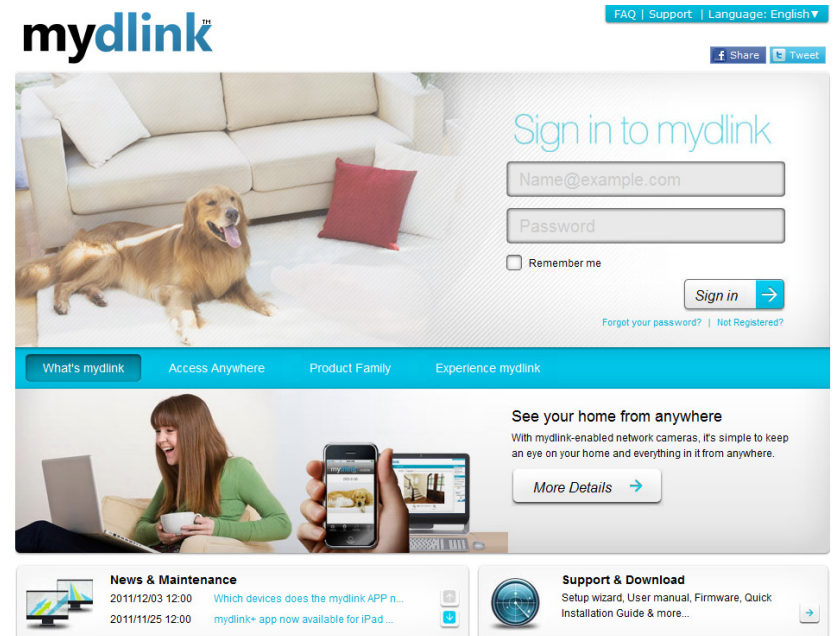

# QRS Mobile App

D-Link offers an app for your iPad, iPhone (iOS 4.3 or higher) or Android device to install and configure your router.

## Step 1

From your iPad, iPhone, or Android device, go to the iTunes Store and search for 'D-Link'. Select **QRS Mobile** and then download it.

You may also scan this code to download.



iOS



Android

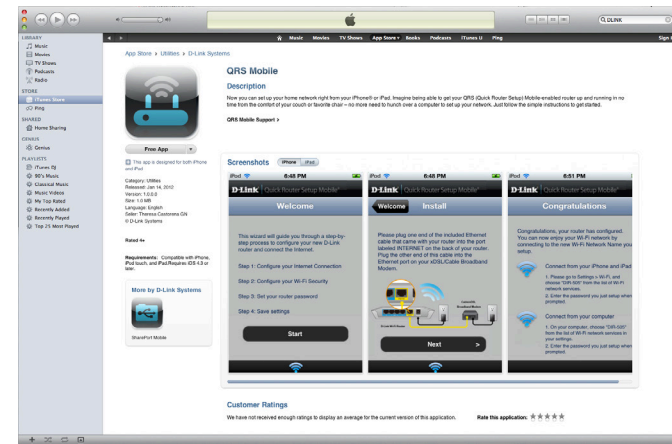

## Step 2

Once your app is installed, you may now configure your router. Connect to the router wirelessly by going to your wireless utility on your device. Scan for the wireless network name (SSID) as listed on the supplied info card. Select and then enter your security password (Wi-Fi Password).

**D-Link Wi-Fi Configuration Card**

<b>Default Configuration</b>	Wi-Fi Name(SSID) 2.4GHz:
Wi-Fi Name(SSID) 2.4GHz: dlink-2c19	Wi-Fi Password:
Wi-Fi Name(SSID) 5GHz: dlink-2c1b-media	Wi-Fi Name(SSID) 5GHz *:
Password:gccnu80856	Wi-Fi Password *:
<b>Your configuration</b>	Username: "Admin"
To configure your router, go to: http://dlinkrouter.local. Or http://192.168.0.1	Password:
Username: "Admin"	*For applicable models
Password: "" (leave the field blank)	DCW1902P1010

## Step 3

Once you connect to the router, launch the QRS mobile app and it will guide you through the installation of your router.

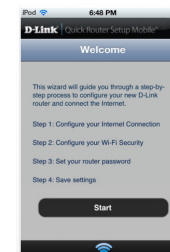

# SharePort Mobile App

The SharePort Mobile app will allow you to access files from a USB thumb drive that is plugged into your router. You must enable file sharing from the **Setup > Storage** page (refer to page 51) for this app to work properly.

1. Insert your USB flash drive into DIR-868L.

2. Scan the bar code to download the **SharePort Mobile** app from the app store to your iPhone, iPad, or Android device.



iOS



Android

3. From your iOS mobile device, click **Settings**.



Settings

4. Click **Wi-Fi**, select the wireless network (SSID) that you created in the setup and then enter your Wi-Fi password.

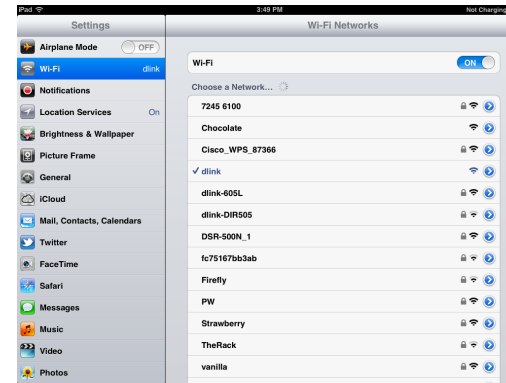

5. Once connected, click on the **SharePort Mobile** icon.



6. The following screen will appear.

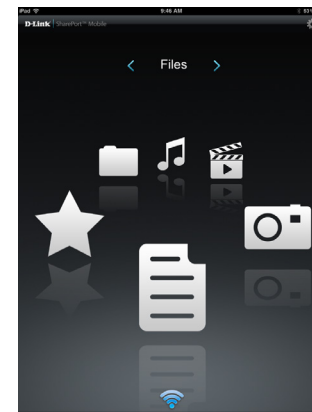

7. Click on **Settings** icon located on the right top corner of the screen. Click **Edit** to enter your User Name and Password. Once you finish, click **Done** to continue.

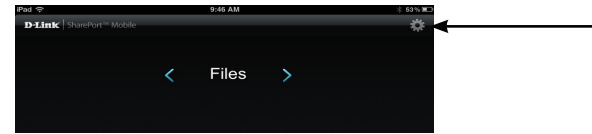

8. For the Movie section, click the movie icon to play your movie from your USB flash drive.

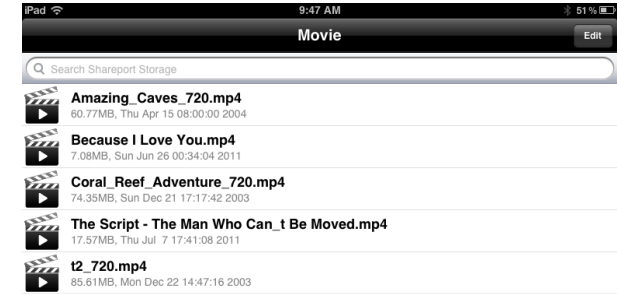

9. For the Music section, click the music icon to play your music from your USB flash drive.

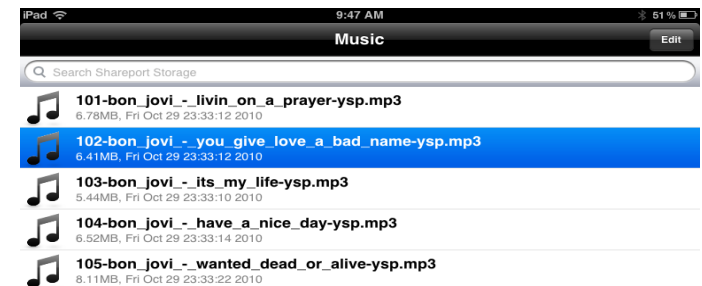

10. For the Photo section, click the photo icon to view your photos from your USB flash drive.

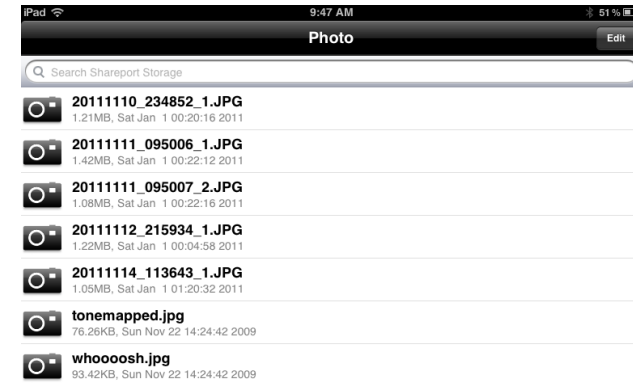

11. For the Files section, click on the files icon to view your files from your USB flash drive.

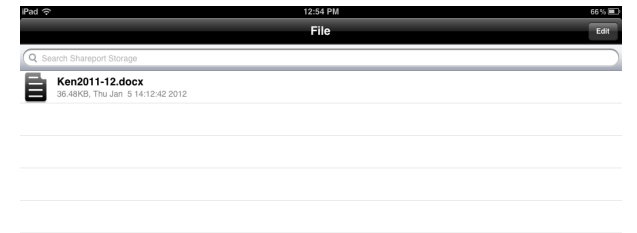

12. For the Folder section, click the folder icon to view your folders from your USB flash drive.

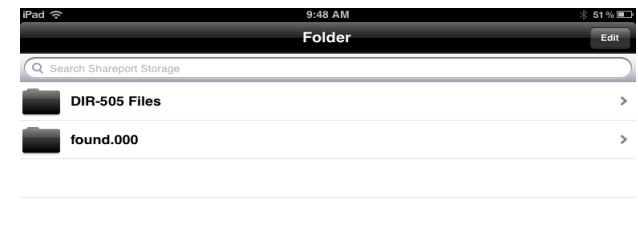

# Web-based Configuration Utility

Open a web browser (e.g., Internet Explorer, Chrome, Firefox, or Safari) and enter **http://dlinkrouter.local/** or **http://192.168.0.1**.

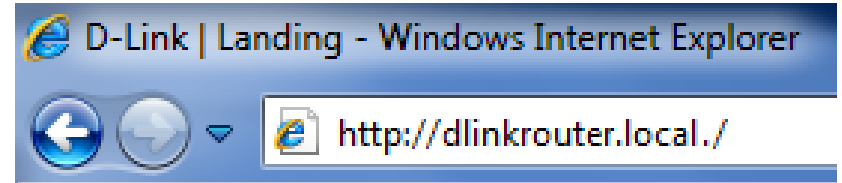

Enter your password and click **Login**.

**Note:** *If you did not create a password with the Setup Wizard, leave the password blank by default.*

A screenshot of the LOGIN page for the D-Link router configuration utility. The page has an orange header with the word "LOGIN" in white. Below the header, the text "Login to the router :" is displayed. There are two input fields: "User Name" with the value "Admin" and "Password" which is currently blank. A "Login" button is positioned to the right of the password field.

# Internet Connection Setup

Click **Manual Internet Connection Setup** to configure your connection manually and continue to the next page.

If you want to configure your router to connect to the Internet using the wizard, click **Internet Connection Setup Wizard**. You will be directed to the *Quick Setup Wizard*. Please refer to page 14.

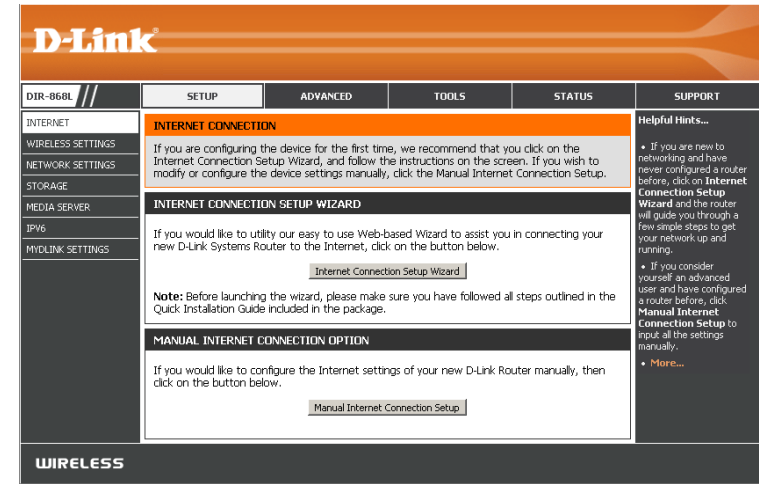

The next few pages will explain each of the ISP connection types. You can select the type from the **My Internet Connection** drop-down menu.

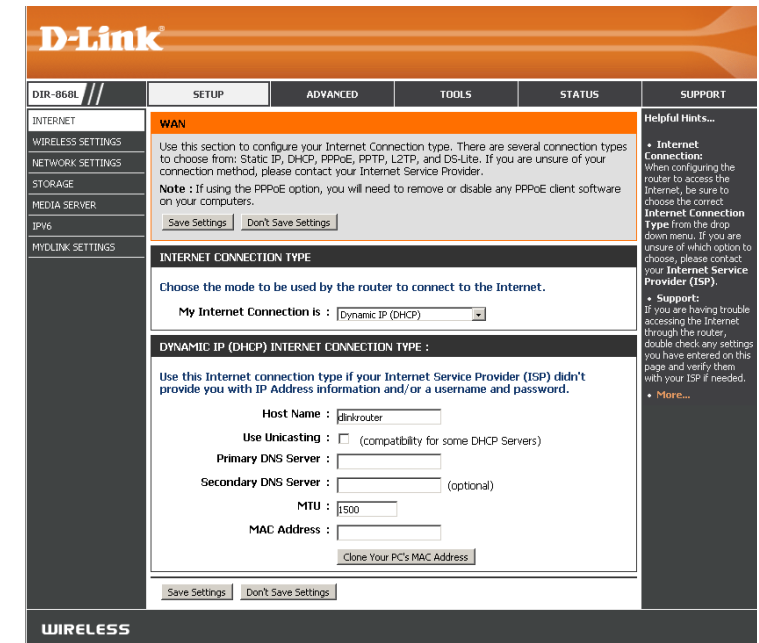



# Manual Internet Setup

## Static (assigned by ISP)

Select **Static IP** if all the Internet port's IP information is provided to you by your ISP. You will need to enter in the IP address, subnet mask, gateway address, and DNS address(es) provided to you by your ISP. Each IP address entered in the fields must be in the appropriate IP form, which are four octets separated by a dot (x.x.x.x). The Router will not accept the IP address if it is not in this format.

**My Internet Connection:** Select **Static IP** to manually enter the IP settings supplied by your ISP.

**IP Address:** Enter the IP address assigned by your ISP.

**Subnet Mask:** Enter the Subnet Mask assigned by your ISP.

**Default Gateway:** Enter the Gateway assigned by your ISP.

**DNS Servers:** The DNS server information will be supplied by your ISP (Internet Service Provider.)

**MTU:** Maximum Transmission Unit - you may need to change the MTU for optimal performance with your specific ISP. 1500 is the default MTU.

**MAC Address:** The default MAC Address is set to the Internet port's physical interface MAC address on the Broadband Router. It is not recommended that you change the default MAC address unless required by your ISP. You can use the **Clone Your PC's MAC Address** button to replace the Internet port's MAC address with the MAC address of your Ethernet card.

The screenshot shows the D-Link DIR-868L web interface. The top navigation bar includes 'DIR-868L', 'SETUP', 'ADVANCED', 'TOOLS', 'STATUS', and 'SUPPORT'. The 'WAN' section is active, displaying instructions for configuring the Internet Connection type. The 'INTERNET CONNECTION TYPE' is set to 'Static IP'. Below this, the 'STATIC IP ADDRESS INTERNET CONNECTION TYPE' section contains the following fields:

- IP Address: [ ]
- Subnet Mask: 0.0.0.0
- Default Gateway: [ ]
- Primary DNS Server: [ ]
- Secondary DNS Server: [ ] (optional)
- MTU: 1500
- MAC Address: [ ]

A 'Clone Your PC's MAC Address' button is located below the MAC Address field. The page also includes 'Save Settings' and 'Don't Save Settings' buttons. On the right side, there is a 'Helpful Hints...' section with a 'Support' link.

# Internet Setup

## Dynamic (Cable)

**My Internet Connection:** Select **Dynamic IP (DHCP)** to obtain IP Address information automatically from your ISP. Select this option if your ISP does not give you any IP numbers to use. This option is commonly used for cable modem services.

**Host Name:** The Host Name is optional but may be required by some ISPs. Leave blank if you are not sure.

**Use Unicasting:** Check the box if you are having problems obtaining an IP address from your ISP.

**Primary/Secondary DNS Server:** Enter the Primary and secondary DNS server IP addresses assigned by your ISP. These addresses are usually obtained automatically from your ISP. Leave blank if you did not specifically receive these from your ISP.

**MTU:** Maximum Transmission Unit - you may need to change the MTU for optimal performance with your specific ISP. 1500 is the default MTU.

**MAC Address:** The default MAC Address is set to the Internet port's physical interface MAC address on the Broadband Router. It is not recommended that you change the default MAC address unless required by your ISP. You can use the **Clone Your PC's MAC Address** button to replace the Internet port's MAC address with the MAC address of your Ethernet card.

The screenshot shows the D-Link DIR-868L web interface. The top navigation bar includes 'DIR-868L', 'SETUP', 'ADVANCED', 'TOOLS', 'STATUS', and 'SUPPORT'. The left sidebar lists various settings categories: INTERNET, WIRELESS SETTINGS, NETWORK SETTINGS, STORAGE, MEDIA SERVER, IPV6, and MYDLINK SETTINGS. The main content area is titled 'WAN' and contains the following information:

- WAN:** Use this section to configure your Internet Connection type. There are several connection types to choose from: Static IP, DHCP, PPPoE, PPTP, L2TP, and DS-Lite. If you are unsure of your connection method, please contact your Internet Service Provider.
  - Note:** If using the PPPoE option, you will need to remove or disable any PPPoE client software on your computers.
  - Buttons: Save Settings, Don't Save Settings
- INTERNET CONNECTION TYPE:** Choose the mode to be used by the router to connect to the Internet.
  - My Internet Connection is: Dynamic IP (DHCP)
- DYNAMIC IP (DHCP) INTERNET CONNECTION TYPE:** Use this Internet connection type if your Internet Service Provider (ISP) didn't provide you with IP Address information and/or a username and password.
  - Host Name:
  - Use Unicasting:  (compatibility for some DHCP Servers)
  - Primary DNS Server:
  - Secondary DNS Server:  (optional)
  - MTU:
  - MAC Address:
  - Clone Your PC's MAC Address
  - Buttons: Save Settings, Don't Save Settings

The right sidebar contains 'Helpful Hints...' and 'Support' information, including instructions on how to choose the correct Internet Connection Type and how to contact support if needed.

# Internet Setup

## PPPoE (DSL)

Choose PPPoE (Point to Point Protocol over Ethernet) if your ISP uses a PPPoE connection. Your ISP will provide you with a username and password. This option is typically used for DSL services. Make sure to remove your PPPoE software from your computer. The software is no longer needed and will not work through a router.

**My Internet Connection is:** Select **PPPoE (Username/Password)** from the drop-down menu.

**Address Mode:** Select **Static IP** if your ISP assigned you the IP address, subnet mask, gateway, and DNS server addresses. In most cases, select **Dynamic IP**.

**IP Address:** Enter the IP address (Static PPPoE only).

**Username:** Enter your PPPoE user name.

**Password:** Enter your PPPoE password and then retype the password in the next box.

**Service Name:** Enter the ISP Service Name (optional).

**Reconnect Mode:** Select either **Always-on**, **On-Demand**, or **Manual**.

**Maximum Idle Time:** Enter a maximum idle time during which the Internet connection is maintained during inactivity. To disable this feature, enable Auto-reconnect.

**DNS Mode/Addresses:** Select **Receive DNS from ISP** to automatically use your ISP's DNS servers or select **Enter DNS Manually** and enter the Primary and Secondary DNS Server Addresses of your choice.

**MTU:** Maximum Transmission Unit - you may need to change the MTU for optimal performance with your specific ISP. 1492 is the default MTU.

**MAC Address:** The default MAC Address is set to the Internet port's physical interface MAC address on the Broadband Router. It is not recommended that you change the default MAC address unless required by your ISP. You can use the **Clone Your PC's MAC Address** button to replace the Internet port's MAC address with the MAC address of your Ethernet card.

The screenshot shows the D-Link web interface for the DIR-868L router. The 'WAN' tab is selected, and the 'INTERNET CONNECTION TYPE' section is active. The 'My Internet Connection is' dropdown is set to 'PPPoE (Username / Password)'. The 'PPPoE INTERNET CONNECTION TYPE' section contains the following fields and options:

- Address Mode:** Radio buttons for Dynamic IP (selected) and Static IP.
- IP Address:** Text input field.
- Username:** Text input field.
- Password:** Text input field.
- Verify Password:** Text input field.
- Service Name:** Text input field (optional).
- Reconnect Mode:** Radio buttons for Always-on (selected), On demand, and Manual.
- Maximum Idle Time:** Text input field (minutes, 0=Infinite).
- DNS Mode:** Radio buttons for Receive DNS from ISP (selected) and Enter DNS Manually.
- Primary DNS Server:** Text input field.
- Secondary DNS Server:** Text input field (optional).
- MTU:** Text input field (1492).
- MAC Address:** Text input field with a 'Clone Your PC's MAC Address' button.

At the bottom of the form are 'Save Settings' and 'Don't Save Settings' buttons. A sidebar on the right contains 'Helpful Hints...' and 'Support' information.

# Internet Setup

## PPTP

Choose PPTP (Point-to-Point-Tunneling Protocol) if your ISP uses a PPTP connection. Your ISP will provide you with a username and password. This option is typically used for DSL services.

**My Internet Connection is:** Select **PPTP (Username/Password)** from the drop-down menu.

**Address Mode:** Select **Static IP** if your ISP assigned you the IP address, subnet mask, gateway, and DNS server addresses. In most cases, select **Dynamic IP**.

**PPTP IP Address:** Enter the IP address (Static PPTP only).

**PPTP Subnet Mask:** Enter the Primary and Secondary DNS Server Addresses (Static PPTP only).

**PPTP Gateway IP Address:** Enter the Gateway IP Address provided by your ISP.

**PPTP Server IP Address:** Enter the Server IP provided by your ISP (optional).

**Username:** Enter your PPTP username.

**Password:** Enter your PPTP password and then retype the password in the next box.

**Reconnect Mode:** Select either **Always-on**, **On-Demand**, or **Manual**.

**Maximum Idle Time:** Enter a maximum idle time during which the Internet connection is maintained during inactivity. To disable this feature, enable Auto-reconnect.

**DNS Servers:** The DNS server information will be supplied by your ISP (Internet Service Provider.)

The screenshot shows the D-Link router's configuration interface for PPTP. The 'WAN' tab is selected, and the 'INTERNET CONNECTION TYPE' is set to 'PPTP (Username / Password)'. The 'ADDRESS MODE' is set to 'Dynamic IP'. The 'PPTP INTERNET CONNECTION TYPE' section contains the following fields:

- PPTP IP Address:** [Empty text box]
- PPTP Subnet Mask:** [Empty text box]
- PPTP Gateway IP Address:** [Empty text box]
- PPTP Server IP Address:** [Empty text box]
- Username:** [Empty text box]
- Password:** [Empty text box]
- Verify Password:** [Empty text box]
- Reconnect Mode:** Radio buttons for 'Always-on' (selected), 'On demand', and 'Manual'.
- Maximum Idle Time:** [5] (minutes, 0=infinite)
- Primary DNS Server:** [Empty text box]
- Secondary DNS Server:** [Empty text box] (optional)
- MTU:** [1400]
- MAC Address:** [Empty text box]

Buttons for 'Save Settings' and 'Don't Save Settings' are visible at the bottom of the configuration area.

**MTU:** Maximum Transmission Unit - you may need to change the MTU for optimal performance with your specific ISP. 1400 is the default MTU.

**MAC Address:** The default MAC Address is set to the Internet port's physical interface MAC address on the Broadband Router. It is not recommended that you change the default MAC address unless required by your ISP. You can use the **Clone Your PC's MAC Address** button to replace the Internet port's MAC address with the MAC address of your Ethernet card.

# Internet Setup

## L2TP

Choose L2TP (Layer 2 Tunneling Protocol) if your ISP uses a L2TP connection. Your ISP will provide you with a username and password. This option is typically used for DSL services.

**My Internet Connection is:** Select **L2TP (Username/Password)** from the drop-down menu.

**Address Mode:** Select **Static** if your ISP assigned you the IP address, subnet mask, gateway, and DNS server addresses. In most cases, select **Dynamic IP**.

**L2TP IP Address:** Enter the L2TP IP address supplied by your ISP (Static only).

**L2TP Subnet Mask:** Enter the Subnet Mask supplied by your ISP (Static only).

**L2TP Gateway IP Address:** Enter the Gateway IP Address provided by your ISP.

**L2TP Server IP Address:** Enter the Server IP provided by your ISP (optional).

**Username:** Enter your L2TP username.

**Password:** Enter your L2TP password and then retype the password in the next box.

**Reconnect Mode:** Select either **Always-on**, **On-Demand**, or **Manual**.

**Maximum Idle Time:** Enter a maximum idle time during which the Internet connection is maintained during inactivity. To disable this feature, enable Auto-reconnect.

The screenshot shows the D-Link web interface for the DIR-868L router. The 'WAN' section is active, and the 'INTERNET CONNECTION TYPE' is set to 'L2TP (Username / Password)'. The configuration fields are as follows:

- Address Mode:**  Dynamic IP  Static IP
- L2TP IP Address:** [Text Input]
- L2TP Subnet Mask:** [Text Input]
- L2TP Gateway IP Address:** [Text Input]
- L2TP Server IP Address:** [Text Input]
- Username:** [Text Input]
- Password:** [Text Input]
- Verify Password:** [Text Input]
- Reconnect Mode:**  Always-on  On demand  Manual
- Maximum Idle Time:** 5 (minutes, 0=infinite)
- Primary DNS Server:** [Text Input]
- Secondary DNS Server:** [Text Input] (optional)
- MTU:** 1400
- MAC Address:** [Text Input]

Buttons for 'Save Settings' and 'Don't Save Settings' are visible at the bottom of the configuration area.

**DNS Servers:** Enter the Primary and Secondary DNS Server Addresses (Static L2TP only).

**MTU:** Maximum Transmission Unit - you may need to change the MTU for optimal performance with your specific ISP. 1400 is the default MTU.

**MAC Address:** The default MAC Address is set to the Internet port's physical interface MAC address on the Broadband Router. It is not recommended that you change the default MAC address unless required by your ISP. You can use the **Clone Your PC's MAC Address** button to replace the Internet port's MAC address with the MAC address of your Ethernet card.

# Internet Setup

## DS-Lite

DS-Lite is an IPv6 connection type. After selecting DS-Lite, the following parameters will be available for configuration:

**My Internet Connection is:** Select **DS-Lite** from the drop-down menu.

**DS-Lite Configuration:** Select the **DS-Lite DHCPv6 Option** to let the router allocate the AFTR IPv6 address automatically. Select the **Manual Configuration** option to enter the AFTR IPv6 address in manually.

**AFTR IPv6 Address:** After selecting the **Manual Configuration** option above, enter the AFTR IPv6 address used here.

**B4 IPv4 Address:** Enter the B4 IPv4 address value used here. (Optional.)

**WAN IPv6 Address:** Once connected, the WAN IPv6 address will be displayed here.

**IPv6 WAN Default Gateway** Once connected, the IPv6 WAN Default Gateway address will be displayed here.

The screenshot shows the D-Link DIR-868L web interface. The top navigation bar includes 'D-Link', 'DIR-868L //', and tabs for 'SETUP', 'ADVANCED', 'TOOLS', 'STATUS', and 'SUPPORT'. The left sidebar lists various settings categories: INTERNET, WIRELESS SETTINGS, NETWORK SETTINGS, STORAGE, MEDIA SERVER, IPV6, and MYDLINK SETTINGS. The main content area is titled 'WAN' and contains the following configuration options:

- INTERNET CONNECTION TYPE:** Choose the mode to be used by the router to connect to the Internet. My Internet Connection is:  (dropdown menu).
- AFTR ADDRESS INTERNET CONNECTION TYPE:** Enter the AFTR address information provided by your Internet Service Provider (ISP).
  - DS-Lite Configuration:  DS-Lite DHCPv6 Option  Manual Configuration
  - AFTR IPv6 Address:
  - B4 IPv4 Address: 192.0.0.  (optional)
  - WAN IPv6 Address:
  - IPv6 WAN Default Gateway:

Buttons for 'Save Settings' and 'Don't Save Settings' are located at the bottom of the configuration section. A 'Helpful Hints...' sidebar on the right provides additional information and support links.



# Internet Connection Setup Wizard

If you did not initially choose to install your router with the *Quick Setup Wizard*, you can click on **Internet Connection Setup Wizard** from the **Setup > Internet** screen.

This wizard is designed to guide you through a step-by-step process to configure your new D-Link router and connect to the Internet.

Click **Next** to continue.

## INTERNET CONNECTION

If you are configuring the device for the first time, we recommend that you click on the Internet Connection Setup Wizard, and follow the instructions on the screen. If you wish to modify or configure the device settings manually, click the Manual Internet Connection Setup.

## INTERNET CONNECTION SETUP WIZARD

If you would like to utilize our easy to use Web-based Wizard to assist you in connecting your new D-Link Systems Router to the Internet, click on the button below.

[Internet Connection Setup Wizard](#)

**Note:** Before launching the wizard, please make sure you have followed all steps outlined in the Quick Installation Guide included in the package.

## MANUAL INTERNET CONNECTION OPTION

If you would like to configure the Internet settings of your new D-Link Router manually, then click on the button below.

[Manual Internet Connection Setup](#)

## WELCOME TO THE D-LINK INTERNET CONNECTION SETUP WIZARD

This wizard will guide you through a step-by-step process to configure your new D-Link router and connect to the Internet.

- Step 1: Set your Password
- Step 2: Select your Time Zone
- Step 3: Configure your Internet Connection
- Step 4: Save Settings and Connect

[Prev](#)

[Next](#)

[Cancel](#)

[Connect](#)

In order to secure your router, enter a new password. Click **Next** to continue.

Select your time zone from the drop-down menu and click **Next** to continue.

Select your Internet connection type. You can select **DHCP Connection (Dynamic IP Address)** if your Internet connection automatically provides you with an IP Address. This option is commonly used for cable modem services. Click **Next** to continue.

**STEP 1: SET YOUR PASSWORD**

By default, your new D-Link Router does not have a password configured for administrator access to the Web-based configuration pages. To secure your new networking device, please set and verify a password below:

Password :

Verify Password :

**STEP 2: SELECT YOUR TIME ZONE**

Select the appropriate time zone for your location. This information is required to configure the time-based options for the router.

Time Zone :

**STEP 3: CONFIGURE YOUR INTERNET CONNECTION**

Your Internet Connection could not be detected, please select your Internet Service Provider (ISP) from the list below. If your ISP is not listed; select the 'Not Listed or Don't Know' option to manually configure your connection.

If your Internet Service Provider was not listed or you don't know who it is, please select the Internet connection type below:

- DHCP Connection (Dynamic IP Address)**  
Choose this if your Internet connection automatically provides you with an IP Address. Most Cable Modems use this type of connection.
- Username / Password Connection (PPPoE)**  
Choose this option if your Internet connection requires a username and password to get online. Most DSL modems use this type of connection.
- Username / Password Connection (PPTP)**  
Choose this option if your Internet connection requires a username and password to get online. Most DSL modems use this type of connection.
- Username / Password Connection (L2TP)**  
Choose this option if your Internet connection requires a username and password to get online. Most DSL modems use this type of connection.
- Static IP Address Connection**  
Choose this option if your Internet Setup Provider provided you with IP Address information that has to be manually configured.

If you selected **DHCP Connection (Dynamic IP Address)** you can click on **Clone Your PC's MAC Address** to copy your computer's MAC address to your router. Click **Next** to continue.

If you selected **PPPoE**, enter your PPPoE username and password and click **Next** to continue.

**Note:** Make sure to remove your PPPoE software from your computer. The software is no longer needed and will not work through a router.

**DHCP CONNECTION (DYNAMIC IP ADDRESS)**

To set up this connection, please make sure that you are connected to the D-Link Router with the PC that was originally connected to your broadband connection. If you are, then click the Clone MAC button to copy your computer's MAC Address to the D-Link Router.

MAC Address :  (optional)

Host Name :

Note: You may also need to provide a Host Name. If you do not have or know this information, please contact your ISP.

**DNS SETTINGS**

Primary DNS Address :   
Secondary DNS Address :  (optional)

**SET USERNAME AND PASSWORD CONNECTION (PPPOE)**

To set up this connection you will need to have a Username and Password from your Internet Service Provider. If you do not have this information, please contact your ISP.

User Name :   
Password :

If you selected **PPTP**, enter your PPTP username, password, and other information supplied by your ISP. Click **Next** to continue.

**SET USERNAME AND PASSWORD CONNECTION (PPTP)**

To set up this connection you will need to have a Username and Password from your Internet Service Provider. You also need PPTP IP address. If you do not have this information, please contact your ISP.

Address Mode :  Dynamic IP  Static IP

PPTP IP Address :

PPTP Subnet Mask :

PPTP Gateway IP Address :

PPTP Server IP Address :  (may be same as gateway)

User Name :

Password :

Verify Password :

**DNS SETTINGS**

Primary DNS Address :

Secondary DNS Address :  (optional)

If you selected **L2TP**, enter your L2TP username, password, and other information supplied by your ISP. Click **Next** to continue.

**SET USERNAME AND PASSWORD CONNECTION (L2TP)**

To set up this connection you will need to have a Username and Password from your Internet Service Provider. You also need L2TP IP address. If you do not have this information, please contact your ISP.

Address Mode :  Dynamic IP  Static IP

L2TP IP Address :

L2TP Subnet Mask :

L2TP Gateway IP Address :

L2TP Server IP Address :  (may be same as gateway)

User Name :

Password :

Verify Password :

**DNS SETTINGS**

Primary DNS Address :

Secondary DNS Address :  (optional)

If you selected **Static**, enter the IP and DNS settings supplied by your ISP. Click **Next** to continue.

**SET STATIC IP ADDRESS CONNECTION**

To set up this connection you will need to have a complete list of IP information provided by your Internet Service Provider. If you have a Static IP connection and do not have this information, please contact your ISP.

IP Address :

Subnet Mask :

Default Gateway :

**DNS SETTINGS**

Primary DNS Address :

Secondary DNS Address :  (optional)

When the setup process is completed, you will see this screen. Click on **Connect** to save your settings.

**SETUP COMPLETE!**

The Internet Connection Setup Wizard has completed. Click the Connect button to save your settings.

# Wireless Settings

If you want to configure the wireless settings on your router using the wizard, click **Wireless Connection Setup Wizard** and refer to the next page.

Click **Add Wireless Device with WPS** if you want to add a wireless device using Wi-Fi Protected Setup (WPS) and refer to page 44.

If you want to manually configure the wireless settings on your router click **Manual Wireless Network Setup** and refer to page 46.

**D-Link**

DIR-868L // SETUP ADVANCED TOOLS STATUS SUPPORT

INTERNET

WIRELESS SETTINGS

NETWORK SETTINGS

STORAGE

MEDIA SERVER

IPV6

MYDLINK SETTINGS

**WIRELESS SETTINGS**

The following Web-based wizards are designed to assist you in your wireless network setup and wireless device connection.

Before launching these wizards, please make sure you have followed all steps outlined in the Quick Installation Guide included in the package.

**WIRELESS NETWORK SETUP WIZARD**

This wizard is designed to assist you in your wireless network setup. It will guide you through step-by-step instructions on how to set up your wireless network and how to make it secure.

[Wireless Connection Setup Wizard](#)

**Note:** Some changes made using this Setup Wizard may require you to change some settings on your wireless client adapters so they can still connect to the D-Link Router.

**ADD WIRELESS DEVICE WITH WPS (WI-FI PROTECTED SETUP) WIZARD**

This wizard is designed to assist you in connecting your wireless device to your wireless router. It will guide you through step-by-step instructions on how to get your wireless device connected. Click the button below to begin.

[Add Wireless Device with WPS](#)

**MANUAL WIRELESS NETWORK SETUP**

If your wireless network is already set up with Wi-Fi Protected Setup, manual configuration of the wireless network will destroy the existing wireless network. If you would like to configure the wireless settings of your new D-Link Systems Router manually, then click on the Manual Wireless Network Setup button below.

[Manual Wireless Connection Setup](#)

**Helpful Hints...**

- If you already have a wireless network setup with Wi-Fi Protected Setup, click on **Add Wireless Device with WPS** to add new device to your wireless network.
- If you are new to wireless networking and have never configured a wireless router before, click on **Wireless Connection Setup Wizard** and the router will guide you through a few simple steps to get your wireless network up and running.
- If you consider yourself an advanced user and have configured a wireless router before, click **Manual Wireless Connection Setup** to input all the settings manually.
- [More...](#)

**WIRELESS**

## Wireless Connection Setup Wizard

To run the security wizard, click on **Setup** at the top and then click **Wireless Connection Setup Wizard**.

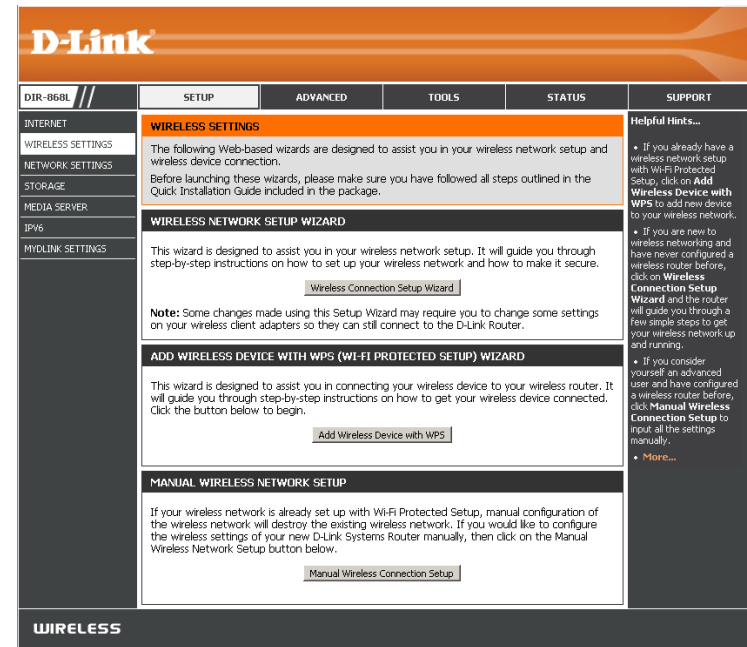

Enter a name for your wireless network (SSID), one for the 2.4GHz frequency and another for the 5GHz frequency. Do not use personal information as your SSID since users with wireless devices within range of your router will be able to see this information.

Then select one of the following options:

**Automatically:** Select this option to automatically generate the router's network key and click **Next**.

**Manually:** Select this option to manually enter your network key and click **Next**.

**STEP 1: WELCOME TO THE D-LINK WIRELESS SECURITY SETUP WIZARD**

Give your network a name, using up to 32 characters.

Network Name (SSID) 2.4GHz :

Network Name (SSID) 5Ghz :

**Automatically assign a network key (Recommended)**  
To prevent outsiders from accessing your network, the router will automatically assign a security (also called WEP or WPA key) to your network.

**Manually assign a network key**  
Use this options if you prefer to create our own key.

**Note: All D-Link wireless adapters currently support WPA.**

If you selected **Automatically**, the summary window will display your settings. Write down the security key and enter this on your wireless clients. Click **Save** to save your settings.

**SETUP COMPLETE!**

Below is a detailed summary of your wireless security settings. Please print this page out, or write the information on a piece of paper, so you can configure the correct settings on your wireless client adapters.

<p><b>Wireless Band</b> : 2.4GHz Band</p> <p><b>Wireless Network Name (SSID)</b> : dlink-8A10</p> <p><b>Security Mode</b> : Auto (WPA or WPA2) - Personal</p> <p><b>Cipher Type</b> : TKIP and AES</p> <p><b>Pre-Shared Key</b> : 8469db8bac</p>
<p><b>Wireless Band</b> : 5GHz Band</p> <p><b>Wireless Network Name (SSID)</b> : dlink-5GHz-8A12</p> <p><b>Security Mode</b> : Auto (WPA or WPA2) - Personal</p> <p><b>Cipher Type</b> : TKIP and AES</p> <p><b>Pre-Shared Key</b> : 8469db8bac</p>

Prev Next Cancel Save

If you selected **Manually**, the following screen will appear.

Create a passphrase for your security password. Click **Next** to continue.

**Note:** The security password/passphrase must be between 8 and 63 characters and is case-sensitive. You will need to enter this passphrase on your wireless clients exactly or it will not connect.

**STEP 2: SET YOUR WIRELESS SECURITY PASSWORD**

You have selected your security level - you will need to set a wireless security password.

The WPA (Wi-Fi Protected Access) key must meet one of following guidelines:

- Between 8 and 63 characters (A longer WPA key is more secure than a short one )
- Exactly 64 characters using 0-9 and A-F

Use the same Wireless Security Password on both 2.4GHz and 5GHz band

**Wireless Security Password** :

**Note:** You will need to enter the same password as keys in this step into your wireless clients in order to enable proper wireless communication.

Prev Next Cancel Save



## Add Wireless Device with WPS Wizard

From the **Setup > Wireless Settings** screen, click **Add Wireless Device with WPS**.

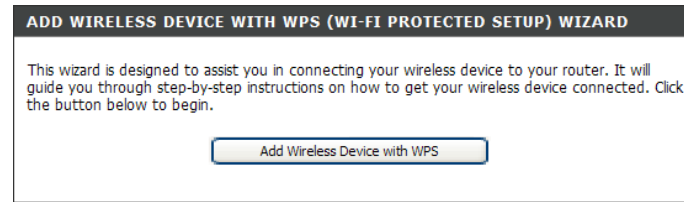

Select **Auto** to add a wireless client using WPS (Wi-Fi Protected Setup) and then click **Next**. Skip to the next page.

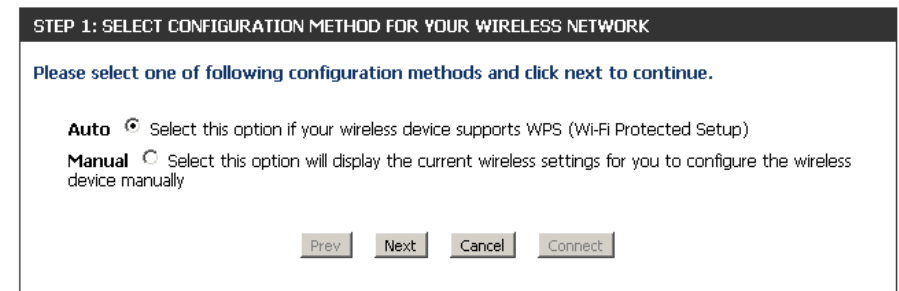

If you select **Manual**, a settings summary screen will appear. Write down the security key and enter this on your wireless clients. Click **Wireless Status** to finish. This will take you to the *Wireless Status* screen.

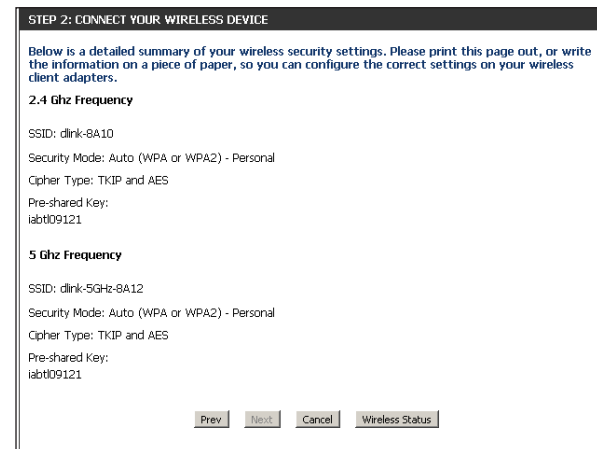

**PIN:** Select this option to use PIN method. In order to use this method you must know the wireless client's 8 digit PIN and click **Connect**.

**PBC:** Select this option to use PBC (Push Button) method to add a wireless client. Click **Connect**.

Once you click **Connect**, you will have a 120 second time limit to apply the settings to your wireless client(s) and successfully establish a connection.

Click **Wireless Status** to finish. This will take you to *Wireless Status* screen.

**STEP 2: CONNECT YOUR WIRELESS DEVICE**

There are two ways to add wireless device to your wireless network:  
-PIN (Personal Identification Number)  
-PBC (Push Button Configuration)

**PIN** :

please enter the PIN from your wireless device and click the below "Connect" Button within 120 seconds

**PBC**

please press the push button on your wireless device and click the below "Connect" Button within 120 seconds

**STEP 2: CONNECT YOUR WIRELESS DEVICE**

Please press down the Push Button (physical or virtual) on the wireless device you are adding to your wireless network.  
Remain time in second: 118

Adding wireless device: Started.

**STEP 2: CONNECT YOUR WIRELESS DEVICE**

Adding wireless device: Succeeded. To add another device click on the Cancel button below or click on the Wireless Status button to check wireless status.

# Manual Wireless Settings

## 802.11n/g (2.4GHz)

**Enable Wireless:** Check the box to enable the wireless function. If you do not want to use wireless, uncheck the box to disable all the wireless functions.

**Schedule:** Select the time frame that you would like your wireless network enabled. The schedule may be set to **Always**. Any schedule you create will be available in the drop-down menu. Click **New Schedule** to create a schedule.

**Wireless Network Name:** Service Set Identifier (SSID) is the name of your wireless network. Create a name for your wireless network using up to 32 characters. The SSID is case-sensitive.

**802.11 Mode:** Select one of the following:

- 802.11b Only** - Select only if all of your wireless clients are 802.11b.
- 802.11g Only** - Select only if all of your wireless clients are 802.11g.
- 802.11n Only** - Select only if all of your wireless clients are 802.11n.
- Mixed 802.11g and 802.11b** - Select if you are using both 802.11g and 802.11b wireless clients.
- Mixed 802.11n and 802.11g** - Select if you are using both 802.11n and 802.11g wireless clients.
- Mixed 802.11n, 11g, and 11b** - Select if you are using a mix of 802.11n, 802.11g, and 802.11b wireless clients.

**Enable Auto Channel Scan:** The **Auto Channel Scan** setting can be selected to allow the DIR-868L to choose the channel with the least amount of interference.

**Wireless Channel:** Indicates the channel setting for the DIR-868L. By default the channel is set to 6. The Channel can be changed to fit the channel setting for an existing wireless network or to customize the wireless network. If you enable **Auto Channel Scan**, this option will be greyed out.

**Channel Width:** Select the Channel Width:

- Auto 20/40** - This is the default setting. Select if you are using both 802.11n and non-802.11n wireless devices.
- 20MHz** - Select if you are not using any 802.11n wireless clients.

**Visibility Status:** Select **Invisible** if you do not want the SSID of your wireless network to be broadcasted by the DIR-868L. If Invisible is selected, the SSID of the DIR-868L will not be seen by Site Survey utilities so your wireless clients will have to know the SSID of your DIR-868L in order to connect to it.

**Wireless Security:** Refer to page 48 for more information regarding wireless security.

WIRELESS NETWORK SETTINGS

**Wireless Band :** 2.4GHz Band

**Enable Wireless :**  Always New Schedule

**Wireless Network Name :**  (Also called the SSID)

**802.11 Mode :**

**Enable Auto Channel Scan :**

**Wireless Channel :**

**Transmission Rate :**  (Mbit/s)

**Channel Width :**

**Visibility Status :**  Visible  Invisible

WIRELESS SECURITY MODE

**Security Mode :**

## 802.11ac/n/a (5GHz)

**Enable Wireless:** Check the box to enable the wireless function. If you do not want to use wireless, uncheck the box to disable all the wireless functions.

**Schedule:** Select the time frame that you would like your wireless network enabled. The schedule may be set to **Always**. Any schedule you create will be available in the drop-down menu. Click **New Schedule** to create a schedule.

**Wireless Network Name:** Service Set Identifier (SSID) is the name of your wireless network. Create a name for your wireless network using up to 32 characters. The SSID is case-sensitive.

**802.11 Mode:** Select one of the following:  
**802.11n Only** - Select only if all of your wireless clients are 802.11n.  
**802.11ac Only** - Select only if all of your wireless clients are 802.11ac.  
**Mixed 802.11a and 802.11n** - Select if you are using both 802.11a and 802.11n wireless clients.  
**Mixed 802.11ac and 802.11n** - Select if you are using both 802.11ac and 802.11n wireless clients.  
**Mixed 802.11ac, 11n and 11a** - Select if you are using a mix of 802.11ac, 802.11n, and 802.11a wireless clients.

**Enable Auto Channel Scan:** The **Auto Channel Scan** setting can be selected to allow the DIR-868L to choose the channel with the least amount of interference.

**Wireless Channel:** Indicates the channel setting for the DIR-868L. By default the channel is set to 6. The Channel can be changed to fit the channel setting for an existing wireless network or to customize the wireless network. If you enable **Auto Channel Scan**, this option will be greyed out.

**Channel Width:** Select the Channel Width:  
**20MHz** - Select if you are not using any 802.11n wireless clients.  
**20/40MHz (Auto)** - This is the default setting. Select if you are using both 802.11n and non-802.11n wireless devices.  
**20/40/80MHz (Auto)** - Select if you are using 802.11ac, 802.11n and non-802.11n wireless devices. This option is only available when the 802.11 Mode is set to Mixed 802.11ac.

**Visibility Status:** Select **Invisible** if you do not want the SSID of your wireless network to be broadcasted by the DIR-868L. If Invisible is selected, the SSID of the DIR-868L will not be seen by Site Survey utilities so your wireless clients will have to know the SSID of your DIR-868L in order to connect to it.

**Wireless Security:** Refer to page 48 for more information regarding wireless security.

**WIRELESS NETWORK SETTINGS**

**Wireless Band :** 5GHz Band

**Enable Wireless :**  Always New Schedule

**Wireless Network Name :**  (Also called the SSID)

**802.11 Mode :** Mixed 802.11ac, 802.11n and 802.11a

**Enable Auto Channel Scan :**

**Wireless Channel :** 5.180 GHz - CH 36

**Transmission Rate :** Best (automatic) (Mbit/s)

**Channel Width :** 20/40/80 MHz(Auto)

**Visibility Status :**  Visible  Invisible

**WIRELESS SECURITY MODE**

**Security Mode :** WPA-Personal

# Wireless Security

This section will show you the different levels of security you can use to protect your data from intruders. The DIR-868L offers the following types of security:

- WPA2 (Wi-Fi Protected Access 2)
- WPA (Wi-Fi Protected Access)
- WPA2-PSK (Pre-Shared Key)
- WPA-PSK (Pre-Shared Key)

## What is WPA?

WPA (Wi-Fi Protected Access), is a Wi-Fi standard that was designed to improve the security features of WEP (Wired Equivalent Privacy).

The 2 major improvements over WEP:

- Improved data encryption through the Temporal Key Integrity Protocol (TKIP). TKIP scrambles the keys using a hashing algorithm and, by adding an integrity-checking feature, ensures that the keys haven't been tampered with. WPA2 is based on 802.11i and uses Advanced Encryption Standard (AES) instead of TKIP.
- User authentication, which is generally missing in WEP, through the extensible authentication protocol (EAP). WEP regulates access to a wireless network based on a computer's hardware-specific MAC address, which is relatively simple to be sniffed out and stolen. EAP is built on a more secure public-key encryption system to ensure that only authorized network users can access the network.

WPA-PSK/WPA2-PSK uses a passphrase or key to authenticate your wireless connection. The key is an alpha-numeric password between 8 and 63 characters long. The password can include symbols (!?\*&\_) and spaces. This key must be the exact same key entered on your wireless router or access point.

WPA/WPA2 incorporates user authentication through the Extensible Authentication Protocol (EAP). EAP is built on a more secure public key encryption system to ensure that only authorized network users can access the network.

## WPA/WPA2-Personal (PSK)

It is recommended to enable wireless security on your wireless router before your wireless network adapters. Please establish wireless connectivity before enabling encryption.

1. Log into the web-based configuration by opening a web browser and entering the IP address of the router (192.168.0.1). Click on **Setup** and then click **Wireless Settings** on the left side.
2. Next to *Security Mode*, select **WPA-Personal**.
3. Next to *WPA Mode*, select **Auto, WPA2 Only, or WPA Only**. Use **Auto** if you have wireless clients using both WPA and WPA2.
4. Next to *Cypher Type*, select **TKIP and AES, TKIP, or AES**.
5. Next to *Group Key Update Interval*, enter the amount of time before the group key used for broadcast and multicast data is changed (3600 is default).
6. Next to *Pre-Shared Key*, enter a key (passphrase). The key is entered as a pass-phrase in ASCII format at both ends of the wireless connection. The pass-phrase must be between 8-63 characters.
7. Click **Save Settings** to save your settings. If you are configuring the router with a wireless adapter, you will lose connectivity until you enable WPA-PSK on your adapter and enter the same passphrase as you did on the router.

WIRELESS SECURITY MODE	
Security Mode :	<input type="text" value="WPA-Personal"/>
WPA	
<p>Use <b>WPA or WPA2</b> mode to achieve a balance of strong security and best compatibility. This mode uses WPA for legacy clients while maintaining higher security with stations that are WPA2 capable. Also the strongest cipher that the client supports will be used. For best security, use <b>WPA2 Only</b> mode. This mode uses AES(CCMP) cipher and legacy stations are not allowed access with WPA security. For maximum compatibility, use <b>WPA Only</b>. This mode uses TKIP cipher. Some gaming and legacy devices work only in this mode.</p> <p>To achieve better wireless performance use <b>WPA2 Only</b> security mode (or in other words AES cipher).</p>	
WPA Mode :	<input type="text" value="Auto(WPA or WPA2)"/>
Cipher Type :	<input type="text" value="TKIP and AES"/>
Group Key Update Interval :	<input type="text" value="3600"/> (seconds)
PRE-SHARED KEY	
<p>Enter an 8- to 63-character alphanumeric pass-phrase. For good security it should be of ample length and should not be a commonly known phrase.</p>	
Pre-Shared Key :	<input type="text" value="jabt09121"/>

## Configure WPA/WPA2-Enterprise (RADIUS)

It is recommended to enable wireless security on your wireless router before your wireless network adapters. Please establish wireless connectivity before enabling encryption.

1. Log into the web-based configuration by opening a web browser and entering the IP address of the router (192.168.0.1). Click on **Setup** and then click **Wireless Settings** on the left side.
2. Next to *Security Mode*, select **WPA-Enterprise**.
3. Next to *WPA Mode*, select **Auto, WPA2 Only, or WPA Only**. Use **Auto** if you have wireless clients using both WPA and WPA2.
4. Next to *Cypher Type*, select **TKIP and AES, TKIP, or AES**.
5. Next to *Group Key Update Interval*, enter the amount of time before the group key used for broadcast and multicast data is changed (3600 is default).
6. Next to *RADIUS Server IP Address* enter the IP Address of your RADIUS server.

**WIRELESS SECURITY MODE**

Security Mode : WPA-Enterprise

**WPA**

Use **WPA or WPA2** mode to achieve a balance of strong security and best compatibility. This mode uses WPA for legacy clients while maintaining higher security with stations that are WPA2 capable. Also the strongest cipher that the client supports will be used. For best security, use **WPA2 Only** mode. This mode uses AES(CCMP) cipher and legacy stations are not allowed access with WPA security. For maximum compatibility, use **WPA Only**. This mode uses TKIP cipher. Some gaming and legacy devices work only in this mode.

To achieve better wireless performance use **WPA2 Only** security mode (or in other words AES cipher).

WPA Mode : Auto(WPA or WPA2)

Cipher Type : TKIP and AES

Group Key Update Interval :  (seconds)

**EAP (802.1X)**

**When WPA enterprise is enabled, the router uses EAP (802.1x) to authenticate clients via a remote RADIUS server.**

RADIUS server IP Address :

RADIUS server Port :

RADIUS server Shared Secret :

Advanced >>

7. Next to *RADIUS Server Port*, enter the port you are using with your RADIUS server. 1812 is the default port.
8. Next to *RADIUS Server Shared Secret*, enter the security key.
9. If the *MAC Address Authentication* box is selected then the user will need to connect from the same computer whenever logging into the wireless network.
10. Click **Advanced** to enter settings for a secondary RADIUS Server.
11. Click **Save Settings** to save your settings.

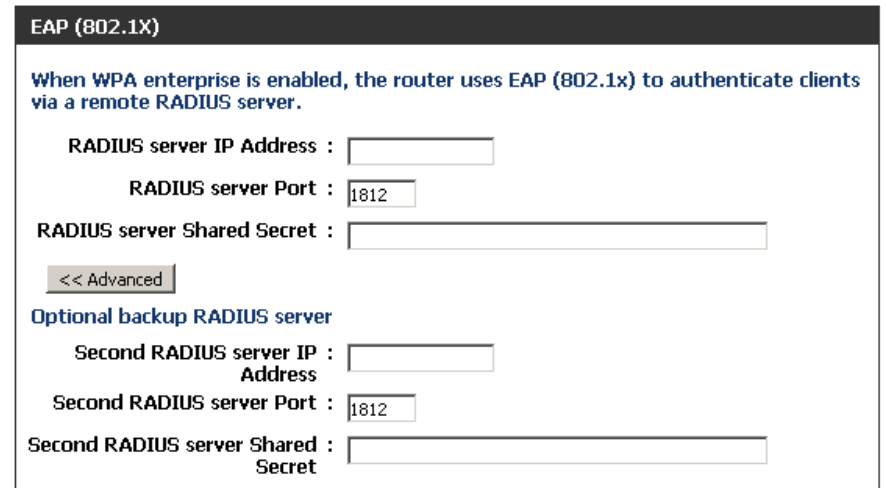

**EAP (802.1X)**

When WPA enterprise is enabled, the router uses EAP (802.1x) to authenticate clients via a remote RADIUS server.

RADIUS server IP Address :

RADIUS server Port :

RADIUS server Shared Secret :

<< Advanced

**Optional backup RADIUS server**

Second RADIUS server IP Address :

Second RADIUS server Port :

Second RADIUS server Shared Secret :



# Network Settings

This section will allow you to change the local network settings of the router and to configure the DHCP settings.

## Router Settings

**Router IP Address:** Enter the IP address of the router. The default IP address is 192.168.0.1.

If you change the IP address, once you click **Save Settings**, you will need to enter the new IP address in your browser to get back into the configuration utility.

**Default Subnet Mask:** Enter the Subnet Mask. The default subnet mask is 255.255.255.0.

**Host Name:** Enter a name for the router.

**Local Domain Name:** Enter the Domain name (Optional).

**Enable DNS Relay:** Uncheck the box to transfer the DNS server information from your ISP to your computers. If checked, your computers will use the router for a DNS server.

**D-Link**

DIR-868L // SETUP ADVANCED TOOLS STATUS SUPPORT

**NETWORK SETTINGS**

Use this section to configure the internal network settings of your router and also to configure the built-in DHCP server to assign IP addresses to computers on your network. The IP address that is configured here is the IP address that you use to access the Web-based management interface. If you change the IP address in this section, you may need to adjust your PC's network settings to access the network again.

**Please note that this section is optional and you do not need to change any of the settings here to get your network up and running.**

Save Settings Don't Save Settings

**ROUTER SETTINGS**

Use this section to configure the internal network settings of your router. The IP address that is configured here is the IP address that you use to access the Web-based management interface. If you change the IP address here, you may need to adjust your PC's network settings to access the network again.

Router IP Address : 192.168.0.1

Default Subnet Mask : 255.255.255.0

Host Name : dlinkrouter

Local Domain Name : (optional)

Enable DNS Relay :

**Helpful Hints...**

- If you already have a DHCP server on your network or are using static IP addresses on all the devices on your network, uncheck **Enable DHCP Server** to disable this feature.
- If you have devices on your network that should always have fixed IP addresses, add a **DHCP Reservation** for each such device.
- [More...](#)

## DHCP Server Settings

DHCP stands for Dynamic Host Control Protocol. The DIR-868L has a built-in DHCP server. The DHCP Server will automatically assign an IP address to the computers on the LAN/private network. Be sure to set your computers to be DHCP clients by setting their TCP/IP settings to "Obtain an IP Address Automatically." When you turn your computers on, they will automatically load the proper TCP/IP settings provided by the DIR-868L. The DHCP Server will automatically allocate an unused IP address from the IP address pool to the requesting computer. You must specify the starting and ending address of the IP address pool.

**Enable DHCP Server:** Check this box to enable the DHCP server on your router. Uncheck to disable this function.

**DHCP IP Address Range:** Enter the starting and ending IP addresses for the DHCP server's IP assignment.

**Note:** If you statically (manually) assign IP addresses to your computers or devices, make sure the IP addresses are outside of this range or you may have an IP conflict.

**DHCP Lease Time:** The length of time for the IP address lease. Enter the Lease time in minutes.

**Always Broadcast:** Enable this feature to broadcast your networks DHCP server to LAN/WLAN clients.

**NetBIOS Announcement:** NetBIOS allows LAN hosts to discover all other computers within the network, enable this feature to allow the DHCP Server to offer NetBIOS configuration settings.

**Learn NetBIOS from WAN:** Enable this feature to allow WINS information to be learned from the WAN side, disable to allow manual configuration.

**NetBIOS Scope:** This feature allows the configuration of a NetBIOS 'domain' name under which network hosts operates. This setting has no effect if the 'Learn NetBIOS information from WAN' is activated.

**DHCP SERVER SETTINGS**

Use this section to configure the built-in DHCP server to assign IP address to the computers on your network.

**Enable DHCP Server :**

**DHCP IP Address Range :**  to  (addresses within the LAN subnet)

**DHCP Lease Time :**  (minutes)

**Always broadcast :**  (compatibility for some DHCP Clients)

**NetBIOS announcement :**

**Learn NetBIOS from WAN :**

**NetBIOS Scope :**  (optional)

**NetBIOS node type :**

- Broadcast only (use when no WINS servers configured)
- Point-to-Point (no broadcast)
- Mixed-mode (Broadcast then Point-to-Point)
- Hybrid (Point-to-Point then Broadcast)

**Primary WINS IP Address :**

**Secondary WINS IP Address :**

**NetBIOS Node Type:** Select the different type of NetBIOS node; **Broadcast only, Point-to-Point, Mixed-mode,** and **Hybrid.**

**WINS IP Address:** Enter your WINS Server IP address(es).

## DHCP Reservation

If you want a computer or device to always have the same IP address assigned, you can create a DHCP reservation. The router will assign the IP address only to that computer or device.

**Note:** This IP address must be within the DHCP IP Address Range.

**Enable:** Check this box to enable the reservation.

**Computer Name:** Enter the computer name or select from the drop-down menu and click <<.

**IP Address:** Enter the IP address you want to assign to the computer or device. This IP Address must be within the DHCP IP Address Range.

**MAC Address:** Enter the MAC address of the computer or device.

**Clone Your PC's MAC Address:** You can use the **Clone Your PC's MAC Address** button to replace the Internet port's MAC Address with the MAC address of your Ethernet card.

**Save:** Click **Save** to save your entry. You must click **Save Settings** at the top to activate your reservations.

### DHCP Reservations List

**DHCP Reservations List:** Displays any reservation entries. Displays the host name (name of your computer or device), MAC Address, and IP address.

**Enable:** Check to enable the reservation.

**Edit:** Click the edit icon to make changes to the reservation entry.

**Delete:** Click the trash icon to remove the reservation from the list.

**ADD DHCP RESERVATION**

**Enable :**

**Computer Name :**  <<

**IP Address :**

**MAC Address :**

**DHCP RESERVATIONS LIST**

Enable	Host Name	MAC Address	IP Address
<input checked="" type="checkbox"/>	PM_test01	00:04:23:2c:51:a3	192.168.0.112

**NUMBER OF DYNAMIC DHCP CLIENTS : 1**

Hardware Address	Assigned IP	Hostname	Expires	
00:04:23:2c:51:a3	192.168.0.112	PM_test01	Thu Sep 1 19:49:06 2011	<a href="#">Revoke</a> <a href="#">Reserve</a>

**DHCP RESERVATIONS LIST**

Enable	Host Name	MAC Address	IP Address	
<input checked="" type="checkbox"/>	PM_test01	00:04:23:2c:51:a3	192.168.0.112	

**NUMBER OF DYNAMIC DHCP CLIENTS : 1**

Hardware Address	Assigned IP	Hostname	Expires	
00:04:23:2c:51:a3	192.168.0.112	PM_test01	Thu Sep 1 19:49:06 2011	<a href="#">Revoke</a> <a href="#">Reserve</a>

# Storage

This page will allow you to access files from a USB external hard drive or thumb drive that is plugged into the router from your local network or from the Internet using either a web browser or an app for your smartphone or tablet. You can create users to allow access to these files.

**Enable SharePort Web Access:** Check to enable sharing files on your USB storage device that is plugged in your router.

**HTTP Access Port:** Enter a port (8181 is default). You will have to enter this port in the URL when connecting to the shared files. For example: (**http://192.168.0.1:8181**).

**HTTPS Access Port:** Enter a port (4433 is default). You will have to enter this port in the URL when connecting to the shared files. For example: (**https://192.168.0.1:4433**).

**Allow Remote Access:** Check this option the allow remote access to this router.

**User Name:** To create a new user, enter a user name.

**Password:** Enter a password for this account.

**Verify Password:** Re-enter the password. Click **Add/Edit** to create the user.

**User List:** Displays the accounts. The Admin and Guest accounts are built-in to the router.

**Number of Devices:** Displays the USB device plugged into the router.

The screenshot shows the D-Link DIR-868L web interface. The top navigation bar includes 'DIR-868L', 'SETUP', 'ADVANCED', 'TOOLS', 'STATUS', and 'SUPPORT'. The 'STORAGE' section is active, displaying instructions for Web File Access and buttons for 'Save Settings' and 'Don't Save Settings'. Below this is the 'SHAREPORT WEB ACCESS' section with checkboxes for 'Enable SharePort Web Access' (checked), 'HTTP Access Port' (8181), 'HTTPS Access Port' (4433), and 'Allow Remote Access' (unchecked). The '10 -- USER CREATION' section contains fields for 'User Name', 'Password', and 'Verify Password', along with an 'Add/Edit' button. The 'USER LIST' section shows a table with one user: 'admin' with 'Read/Write' permissions. The 'NUMBER DEVICES:0' section shows a table with columns for 'Device', 'Total Space', and 'Free Space'. The 'SHAREPORT ACCESS LINK' section provides a link to connect to the drive and log in with a user account, with 'Save Settings' and 'Don't Save Settings' buttons.

## Access Files from the Internet

Below are step-by-step instructions on how to access files that are on your USB thumb drive or external hard drive that is connected to your router:

### Step 1 - Enable SharePort Web Access

Check the **Enable SharePort Web Access** checkbox to enable. Then enter the port(s) for HTTP or HTTPS (secure). The default for HTTP is 8181 and HTTPS is 4433.

### Step 2 - Create a User Account

Under *User Creation*, enter a username and password, and then click **Add/Edit**.

### Step 3 - Configure your Access Path

Under *User List*, click the **Modify** icon for the user you just created. Here you can browse to the folder on your USB storage device you want to assign the Access Path to.

### Step 4 - Save Settings

If you want to add more users, repeat steps 2 and 3. Once you are finished, click the **Save Settings** button at the top to save your settings.

Note that under the HTTP Storage Link (at the bottom) will display the URL(s) you can use to connect. Also if you selected HTTPS, you must type in **HTTPS://** instead of **HTTP://** to get a secure connection.

For example, if you selected HTTPS and changed the port to 3200, and your WAN IP address is 1.2.3.4, then you would enter **HTTPS://1.2.3.4:3200** to connect.

**10 -- USER CREATION**

**User Name :**  << User Name ▾

**Password :**

**Verify Password :**  Add/Edit Delete

**USER LIST**

📄 : Modify 🗑️ : Delete

No.	User Name	Access Path	Permission
1	admin	/	Read/Write
2	guest	None	Read Only 📄
3	d-link	(1) /Storage(B0)/	Read/Write 📄 🗑️

**NUMBER OF DEVICES : 1**

Device	Total Space	Free Space
Storage(B0)	15.04 GB	14.65 GB

# Media Server

This feature allows you to share music, pictures, and videos with any devices connected to your network. The iTunes Server allows iTunes software to automatically detect and play music from the router.

**Enable DLNA Server:** Click on this button to enable the *DLNA Server* feature.

**DLNA Server Name:** Enter the DLNA server's name.

**Folder:** Uncheck the checkbox for **root** to select a folder on your thumb drive. Click on the **Browse** button.

**Enable iTunes Server:** Click on this button to enable the *iTunes Server* feature.

**Folder:** Uncheck the checkbox for **root** to select a folder on your thumb drive. Click on the **Browse** button.

**USB 3.0:** Click **Disable** if you want to disable the USB port.

The screenshot shows the D-Link DIR-868L web interface. The top navigation bar includes 'DIR-868L //', 'SETUP', 'ADVANCED', 'TOOLS', 'STATUS', and 'SUPPORT'. The left sidebar lists various settings categories: INTERNET, WIRELESS SETTINGS, NETWORK SETTINGS, STORAGE, MEDIA SERVER, IPV6, and MYDLINK SETTINGS. The main content area is titled 'MEDIA SERVER' and contains the following information:

**MEDIA SERVER**  
 DLNA (Digital Living Network Alliance) is the standard for the interoperability of Network Media Devices (NMDs). The user can enjoy multi-media applications (music, pictures and videos) on your network connected PC or media devices. The iTunes server will allow iTunes software to automatically detect and play music from the router.

**NOTE:** The shared media may not be secure. Allowing any devices to stream is recommended only on secure networks.

Buttons: Save Settings, Don't Save Settings

---

**DLNA SERVER**

DLNA Server :  Enable  Disable  
 DLNA Server Name :   
 Folder :  root

---

**ITUNES SERVER**

iTunes Server :  Enable  Disable  
 Folder :  root

---

**USB 3.0**

USB 3.0 :  Enable  Disable

Buttons: Save Settings, Don't Save Settings

The bottom of the page shows the 'WIRELESS' section.

# IPv6

On this page, the user can configure the IPv6 Connection type. There are three ways to set up the IPv6 Internet connection.

For the beginner user that has not configured a router before, click on the **IPv6 Internet Connection Setup Wizard** button and the router will guide you through a few simple steps to get your network up and running. (Refer to page 61.)

For the advanced user that has configured a router before, click on the **Manual IPv6 Internet Connection Setup** button to input all the settings manually. (Refer to page 66.)

If you would like to manually configure the IPv6 local connectivity settings of your router, click on **IPv6 Local Connectivity Settings**.

The screenshot displays the D-Link DIR-868L web interface. The top navigation bar includes tabs for SETUP, ADVANCED, TOOLS, STATUS, and SUPPORT. The left sidebar lists various settings categories: INTERNET, WIRELESS SETTINGS, NETWORK SETTINGS, STORAGE, MEDIA SERVER, IPv6, and MYDLINK SETTINGS. The main content area is titled 'IPv6 INTERNET CONNECTION' and provides instructions on how to set up an IPv6 Internet connection. It offers three options: using the 'IPv6 Internet Connection Setup Wizard' (recommended for beginners), or manually configuring the connection. A note advises users to follow the Quick Installation Guide before launching the wizards. Below this, there are sections for 'MANUAL IPv6 LOCAL CONNECTIVITY SETUP' and 'MANUAL IPv6 INTERNET CONNECTION SETUP', each with a corresponding button to access the configuration page. A 'Helpful Hints...' sidebar on the right provides additional guidance for new and advanced users.

DIR-868L //	SETUP	ADVANCED	TOOLS	STATUS	SUPPORT
INTERNET	<b>IPv6 INTERNET CONNECTION</b>				<b>Helpful Hints...</b> <ul style="list-style-type: none"> <li>If you are new to networking and have never configured a router before, click on <b>IPv6 Internet Connection Setup Wizard</b> and the router will guide you through a few simple steps to get your network up and running.</li> <li>If you consider yourself an advanced user and have configured a router before, click <b>Manual IPv6 Internet Connection Setup</b> to input all the settings manually.</li> <li><a href="#">More...</a></li> </ul>
WIRELESS SETTINGS	There are two ways to set up your IPv6 Internet connection. You can use the Web-based IPv6 Internet Connection Setup Wizard, or you can manually configure the connection.				
NETWORK SETTINGS	<b>IPv6 INTERNET CONNECTION SETUP WIZARD</b>				
STORAGE	If you would like to utilize our easy to use Web-based Wizard to assist you in connecting your new D-Link Systems Router to the IPv6 Internet, click on the button below.				
MEDIA SERVER	<a href="#">IPv6 Internet Connection Setup Wizard</a>				
IPv6	<b>Note:</b> Before launching the wizards, please make sure you have followed all steps outlined in the Quick Installation Guide included in the package.				
MYDLINK SETTINGS	<b>MANUAL IPv6 LOCAL CONNECTIVITY SETUP</b>				
	If you would like to configure the IPv6 local connectivity settings of your D-Link Router, then click on the button below.				
	<a href="#">IPv6 Local Connectivity Settings</a>				
	<b>MANUAL IPv6 INTERNET CONNECTION SETUP</b>				
	If you would like to configure the IPv6 Internet settings of your new D-Link Router manually, then click on the button below.				
	<a href="#">Manual IPv6 Internet Connection Setup</a>				
<b>WIRELESS</b>					



Click on **Enable ULA**. You can check **Use default ULA prefix**, or you can leave the box unchecked and enter the prefix manually in the **ULA Prefix** text box.

### IPV6 LOCAL CONNECTIVITY SETTINGS

Use this section to configure Unique Local IPv6 Unicast Address (ULA) settings for your router. ULA is intended for local communications and not expected to be routable on the global Internet.

### IPV6 ULA SETTINGS

Enable ULA :

Use default ULA prefix :

ULA Prefix :  /64

### CURRENT IPV6 ULA SETTINGS

Current ULA Prefix : /64

LAN IPv6 ULA : /64

## IPv6 Internet Connection Setup Wizard

On this page, the user can configure the IPv6 Connection type using the IPv6 Internet Connection Setup Wizard.

Click the **IPv6 Internet Connection Setup Wizard** button and the router will guide you through a few simple steps to get your network up and running.

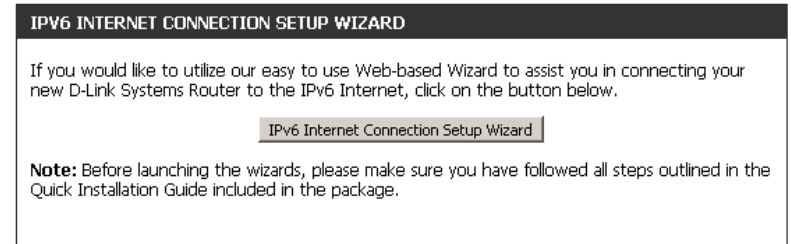

Click **Next** to continue to the next page. Click **Cancel** to discard the changes made and return to the main page.

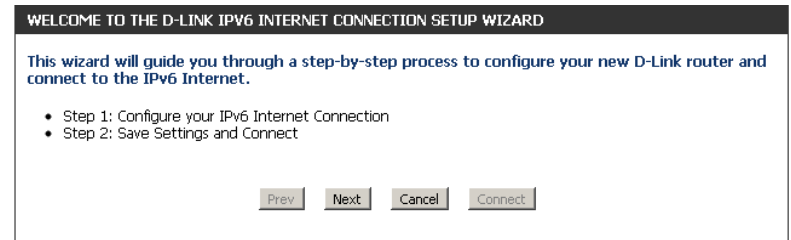

The router will try to detect whether its possible to obtain the IPv6 Internet connection type automatically. If this succeeds then the user will be guided through the input of the appropriate parameters for the connection type found.

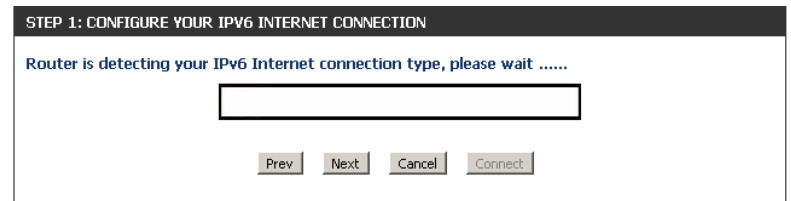

However, if the automatic detection fails, the user will be prompt to either **Try again** or to click on the **Guide me through the IPv6 settings** button to initiate the manual continual of the wizard.

There are several connection types to choose from. If you are unsure of your connection method, please contact your IPv6 Internet Service Provider.

**Note:** *If using the PPPoE option, you will need to ensure that any PPPoE client software on your computers has been removed or disabled. The 3 options available on this page are **IPv6 over PPPoE, Static IPv6 address and Route, and Tunneling Connection (6rd).***

Choose the required IPv6 Internet Connection type and click on the **Next** button to continue. Click on the **Prev** button to return to the previous page. Click on the **Cancel** button to discard all the changes made and return to the main page.

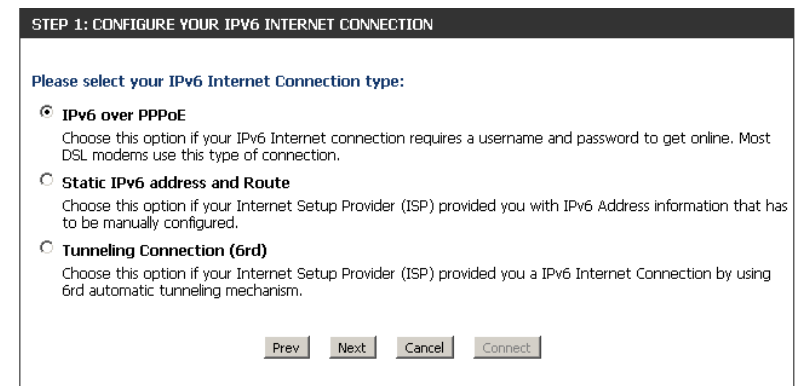
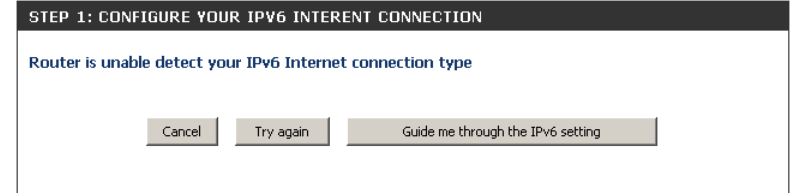

## IPv6 over PPPoE

After selecting the IPv6 over PPPoE option, the user will be able to configure the IPv6 Internet connection that requires a username and password to get online. Most DSL modems use this type of connection.

The following parameters will be available for configuration:

**PPPoE Session:** Select the PPPoE Session value used here. This option will state that this connection shares its information with the already configured IPv6 PPPoE connection, or the user can create a new PPPoE connection here.

**User Name:** Enter the PPPoE username used here. If you do not know your user name, please contact your ISP.

**Password:** Enter the PPPoE password used here. If you do not know your password, please contact your ISP.

**Verify Password:** Re-enter the PPPoE password used here.

**Service Name:** Enter the service name for this connection here. This option is optional.

**SET USERNAME AND PASSWORD CONNECTION (PPPoE)**

To set up this connection you will need to have a Username and Password from your IPv6 Internet Service Provider. If you do not have this information, please contact your ISP.

**PPPoE Session:**  Share with IPv4  Create a new session

**Username :**

**Password :**

**Verify Password :**

**Service Name :**  (Optional)

Note: You may also need to provide a Service Name. If you do not have or know this information, please contact your ISP.

## Static IPv6 Address Connection

This mode is used when your ISP provides you with a set IPv6 addresses that does not change. The IPv6 information is manually entered in your IPv6 configuration settings. You must enter the IPv6 address, Subnet Prefix Length, Default Gateway, Primary DNS Server, and Secondary DNS Server. Your ISP provides you with all this information.

**Use Link-Local Address:** The Link-local address is used by nodes and routers when communicating with neighboring nodes on the same link. This mode enables IPv6-capable devices to communicate with each other on the LAN side.

**IPv6 Address:** Enter the WAN IPv6 address for the router here.

**Subnet Prefix Length:** Enter the WAN subnet prefix length value used here.

**Default Gateway:** Enter the WAN default gateway IPv6 address used here.

**Primary DNS Address:** Enter the WAN primary DNS Server address used here.

**Secondary DNS Address:** Enter the WAN secondary DNS Server address used here.

**LAN IPv6 Address:** These are the settings of the LAN (Local Area Network) IPv6 interface for the router. The router's LAN IPv6 Address configuration is based on the IPv6 Address and Subnet assigned by your ISP. (A subnet with prefix /64 is supported in LAN.)

**SET STATIC IPV6 ADDRESS CONNECTION**

To set up this connection you will need to have a complete list of IPv6 information provided by your IPv6 Internet Service Provider. If you have a Static IPv6 connection and do not have this information, please contact your ISP.

Use Link-Local Address :

IPv6 Address :

Subnet Prefix Length :

Default Gateway :

Primary IPv6 DNS Address :

Secondary IPv6 DNS Address :

LAN IPv6 Address :  /64

## Tunneling Connection (6rd)

After selecting the Tunneling Connection (6rd) option, the user can configure the IPv6 6rd connection settings.

The following parameters will be available for configuration:

**6rd IPv6 Prefix:** Enter the 6rd IPv6 address and prefix value used here.

**IPv4 Address:** Enter the IPv4 address used here.

**Mask Length:** Enter the IPv4 mask length used here.

**Assigned IPv6 Prefix:** Displays the IPv6 assigned prefix value here.

**6rd Border Relay IPv4 Address:** Enter the 6rd border relay IPv4 address used here.

**IPv6 DNS Server:** Enter the primary DNS Server address used here.

The screenshot shows a configuration window titled "SET UP 6RD TUNNELING CONNECTION". Below the title is a message: "To set up this 6rd tunneling connection you will need to have the following information from your IPv6 Internet Service Provider. If you do not have this information, please contact your ISP." The window contains several input fields: "6rd IPv6 Prefix" with a slash and a smaller box, "IPv4 Address" with the value "10.10.10.100" and a "Mask Length" field, "Assigned IPv6 Prefix", "6rd Border Relay IPv4 Address", and "IPv6 DNS Server". At the bottom are four buttons: "Prev", "Next", "Cancel", and "Connect".

The IPv6 Internet Connection Setup Wizard is complete.

Click on the **Connect** button to continue. Click on the **Prev** button to return to the previous page. Click on the **Cancel** button to discard all the changes made and return to the main page.

The screenshot shows a confirmation window titled "SETUP COMPLETE!". Below the title is a message: "The IPv6 Internet Connection Setup Wizard has completed. Click the Connect button to save your settings and reboot the router." At the bottom are four buttons: "Prev", "Next", "Cancel", and "Connect".

## IPv6 Manual Setup

There are several connection types to choose from: **Auto Detection**, **Static IPv6**, **Autoconfiguration (SLAAC/DHCPv6)**, **PPPoE**, **IPv6 in IPv4 Tunnel**, **6to4**, **6rd**, and **Local Connectivity Only**. If you are unsure of your connection method, please contact your IPv6 Internet Service Provider.

**Note:** If using the PPPoE option, you will need to ensure that any PPPoE client software on your computers has been removed or disabled.

### Auto Detection

Select **Auto Detection** to have the router detect and automatically configure your IPv6 setting from your ISP.

Click **Save Settings**.

IPv6 CONNECTION TYPE
<p>Choose the mode to be used by the router to connect to the IPv6 Internet.</p> <p>My IPv6 Connection is : <input type="text" value="Auto Detection"/></p>
IPv6 DNS SETTINGS
<p>Obtain DNS server address automatically or enter a specific DNS server address.</p> <p><input checked="" type="radio"/> Obtain IPv6 DNS Servers automatically</p> <p><input type="radio"/> Use the following IPv6 DNS Servers</p> <p>Primary DNS Server : <input type="text"/></p> <p>Secondary DNS Server : <input type="text"/></p>
LAN IPv6 ADDRESS SETTINGS
<p>Use this section to configure the internal network settings of your router. If you change the LAN IPv6 Address here, you may need to adjust your PC network settings to access the network again.</p> <p>Enable DHCP-PD : <input checked="" type="checkbox"/></p> <p>LAN IPv6 Address : <input type="text" value=""/> /64</p> <p>LAN IPv6 Link-Local Address : fe80::cad3:a3ff:fe22:8a10 /64</p>
ADDRESS AUTOCONFIGURATION SETTINGS
<p>Use this section to setup IPv6 Autoconfiguration to assign IP addresses to the computers on your network. You can also enable DHCP-PD to delegate prefixes for routers in your LAN.</p> <p>Enable Automatic IPv6 address assignment : <input checked="" type="checkbox"/></p> <p>Enable Automatic DHCP-PD in LAN : <input checked="" type="checkbox"/></p> <p>Autoconfiguration Type : <input type="text" value="SLAAC+Stateless DHCP"/></p> <p>Router Advertisement Lifetime : <input type="text" value=""/> (minutes)</p>
<p><input type="button" value="Save Settings"/> <input type="button" value="Don't Save Settings"/></p>

## Static IPv6

**My IPv6 Connection is:** Select **Static IPv6** from the drop-down menu.

**WAN IPv6 Address Settings:** Enter the address settings supplied by your Internet provider (ISP).

**LAN IPv6 Address:** Enter the LAN (local) IPv6 address for the router.

**LAN IPv6 Link-Local Address:** Displays the Router's LAN Link-Local Address.

**Enable Automatic IPv6 address assignment:** Check to enable the Autoconfiguration feature.

**Autoconfiguration Type:** Select **Stateful (DHCPv6)**, **SLAAC + RDNSS** or **SLAAC + Stateless DHCPv6**.

**IPv6 Address Range Start:** Enter the start IPv6 Address for the DHCPv6 range for your local computers.

**IPv6 Address Range End:** Enter the end IPv6 Address for the DHCPv6 range for your local computers.

**Router Advertisement Lifetime:** Enter the Router Advertisement Lifetime (in minutes).

Click **Save Settings**.

IPv6 CONNECTION TYPE	
Choose the mode to be used by the router to connect to the IPv6 Internet.	
My IPv6 Connection is :	<input type="text" value="Static IPv6"/>
WAN IPv6 ADDRESS SETTINGS	
Enter the IPv6 address information provided by your Internet Service Provider (ISP).	
Use Link-Local Address :	<input checked="" type="checkbox"/>
IPv6 Address :	<input type="text" value="fe80::cad3:a3ff:fe22:8a13"/>
Subnet Prefix Length :	<input type="text" value="64"/>
Default Gateway :	<input type="text"/>
Primary DNS Server :	<input type="text"/>
Secondary DNS Server :	<input type="text"/>
LAN IPv6 ADDRESS SETTINGS	
Use this section to configure the internal network settings of your router. If you change the LAN IPv6 Address here, you may need to adjust your PC network settings to access the network again.	
LAN IPv6 Address :	<input type="text"/> /64
LAN IPv6 Link-Local Address :	fe80::cad3:a3ff:fe22:8a10 /64
ADDRESS AUTOCONFIGURATION SETTINGS	
Use this section to setup IPv6 Autoconfiguration to assign IP addresses to the computers on your network.	
Enable Automatic IPv6 address assignment :	<input checked="" type="checkbox"/>
Autoconfiguration Type :	<input type="text" value="SLAAC+Stateless DHCP"/>
Router Advertisement Lifetime :	<input type="text"/> (minutes)
<input type="button" value="Save Settings"/> <input type="button" value="Don't Save Settings"/>	



## Autoconfiguration

**My IPv6 Connection is:** Select **Autoconfiguration (Stateless/DHCPv6)** from the drop-down menu.

**IPv6 DNS Settings:** Select either **Obtain DNS server address automatically** or **Use the following DNS Address.**

**Primary/Secondary DNS Server:** Enter the primary and secondary DNS server addresses.

**LAN IPv6 Address:** Enter the LAN (local) IPv6 address for the router.

**LAN IPv6 Link-Local Address:** Displays the Router's LAN Link-Local Address.

**Enable Automatic IPv6 address assignment:** Check to enable the Autoconfiguration feature.

**Autoconfiguration Type:** Select **Stateful (DHCPv6)**, **SLAAC + RDNSS** or **SLAAC + Stateless DHCPv6.**

**IPv6 Address Range Start:** Enter the start IPv6 Address for the DHCPv6 range for your local computers.

**IPv6 Address Range End:** Enter the end IPv6 Address for the DHCPv6 range for your local computers.

**Router Advertisement Lifetime:** Enter the Router Advertisement Lifetime (in minutes).

**Lifetime:**

Click **Save Settings.**

**IPv6 CONNECTION TYPE**

Choose the mode to be used by the router to connect to the IPv6 Internet.

My IPv6 Connection is :

---

**IPv6 DNS SETTINGS**

Obtain DNS server address automatically or enter a specific DNS server address.

Obtain IPv6 DNS Servers automatically  
 Use the following IPv6 DNS Servers

Primary DNS Server :

Secondary DNS Server :

---

**LAN IPv6 ADDRESS SETTINGS**

Use this section to configure the internal network settings of your router. If you change the LAN IPv6 Address here, you may need to adjust your PC network settings to access the network again.

Enable DHCP-PD :

LAN IPv6 Address :  /64

LAN IPv6 Link-Local Address : fe80::cad3:a3ff:fe23:2d88 /64

---

**ADDRESS AUTOCONFIGURATION SETTINGS**

Use this section to setup IPv6 Autoconfiguration to assign IP addresses to the computers on your network. You can also enable DHCP-PD to delegate prefixes for routers in your LAN.

Enable Automatic IPv6 address assignment :

Enable Automatic DHCP-PD in LAN :

Autoconfiguration Type :

Router Advertisement Lifetime :  (minutes)

## PPPoE

**My IPv6 Connection is:** Select **PPPoE** from the drop-down menu.

**PPPoE Internet Connection Type:** Enter the PPPoE account settings supplied by your Internet provider (ISP).

**PPPoE Session:** Select **Create a new session** if you have IPv6.

**Address Mode:** Select **Static IP** if your ISP assigned you the IP address, subnet mask, gateway, and DNS server addresses. In most cases, select **Dynamic IP**.

**IP Address:** Enter the IP address (Static PPPoE only).

**User Name:** Enter your PPPoE username.

**Password:** Enter your PPPoE password and then retype the password in the next box.

**Service Name:** Enter the ISP Service Name (optional).

**Reconnect Mode:** Select either **Always-on**, **On-Demand**, or **Manual**.

**Maximum Idle Time:** Enter a maximum idle time during which the Internet connection is maintained during inactivity. To disable this feature, enable Auto-reconnect.

**MTU:** Maximum Transmission Unit - you may need to change the MTU for optimal performance with your specific ISP. 1492 is the default MTU.

**IPv6 DNS Settings:** Select either **Obtain IPv6 DNS servers automatically** or **Use the following IPv6 DNS Servers**

**Primary/Secondary DNS Servers:** Enter the primary and secondary DNS server addresses.

**IPv6 CONNECTION TYPE**

Choose the mode to be used by the router to connect to the IPv6 Internet.

My IPv6 Connection is :

---

**PPPOE INTERNET CONNECTION TYPE :**

Enter the information provided by your Internet Service Provider (ISP).

PPPoE Session :  Share with IPv4  Create a new session

Address Mode :  Dynamic IP  Static IP

IP Address :

Username :

Password :

Verify Password :

Service Name :  (optional)

Reconnect Mode :  Always on  On demand  Manual

Maximum Idle Time :  (minutes, 0=infinite)

MTU :  (bytes) MTU default = 1492

---

**IPv6 DNS SETTINGS**

Obtain DNS server address automatically or enter a specific DNS server address.

Obtain IPv6 DNS Servers automatically

Use the following IPv6 DNS Servers

Primary DNS Server :

Secondary DNS Server :

---

**LAN IPv6 ADDRESS SETTINGS**

Use this section to configure the internal network settings of your router. If you change the LAN IPv6 Address here, you may need to adjust your PC network settings to access the network again.

Enable DHCP-PD :

LAN IPv6 Address :  /64

LAN IPv6 Link-Local Address : fe80::cad3:a3ff:fe22:8a10 /64

---

**ADDRESS AUTOCONFIGURATION SETTINGS**

Use this section to setup IPv6 Autoconfiguration to assign IP addresses to the computers on your network. You can also enable DHCP-PD to delegate prefixes for routers in your LAN.

Enable Automatic IPv6 address assignment :

Enable Automatic DHCP-PD in LAN :

Autoconfiguration Type :

Router Advertisement Lifetime :  (minutes)

**Enable DHCP-PD:** Check to enable DHCP-PD.

**LAN IPv6 Address:** Enter the LAN (local) IPv6 address for the router.

**LAN IPv6 Link-Local Address:** Displays the Router's LAN Link-Local Address.

**Enable Automatic IPv6 address assignment:** Check to enable the IPv6 Autoconfiguration.

**Enable Automatic DHCP-PD in LAN:** Check to enable delegation of prefixes for router addresses.

**Autoconfiguration Type:** Select **Stateful (DHCPv6)**, **SLAAC + RDNSS** or **SLAAC + Stateless DHCPv6**.

**IPv6 Address Range Start:** Enter the start IPv6 Address for the DHCPv6 range for your local computers.

**IPv6 Address Range End:** Enter the end IPv6 Address for the DHCPv6 range for your local computers.

**Router Advertisement Lifetime:** Enter the Router Advertisement Lifetime (in minutes).

Click **Save Settings**.

**LAN IPv6 ADDRESS SETTINGS**

Use this section to configure the internal network settings of your router. If you change the LAN IPv6 Address here, you may need to adjust your PC network settings to access the network again.

Enable DHCP-PD :

LAN IPv6 Address :  /64

LAN IPv6 Link-Local Address : fe80::cad3:a3ff:fe24:9048 /64

**ADDRESS AUTOCONFIGURATION SETTINGS**

Use this section to setup IPv6 Autoconfiguration to assign IP addresses to the computers on your network. You can also enable DHCP-PD to delegate prefixes for routers in your LAN.

Enable Automatic IPv6 address assignment :

Enable Automatic DHCP-PD in LAN :

Autoconfiguration Type : SLAAC+Stateless DHCPv6

Router Advertisement Lifetime :  (minutes)

## IPv6 in IPv4 Tunneling

**My IPv6 Connection is:** Select **IPv6 in IPv4 Tunnel** from the drop-down menu.

### IPv6 in IPv4 Tunnel

**Settings:** Enter the settings supplied by your Internet provider (ISP).

**IPv6 DNS Settings:** Select either **Obtain IPv6 DNS servers automatically** or **Use the following IPv6 DNS Servers**

**Primary/Secondary DNS Servers:** Enter the primary and secondary DNS server addresses.

**LAN IPv6 Address:** Enter the LAN (local) IPv6 address for the router.

**LAN IPv6 Link-Local Address:** Displays the Router's LAN Link-Local Address.

**Enable Automatic IPv6 Address Assignment:** Check to enable the Autoconfiguration feature.

**Enable Automatic DHCP-PD in LAN:** Check to enable delegation of prefixes for router addresses.

**Autoconfiguration Type:** Select **Stateful (DHCPv6)**, **SLAAC + RDNSS** or **SLAAC + Stateless DHCPv6**.

**IPv6 Address Range Start:** Enter the start IPv6 Address for the DHCPv6 range for your local computers.

**IPv6 Address Range End:** Enter the end IPv6 Address for the DHCPv6 range for your local computers.

**Router Advertisement Lifetime:** Enter the Router Advertisement Lifetime (in minutes).

Click **Save Settings**.

IPv6 CONNECTION TYPE	
Choose the mode to be used by the router to connect to the IPv6 Internet.	
My IPv6 Connection is :	IPv6 in IPv4 Tunnel
IPv6 IN IPv4 TUNNEL SETTINGS	
Enter the IPv6 in IPv4 Tunnel information provided by your Tunnel Broker.	
Remote IPv4 Address :	<input type="text"/>
Remote IPv6 Address :	<input type="text"/>
Local IPv4 Address :	<input type="text"/>
Local IPv6 Address :	<input type="text"/>
Subnet Prefix Length :	<input type="text"/>
IPv6 DNS SETTINGS	
Obtain DNS server address automatically or enter a specific DNS server address.	
<input checked="" type="radio"/> Obtain IPv6 DNS Servers automatically <input type="radio"/> Use the following IPv6 DNS Servers	
Primary DNS Server :	<input type="text"/>
Secondary DNS Server :	<input type="text"/>
LAN IPv6 ADDRESS SETTINGS	
Use this section to configure the internal network settings of your router. If you change the LAN IPv6 Address here, you may need to adjust your PC network settings to access the network again.	
Enable DHCP-PD :	<input checked="" type="checkbox"/>
LAN IPv6 Address :	<input type="text"/> /64
LAN IPv6 Link-Local Address :	fe80::cad3:a3ff:fe22:8a10 /64
ADDRESS AUTOCONFIGURATION SETTINGS	
Use this section to setup IPv6 Autoconfiguration to assign IP addresses to the computers on your network.	
Enable Automatic IPv6 address assignment :	<input checked="" type="checkbox"/>
Enable Automatic DHCP-PD in LAN :	<input checked="" type="checkbox"/>
Autoconfiguration Type :	SLAAC+Stateless DHCP
Router Advertisement Lifetime :	<input type="text"/> (minutes)
<input type="button" value="Save Settings"/> <input type="button" value="Don't Save Settings"/>	

## 6 to 4 Tunneling

**My IPv6 Connection is:** Select **6 to 4** from the drop-down menu.

**WAN IPv6 Address Settings:** Enter the IPv6 settings supplied by your Internet provider (ISP).

**Primary/Secondary DNS Servers:** Enter the primary and secondary DNS server addresses.

**LAN IPv6 Address:** Enter the LAN (local) IPv6 address for the router.

**LAN IPv6 Link-Local Address:** Displays the Router's LAN Link-Local Address.

**Enable Automatic IPv6 Address Assignment:** Check to enable the Autoconfiguration feature.

**Autoconfiguration Type:** Select **Stateful (DHCPv6)**, **SLAAC + RDNSS** or **SLAAC + Stateless DHCPv6**.

**IPv6 Address Range Start:** Enter the start IPv6 Address for the DHCPv6 range for your local computers.

**IPv6 Address Range End:** Enter the end IPv6 Address for the DHCPv6 range for your local computers.

**Router Advertisement Lifetime:** Enter the Router Advertisement Lifetime (in minutes).

Click **Save Settings**.

IPv6 CONNECTION TYPE	
Choose the mode to be used by the router to connect to the IPv6 Internet.	
My IPv6 Connection is :	<input type="text" value="6to4"/>
WAN IPv6 ADDRESS SETTINGS	
Enter the IPv6 address information provided by your Internet Service Provider (ISP).	
6to4 Address :	<input type="text"/>
6to4 Relay :	<input type="text"/>
Primary DNS Server :	<input type="text"/>
Secondary DNS Server :	<input type="text"/>
LAN IPv6 ADDRESS SETTINGS	
Use this section to configure the internal network settings of your router. If you change the LAN IPv6 Address here, you may need to adjust your PC network settings to access the network again.	
LAN IPv6 Address :	xxxx:xxxx:xxxx: <input type="text"/> ::1 /64
LAN IPv6 Link-Local Address :	fe80::cad3:a3ff:fe22:8a10 /64
ADDRESS AUTOCONFIGURATION SETTINGS	
Use this section to setup IPv6 Autoconfiguration to assign IP addresses to the computers on your network.	
Enable Automatic IPv6 address assignment :	<input checked="" type="checkbox"/>
Autoconfiguration Type :	<input type="text" value="SLAAC+Stateless DHCP"/>
Router Advertisement Lifetime :	<input type="text"/> (minutes)
<input type="button" value="Save Settings"/> <input type="button" value="Don't Save Settings"/>	

## 6rd

**My IPv6 Connection is:** Select **6rd** from the drop-down menu.

**WAN IPv6 Address Settings:** Enter the address settings supplied by your Internet provider (ISP).

**LAN IPv6 Address:** Enter the LAN (local) IPv6 address for the router.

**LAN IPv6 Link-Local Address:** Displays the Router's LAN Link-Local Address.

**Enable Automatic IPv6 address assignment:** Check to enable the Autoconfiguration feature.

**Autoconfiguration Type:** Select **Stateful (DHCPv6)**, **SLAAC+RDNSS** or **SLAAC + Stateless DHCPv6**.

**Router Advertisement Lifetime:** Enter the Router Advertisement Lifetime (in minutes).

Click **Save Settings**.

IPv6 CONNECTION TYPE	
Choose the mode to be used by the router to connect to the IPv6 Internet.	
My IPv6 Connection is : <input type="text" value="6rd"/>	
WAN IPv6 ADDRESS SETTINGS	
Enter the IPv6 address information provided by your Internet Service Provider (ISP).	
Enable Hub and Spoke Mode : <input type="checkbox"/>	
6rd Configuration : <input checked="" type="radio"/> 6rd DHCPv4 option <input type="radio"/> Manual Configuration	
6rd IPv6 Prefix : <input type="text"/> / <input type="text"/>	
IPv4 Address : <input type="text"/> Mask Length : <input type="text"/>	
Assigned IPv6 Prefix : <input type="text"/>	
6rd Border Relay IPv4 Address : <input type="text"/>	
Primary DNS Server : <input type="text"/>	
Secondary DNS Server : <input type="text"/>	
LAN IPv6 ADDRESS SETTINGS	
Use this section to configure the internal network settings of your router. If you change the LAN IPv6 Address here, you may need to adjust your PC network settings to access the network again.	
LAN IPv6 Address : <input type="text"/>	
LAN IPv6 Link-Local Address : fe80::cad3:a3ff:fe22:8a10 /64	
ADDRESS AUTOCONFIGURATION SETTINGS	
Use this section to setup IPv6 Autoconfiguration to assign IP addresses to the computers on your network.	
Enable Automatic IPv6 address assignment : <input checked="" type="checkbox"/>	
Autoconfiguration Type : <input type="text" value="SLAAC+Stateless DHCP"/>	
Router Advertisement Lifetime : <input type="text"/> (minutes)	
<input type="button" value="Save Settings"/> <input type="button" value="Don't Save Settings"/>	

## Local Connectivity

**My IPv6 Connection is:** Select **Local Connectivity Only** from the drop-down menu.

**LAN IPv6 Link-Local Address:** Displays the IPv6 address of the router.

Click **Save Settings**.

The screenshot shows a configuration page for IPv6 settings. It is divided into two main sections: 'IPv6 CONNECTION TYPE' and 'LAN IPv6 ADDRESS SETTINGS'. The 'IPv6 CONNECTION TYPE' section has a header and a blue instruction: 'Choose the mode to be used by the router to connect to the IPv6 Internet.' Below this, there is a label 'My IPv6 Connection is :' followed by a dropdown menu currently set to 'Local Connectivity Only'. The 'LAN IPv6 ADDRESS SETTINGS' section has a header and a grey instruction: 'Use this section to configure the internal network settings of your router.' Below this, there is a label 'LAN IPv6 Link-Local Address :' followed by the value 'fe80::cad3:a3ff:fe22:8a10 /64'. At the bottom of the form, there are two buttons: 'Save Settings' and 'Don't Save Settings'.

## mydlink Settings

The DIR-868L features a cloud service that pushes information such as firmware upgrade notifications, user activity, and intrusion alerts to the mydlink™ app on Android and Apple mobile devices. To insure that your router is up-to-date with the latest features, mydlink™ will notify you when an update is available for your router. You can also monitor a user's online activity with real-time website browsing history, maintaining a safe and secure environment, especially for children at home.

On this page the user can configure the mydlink™ settings for this router. This feature will allow us to use the mydlink cloud services that includes online access and management of this router through the mydlink portal website or portable device applications like iOS apps and Android applications.

In the mydlink section, we can view the registration status of the mydlink account service. The mydlink Service field will either display Registered or Non-Registered. In the Register mydlink Service section, we can register or modify a mydlink account. Click on the **Register mydlink Service** button to initiate this procedure.

**mydlink Service:** Displays whether your device is registered with a mydlink account or not. If you are registered, your mydlink e-mail address will be displayed.

**Register mydlink Service:** Click to go to the mydlink website to register or edit your settings. Please refer to page 19 for the registration steps.

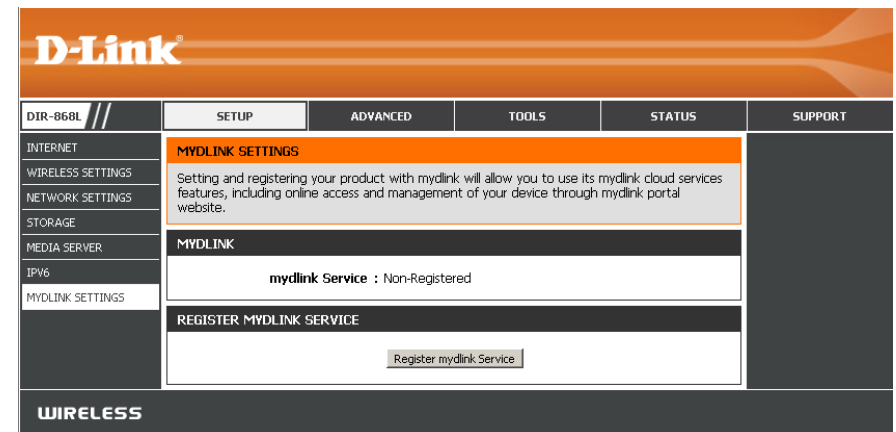



# Advanced Virtual Server

This will allow you to open a single port. If you would like to open a range of ports, refer to the next page.

**Name:** Enter a name for the rule or select an application from the drop-down menu. Select an application and click << to populate the fields.

**IP Address:** Enter the IP address of the computer on your local network that you want to allow the incoming service to. If your computer is receiving an IP address automatically from the router (DHCP), you computer will be listed in the "Computer Name" drop-down menu. Select your computer and click <<.

**Private Port/ Public Port:** Enter the port that you want to open next to Private Port and Public Port. The private and public ports are usually the same. The public port is the port seen from the Internet side, and the private port is the port being used by the application on the computer within your local network.

**Protocol Type:** Select **TCP**, **UDP**, or **Both** from the drop-down menu.

**Schedule:** The schedule of time when the Virtual Server Rule will be enabled. The schedule may be set to Always, which will allow the particular service to always be enabled. You can create your own times in the **Tools** > **Schedules** section.

**Inbound Filter:** Select **Allow All** (most common) or a created Inbound filter. You may create your own inbound filters in the **Advanced** > **Inbound Filter** page.

**D-Link**

DIR-868L //

SETUP ADVANCED TOOLS STATUS SUPPORT

**VIRTUAL SERVER**

The Virtual Server option allows you to define a single public port on your router for redirection to an internal LAN IP Address and Private LAN port if required. This feature is useful for hosting online services such as FTP or Web Servers.

Save Settings Don't Save Settings

**24 - VIRTUAL SERVERS LIST**

Remaining number of rules that can be created: 24

	Name	IP Address	Public Port	Private Port	Protocol	Schedule	Inbound Filter
<input type="checkbox"/>	<< Application name	<< Computer Name			Both	Always	Allow All
<input type="checkbox"/>	<< Application name	<< Computer Name			Both	Always	Allow All
<input type="checkbox"/>	<< Application name	<< Computer Name			Both	Always	Allow All
<input type="checkbox"/>	<< Application name	<< Computer Name			Both	Always	Allow All

**Helpful Hints...**

- Check the **Application Name** drop down menu for a list of predefined server types. If you select one of the predefined server types, click the arrow button next to the drop down menu to fill out the corresponding field.
- You can select a computer from the list of DHCP clients in the **Computer Name** drop down menu, or you can manually enter the IP address of the computer at which you would like to open the specified port.
- Select a schedule for when the virtual server will be enabled. If you do not see the schedule you need in the list of schedules, go to the **Tools** -> **Schedules** screen and create a new schedule.
- Select a filter that restricts the Internet hosts that can access this virtual server to hosts that you trust. If you do

## Port Forwarding

This will allow you to open a single port or a range of ports.

**Name:** Enter a name for the rule or select an application from the drop-down menu. Select an application and click << to populate the fields.

**IP Address:** Enter the IP address of the computer on your local network that you want to allow the incoming service to. If your computer is receiving an IP address automatically from the router (DHCP), you computer will be listed in the "Computer Name" drop-down menu. Select your computer and click <<.

**TCP/UDP:** Enter the TCP and/or UDP port or ports that you want to open. You can enter a single port or a range of ports. Separate ports with a comma.

Example: 24,1009,3000-4000

**Schedule:** The schedule of time when the Virtual Server Rule will be enabled. The schedule may be set to **Always**, which will allow the particular service to always be enabled. You can create your own times in the **Tools > Schedules** section.

**Inbound Filter:** Select **Allow All** (most common) or a created Inbound filter. You may create your own inbound filters in the **Advanced > Inbound Filter** page.

**D-Link**

DIR-868L // SETUP ADVANCED TOOLS STATUS SUPPORT

**PORT FORWARDING**

This option is used to open multiple ports or a range of ports in your router and redirect data through those ports to a single PC on your network. This feature allows you to enter ports in the format, Port Ranges (100-150), Individual Ports (80, 68, 888), or Mixed (1020-5000, 689). This option is only applicable to the INTERNET session.

Save Settings Don't Save Settings

**24 -- PORT FORWARDING RULES**

Remaining number of rules that can be created: 24

Name	IP Address	Application Name	Computer Name	Ports to Open	Inbound Filter
<input type="checkbox"/>	<input type="text"/>	<< Application Name	<< Computer Name	TCP <input type="text"/>	Schedule Always
<input type="checkbox"/>	<input type="text"/>	<< Application Name	<< Computer Name	UDP <input type="text"/>	Inbound Filter Allow All
<input type="checkbox"/>	<input type="text"/>	<< Application Name	<< Computer Name	TCP <input type="text"/>	Schedule Always
<input type="checkbox"/>	<input type="text"/>	<< Application Name	<< Computer Name	UDP <input type="text"/>	Inbound Filter Allow All

**Helpful Hints...**

- Check the **Application Name** drop-down menu for a list of pre-defined applications that you can select from. If you select one of the pre-defined applications, click the arrow button next to the drop-down menu to fill out the appropriate fields.
- You can select your computer from the list of DHCP clients in the **Computer Name** drop-down menu, or enter the IP address manually of the computer you would like to open the specified port to.
- Select a schedule for when the port forwarding will be enabled. If you do not see the schedule you need in the list of schedules, go to the **Tools -> Schedules** screen and create a new schedule.
- You can enter ports in various formats: Range (50-100) Individual (80, 68, 888) Mixed (1020-

## Application Rules

Some applications require multiple connections, such as Internet gaming, video conferencing, Internet telephony and others. These applications have difficulties working through NAT (Network Address Translation). Special Applications makes some of these applications work with the DIR-868L. If you need to run applications that require multiple connections, specify the port normally associated with an application in the "Trigger Port" field, select the protocol type as TCP or UDP, then enter the firewall (public) ports associated with the trigger port to open them for inbound traffic.

The DIR-868L provides some predefined applications in the table on the bottom of the web page. Select the application you want to use and enable it.

**Name:** Enter a name for the rule. You may select a pre-defined application from the drop-down menu and click <<.

**Trigger:** This is the port used to trigger the application. It can be either a single port or a range of ports.

**Traffic Type:** Select the protocol of the trigger port (TCP, UDP, or Both).

**Firewall:** This is the port number on the Internet side that will be used to access the application. You may define a single port or a range of ports. You can use a comma to add multiple ports or port ranges.

**Traffic Type:** Select the protocol of the firewall port (TCP, UDP, or Both).

**Schedule:** The schedule of time when the Application Rule will be enabled. The schedule may be set to Always, which will allow the particular service to always be enabled. You can create your own times in the **Tools > Schedules** section.

The screenshot shows the D-Link DIR-868L web interface. The top navigation bar includes 'DIR-868L', 'SETUP', 'ADVANCED', 'TOOLS', 'STATUS', and 'SUPPORT'. The 'ADVANCED' tab is selected, and the 'APPLICATION RULES' sub-tab is active. The main content area displays the 'APPLICATION RULES' configuration page, which includes a description of the feature and a table of predefined application rules. The table has columns for 'Name', 'Application', 'Trigger', 'Firewall', 'Traffic Type', and 'Schedule'. The 'Remaining number of rules that can be created: 24' is shown above the table. The 'Helpful Hints...' sidebar on the right provides additional information and instructions.

Name	Application	Trigger	Firewall	Traffic Type	Schedule
<input type="checkbox"/>	<< Application Name >>	<input type="text"/>	<input type="text"/>	All	Always
<input type="checkbox"/>	<< Application Name >>	<input type="text"/>	<input type="text"/>	All	Always
<input type="checkbox"/>	<< Application Name >>	<input type="text"/>	<input type="text"/>	All	Always

## QoS Engine

The QoS Engine option helps improve your network gaming performance by prioritizing applications. By default the QoS Engine settings are disabled and application priority is not automatically classified. The QoS section contains a queuing mechanism, traffic shaping and classification. It supports two kinds of queuing mechanisms. Strict Priority Queue (SPQ) and Weighted Fair Queue (WFQ). SPQ will process traffic based on traffic priority. Queue1 has the highest priority and Queue4 has the lowest priority. WFQ will process traffic based on the queue weight. Users can configure each queue's weight. The sum of all the queue's weight must be 100. When surfing the Internet, the system will do traffic shaping based on the uplink and downlink speed. The classification rules can be used to classify traffic to different queues, then SPQ or WFQ will do QoS based on the queue's priority or weight.

**Enable QoS:** This option is disabled by default. Enable this option for better performance and experience with online games and other interactive applications, such as VoIP.

**Uplink Speed:** The speed at which data can be transferred from the router to your ISP. This is determined by your ISP.

**Downlink Speed:** The speed at which data can be transferred from the Internet to your router. This is determined by your ISP.

**Queue Type:** Select either **Strict Priority Queue** (rank in order) or **Weighted Fair Queue** (percentage).

**Queue ID:** The queue ID used will be displayed in the first column.

**Queue Priority:** When *Strict Priority Queue* is selected, the *Queue Priority* will be displayed in the second column.

**Queue Weight:** When the *Weighted Fair Queue* option is selected, you will be able to manually enter the *Queue Weight* for each individual Queue ID in the second column.

**D-Link**

DIR-868L // SETUP ADVANCED TOOLS STATUS SUPPORT

**QoS SETTINGS**

Use this section to configure D-Link's QoS Engine powered by QoS Engine Technology. This QoS Engine improves your online gaming experience by ensuring that your game traffic is prioritized over other network traffic, such as FTP or Web. For best performance, use the Automatic Classification option to automatically set the priority for your applications.

Save Settings Don't Save Settings

**QoS SETUP**

Enable QoS :

Uplink Speed : 2048 kbps << Select Transmission Rate

Downlink Speed : 8192 kbps << Select Transmission Rate

Queue Type :  Strict Priority Queue  Weighted Fair Queue

Queue ID	Queue Weight
1	40 %
2	30 %
3	20 %
4	10 %

**32 -- CLASSIFICATION RULES**

Remaining number of rules that can be created: 18

Name	Queue ID	Protocol
Youtube	1 - Highest	TCP << ALL

Local IP Range: [ ] to [ ]

Remote IP Range: [ ] to [ ]

Application Port: YOUTUBE << ALL

Helpful Hints...  
 • Some experimentation and performance measurement may be required to converge on the optimal value.  
 • More...

After specifying the QoS framework used, in the QoS setup section, the user can now create individual rules for scenarios that require the use of traffic control and data priority manipulation.

**Classification** The QoS Engine supports overlaps between rules, where more than one rule can match for a specific message flow. If more than one **Rules:** rule is found to match the rule with the highest priority will be used.

**Name:** Create a name for the rule that is meaningful to you.

**Queue ID:** The priority of the message flow is entered here -- 1 receives the highest priority (most urgent) and 255 receives the lowest priority (least urgent).

**Protocol:** The protocol used by the messages.

**Local IP Range:** The rule applies to a flow of messages whose LAN-side IP address falls within the range set here.

**Remote IP Range:** The rule applies to a flow of messages whose WAN-side IP address falls within the range set here.

**Application Port:** Select a service or port you want to assign to this rule.

Click on the **Save Settings** button to accept the changes made or click on the **Don't Save Settings** button to discard the changes made.

## Network Filters

Use MAC (Media Access Control) Filters to allow or deny LAN (Local Area Network) computers by their MAC addresses from accessing the network. You can either manually add a MAC address or select the MAC address from the list of clients that are currently connected to the Broadband Router.

**Configure MAC Filtering:** Select **Turn MAC Filtering Off, Allow MAC addresses listed below, or Deny MAC addresses listed below** from the drop-down menu.

**MAC Address:** Enter the MAC address you would like to filter.

To find the MAC address on a computer, please refer to the *Networking Basics* section in this manual.

**DHCP Client List:** Select a DHCP client from the drop-down menu and click << to copy that MAC Address.

**Schedule:** Select a pre-defined or user created schedule from the drop-down menu, or click **New Schedule** to create a new schedule. You set a specific time frame for the MAC filter rule to be active.

**MAC ADDRESS FILTER**

The MAC (Media Access Controller) Address filter option is used to control network access based on the MAC Address of the network adapter. A MAC address is a unique ID assigned by the manufacturer of the network adapter. This feature can be configured to ALLOW or DENY network/Internet access.

Save Settings Don't Save Settings

**24 -- MAC FILTERING RULES**

Configure MAC Filtering below:  
Turn MAC Filtering OFF

Remaining number of rules that can be created: 24

	MAC Address		DHCP Client List	Schedule
<input type="checkbox"/>		<<	Computer Name	Always New Schedule
<input type="checkbox"/>		<<	Computer Name	Always New Schedule
<input type="checkbox"/>		<<	Computer Name	Always New Schedule
<input type="checkbox"/>		<<	Computer Name	Always New Schedule
<input type="checkbox"/>		<<	Computer Name	Always New Schedule

**Helpful Hints...**

- Create a list of MAC addresses and choose whether to allow or deny them access to your network.
- Computers that have obtained an IP address from the router's DHCP server will be in the DHCP Client List. Select a device from the drop down menu and click the arrow to add that device's MAC to the list.
- Use the check box on the left to either enable or disable a particular entry.
- Use the **Always** drop down menu if you have previously defined a schedule in the router. If not, click on the **New Schedule** button to add one.
- [More...](#)

## Access Control

The Access Control section allows you to control access in and out of your network. Use this feature as Parental Controls to only grant access to approved sites, limit web access based on time or dates, and/or block access from applications like P2P utilities or games.

**Enable Access Control:** Check the **Enable Access Control** box, and then click on **Add Policy** to start the Wizard.

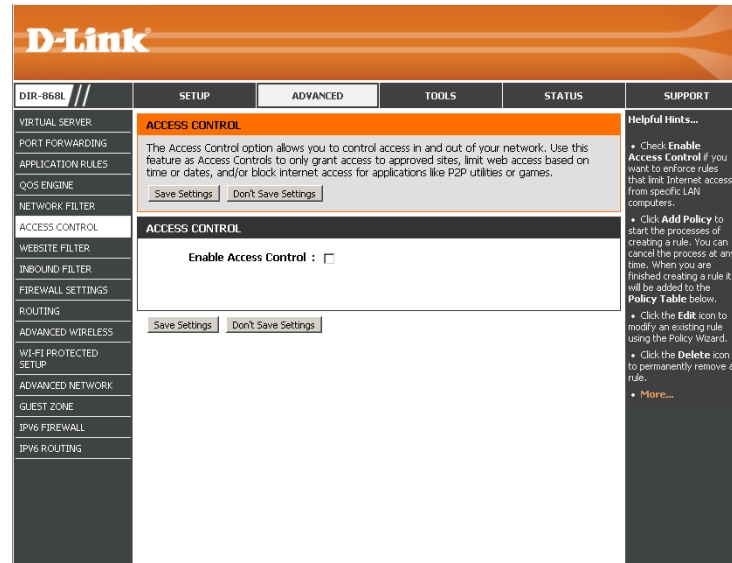

## Access Control Wizard

Click **Next** to continue with the wizard.

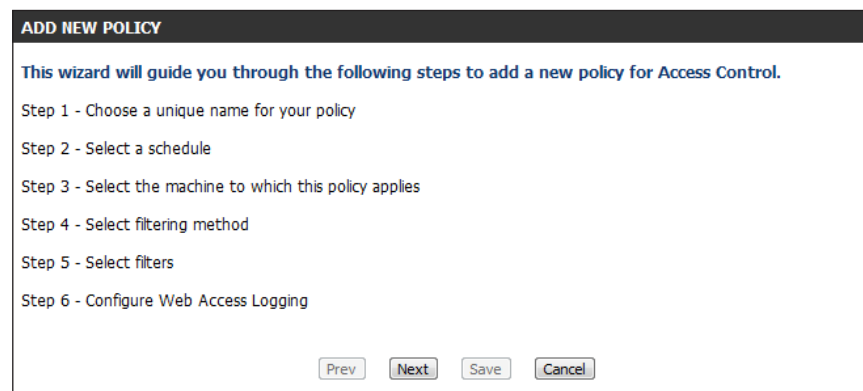

Enter a name for the policy and then click **Next** to continue.

**STEP 1: CHOOSE POLICY NAME**

Choose a unique name for your policy.

Policy Name :

Select a schedule (i.e., Always) from the drop-down menu and then click **Next** to continue.

**STEP 2: SELECT SCHEDULE**

Choose a schedule to apply to this policy.

▾

Details :

Enter the following information and then click **Next** to continue.

- **Address Type** - Select **IP**, **MAC**, or **Other Machines**.
- **IP Address** - Enter the IP address of the computer you want to apply the rule to.
- **Machine Address** - Enter the PC MAC address or click on **Clone Your PC's MAC Address**.

**STEP 3: SELECT MACHINE**

Select the machine to which this policy applies.

Specify a machine with its IP or MAC address, or select 'Other Machines' for machines that do not have a policy.

Address Type :  IP  MAC  Other Machines

IP Address :  << Computer Name ▾

Machine Address :  << Computer Name ▾

Machine

Click **Add** to continue.

Select the filtering method.

**STEP 4: SELECT FILTERING METHOD**

Select the method for filtering.

Method :  Log Web Access Only  Block All Access  Block Some Access

Apply Web Filter :

Apply Advanced Port Filters :

If you choose to *Block Some Access*, check **Apply Web Filter** and/or **Apply Advanced Port Filters**.

**STEP 4: SELECT FILTERING METHOD**

Select the method for filtering.

Method :  Log Web Access Only  Block All Access  Block Some Access

Apply Web Filter :

Apply Advanced Port Filters :

Click **Next** to continue.



**Add Port Filter Rules:**

**Enable** - Check to enable the rule.

**Name** - Enter a name for your rule.

**Dest IP Start** - Enter the starting IP address.

**Dest IP End** - Enter the ending IP address.

**Protocol** - Select the protocol.

**Dest Port Start** - Enter the starting port number.

**Dest Port End** - Enter the ending port number.

Click **Next**.

To enable **Web Access Logging**, click **Enabled**.

Click **Save** to save the access control rule.

Your newly created policy will now show up under *Policy Table*.

**STEP 5: PORT FILTER**

Add Port Filters Rules.

Specify rules to prohibit access to specific IP addresses and ports.

Enable	Name	Dest IP Start	Dest IP End	Protocol	Dest Port Start	Dest Port End
<input type="checkbox"/>		0.0.0.0	255.255.255.255	Any	1	65535
<input type="checkbox"/>		0.0.0.0	255.255.255.255	Any	1	65535
<input type="checkbox"/>		0.0.0.0	255.255.255.255	Any	1	65535
<input type="checkbox"/>		0.0.0.0	255.255.255.255	Any	1	65535
<input type="checkbox"/>		0.0.0.0	255.255.255.255	Any	1	65535
<input type="checkbox"/>		0.0.0.0	255.255.255.255	Any	1	65535
<input type="checkbox"/>		0.0.0.0	255.255.255.255	Any	1	65535
<input type="checkbox"/>		0.0.0.0	255.255.255.255	Any	1	65535

Prev Next Save Cancel

**STEP 6: CONFIGURE WEB ACCESS LOGGING**

Web Access Logging :  Disabled  
 Enabled

Prev Next Save Cancel

**ACCESS CONTROL**

The Access Control option allows you to control access in and out of your network. Use this feature as Access Controls to only grant access to approved sites, limit web access based on time or dates, and/or block internet access for applications like P2P utilities or games.

Save Settings Don't Save Settings Reboot Now

**ENABLE**

Enable Access Control :

Add Policy

**POLICY TABLE**

Enable Policy	Machine	Filtering	Logged	Schedule	
<input checked="" type="checkbox"/>	dlink	Block Some Access	No	Always	

## Website Filters

Website Filters are used to allow you to set up a list of Web sites that can be viewed by multiple users through the network. To use this feature select to **Allow** or **Deny**, enter the domain or website and click **Save Settings**. You must also select **Apply Web Filter** under the *Access Control* section (pages 82 - 83).

**Configure Website Filter:** Select either **DENY computers access to ONLY these sites** or **ALLOW computers access to ONLY these sites**.

**Website URL/ Domain:** Enter the keywords or URLs that you want to allow or block. Click **Save Settings**.

The screenshot shows the D-Link DIR-868L web interface. The top navigation bar includes 'DIR-868L //', 'SETUP', 'ADVANCED', 'TOOLS', 'STATUS', and 'SUPPORT'. The left sidebar lists various configuration options, with 'WEBSITE FILTER' selected. The main content area is titled 'WEBSITE FILTER' and contains the following text: 'The Website Filter option allows you to set up a list of Web sites you would like to allow or deny through your network. To use this feature, you must also select the "Apply Web Filter" checkbox in the Access Control section.' Below this text are two buttons: 'Save Settings' and 'Don't Save Settings'. A section titled '40 -- WEBSITE FILTERING RULES' contains the text 'Configure Website Filter below:' followed by a dropdown menu set to 'DENY computers access to ONLY these sites' and a 'Clear the list below...' button. Below these elements is a table with the header 'Website URL/Domain' and two columns for entering URLs. The right sidebar, titled 'Helpful Hints...', contains the following text: '• Create a list of Websites that you would like the devices on your network to be allowed or denied access to. • Keywords can be entered in this list in order to block any URL containing the keyword entered. • Use with **Advanced - > Access Control**. • **More...**'

## Inbound Filters

The Inbound Filter option is an advanced method of controlling data received from the Internet. With this feature you can configure inbound data filtering rules that control data based on an IP address range. Inbound Filters can be used with Virtual Server, Port Forwarding, or Remote Administration features.

**Name:** Enter a name for the inbound filter rule.

**Action:** Select **Allow** or **Deny**.

**Remote IP** Check to enable rule.

**Range: Enable:**

**Remote IP Start:** Enter the starting IP address.

**Remote IP End:** Enter the ending IP address.

**Add:** Click the **Add** button to apply your settings.

**Inbound Filter Rules List:** This section will list any rules that are created. You may click the **Edit** icon to change the settings or enable/disable the rule, or click the **Delete** icon to remove the rule.

**D-Link**

DIR-868L // SETUP ADVANCED TOOLS STATUS SUPPORT

**INBOUND FILTER**

The Inbound Filter option is an advanced method of controlling data received from the Internet. With this feature you can configure inbound data filtering rules that control data based on an IP address range.

Inbound Filters can be used for limiting access to a server on your network to a system or group of systems. Filter rules can be used with Virtual Server, Port Forwarding, or Remote Administration features.

**ADD INBOUND FILTER RULE**

Name :

Action :

Remote IP Range	Enable	Remote IP Start	Remote IP End
<input type="checkbox"/>	<input type="checkbox"/>	0.0.0.0	255.255.255.255
<input type="checkbox"/>	<input type="checkbox"/>	0.0.0.0	255.255.255.255
<input type="checkbox"/>	<input type="checkbox"/>	0.0.0.0	255.255.255.255
<input type="checkbox"/>	<input type="checkbox"/>	0.0.0.0	255.255.255.255
<input type="checkbox"/>	<input type="checkbox"/>	0.0.0.0	255.255.255.255
<input type="checkbox"/>	<input type="checkbox"/>	0.0.0.0	255.255.255.255
<input type="checkbox"/>	<input type="checkbox"/>	0.0.0.0	255.255.255.255
<input type="checkbox"/>	<input type="checkbox"/>	0.0.0.0	255.255.255.255
<input type="checkbox"/>	<input type="checkbox"/>	0.0.0.0	255.255.255.255

**INBOUND FILTER RULES LIST**

Name	Action	Remote IP Range

**WIRELESS**

**Helpful Hints...**

- Give each rule a **Name** that is meaningful to you.
- Each rule can either **Allow** or **Deny** access from the WAN.
- Up to eight ranges of WAN IP addresses can be controlled by each rule. The checkbox by each IP range can be used to disable ranges already defined.
- The starting and ending IP addresses are WAN-side address.
- Click the **Add** button to store a finished rule in the Rules List below.
- Click the **Edit** icon in the Rules List to change a rule.
- Click the **Delete** icon in the Rules List to permanently remove a rule.
- [More...](#)

## Firewall Settings

A firewall protects your network from the outside world. The DIR-868L offers a firewall type functionality. The SPI feature helps prevent cyber attacks. Sometimes you may want a computer exposed to the outside world for certain types of applications. If you choose to expose a computer, you can enable DMZ. DMZ is short for Demilitarized Zone. This option will expose the chosen computer completely to the outside world.

**Enable SPI:** SPI (Stateful Packet Inspection, also known as dynamic packet filtering) helps to prevent cyber attacks by tracking more state per session. It validates that the traffic passing through the session conforms to the protocol.

**NAT Endpoint** Select one of the following for TCP and UDP ports:

**Filtering: Endpoint Independent** - Any incoming traffic sent to an open port will be forwarded to the application that opened the port. The port will close if idle for 5 minutes.

**Address Restricted** - Incoming traffic must match the IP address of the outgoing connection.

**Port and Address Restricted** - Incoming traffic must match the IP address and port of the outgoing connection.

**Anti-Spoof Checking:** Enable this feature to protect your network from certain kinds of “spoofing” attacks.

**Enable DMZ:** If an application has trouble working from behind the router, you can expose one computer to the Internet and run the application on that computer.

**Note:** Placing a computer in the DMZ may expose that computer to a variety of security risks. Use of this option is only recommended as a last resort.

**DMZ IP Address:** Specify the IP address of the computer on the LAN that you want to have unrestricted Internet communication. If this computer obtains its IP address automatically using DHCP, be sure to make a static reservation on the **Setup > Network Settings** page so that the IP address of the DMZ machine does not change.

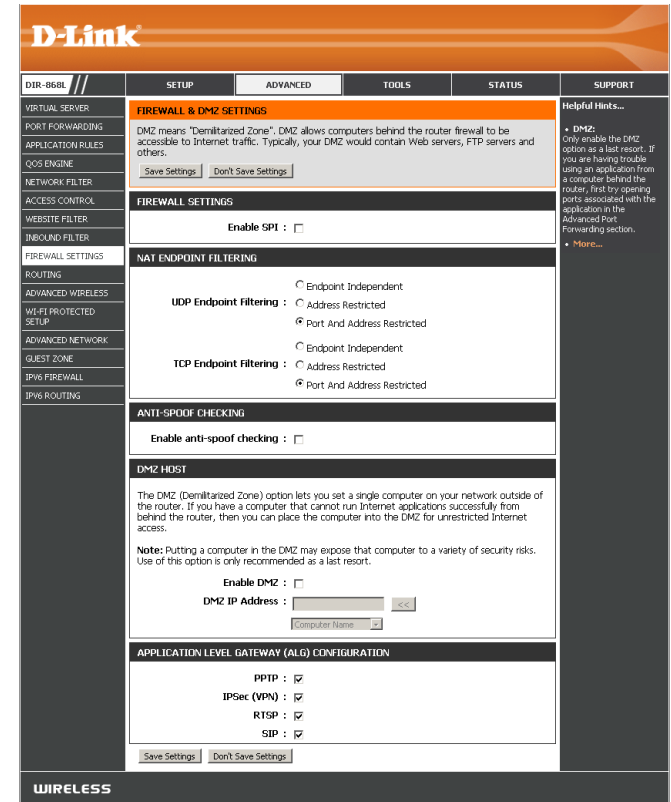

**PPTP:** Allows multiple machines on the LAN to connect to their corporate network using PPTP protocol.

**IPSec (VPN):** Allows multiple VPN clients to connect to their corporate network using IPSec. Some VPN clients support traversal of IPSec through NAT. This ALG may interfere with the operation of such VPN clients. If you are having trouble connecting with your corporate network, try turning this ALG off. Please check with the system administrator of your corporate network whether your VPN client supports NAT traversal.

**RTSP:** Allows application that uses Real Time Streaming Protocol to receive streaming media from the Internet. QuickTime and Real Player are some of the common applications using this protocol.

**SIP:** Allows devices and applications using VoIP (Voice over IP) to communicate across NAT. Some VoIP applications and devices have the ability to discover NAT devices and work around them. This ALG may interfere with the operation of such devices. If you are having trouble making VoIP calls, try turning this ALG off.

## Routing

The Routing option is an advanced method of customizing specific routes of data through your network.

**Name:** Enter a name for your route.

**Destination IP:** Enter the IP address of packets that will take this route.

**Netmask:** Enter the netmask of the route, please note that the octets must match your destination IP address.

**Gateway:** Enter your next hop gateway to be taken if this route is used.

**Metric:** The route metric is a value from 1 to 16 that indicates the cost of using this route. A value 1 is the lowest cost and 15 is the highest cost.

**Interface:** Select the interface that the IP packet must use to transit out of the router when this route is used.

The screenshot shows the D-Link DIR-868L web interface. The main content area is titled 'ROUTING' and contains the following text: 'The Routing option allows you to define static routes to specific destinations.' Below this text are two buttons: 'Save Settings' and 'Don't Save Settings'. Below the buttons is a section titled '32 -- ROUTE LIST' with the text 'Remaining number of rules that can be created: 32'. The 'ROUTE LIST' section contains a table with the following columns: 'Name', 'Destination IP', 'Metric', and 'Interface'. There are three rows of input fields for each column, each with a checkbox to its left. The 'Interface' column has a dropdown menu with 'WAN (10.10.10.100)' selected. The 'Helpful Hints...' sidebar on the right contains the following text: '• **Enable:** Specifies whether the entry will be enabled or disabled. • **Interface:** Specifies the interface -- WAN -- that the IP packet must use to transit out of the router, when this route is used. • **Destination IP:** The IP address of packets that will take this route. • **Netmask:** One bit in the mask specifies which bits of the IP address must match. • **Gateway:** The gateway IP address is the IP address of the router, if any, used to reach the specified destination. • **More...**

## Advanced Wireless

**Transmit Power:** Set the transmit power of the antennas.

**WLAN Partition:** This enables 802.11d operation. 802.11d is a wireless specification developed to allow implementation of wireless networks in countries that cannot use the 802.11 standard. This feature should only be enabled if you are in a country that requires it.

**WMM Enable:** WMM is QoS for your wireless network. This will improve the quality of video and voice applications for your wireless clients.

**HT20/40 Coexistence:** Enable this option to reduce interference from other wireless networks in your area. If the channel width is operating at 40MHz and there is another wireless network's channel over-lapping and causing interference, the router will automatically change to 20MHz.

The screenshot displays the D-Link DIR-868L Advanced Wireless Settings page. The page is divided into two main sections for 2.4GHz and 5GHz bands. Each section includes the following settings:

- Wireless Band:** 2.4GHz Band (top section) and 5GHz Band (bottom section).
- Transmit Power:** High (selected in both sections).
- WLAN Partition:**  (unchecked in both sections).
- WMM Enable:**  (checked in both sections).
- HT 20/40 Coexistence:**  Enable  Disable (selected as Enable in both sections).

The page also includes a 'Helpful Hints...' section on the right, which contains the following text:

- It is recommended that you leave these parameters with their default values. Adjusting them could limit the performance of your wireless network.
- Enabling WMM can help control latency and jitter when transmitting multimedia content over a wireless connection.
- [More...](#)

## Wi-Fi Protected Setup (WPS)

Wi-Fi Protected Setup (WPS) System is a simplified method for securing your wireless network during the “Initial setup” as well as the “Add New Device” processes. The Wi-Fi Alliance (WFA) has certified it across different products as well as manufactures. The process is just as easy as pressing a button for the Push-Button Method or correctly entering the 8-digit code for the Pin Code Method. The time reduction in setup and ease of use are quite beneficial, while the highest wireless Security setting of WPA2 is automatically used.

**Enable:** Enable the Wi-Fi Protected Setup feature.

**Note:** if this option is unchecked, the WPS button on the side of the router will be disabled.

**WiFi Protected Setup:** Displays the current WPS status.

**Lock WPS-PIN Setup:** Locking the WPS-PIN Method prevents the settings from being changed by any external registrar using its PIN. Devices can still be added to the wireless network using the Wi-Fi Protected Setup Push Button Configuration (WPS-PBC). It is still possible to change wireless networks settings with Manual Wireless Network Setup or Wireless Network Setup Wizard.

**PIN Settings:** A PIN is a unique number that can be used to add the router to an existing network or to create a new network. Only the Administrator (“admin” account) can change or reset the PIN.

**PIN:** Shows the current PIN.

**Reset PIN to Default:** Click to restore the default PIN of the router.

**Generate New PIN:** Create a random number that is a valid PIN. This becomes the router’s PIN. You can then copy this PIN to the user interface of the wireless client.

The screenshot displays the D-Link web interface for the DIR-868L router. The main navigation menu includes SETUP, ADVANCED, TOOLS, STATUS, and SUPPORT. The current page is 'WI-FI PROTECTED SETUP'. The left sidebar lists various configuration options, with 'WI-FI PROTECTED SETUP' selected. The main content area is divided into three sections:

- WI-FI PROTECTED SETUP:** Contains introductory text and two buttons: 'Save Settings' and 'Don't Save Settings'.
- WI-FI PROTECTED SETUP (Configuration):** Shows 'Enable' checked, 'WiFi Protected Setup : Enable/Configured', and 'Lock WPS-PIN Setup : [ ]'.
- PIN SETTINGS:** Displays the current PIN as '72479056' and includes 'Reset PIN to Default' and 'Generate New PIN' buttons.
- ADD WIRELESS STATION:** Features a 'Connect your Wireless Device' button and 'Save Settings'/'Don't Save Settings' buttons at the bottom.

A 'Helpful Hints...' sidebar on the right provides additional information:

- Enable if other wireless devices you wish to include in the local network support Wi-Fi Protected Setup.
- Only "Admin" account can change security settings.
- Lock WPS-PIN Setup Locking the WPS-PIN Method prevents the settings from being changed by any new external registrar using its PIN. Devices can still be added to the wireless network using Wi-Fi Protected Setup Push Button Configuration (WPS-PIN).
- Click Connect your Wireless Device to use Wi-Fi Protected Setup to add wireless devices to the wireless network.
- More...



**Add Wireless Station:** This Wizard helps you add wireless devices to the wireless network.

The wizard will either display the wireless network settings to guide you through manual configuration, prompt you to enter the PIN for the device, or ask you to press the configuration button on the device. If the device supports Wi-Fi Protected Setup and has a configuration button, you can add it to the network by pressing the configuration button on the device and then the on the router within 60 seconds. The status LED on the router will flash three times if the device has been successfully added to the network.

There are several ways to add a wireless device to your network. A “registrar” controls access to the wireless network. A registrar only allows devices onto the wireless network if you have entered the PIN, or pressed a special Wi-Fi Protected Setup button on the device. The router acts as a registrar for the network, although other devices may act as a registrar as well.

**Connect Your Wireless Device:** Click to start the wizard and skip to page 44.

## WPS Button

You can also simply press the WPS button on the back of the router, and then press the WPS button on your wireless client to automatically connect without logging into the router.

Refer to page 116 for more information.



## Advanced Network Settings

**Enable UPnP IGD:** To use the Universal Plug and Play (UPnP™) feature check the box. UPnP provides compatibility with networking equipment, software and peripherals.

**Enable WAN Ping Response:** Checking the box will allow the DIR-868L to respond to pings. Unchecking the box may provide some extra security from hackers.

**WAN Port Speed:** You may set the port speed of the Internet port to 10Mbps, 100Mbps, 1000Mbps, or Auto (recommended).

**Enable IPv4 Multicast Streams:** Check the box to allow multicast traffic to pass through the router from the Internet (IPv4).

**Enable IPv6 Multicast Streams:** Check the box to allow multicast traffic to pass through the router from the Internet (IPv6).

The screenshot displays the 'Advanced Network Settings' page for a D-Link DIR-868L router. The page is organized into several sections:

- ADVANCED NETWORK SETTINGS:** A warning message states that changing these settings may affect network behavior. There are 'Save Settings' and 'Don't Save Settings' buttons.
- UPNP:** A description of Universal Plug and Play (UPnP) is provided. The 'Enable UPnP IGD' checkbox is checked.
- WAN PING:** A description of the WAN Ping feature is provided. The 'Enable WAN Ping Response' checkbox is unchecked.
- WAN PORT SPEED:** The 'WAN Port Speed' is set to 'Auto' in a dropdown menu.
- IPV4 MULTICAST STREAMS:** The 'Enable IPv4 Multicast Streams' checkbox is unchecked.
- IPV6 MULTICAST STREAMS:** The 'Enable IPv6 Multicast Streams' checkbox is checked.

On the right side of the page, there is a 'Helpful Hints...' section with several bullet points providing additional information and warnings related to the settings.

## Guest Zone

The Guest Zone feature will allow you to create temporary zones that can be used by guests to access the Internet. These zones will be separate from your main wireless network. You may configure different zones for the 2.4GHz and 5GHz wireless bands.

**Enable Routing** Check to allow network connectivity between the **Between Zones:** different zones created.

**Enable Guest Zone:** Check to enable the Guest Zone feature.

**Schedule:** The schedule of time when the Guest Zone will be active. The schedule may be set to **Always**, which will allow the particular service to always be enabled. You can create your own times in the **Tools > Schedules** section or click **New Schedule**.

**Wireless Network Name:** Enter a wireless network name (SSID) that is different from your main wireless network.

**Security Mode:** Select the type of security or encryption you would like to enable for the guest zone.

The screenshot displays the D-Link DIR-868L web interface for configuring the Guest Zone. The interface is organized into a sidebar on the left with navigation tabs (SETUP, ADVANCED, TOOLS, STATUS, SUPPORT) and a main content area. The main content area is divided into sections for 2.4GHz and 5GHz wireless bands. Each section includes an 'Enable Guest Zone' checkbox, a schedule dropdown menu (set to 'Always'), and a 'New Schedule' button. The 2.4GHz section shows 'Wireless Band : 2.4GHz Band', 'Wireless Network Name : dlink-guest', and 'Security Mode : None'. The 5GHz section shows 'Wireless Band : 5GHz Band', 'Wireless Network Name : dlink-5GHz-guest', and 'Security Mode : None'. There are 'Save Settings' and 'Don't Save Settings' buttons at the bottom of each section. A 'Helpful Hints...' sidebar is visible on the right.

## IPv6 Firewall

The DIR-868L's IPv6 Firewall feature allows you to configure which kind of IPv6 traffic is allowed to pass through the device. The DIR-868L's IPv6 Firewall functions in a similar way to the IP Filters feature.

**Enable IPv6 Simple Security:** Check the box to enable the IPv6 firewall simple security.

**Configure IPv6 Filtering below:** Select an action from the drop-down menu.

**Name:** Enter a name to identify the IPv6 firewall rule.

**Schedule:** Use the drop-down menu to select the time schedule that the IPv6 Firewall Rule will be enabled on. The schedule may be set to **Always**, which will allow the particular service to always be enabled. You can create your own times in the **Tools > Schedules** section.

**Source:** Use the **Interface** drop-down menu to specify the interface that connects to the source IPv6 addresses of the firewall rule.

**IP Address Range:** Enter the source IPv6 address range in the adjacent **IP Address Range** field.

**Dest:** Use the **Interface** drop-down menu to specify the interface that connects to the destination IP addresses of the firewall rule.

**Protocol:** Select the protocol of the firewall port (**All**, **TCP**, **UDP**, or **ICMP**).

**Port Range:** Enter the first port of the range that will be used for the firewall rule in the first box and enter the last port in the field in the second box.

The screenshot shows the D-Link DIR-868L web interface. The top navigation bar includes 'SETUP', 'ADVANCED', 'TOOLS', 'STATUS', and 'SUPPORT'. The left sidebar lists various configuration options, with 'IPv6 FIREWALL' selected. The main content area is titled 'IPv6 FIREWALL' and contains the following sections:

- IPv6 FIREWALL:** A brief description of the feature and buttons for 'Save Settings' and 'Don't Save Settings'.
- IPv6 SIMPLE SECURITY:** A section with a checkbox labeled 'Enable IPv6 Simple Security'.
- 20 -- IPv6 FIREWALL RULES:** A section showing the remaining number of rules (20) and a dropdown menu to 'Configure IPv6 Filtering below' (set to 'Turn IPv6 Filtering OFF').
- Rule Configuration Form:** A form with the following fields:
  - Name:** A text input field.
  - Schedule:** A dropdown menu set to 'Always'.
  - Source:** A section with a checkbox, an 'Interface' dropdown, and an 'IP Address Range' input field.
  - Dest:** A section with a checkbox, an 'Interface' dropdown, an 'IP Address Range' input field, and a 'Port Range' input field.
  - Protocol:** A dropdown menu set to 'ALL'.

The right sidebar contains 'Helpful Hints...' with instructions on creating rules and schedules.

## IPv6 Routing

This page allows you to specify custom routes that determine how data is moved around your network.

**Route List:** Check the box next to the route you wish to enable.

**Name:** Enter a specific name to identify this route.

**Destination IP/ Prefix Length:** This is the IP address of the router used to reach the specified destination or enter the IPv6 address prefix length of the packets that will take this route.

**Metric:** Enter the metric value for this rule here.

**Interface:** Use the drop-down menu to specify if the IP packet must use the WAN or LAN interface to transit out of the Router.

**Gateway:** Enter the next hop that will be taken if this route is used.

**D-Link**

DIR-868L // SETUP ADVANCED TOOLS STATUS SUPPORT

**ROUTING**

This Routing page allows you to specify custom routes that determine how data is moved around your network.

Save Settings Don't Save Settings

**10 -- ROUTE LIST**

<input type="checkbox"/>	Name	Destination IPv6 / Prefix Length
		64
	Metric	Interface
		NULL
	Gateway	
<input type="checkbox"/>	Name	Destination IPv6 / Prefix Length
		64
	Metric	Interface
		NULL
	Gateway	
<input type="checkbox"/>	Name	Destination IPv6 / Prefix Length
		64
	Metric	Interface
		NULL
	Gateway	

**Helpful Hints...**

- Each route has a check box next to it, check this box if you want the route to be enabled.
- The name field allows you to specify a name for identification of this route, e.g. 'Network 2'.
- The destination IPv6 address is the address of the host or network you wish to reach.
- The prefix length field identifies the portion of the destination IP in use.
- The gateway IP address is the IP address of the router, if any, used to reach the specified destination.
- [More...](#)

# Tools Admin

This page will allow you to change the Administrator password and also enable Remote Management.

**Admin Password:** Enter a new password for the Administrator Login Name. Enter again to verify password. The administrator can make changes to the settings.

**Gateway Name:** Enter a name for your router.

**Enable Graphical Authentication:** Enables a challenge-response test to require users to type letters or numbers from a distorted image displayed on the screen to prevent online hackers and unauthorized users from gaining access to your router's network settings.

**Enable HTTPS Server:** Check to enable HTTPS to connect to the router securely. This means to connect to the router, you must enter **https://192.168.0.1** (for example) instead of **http://192.168.0.1**.

**Enable Remote Management:** Remote management allows the DIR-868L to be configured from the Internet by a web browser. A username/password is still required to access the Web Management interface.

**Remote Admin Port:** The port number used to access the DIR-868L is used in the URL. Example: **http://x.x.x.x:8080** whereas x.x.x.x is the Internet IP address of the DIR-868L and 8080 is the port used for the Web Management interface.

If you have enabled **HTTPS Server**, you must enter **https://** as part of the URL to access the router remotely.

**Remote Admin Inbound Filter:** This section will list any rules that are created. You may click the **Edit** icon to change the settings or enable/disable the rule, or click the **Delete** icon to remove the rule. **Details** will display the current remote admin filter.

The screenshot shows the D-Link DIR-868L Web Management interface. The top navigation bar includes 'DIR-868L //', 'SETUP', 'ADVANCED', 'TOOLS', 'STATUS', and 'SUPPORT'. The 'TOOLS' menu is selected, leading to the 'ADMIN' page. The page is titled 'ADMINISTRATOR SETTINGS' and contains the following sections:

- ADMINISTRATOR SETTINGS:** A text box explains that the 'admin' account can access the management interface and can change its password. It recommends creating a password to keep the router secure. There are 'Save Settings' and 'Don't Save Settings' buttons.
- ADMIN PASSWORD:** A section titled 'Please enter the same password into both boxes, for confirmation.' It contains two password input fields labeled 'Password' and 'Verify Password'.
- SYSTEM NAME:** A text box labeled 'Gateway Name' with the value 'DIR-868L' entered.
- ADMINISTRATION:** A section with several settings:
  - Enable Graphical Authentication:**
  - Enable HTTPS Server:**
  - Enable Remote Management:**
  - Remote Admin Port:** 8080, with a 'Use HTTPS:' checkbox.
  - Remote Admin Inbound Filter:** A dropdown menu set to 'Allow All'.
  - Details:** A text box set to 'Allow All'.

On the right side, there is a 'Helpful Hints...' sidebar with the following text:

- For security reasons, it is recommended that you change the password for the Admin account. Be sure to write down the new password to avoid having to reset the router in case they are forgotten.
- When enabling Remote Management, you can specify the IP address of the computer on the Internet that you want to have access to your router, or leave it blank to allow access to any computer on the Internet.
- Select a filter that controls access as needed for this admin port. If you do not see the filter you need in the list of filters, go to the **Advanced > Inbound Filter** screen and create a new filter.
- [More...](#)

At the bottom of the page, there is a 'WIRELESS' section.

## Time

The Time Configuration option allows you to configure, update, and maintain the correct time on the internal system clock. From this section you can set the time zone that you are in and set the Time Server. You have the option of using NTP, which is short for Network Time Protocol. An NTP server will sync the time and date with your router. Daylight Saving can also be configured to automatically adjust the time when needed.

**Time:** Displays the current date and time of the router.

**Time Zone:** Select your Time Zone from the drop-down menu.

**Enable Daylight Saving:** Check to enable manual entry of daylight saving time.

**Daylight Saving Offset:** When daylight saving manual entry is enabled, the offset value is one hour by default.

**Daylight Saving Dates:** Enter a start date, an end date, including day of the week, and time for daylight saving time.

**Automatically Synchronize with D-Link's Internet Time Server:** This option is strongly recommended. Check the box to have the router connect to an NTP server on the Internet (not a local server).

**NTP Server Used:** Select an NTP server from the drop-down box and click **Update Now**.

**Set the Time and Date Manually:** To manually input the time, enter the values in these fields for the *Year, Month, Day, Hour, Minute, and Second* and then click **Save Settings**.

You can also click **Sync. Your Computer's Time Settings** to synch the date and time with the computer you are currently on.

The screenshot shows the D-Link DIR-868L web interface. The top navigation bar includes 'D-Link', 'DIR-868L', and tabs for 'SETUP', 'ADVANCED', 'TOOLS', 'STATUS', and 'SUPPORT'. The left sidebar lists configuration options: ADMIN, TIME, SYSLOG, EMAIL SETTINGS, SYSTEM, FIRMWARE, DYNAMIC DNS, SYSTEM CHECK, and SCHEDULES. The main content area is titled 'TIME AND DATE' and contains the following sections:

- TIME AND DATE:** A header section with a description: 'The Time and Date Configuration option allows you to configure, update, and maintain the correct time on the internal system clock. From this section you can set the time zone you are in and set the NTP (Network Time Protocol) Server. Daylight Saving can also be configured to adjust the time when needed.' It includes 'Save Settings' and 'Don't Save Settings' buttons.
- TIME AND DATE CONFIGURATION:** A section showing the current time as '2013/04/04 12:11:33' and the time zone as '(GMT-08:00) Pacific Time (US & Canada, Tijuana)'. It includes checkboxes for 'Enable Daylight Saving' and 'Daylight Saving Offset' set to '+01:00'. Below are 'Daylight Saving Dates' with dropdowns for Month, Week, Day of Week, and Time for both DST Start and DST End.
- AUTOMATIC TIME AND DATE CONFIGURATION:** A section with a checked checkbox 'Automatically synchronize with D-Link's Internet time server'. It shows 'NTP Server Used' as 'ntp1.dlink.com' with an 'Update Now' button. A message states: 'The time has been successfully synchronized. (NTP Server Used: ntp1.dlink.com, Time: 2013/04/03 14:34:15) Next time synchronization: 2013/04/10 14:34:15'.
- SET THE TIME AND DATE MANUALLY:** A section with input fields for Year (2013), Month (Apr), Day (8), Hour (12), Minute (11), and Second (5). It includes a 'Sync. your computer's time settings' button and 'Save Settings'/'Don't Save Settings' buttons at the bottom.

On the right side, there is a 'Helpful Hints...' section with a tip: 'Either enter the time manually by clicking the **Sync. Your Computers Time Settings** button, or use the **Automatic Time Configuration** option to have your router synchronize with a time server on the Internet.' and a 'More...' link.

## SysLog

The DIR-868L keeps a running log of events and activities occurring on the Router. You may send these logs to a SysLog server on your network.

**Enable Logging to SysLog Server:** Check this box to send the router logs to a SysLog Server.

**SysLog Server IP Address:** The address of the SysLog server that will be used to send the logs. You may also select your computer from the drop-down menu (only if receiving an IP address from the router via DHCP).

The screenshot shows the D-Link DIR-868L web interface. The top navigation bar includes 'DIR-868L', 'SETUP', 'ADVANCED', 'TOOLS', 'STATUS', and 'SUPPORT'. The 'SYSLOG' page is active, displaying the following content:

- SYSLOG**: The SysLog options allow you to send log information to a Syslog Server.
  - Save Settings
  - Don't Save Settings
- SYSLOG SETTINGS**
  - Enable Logging To SysLog :  Server
  - Syslog Server IP Address :  << Computer Name
  - Save Settings
  - Don't Save Settings
- Helpful Hints...**
  - A System Logger (syslog) is a server that collects in one place the logs from different sources. If the LAN includes a syslog server, you can use this option to send the router's logs to that server.
  - [More...](#)

The bottom of the interface features a 'WIRELESS' banner.



## Email Settings

The Email feature can be used to send the system log files, router alert messages, and firmware update notification to your email address.

**Enable Email Notification:** When this option is enabled, router activity logs are emailed to a designated email address.

**From Email Address:** This email address will appear as the sender when you receive a log file or firmware upgrade notification via email.

**To Email Address:** Enter the email address where you want the email sent.

**Email Subject:** Add a subject line to your email.

**SMTP Server Address:** Enter the SMTP server address for sending email.

**SMTP Server Port:** Enter the SMTP port used on the server.

**Enable Authentication:** Check this box if your SMTP server requires authentication.

**Account Name:** Enter your account for sending email.

**Password:** Enter the password associated with the account. Re-type the password associated with the account.

**On Log Full:** When this option is selected, logs will be sent via email to your account when the log is full.

**On Schedule:** Selecting this option will send the logs via email according to schedule.

**Schedule:** This option is enabled when **On Schedule** is selected. You can select a schedule from the list of defined schedules. To create a schedule, go to **Tools > Schedules**.

**Detail:** Detail will display selected schedule.

The screenshot shows the D-Link DIR-868L web interface. The top navigation bar includes 'SETUP', 'ADVANCED', 'TOOLS', 'STATUS', and 'SUPPORT'. The left sidebar lists various configuration categories: ADMIN, TIME, SYSLOG, EMAIL SETTINGS (selected), SYSTEM, FIRMWARE, DYNAMIC DNS, SYSTEM CHECK, and SCHEDULES. The main content area is titled 'EMAIL SETTINGS' and contains the following sections:

- EMAIL SETTINGS:** A message stating 'The Email feature can be used to send the system log files and router alert messages to your email address.' with 'Save Settings' and 'Don't Save Settings' buttons.
- EMAIL NOTIFICATION:** A section with the option 'Enable Email Notification : .
- EMAIL SETTINGS:** A form with the following fields:
  - From Email Address :
  - To Email Address :
  - Email Subject :
  - SMTP Server Address :
  - SMTP Server Port :
  - Enable Authentication :
  - Account Name :
  - Password :
  - Verify Password :
- EMAIL LOG WHEN FULL OR ON SCHEDULE:** A section with the following options:
  - On Log Full :
  - On Schedule :
  - Schedule :
  - Detail :

At the bottom of the form are 'Save Settings' and 'Don't Save Settings' buttons. A 'Send Mail Now' button is located next to the Verify Password field. The footer of the page displays 'WIRELESS'.

## System

This section allows you to manage the router's configuration settings, reboot the router, and restore the router to the factory default settings. Restoring the unit to the factory default settings will erase all settings, including any rules that you've created.

**Save Settings to Local Hard Drive:** Use this option to save the current router configuration settings to a file on the hard disk of the computer you are using. First, click the **Save Configuration** button. A file dialog will appear, allowing you to select a location and file name for the settings.

**Load Settings from Local Hard Drive:** Use this option to load previously saved router configuration settings. First, use the **Choose File** option to find a previously saved file of configuration settings. Then, click the **Restore Configuration from File** button to transfer those settings to the router.

**Restore to Factory Default Settings:** This option will restore all configuration settings back to the settings that were in effect at the time the router was shipped from the factory. Any settings that have not been saved will be lost, including any rules that you have created. If you want to save the current router configuration settings, use the **Save Configuration** button above.

**Reboot the Device:** Click to reboot the router.

**Clear Language Pack:** Click **Clear** to remove any installed language packs.

The screenshot shows the D-Link DIR-868L web interface. The top navigation bar includes 'DIR-868L //', 'SETUP', 'ADVANCED', 'TOOLS', 'STATUS', and 'SUPPORT'. The left sidebar lists menu items: ADMIN, TIME, SYSLOG, EMAIL SETTINGS, SYSTEM, FIRMWARE, DYNAMIC DNS, SYSTEM CHECK, and SCHEDULES. The main content area is titled 'SAVE AND RESTORE SETTINGS' and contains the following options:

- Save Settings To Local Hard Drive :**
- Load Settings From Local Hard Drive :**  No file chosen
- Restore To Factory Default Settings :**
- Reboot The Device :**
- Clear Language Pack :**

The right sidebar, titled 'Helpful Hints...', contains the following text:

- Once your router is configured the way you want it, you can save these settings to a configuration file that can later be loaded in the event that the router's default settings are restored. To do this, click the **Save** button next to where it says Save Settings to Local Hard Drive.
- [More...](#)

The bottom of the interface features a 'WIRELESS' section.

## Firmware

You can upgrade the firmware of the router here. Make sure the firmware you want to use is on the local hard drive of the computer.

### Firmware Upgrade

**Choose File:** After you have downloaded the new firmware, click **Choose File** to locate the firmware update on your hard drive. Click **Upload** to complete the firmware upgrade.

**Upload:** Once you have a firmware update on your computer, use this option to browse for the file and then upload the information into the access point.

### Language Pack Upgrade

You can change the language of the web UI by uploading available language packs.

**Choose File:** After you have downloaded the new language pack, click **Choose File** to locate the language pack file on your hard drive. Click **Upload** to complete the language pack upgrade.

**Upload:** Once you have a language pack update on your computer, use this option to browse for the file and then upload the information into the access point.

The screenshot displays the D-Link DIR-868L web interface. The top navigation bar includes tabs for SETUP, ADVANCED, TOOLS, STATUS, and SUPPORT. The left sidebar lists various configuration options, with FIRMWARE selected. The main content area is titled 'FIRMWARE UPDATE' and contains the following sections:

- FIRMWARE UPDATE:** A notice stating that new firmware may be available to improve functionality and performance, with a link to check for updates. It provides instructions on how to upgrade the firmware and the language pack.
- FIRMWARE INFORMATION:** Displays the current firmware version (1.00) and time (01/28/2013 09:46:00). It includes a 'Check Online Now for Latest Firmware Version' button.
- FIRMWARE UPGRADE:** A section with a red warning: 'Note: Some firmware upgrades reset the configuration options to the factory defaults. Before performing an upgrade, be sure to save the current configuration.' It also includes instructions for upgrading the firmware and an 'Upload' button with a 'Choose File' option.
- LANGUAGE PACK UPGRADE:** A section for upgrading the language pack, also featuring an 'Upload' button with a 'Choose File' option.

The bottom of the interface shows the 'WIRELESS' section.

## Dynamic DNS

The Dynamic DNS (DDNS) feature allows you to host a server (Web, FTP, Game Server, etc...) using a domain name that you have purchased (www.whateveryournameis.com) with your dynamically assigned IP address. Most broadband Internet Service Providers assign dynamic (changing) IP addresses. Using a DDNS service provider, your friends can enter in your domain name to connect to your server no matter what your IP address is.

**Enable** Dynamic Domain Name System is a method of **Dynamic DNS:** keeping a domain name linked to a changing IP Address. Check the box to enable DDNS.

**Server Address:** Select your DDNS provider from the drop-down menu or enter the DDNS server address.

**Host Name:** Enter the Host Name that you registered with your DDNS service provider.

**Username or Key:** Enter the Username or key for your DDNS account.

**Password or Key:** Enter the Password or key for your DDNS account.

**Timeout:** Enter a timeout time (in hours).

**Status:** Displays the current connection status.

**D-Link**

DIR-868L // SETUP ADVANCED **TOOLS** STATUS SUPPORT

ADMIN  
TIME  
SYSLOG  
EMAIL SETTINGS  
SYSTEM  
FIRMWARE  
**DYNAMIC DNS**  
SYSTEM CHECK  
SCHEDULES

**DYNAMIC DNS**

The Dynamic DNS feature allows you to host a server (Web, FTP, Game Server, etc...) using a domain name that you have purchased (www.whateveryournameis.com) with your dynamically assigned IP address. Most broadband Internet Service Providers assign dynamic (changing) IP addresses. Using a DDNS service provider, your friends can enter your host name to connect to your game server no matter what your IP address is.

[Sign up for D-Link's Free DDNS service at www.DLinkDDNS.com.](http://www.DLinkDDNS.com)

Save Settings Don't Save Settings

**DYNAMIC DNS SETTINGS**

Enable Dynamic DNS :

Server Address :

Host Name :

Username or Key :

Password or Key :

Verify Password or Key :

Timeout : 567 (hours)

Status : Disconnected

**DYNAMIC DNS FOR IPV6 HOSTS**

Enable :

IPv6 Address :  << Computer Name

Host Name :  (e.g.: ipv6.mydomain.net)

Save Clear

**IPV6 DYNAMIC DNS LIST**

Enable	Host Name	IPv6 Address
<input type="checkbox"/>	<input type="text"/>	<input type="text"/>

Save Settings Don't Save Settings

**WIRELESS**

**Helpful Hints...**

- To use this Feature, you must first have a Dynamic DNS account from one of the providers in the drop down menu.
- We could also use DDNS function for IPv6 with the same account as IPv4.
- [More...](#)

### DDNS for IPv6 Hosts

**Enable:** Check the box to enable DDNS for IPv6 Hosts.

**IPv6 Address:** Enter the IPv6 address of your computer/server in your local network. You can click the << button and select a computer/server from the drop-down list.

**Host Name:** Enter the IPv6 Host Name that you registered with your DDNS service provider. Click **Save**.

**IPv6 DDNS List:** Once you save your entry, the IPv6 DDNS host information will be displayed here.

**Enable:** Check to enable the entry.

**Host Name:** Displays the name of your IPv6 DDNS host.

**IPv6 Address:** Displays the IPv6 address of your computer/server associated with the IPv6 DDNS host.

**Edit/Delete:** Click the edit icon to make changes to the entry or click the delete icon to remove the entry.



## System Check

**Ping Test:** The Ping Test is used to send Ping packets to test if a computer is on the Internet. Enter the IP address that you wish to Ping and click **Ping**.

**IPv6 Ping Test:** Enter the IPv6 address that you wish to Ping and click **Ping**.

**Ping Results:** The results of your ping attempts will be displayed here.

The screenshot shows the D-Link DIR-868L web interface. The top navigation bar includes tabs for SETUP, ADVANCED, TOOLS, STATUS, and SUPPORT. The left sidebar lists various configuration options: ADMIN, TIME, SYSLOG, EMAIL SETTINGS, SYSTEM, FIRMWARE, DYNAMIC DNS, SYSTEM CHECK, and SCHEDULES. The main content area is titled 'SYSTEM CHECK' and contains three sections: 'PING TEST', 'IPv6 PING TEST', and 'PING RESULT'. The 'PING TEST' section has a text input field for 'Host Name or IP Address' and a 'Ping' button. The 'IPv6 PING TEST' section has a text input field for 'Host Name or IPv6 Address' and a 'Ping' button. The 'PING RESULT' section contains the instruction 'Enter a host name or IP address above and click 'Ping''. On the right side, there is a 'Helpful Hints...' section with a bulleted list explaining the ping test and a 'More...' link. The bottom of the page features the 'WIRELESS' section header.

## Schedules

Schedules can be created for use with enforcing rules. For example, if you want to restrict web access to Mon-Fri from 3pm to 8pm, you could create a schedule selecting Mon, Tue, Wed, Thu, and Fri and enter a Start Time of 3pm and End Time of 8pm.

**Name:** Enter a name for your new schedule.

**Days:** Select a day, a range of days, or **All Week** to include every day of the week.

**Time:** Check **All Day - 24hrs** or enter a start and end time for your schedule.

**Add:** You must click **Add** to save your schedule rule.

**Schedule Rules** The list of schedules will be listed here. Click the **List:** **Edit** icon to make changes or click the **Delete** icon to remove the schedule.

**D-Link**

DIR-868L // SETUP ADVANCED TOOLS STATUS SUPPORT

ADMIN  
TIME  
SYSLOG  
EMAIL SETTINGS  
SYSTEM  
FIRMWARE  
DYNAMIC DNS  
SYSTEM CHECK  
SCHEDULES

**SCHEDULES**

The Schedule configuration option is used to manage schedule rules for "WAN", "Wireless", "Virtual Server", "Port Forwarding", "Applications" and "Network Filter".

**10 -- ADD SCHEDULE RULE**

Name :

Day(s) :  All Week  Select Day(s)  
 Sun  Mon  Tue  Wed  Thu  Fri  Sat

All Day - 24 hrs :

Time Format :   (hour:minute)

Start Time :  :   (hour:minute)

End Time :  :   (hour:minute)

**SCHEDULE RULES LIST**

Name	Day(s)	Time Frame

**Helpful Hints...**

- Schedules are used with a number of other features to define when those features are in effect.
- Give each schedule a name that is meaningful to you. For example, a schedule for Monday through Friday from 3:00pm to 9:00pm, might be called "After School".
- Click **Add** to add a completed schedule to the list below.
- Click **Edit** icon to change an existing schedule.
- Click **Delete** icon to permanently delete a schedule.
- [More...](#)

**WIRELESS**

# Status

## Device Info

This page displays the current information for the DIR-868L. It will display the LAN, WAN (Internet), and Wireless information. If your Internet connection is set up for a Dynamic IP address then a **Release** button and a **Renew** button will be displayed. Use **Release** to disconnect from your ISP and use **Renew** to connect to your ISP.

If your Internet connection is set up for PPPoE, a **Connect** button and a **Disconnect** button will be displayed. Use **Disconnect** to drop the PPPoE connection and use **Connect** to establish the PPPoE connection.

**General:** Displays the router's time and firmware version.

**WAN:** Displays the MAC address and the public IP settings.

**LAN:** Displays the MAC address and the private (local) IP settings for the router.

**Wireless LAN1:** Displays the 2.4GHz wireless MAC address and your wireless settings such as SSID and Channel.

**Wireless LAN2:** Displays the 5GHz wireless MAC address and your wireless settings such as SSID and Channel.

**LAN Computers:** Displays computers and devices that are connected to the router via Ethernet and that are receiving an IP address assigned by the router (DHCP).

**IGMP Multicast Memberships:** Displays IPv4 and IPv6 multicast group addresses.

The screenshot shows the D-Link DIR-868L web interface. The top navigation bar includes 'DIR-868L', 'SETUP', 'ADVANCED', 'TOOLS', 'STATUS', and 'SUPPORT'. The 'STATUS' tab is selected, and the 'DEVICE INFO' sub-tab is active. The page displays the following information:

- GENERAL:**
  - Time: 2013/04/04 12:39:09
  - Firmware Version: 1.00 Mon 28 Jan 2013
  - myDLINK Service: Non-Registered
- WAN:**
  - Connection Type: Dsl-Cable
  - Cable Status: Connected
  - Network Status: Connected
  - Connection Up Time: 0 Day 22 Hour 5 Min 12 Sec
  - MAC Address: c8d3-4322-8a13
  - IP Address: 10.10.10.100
  - Subnet Mask: 255.255.255.0
  - Default Gateway: 10.10.10.1
  - Primary DNS Server: 10.10.10.1
  - Secondary DNS Server: 0.0.0.0
- LAN:**
  - MAC Address: c8d3-4322-8a10
  - IP Address: 192.168.0.1
  - Subnet Mask: 255.255.255.0
  - DHCP Server: Enabled
- WIRELESS LAN1:**
  - Wireless Radio: Enabled
  - MAC Address: c8d3-4322-8a10
  - 802.11 Mode: Mixed 802.11n, 802.11g and 802.11b
  - Channel Width: 20/40MHz
  - Channel: 9
  - Network Name (SSID): dlink-8a10
  - Wi-Fi Protected Setup: Enabled/Configured
  - Security: WPA/WPA2-PSK
  - Guest Zone Wireless Radio: Disabled
  - Guest Zone Network Name: dlink-guest
  - Guest Zone (SSID): Disabled
  - Guest Zone Security: Disabled
- WIRELESS LAN2:**
  - Wireless Radio: Enabled
  - MAC Address: c8d3-4322-8a12
  - 802.11 Mode: Mixed 802.11n, 802.11n and 802.11a
  - Channel Width: 20/40/80MHz
  - Channel: 137
  - Network Name (SSID): dlink-5916-8a12
  - Wi-Fi Protected Setup: Enabled/Configured
  - Security: WPA/WPA2-PSK
  - Guest Zone Wireless Radio: Disabled
  - Guest Zone Network Name: dlink-5916-guest
  - Guest Zone (SSID): Disabled
  - Guest Zone Security: Disabled
- LAN COMPUTERS:**

MAC Address	IP Address	Name (if any)
00:19:99:2e:28:3c	192.168.0.105	GraphCast
- IGMP MULTICAST MEMBERSHIPS:**

IPv4 Multicast Group Address	IPv6 Multicast Group Address



## Logs

The router automatically logs (records) events of possible interest in its internal memory. If there isn't enough internal memory for all events, logs of older events are deleted but logs of the latest events are retained. The Logs option allows you to view the router logs. You can define what types of events you want to view and the level of the events to view. This router also has external Syslog Server support so you can send the log files to a computer on your network that is running a Syslog utility.

**Save Log File:** Click **Save** to save log file to local hard drive.

**Log Type & Level:** You can select the type and level indicating what you would like to keep track of.

**First Page:** Click to go to the first page.

**Last Page:** Click to go to the last page.

**Previous:** Click to go back one page.

**Next:** Click to go to the next page.

**Clear:** Clears all of the log contents.

**Link to Email Log Settings:** Clicking on this will take you to the **Tools > Email Settings** page.

The screenshot shows the D-Link DIR-868L web interface. The top navigation bar includes tabs for SETUP, ADVANCED, TOOLS, STATUS, and SUPPORT. The left sidebar lists various configuration categories like DEVICE INFO, LOGS, STATISTICS, etc. The main content area is titled 'VIEW LOG' and contains the following sections:

- VIEW LOG:** A message stating 'The View Log displays the activities occurring on the router.' with buttons for 'Save Settings' and 'Don't Save Settings'.
- SAVE LOG FILE:** A section with the text 'Save Log File To Local Hard Drive.' and a 'Save' button.
- LOG TYPE & LEVEL:** Radio buttons for Log Type (System, Firewall & Security, Router Status) and Log Level (Critical, Warning, Information).
- LOG FILES:** A table of log entries with columns for Time and Message. Navigation buttons (First Page, Last Page, Previous, Next, Clear, Link To Email Log Settings) are located above the table.

On the right side, there is a 'Helpful Hints...' section with several tips:

- Click on the Save button to save log file to local hard drive which can later send to the network administrator for troubleshooting. You can also select what type of event you would like to be logged from Log Type & Level.
- Check the log frequently to detect unauthorized network usage.
- You can also have the log mailed to you periodically. Refer to **Tools -> EMail**.
- [More...](#)

## Statistics

The screen below displays the **Traffic Statistics**. Here you can view the amount of packets that pass through the DIR-868L on both the WAN, LAN ports and the wireless segments. The traffic counter will reset if the device is rebooted.

**D-Link**

DIR-868L // SETUP ADVANCED TOOLS STATUS SUPPORT

DEVICES INFO  
LOGS  
**STATISTICS**  
INTERNET SESSIONS  
WIRELESS  
ROUTING  
IPv6  
IPv6 ROUTING

**TRAFFIC STATISTICS**  
Traffic Statistics displays Receive and Transmit packets passing through the device.  
[Refresh Statistics](#) [Reset Statistics](#)

**Helpful Hints...**

- This is a summary displaying the number of packets that have passed between the Internet and the LAN since the router was last initialized.
- [More...](#)

**LAN STATISTICS**

Sent :	10192	Received :	5686
TX Packets Dropped :	0	RX Packets Dropped :	0
Collisions :	0	Errors :	0

**WAN STATISTICS**

Sent :	373095	Received :	524150
TX Packets Dropped :	0	RX Packets Dropped :	0
Collisions :	0	Errors :	0

**WIRELESS STATISTICS - 2.4GHZ BAND**

Sent :	4112	Received :	12
TX Packets Dropped :	0	RX Packets Dropped :	0
Collisions :	0	Errors :	0

**WIRELESS STATISTICS - 5GHZ BAND**

Sent :	4092	Received :	0
TX Packets Dropped :	0	RX Packets Dropped :	0
Collisions :	0	Errors :	4

**WIRELESS**

## Internet Sessions

The Internet Sessions page displays full details of active Internet sessions through your router. An Internet session is a conversation between a program or application on a LAN-side computer and a program or application on a WAN-side computer.

**D-Link**

DIR-868L // SETUP ADVANCED TOOLS STATUS SUPPORT

DEVICE INFO  
LOGS  
STATISTICS  
**INTERNET SESSIONS**  
WIRELESS  
ROUTING  
IPv6  
IPv6 ROUTING

**INTERNET SESSIONS**

This page displays Source and Destination sessions passing through the device.

Refresh

IP	TCP Count	UDP Count
----	-----------	-----------

Helpful Hints...

- This is a list of all active conversations between WAN computers and LAN computers.
- [More...](#)

WIRELESS

## Wireless

The wireless client table displays a list of current connected wireless clients. This table also displays the connection rate and MAC address of the connected wireless clients.

DIR-868L //	SETUP	ADVANCED	TOOLS	STATUS	SUPPORT										
DEVICE INFO	<b>CONNECTED WIRELESS CLIENT LIST</b>				<b>Helpful Hints...</b> <ul style="list-style-type: none"> <li>This is a list of all wireless clients that are currently connected to your wireless router.</li> <li><a href="#">More...</a></li> </ul>										
LOGS	View the wireless clients that are connected to the router. (A client might linger in the list for a few minutes after an unexpected disconnect.)														
STATISTICS															
INTERNET SESSIONS	<b>NUMBER OF WIRELESS CLIENTS - 2.4GHZ BAND : 0</b>														
WIRELESS	<table border="1"> <thead> <tr> <th>MAC Address</th> <th>IP Address</th> <th>Mode</th> <th>Rate (Mbps)</th> <th>Signal (%)</th> </tr> </thead> <tbody> <tr> <td> </td> <td> </td> <td> </td> <td> </td> <td> </td> </tr> </tbody> </table>					MAC Address	IP Address	Mode	Rate (Mbps)	Signal (%)					
MAC Address	IP Address	Mode	Rate (Mbps)	Signal (%)											
ROUTING	<b>NUMBER OF WIRELESS CLIENTS - 5GHZ BAND : 0</b>														
IPv6	<table border="1"> <thead> <tr> <th>MAC Address</th> <th>IP Address</th> <th>Mode</th> <th>Rate (Mbps)</th> <th>Signal (%)</th> </tr> </thead> <tbody> <tr> <td> </td> <td> </td> <td> </td> <td> </td> <td> </td> </tr> </tbody> </table>					MAC Address	IP Address	Mode	Rate (Mbps)	Signal (%)					
MAC Address	IP Address	Mode	Rate (Mbps)	Signal (%)											
IPv6 ROUTING															
<b>WIRELESS</b>															

## Routing

This page will display your current routing table.

The screenshot shows the D-Link DIR-868L web interface. The top navigation bar includes the D-Link logo and tabs for SETUP, ADVANCED, TOOLS, STATUS, and SUPPORT. The left sidebar contains a menu with options: DEVICE INFO, LOGS, STATISTICS, INTERNET SESSIONS, WIRELESS, ROUTING (selected), IPv6, and IPv6 ROUTING. The main content area is titled "ROUTING" and contains a "Routing Table" section with the text: "This page displays the routing details configured for your router." Below this is a table with the following data:

Destination	Gateway	Genmask	Metric	Iface	Creator
192.168.7.0	0.0.0.0	255.255.255.0	0	LAN	SYSTEM
192.168.0.0	0.0.0.0	255.255.255.0	0	LAN	SYSTEM
10.10.10.0	0.0.0.0	255.255.255.0	0	INTERNET	SYSTEM
239.0.0.0	0.0.0.0	255.0.0.0	0	LAN	SYSTEM
0.0.0.0	10.10.10.1	255.255.255.255	100	INTERNET	SYSTEM

On the right side of the interface, there is a "Helpful Hints..." section with the following text:

- This is a list of all routing rules on router.
- [More...](#)

The bottom of the interface features a "WIRELESS" section header.

## IPv6

The IPv6 page displays a summary of the Router's IPv6 settings and lists the IPv6 address and host name of any IPv6 clients.

**D-Link**

DIR-868L // SETUP ADVANCED TOOLS STATUS SUPPORT

DEVICE INFO LOGS STATISTICS INTERNET SESSIONS WIRELESS ROUTING IPv6 IPv6 ROUTING

**IPv6 NETWORK INFORMATION**  
All of your IPv6 Internet and network connection details are displayed on this page.

**IPv6 CONNECTION INFORMATION**  
IPv6 Connection Type : Link-Local  
IPv6 Default Gateway : None  
LAN IPv6 Link-Local Address : fe80::cad3:a3ff:fe22:8a10 /64

**LAN IPv6 COMPUTERS**

IPv6 Address	Name(if any)
--------------	--------------

**WIRELESS**

**Helpful Hints...**  
• All of your WAN and LAN connection details are displayed here.  
• [More...](#)

## IPV6 Routing

This page displays the IPV6 routing details configured for your router.

The screenshot displays the D-Link web interface for the DIR-868L router. The top navigation bar includes the D-Link logo and tabs for SETUP, ADVANCED, TOOLS, STATUS, and SUPPORT. A left sidebar menu lists various configuration sections: DEVICE INFO, LOGS, STATISTICS, INTERNET SESSIONS, WIRELESS, ROUTING, IPv6, and IPV6 ROUTING. The main content area is titled "IPV6 ROUTING" and contains a message: "This page displays IPV6 routing details configured for your router." Below this is a section for the "IPV6 ROUTING TABLE" with a table structure. The table has four columns: Destination IP, Gateway, Metric, and Interface. The table is currently empty. To the right of the main content is a "Helpful Hints..." section with a bullet point: "This is a list of all IPv6 routing rules on router." and a link for "More...". The bottom of the interface features a "WIRELESS" section header.

Destination IP	Gateway	Metric	Interface
----------------	---------	--------	-----------

# Support

The screenshot displays the D-Link DIR-868L web interface. At the top, the D-Link logo is visible. Below it, a navigation bar contains tabs for SETUP, ADVANCED, TOOLS, STATUS, and SUPPORT. The SUPPORT tab is selected. On the left side, a vertical menu lists the main sections: MENU, SETUP, ADVANCED, TOOLS, and STATUS. The main content area is titled 'SUPPORT MENU' and contains four sub-sections: SETUP HELP, ADVANCED HELP, TOOLS HELP, and STATUS HELP. Each sub-section lists various help topics with blue hyperlinks.

DIR-868L //	SETUP	ADVANCED	TOOLS	STATUS	SUPPORT
MENU	<b>SUPPORT MENU</b>				
SETUP	<ul style="list-style-type: none"> <li>• <a href="#">Setup</a></li> <li>• <a href="#">Advanced</a></li> <li>• <a href="#">Tools</a></li> <li>• <a href="#">Status</a></li> </ul>				
ADVANCED	<b>SETUP HELP</b>				
TOOLS	<ul style="list-style-type: none"> <li>• <a href="#">Internet</a></li> <li>• <a href="#">Wireless Settings</a></li> <li>• <a href="#">Network Settings</a></li> <li>• <a href="#">Storage</a></li> <li>• <a href="#">Media Server</a></li> <li>• <a href="#">IPv6</a></li> <li>• <a href="#">MYDLINK SETTINGS</a></li> </ul>				
STATUS	<b>ADVANCED HELP</b>				
	<ul style="list-style-type: none"> <li>• <a href="#">Virtual Server</a></li> <li>• <a href="#">Port Forwarding</a></li> <li>• <a href="#">Application Rules</a></li> <li>• <a href="#">QoS Engine</a></li> <li>• <a href="#">Network Filter</a></li> <li>• <a href="#">Access Control</a></li> <li>• <a href="#">Website Filter</a></li> <li>• <a href="#">Inbound Filter</a></li> <li>• <a href="#">Firewall Settings</a></li> <li>• <a href="#">Routing</a></li> <li>• <a href="#">Advanced Wireless</a></li> <li>• <a href="#">Wi-Fi Protected Setup</a></li> <li>• <a href="#">Advanced Network</a></li> <li>• <a href="#">Guest Zone</a></li> <li>• <a href="#">IPv6 Firewall</a></li> <li>• <a href="#">IPv6 Routing</a></li> </ul>				
	<b>TOOLS HELP</b>				
	<ul style="list-style-type: none"> <li>• <a href="#">Device Administration</a></li> <li>• <a href="#">Time</a></li> <li>• <a href="#">Syslog</a></li> <li>• <a href="#">Email Settings</a></li> <li>• <a href="#">System</a></li> <li>• <a href="#">Firmware</a></li> <li>• <a href="#">Dynamic DNS</a></li> <li>• <a href="#">System Check</a></li> <li>• <a href="#">Schedules</a></li> </ul>				
	<b>STATUS HELP</b>				
	<ul style="list-style-type: none"> <li>• <a href="#">Device Info</a></li> <li>• <a href="#">Logs</a></li> <li>• <a href="#">Statistics</a></li> <li>• <a href="#">Internet Sessions</a></li> <li>• <a href="#">Wireless</a></li> <li>• <a href="#">Routing</a></li> <li>• <a href="#">IPv6</a></li> <li>• <a href="#">IPv6 Routing</a></li> </ul>				
<b>WIRELESS</b>					



# Connect a Wireless Client to your Router

## WPS Button

The easiest and most secure way to connect your wireless devices to the router is WPS (Wi-Fi Protected Setup). Most wireless devices such as wireless adapters, media players, Blu-ray DVD players, wireless printers and cameras will have a WPS button (or a software utility with WPS) that you can press to connect to the DIR-868L router. Please refer to your user manual for the wireless device you want to connect to make sure you understand how to enable WPS. Once you know, follow the steps below:

**Step 1** - Press the WPS button on the DIR-868L for about one second. The Internet LED on the front will start to blink.

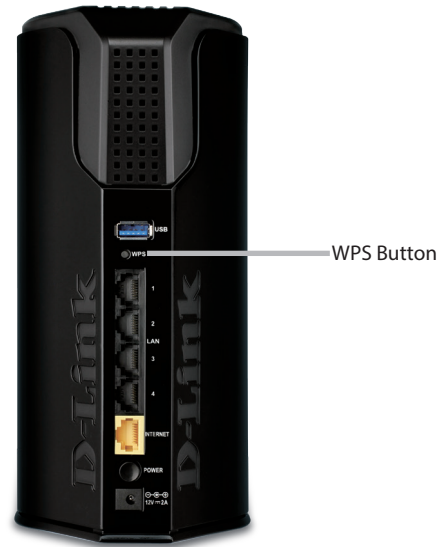

**Step 2** - Within two minutes, press the WPS button on your wireless client (or launch the software utility and start the WPS process).

**Step 3** - Allow up to one minute to configure. Once the Internet light stops blinking, you will be connected and your wireless connection will be secure with WPA2.

# Windows® 8

1. Click on the wireless computer icon in your system tray (lower-right corner next to the time).
2. A list of available wireless networks will appear.
3. Click the wireless network (SSID) you want to connect to and then click **Connect**.
4. If the network is secure/encrypted, enter the Wi-Fi password (security key) and click **Next**.

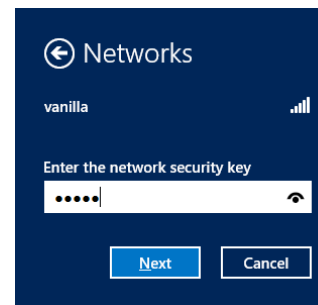
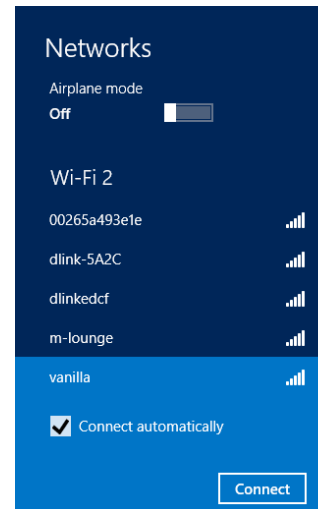
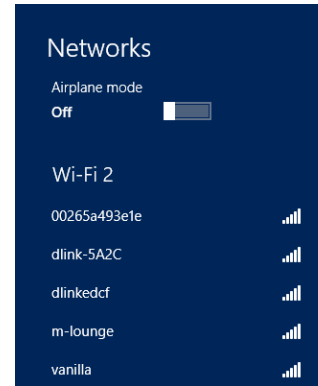

5. Click either to enable or disable file sharing.
6. You will now be connected to your wireless network.

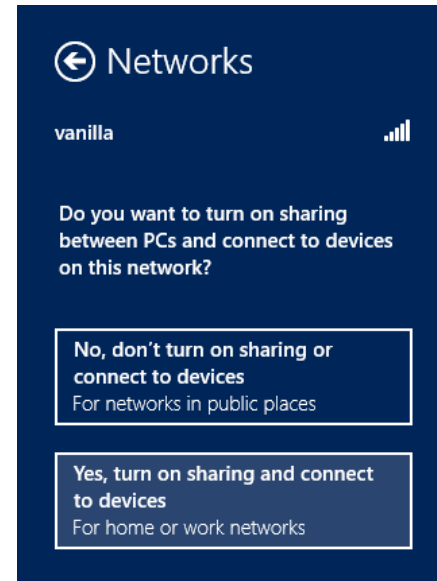

If you get a good signal but cannot access the Internet, confirm the encryption by reviewing the profile or check the TCP/IP settings for your wireless adapter. Refer to the *Networking Basics* section in this manual for more information.

# Windows® 7

## WPA/WPA2

It is recommended to enable wireless security (WPA/WPA2) on your wireless router or access point before configuring your wireless adapter. If you are joining an existing network, you will need to know the security key or passphrase being used.

1. Click on the wireless icon in your system tray (lower-right corner).

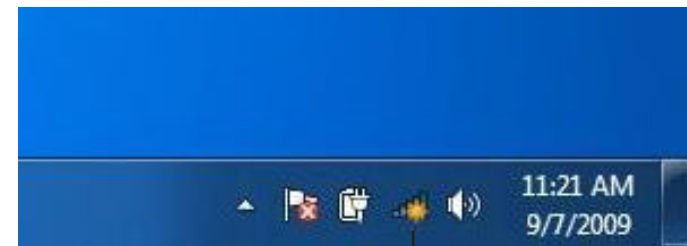

Wireless Icon

2. The utility will display any available wireless networks in your area.



3. Highlight the wireless network (SSID) you would like to connect to and click the **Connect** button.

If you get a good signal but cannot access the Internet, check your TCP/IP settings for your wireless adapter. Refer to the Networking Basics section in this manual for more information.



4. The following window appears while your computer tries to connect to the router.

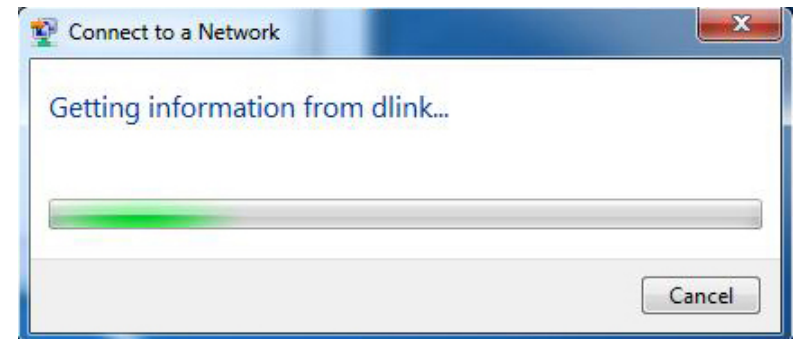

5. Enter the same security key or passphrase that is on your router and click **Connect**. You can also connect by pushing the WPS button on the router.

It may take 20-30 seconds to connect to the wireless network. If the connection fails, please verify that the security settings are correct. The key or passphrase must be exactly the same as on the wireless router.

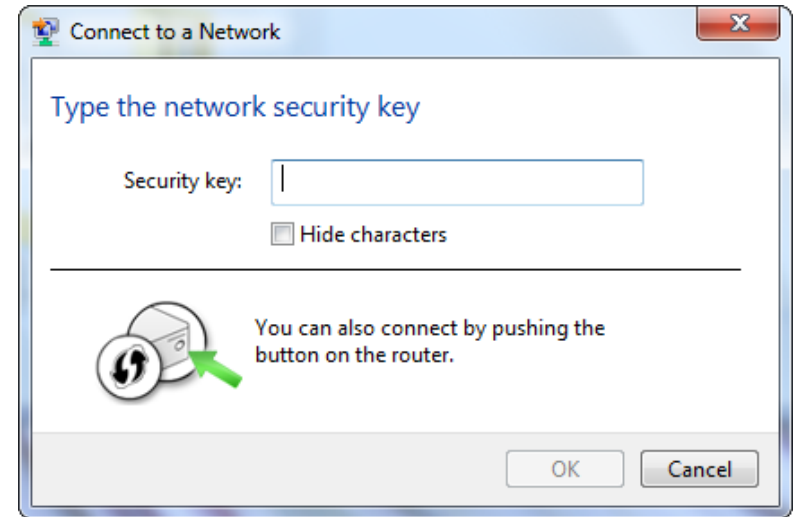

# WPS

The WPS feature of the DIR-868L can be configured using Windows® 7. Carry out the following steps to use Windows® 7 to configure the WPS feature:

1. Click the **Start** button and select **Computer** from the Start menu.

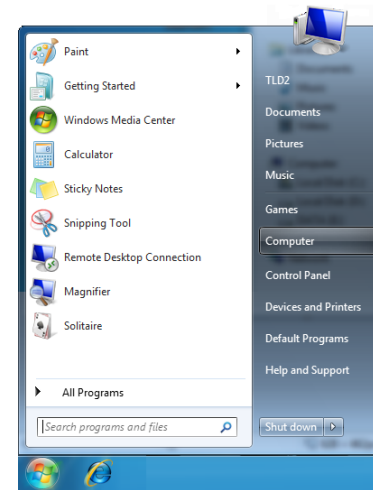

2. Click **Network** on the left side.

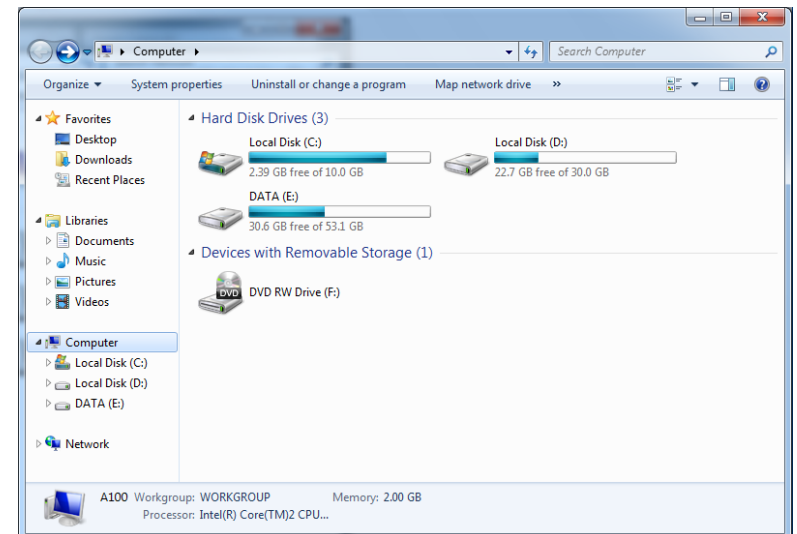

3. Double-click the DIR-868L.

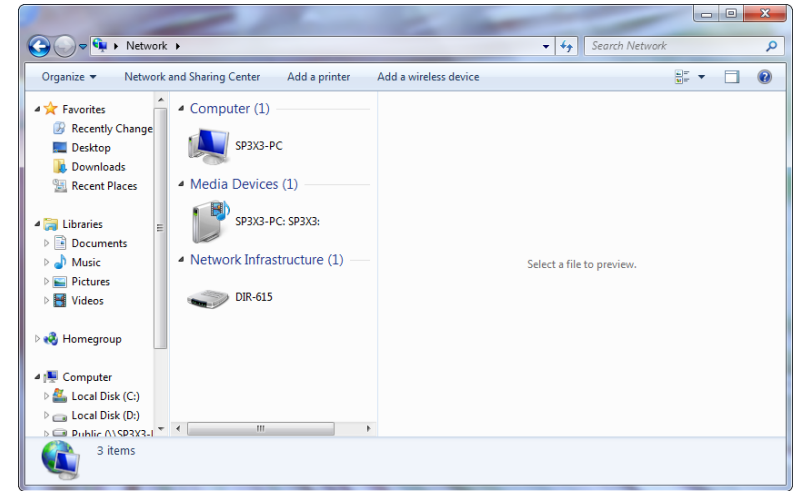

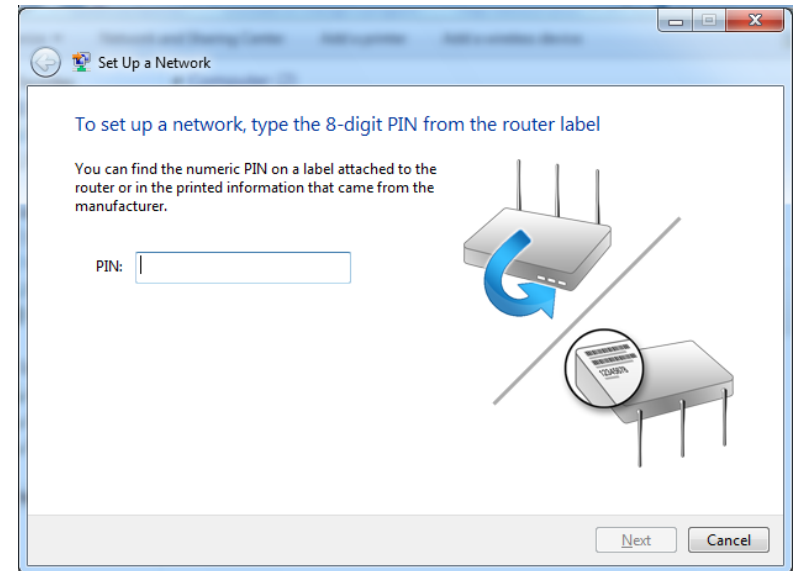

4. Input the WPS PIN number (displayed in the WPS window on the Router's LCD screen or in the **Setup** > **Wireless Setup** menu in the Router's Web UI) and click **Next**.



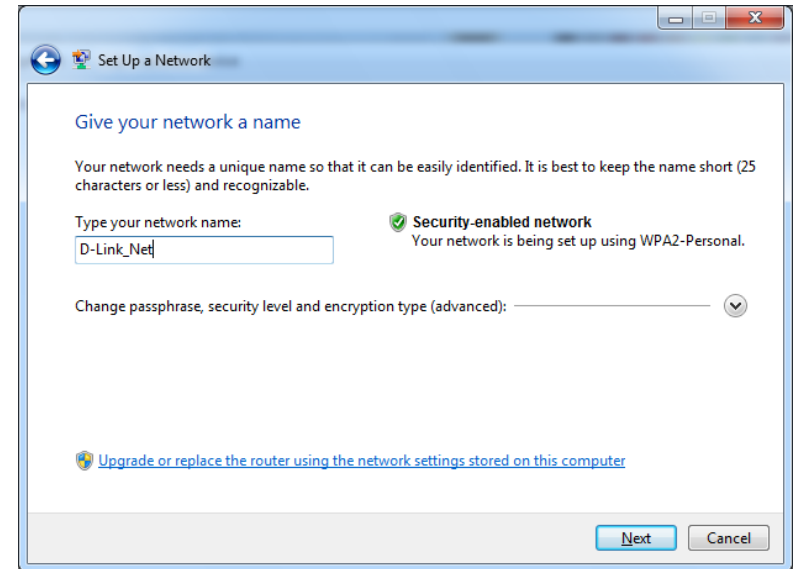

5. Type a name to identify the network.



6. To configure advanced settings, click the  icon.

Click **Next** to continue.

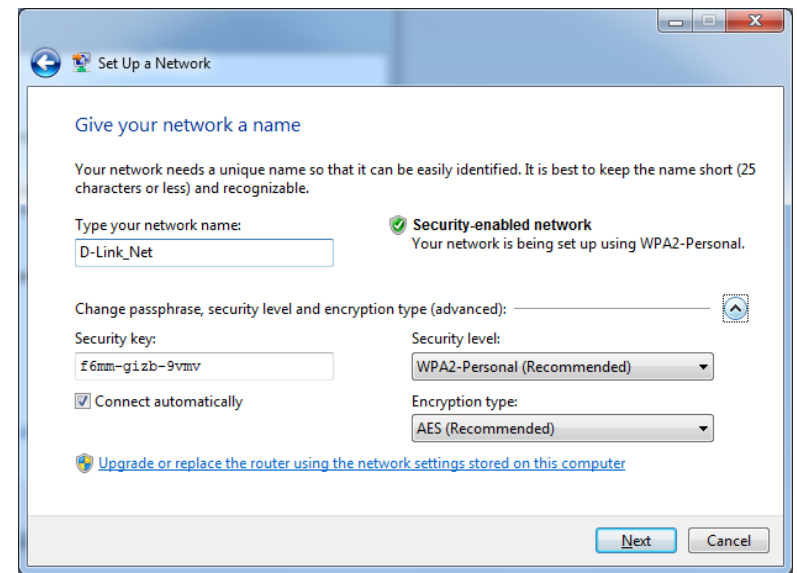

7. The following window appears while the Router is being configured.

Wait for the configuration to complete.

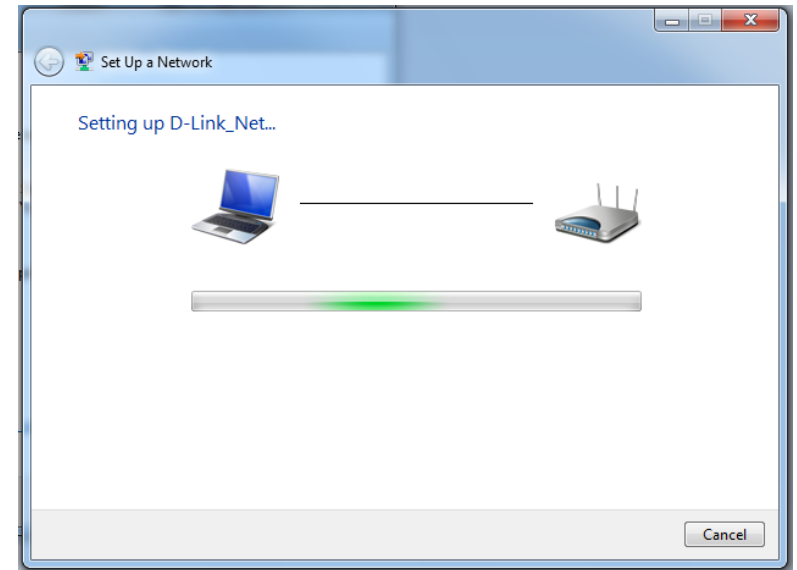

8. The following window informs you that WPS on the router has been setup successfully.

Make a note of the security key as you may need to provide this security key if adding an older wireless device to the network in the future.

9. Click **Close** to complete WPS setup.

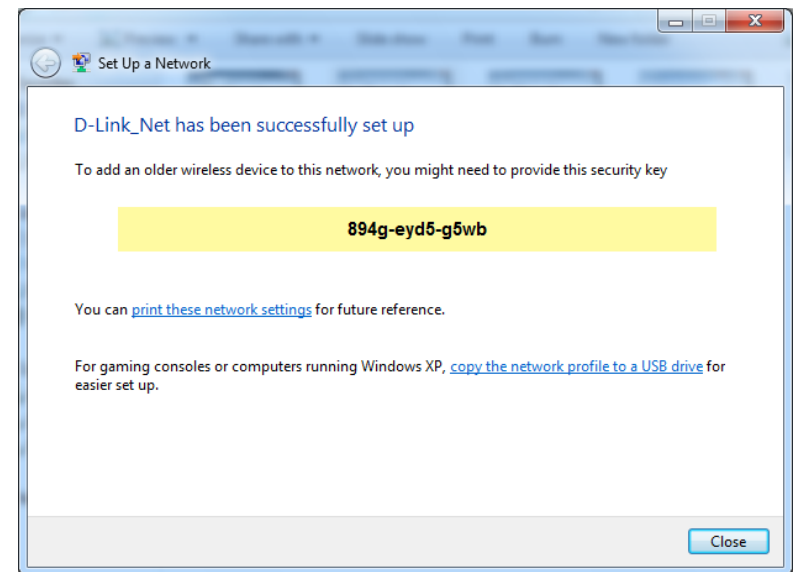

# Windows Vista®

Windows Vista® users may use the built-in wireless utility. If you are using another company's utility, please refer to the user manual of your wireless adapter for help with connecting to a wireless network. Most utilities will have a "site survey" option similar to the Windows Vista® utility as seen below.

If you receive the **Wireless Networks Detected** bubble, click on the center of the bubble to access the utility.

or

Right-click on the wireless computer icon in your system tray (lower-right corner next to the time). Select **Connect to a network**.



The utility will display any available wireless networks in your area. Click on a network (displayed using the SSID) and click the **Connect** button.

If you get a good signal but cannot access the Internet, check you TCP/IP settings for your wireless adapter. Refer to the **Networking Basics** section in this manual for more information.

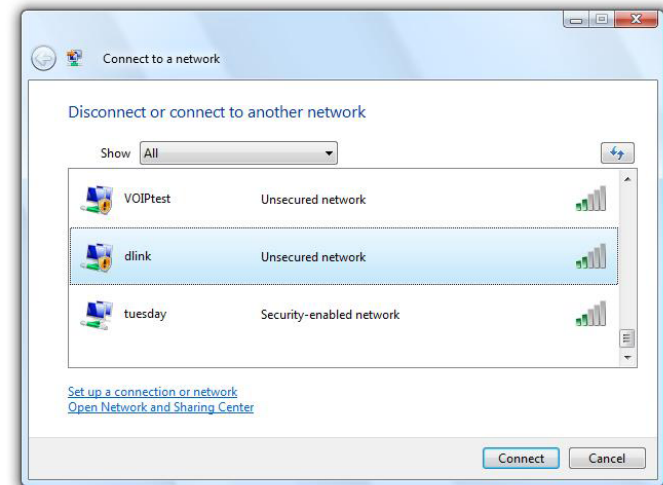

## WPA/WPA2

It is recommended to enable wireless security (WPA/WPA2) on your wireless router or access point before configuring your wireless adapter. If you are joining an existing network, you will need to know the security key or passphrase being used.

1. Open the Windows Vista® Wireless Utility by right-clicking on the wireless computer icon in your system tray (lower right corner of screen). Select **Connect to a network**.
2. Highlight the wireless network (SSID) you would like to connect to and click **Connect**.

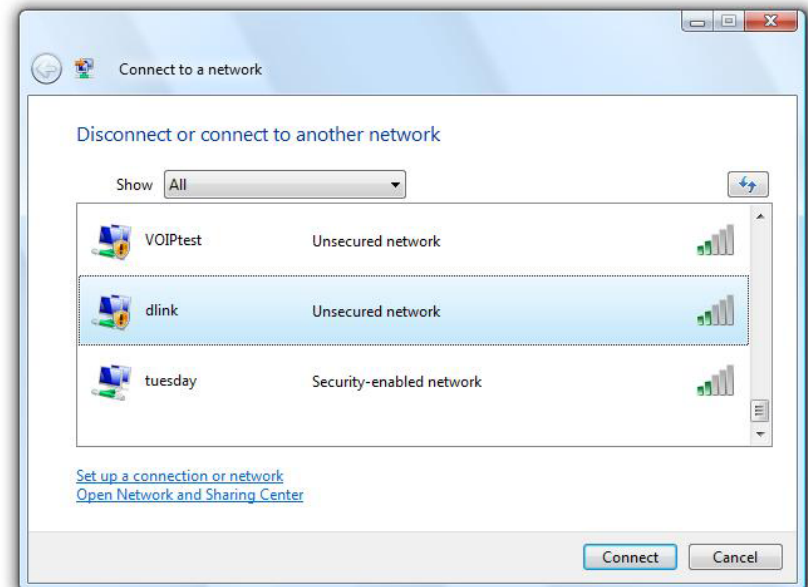
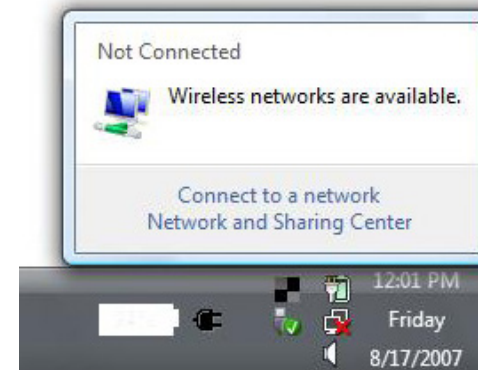

3. Enter the same security key or passphrase that is on your router and click **Connect**.

It may take 20-30 seconds to connect to the wireless network. If the connection fails, please verify that the security settings are correct. The key or passphrase must be exactly the same as on the wireless router.

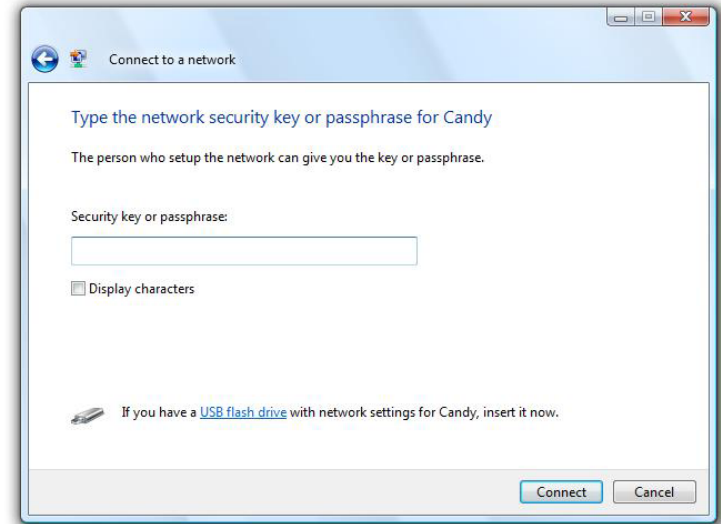

## WPS/WCN 2.0

The router supports Wi-Fi protection, referred to as WCN 2.0 in Windows Vista®. The following instructions for setting this up depends on whether you are using Windows Vista® to configure the router or third party software.

When you first set up the router, Wi-Fi protection is disabled and unconfigured. To enjoy the benefits of Wi-Fi protection, the router must be both enabled and configured. There are three basic methods to accomplish this: use Windows Vista's built-in support for WCN 2.0, use software provided by a third party, or manually configure.

If you are running Windows Vista®, log into the router and click the **Enable** checkbox in the **Basic > Wireless** section. Use the Current PIN that is displayed on the **Advanced > Wi-Fi Protected Setup** section or choose to click the **Generate New PIN** button or **Reset PIN to Default** button.

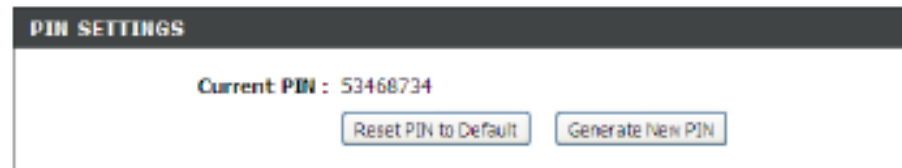

If you are using third party software to set up Wi-Fi Protection, carefully follow the directions. When you are finished, proceed to the next section to set up the newly-configured router.

# Windows® XP

Windows® XP users may use the built-in wireless utility (Zero Configuration Utility). If you are using another company's utility, please refer to the user manual of your wireless adapter for help with connecting to a wireless network. Most utilities will have a "site survey" option similar to the Windows® XP utility as seen below.

If you receive the **Wireless Networks Detected** bubble, click on the center of the bubble to access the utility.

or

Right-click on the wireless computer icon in your system tray (lower-right corner next to the time). Select **View Available Wireless Networks**.

The utility will display any available wireless networks in your area. Click on a network (displayed using the SSID) and click the **Connect** button.

If you get a good signal but cannot access the Internet, check you TCP/IP settings for your wireless adapter. Refer to the **Networking Basics** section in this manual for more information.

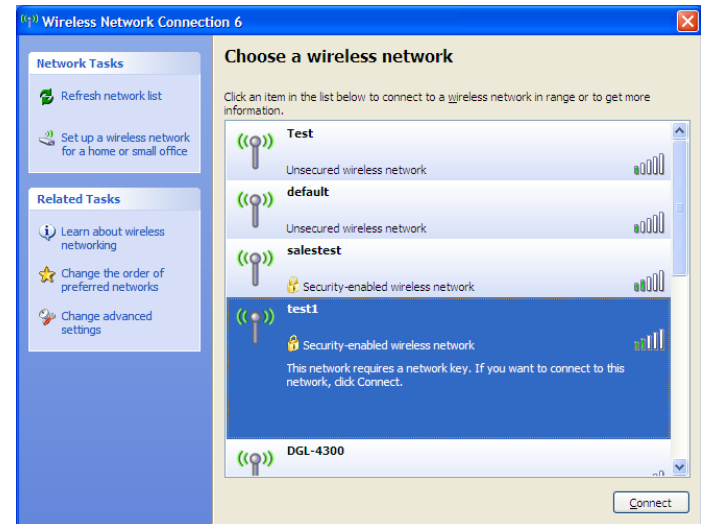
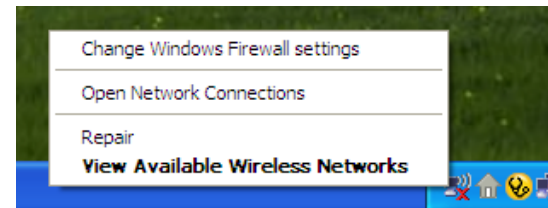
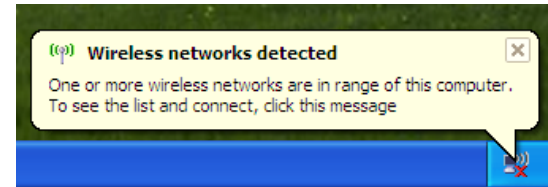

## WPA/WPA2

It is recommended to enable WPA on your wireless router or access point before configuring your wireless adapter. If you are joining an existing network, you will need to know the WPA key being used.

1. Open the Windows® XP Wireless Utility by right-clicking on the wireless computer icon in your system tray (lower-right corner of screen). Select **View Available Wireless Networks**.

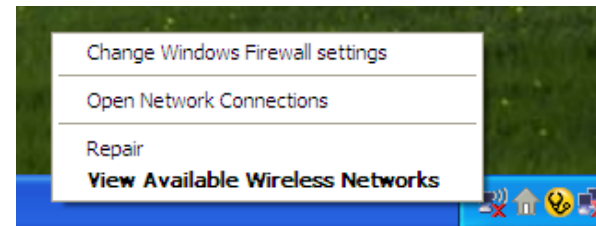

2. Highlight the wireless network (SSID) you would like to connect to and click **Connect**.

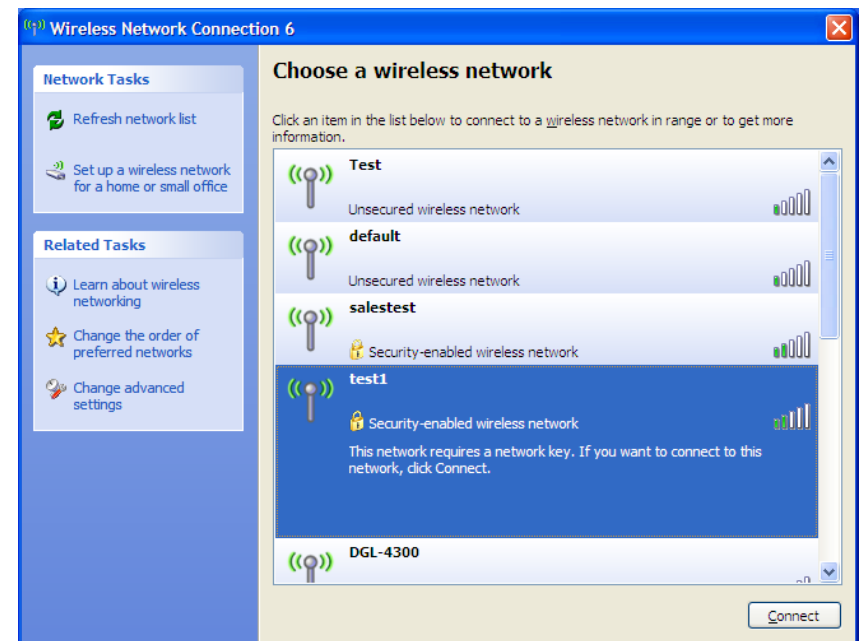



3. The **Wireless Network Connection** box will appear. Enter the WPA-PSK passphrase and click **Connect**.

It may take 20-30 seconds to connect to the wireless network. If the connection fails, please verify that the WPA-PSK settings are correct. The WPA-PSK passphrase must be exactly the same as on the wireless router.

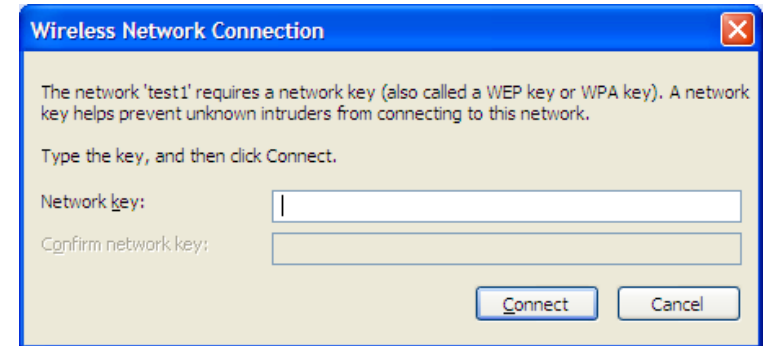

# Troubleshooting

This chapter provides solutions to problems that can occur during the installation and operation of the DIR-868L. Read the following descriptions if you are having problems. The examples below are illustrated in Windows® XP. If you have a different operating system, the screenshots on your computer will look similar to the following examples.

## 1. Why can't I access the web-based configuration utility?

When entering the IP address of the D-Link router (192.168.0.1 for example), you are not connecting to a website nor do you have to be connected to the Internet. The device has the utility built-in to a ROM chip in the device itself. Your computer must be on the same IP subnet to connect to the web-based utility.

- Make sure you have an updated Java-enabled web browser. We recommend the following:
  - Microsoft Internet Explorer® 7 and higher
  - Mozilla Firefox 3.5 and higher
  - Google™ Chrome 8 and higher
  - Apple Safari 4 and higher
- Verify physical connectivity by checking for solid link lights on the device. If you do not get a solid link light, try using a different cable or connect to a different port on the device if possible. If the computer is turned off, the link light may not be on.
- Disable any Internet security software running on the computer. Software firewalls such as Zone Alarm, Black Ice, Sygate, Norton Personal Firewall, and Windows® XP firewall may block access to the configuration pages. Check the help files included with your firewall software for more information on disabling or configuring it.

- Configure your Internet settings:
  - Go to **Start > Settings > Control Panel**. Double-click the **Internet Options** icon. From the **Security** tab, click the button to restore the settings to their defaults.
  - Click the **Connection** tab and set the dial-up option to Never Dial a Connection. Click the LAN Settings button. Make sure nothing is checked. Click **OK**.
  - Go to the **Advanced** tab and click the button to restore these settings to their defaults. Click **OK** three times.
  - Close your web browser (if open) and open it.
- Access the web management. Open your web browser and enter the IP address of your D-Link router in the address bar. This should open the login page for your web management.
- If you still cannot access the configuration, unplug the power to the router for 10 seconds and plug back in. Wait about 30 seconds and try accessing the configuration. If you have multiple computers, try connecting using a different computer.

## 2. What can I do if I forgot my password?

If you forgot your password, you must reset your router. Unfortunately this process will change all your settings back to the factory defaults.

To reset the router, locate the reset button (hole) on the bottom of the unit. With the router powered on, use a paperclip to hold the button down for 10 seconds. Release the button and the router will go through its reboot process. Wait about 30 seconds to access the router. To re-configure the router, refer to page 13.



### 3. Why can't I connect to certain sites or send and receive e-mails when connecting through my router?

If you are having a problem sending or receiving e-mail, or connecting to secure sites such as eBay, banking sites, and Hotmail, we suggest lowering the MTU in increments of ten (Ex. 1492, 1482, 1472, etc).

To find the proper MTU Size, you'll have to do a special ping of the destination you're trying to go to. A destination could be another computer, or a URL.

- Click on **Start** and then click **Run**.
- Windows® 95, 98, and Me users type in **command** (Windows® NT, 2000, XP, Vista®, and 7 users type in **cmd**) and press **Enter** (or click **OK**).
- Once the window opens, you'll need to do a special ping. Use the following syntax:

**ping [url] [-f] [-l] [MTU value]**

Example: **ping yahoo.com -f -l 1472**

```
C:\>ping yahoo.com -f -l 1482
Pinging yahoo.com [66.94.234.13] with 1482 bytes of data:
Packet needs to be fragmented but DF set.
Packet needs to be fragmented but DF set.
Packet needs to be fragmented but DF set.
Packet needs to be fragmented but DF set.
Ping statistics for 66.94.234.13:
    Packets: Sent = 4, Received = 0, Lost = 4 (100% loss),
    Approximate round trip times in milli-seconds:
        Minimum = 0ms, Maximum = 0ms, Average = 0ms
C:\>ping yahoo.com -f -l 1472
Pinging yahoo.com [66.94.234.13] with 1472 bytes of data:
Reply from 66.94.234.13: bytes=1472 time=93ms TTL=52
Reply from 66.94.234.13: bytes=1472 time=109ms TTL=52
Reply from 66.94.234.13: bytes=1472 time=125ms TTL=52
Reply from 66.94.234.13: bytes=1472 time=203ms TTL=52
Ping statistics for 66.94.234.13:
    Packets: Sent = 4, Received = 4, Lost = 0 (0% loss),
    Approximate round trip times in milli-seconds:
        Minimum = 93ms, Maximum = 203ms, Average = 132ms
C:\>
```

You should start at 1472 and work your way down by 10 each time. Once you get a reply, go up by 2 until you get a fragmented packet. Take that value and add 28 to the value to account for the various TCP/IP headers. For example, let's say that 1452 was the proper value, the actual MTU size would be 1480, which is the optimum for the network we're working with ( $1452+28=1480$ ).

Once you find your MTU, you can now configure your router with the proper MTU size.

To change the MTU rate on your router follow the steps below:

- Open your browser, enter the IP address of your router (192.168.0.1) and click **OK**.
- Enter your username (admin) and password (blank by default). Click **OK** to enter the web configuration page for the device.
- Click on **Setup** and then click **Manual Configure**.
- To change the MTU enter the number in the MTU field and click **Save Settings** to save your settings.
- Test your e-mail. If changing the MTU does not resolve the problem, continue changing the MTU in increments of ten.

# Wireless Basics

D-Link wireless products are based on industry standards to provide easy-to-use and compatible high-speed wireless connectivity within your home, business or public access wireless networks. Strictly adhering to the IEEE standard, the D-Link wireless family of products will allow you to securely access the data you want, when and where you want it. You will be able to enjoy the freedom that wireless networking delivers.

A wireless local area network (WLAN) is a cellular computer network that transmits and receives data with radio signals instead of wires. Wireless LANs are used increasingly in both home and office environments, and public areas such as airports, coffee shops and universities. Innovative ways to utilize WLAN technology are helping people to work and communicate more efficiently. Increased mobility and the absence of cabling and other fixed infrastructure have proven to be beneficial for many users.

Wireless users can use the same applications they use on a wired network. Wireless adapter cards used on laptop and desktop systems support the same protocols as Ethernet adapter cards.

Under many circumstances, it may be desirable for mobile network devices to link to a conventional Ethernet LAN in order to use servers, printers or an Internet connection supplied through the wired LAN. A Wireless Router is a device used to provide this link.

## **What is Wireless?**

Wireless or Wi-Fi technology is another way of connecting your computer to the network without using wires. Wi-Fi uses radio frequency to connect wirelessly, so you have the freedom to connect computers anywhere in your home or office network.

## **Why D-Link Wireless?**

D-Link is the worldwide leader and award winning designer, developer, and manufacturer of networking products. D-Link delivers the performance you need at a price you can afford. D-Link has all the products you need to build your network.

## **How does wireless work?**

Wireless works similar to how cordless phones work, through radio signals to transmit data from one point A to point B. But wireless technology has restrictions as to how you can access the network. You must be within the wireless network range area to be able to connect your computer. There are two different types of wireless networks Wireless Local Area Network (WLAN), and Wireless Personal Area Network (WPAN).

### **Wireless Local Area Network (WLAN)**

In a wireless local area network, a device called an Access Point (AP) connects computers to the network. The access point has a small antenna attached to it, which allows it to transmit data back and forth over radio signals. With an indoor access point, the signal can travel up to 300 feet. With an outdoor access point the signal can reach out up to 30 miles to serve places like manufacturing plants, industrial locations, college and high school campuses, airports, golf courses, and many other outdoor venues.

## **Wireless Personal Area Network (WPAN)**

Bluetooth is the industry standard wireless technology used for WPAN. Bluetooth devices in WPAN operate in a range up to 30 feet away.

Compared to WLAN the speed and wireless operation range are both less than WLAN, but in return it doesn't use nearly as much power which makes it ideal for personal devices, such as mobile phones, PDAs, headphones, laptops, speakers, and other devices that operate on batteries.

## **Who uses wireless?**

Wireless technology has become so popular in recent years that almost everyone is using it, whether it's for home, office, business, D-Link has a wireless solution for it.

### **Home**

- Gives everyone at home broadband access
- Surf the web, check email, instant message, etc.
- Gets rid of the cables around the house
- Simple and easy to use

### **Small Office and Home Office**

- Stay on top of everything at home as you would at office
- Remotely access your office network from home
- Share Internet connection and printer with multiple computers
- No need to dedicate office space



## **Where is wireless used?**

Wireless technology is expanding everywhere not just at home or office. People like the freedom of mobility and it's becoming so popular that more and more public facilities now provide wireless access to attract people. The wireless connection in public places is usually called "hotspots".

Using a D-Link Cardbus Adapter with your laptop, you can access the hotspot to connect to Internet from remote locations like: Airports, Hotels, Coffee Shops, Libraries, Restaurants, and Convention Centers.

Wireless network is easy to setup, but if you're installing it for the first time it could be quite a task not knowing where to start. That's why we've put together a few setup steps and tips to help you through the process of setting up a wireless network.

## **Tips**

Here are a few things to keep in mind, when you install a wireless network.

### **Centralize your router or Access Point**

Make sure you place the router/access point in a centralized location within your network for the best performance. Try to place the router/access point as high as possible in the room, so the signal gets dispersed throughout your home. If you have a two-story home, you may need a repeater to boost the signal to extend the range.

### **Eliminate Interference**

Place home appliances such as cordless telephones, microwaves, and televisions as far away as possible from the router/access point. This would significantly reduce any interference that the appliances might cause since they operate on same frequency.

## Security

Don't let your next-door neighbors or intruders connect to your wireless network. Secure your wireless network by turning on the WPA or WEP security feature on the router. Refer to product manual for detail information on how to set it up.

# Wireless Modes

There are basically two modes of networking:

- **Infrastructure** – All wireless clients will connect to an access point or wireless router.
- **Ad-Hoc** – Directly connecting to another computer, for peer-to-peer communication, using wireless network adapters on each computer, such as two or more DIR-868L wireless network Cardbus adapters.

An Infrastructure network contains an Access Point or wireless router. All the wireless devices, or clients, will connect to the wireless router or access point.

An Ad-Hoc network contains only clients, such as laptops with wireless cardbus adapters. All the adapters must be in Ad-Hoc mode to communicate.

# Networking Basics

## Check your IP address

After you install your new D-Link wireless adapter and have established a wireless connection, by default, the TCP/IP settings should be set to obtain an IP address from a DHCP server (i.e., router) automatically. To verify your IP address, please follow the steps below.

### Windows® 8 Users

- Press the **Windows key** and **R** together. Type **cmd** in the box and click **OK**.
- At the prompt, type **ipconfig** and press **Enter**.
- This will display the IP address, subnet mask, and default gateway of your adapter.

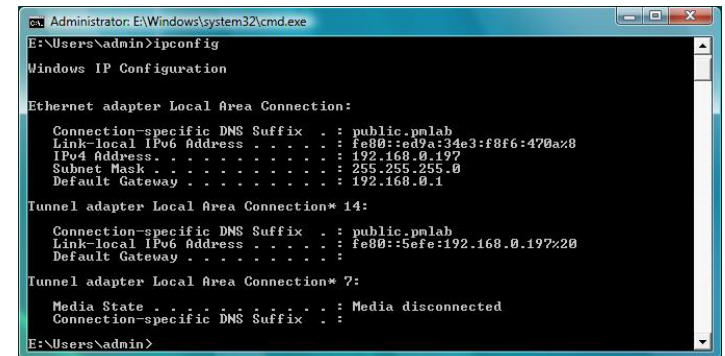

```
Administrator: E:\Windows\system32\cmd.exe
E:\Users\Admin>ipconfig

Windows IP Configuration

Ethernet adapter Local Area Connection:

    Connection-specific DNS Suffix  . : public.pmlab
    Link-local IPv6 Address . . . . . : fe80::ed9a:34e3:f8f6:470a%8
    IPv4 Address. . . . . : 192.168.0.197
    Subnet Mask . . . . . : 255.255.255.0
    Default Gateway . . . . . : 192.168.0.1

Tunnel adapter Local Area Connection* 14:

    Connection-specific DNS Suffix  . : public.pmlab
    Link-local IPv6 Address . . . . . : fe80::5efe:192.168.0.197%20
    Default Gateway . . . . . :

Tunnel adapter Local Area Connection* 7:

    Media State . . . . . : Media disconnected
    Connection-specific DNS Suffix  . :

E:\Users\Admin>
```

### Windows® 7/Vista® Users

- Click **Start**, type **cmd** in the search box and then click **OK**.
- At the prompt, type **ipconfig** and press **Enter**.
- This will display the IP address, subnet mask, and default gateway of your adapter.

### Windows® XP Users

- Click on **Start > Run**. In the run box type **cmd** and click **OK**.
- At the prompt, type **ipconfig** and press **Enter**.
- This will display the IP address, subnet mask, and the default gateway of your adapter.

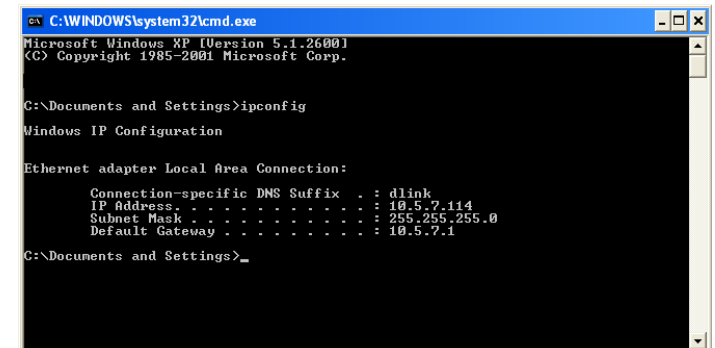

```
C:\WINDOWS\system32\cmd.exe
Microsoft Windows XP [Version 5.1.2600]
(C) Copyright 1985-2001 Microsoft Corp.

C:\Documents and Settings>ipconfig

Windows IP Configuration

Ethernet adapter Local Area Connection:

    Connection-specific DNS Suffix  . : dlink
    IP Address. . . . . : 10.5.7.114
    Subnet Mask . . . . . : 255.255.255.0
    Default Gateway . . . . . : 10.5.7.1

C:\Documents and Settings>_
```

If the address is 0.0.0.0, check your adapter installation, security settings, and the settings on your router. Some firewall software programs may block a DHCP request on newly installed adapters.

# Statically Assign an IP Address

If you are not using a DHCP capable gateway/router, or you need to assign a static IP address, please follow the steps below:

## Windows® 8 Users

- Press the **Windows** key and then type **IP**. Click **Settings** on the right side and then click **View Network Connections**.
- Right-click on the adapter which represents your D-Link wireless network adapter.
- Highlight **Internet Protocol Version 4 (TCP /IPv4)** and click **Properties**.

- Click **Use the following IP address** and enter an IP address that is on the same subnet as your network or LAN IP address on your router or network.

**Example:** If the router's LAN IP address is 192.168.0.1, make your IP address 192.168.0.X where X is a number between 2 and 99. Make sure that the number you choose is not in use on the network.

- Set **Default Gateway** the same as the LAN IP address of your router or gateway.
- Set **Primary DNS** the same as the LAN IP address of your router or gateway.
- The **Secondary DNS** is optional (you may enter a DNS server from your ISP).
- Click **OK** to save your settings.

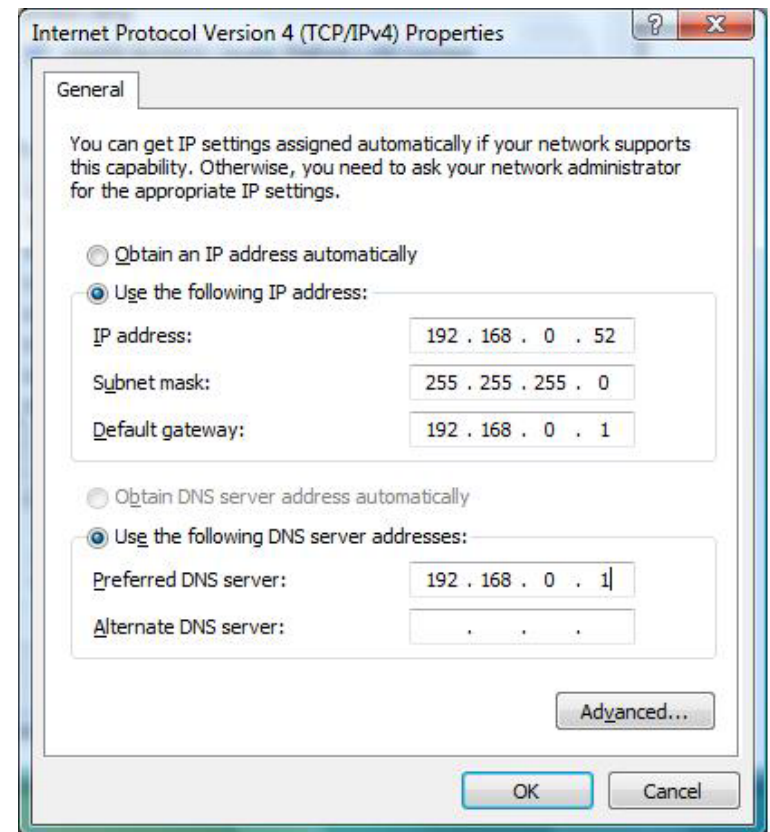

## Windows® 7/ Vista® Users

- Click on **Start > Control Panel** (make sure you are in Classic View). Double-click on the **Network and Sharing Center** icon. If you are using Windows Vista, click on **Manage network connections** along the left panel in the window. For Windows® 7, click on **Change adapter settings**.

- Right-click on the **Local Area Connection** which represents your D-Link wireless network adapter which will be connected to your network.

- Highlight **Internet Protocol Version 4 (TCP /IPv4)** and click **Properties**.

- Click **Use the following IP address** and enter an IP address that is on the same subnet as your network or LAN IP address on your router or network.

**Example:** If the router's LAN IP address is 192.168.0.1, make your IP address 192.168.0.X where X is a number between 2 and 99. Make sure that the number you choose is not in use on the network.

- Set **Default Gateway** the same as the LAN IP address of your router or gateway.
- Set **Primary DNS** the same as the LAN IP address of your router or gateway.
- The **Secondary DNS** is optional (you may enter a DNS server from your ISP).

- Click **OK** to save your settings.

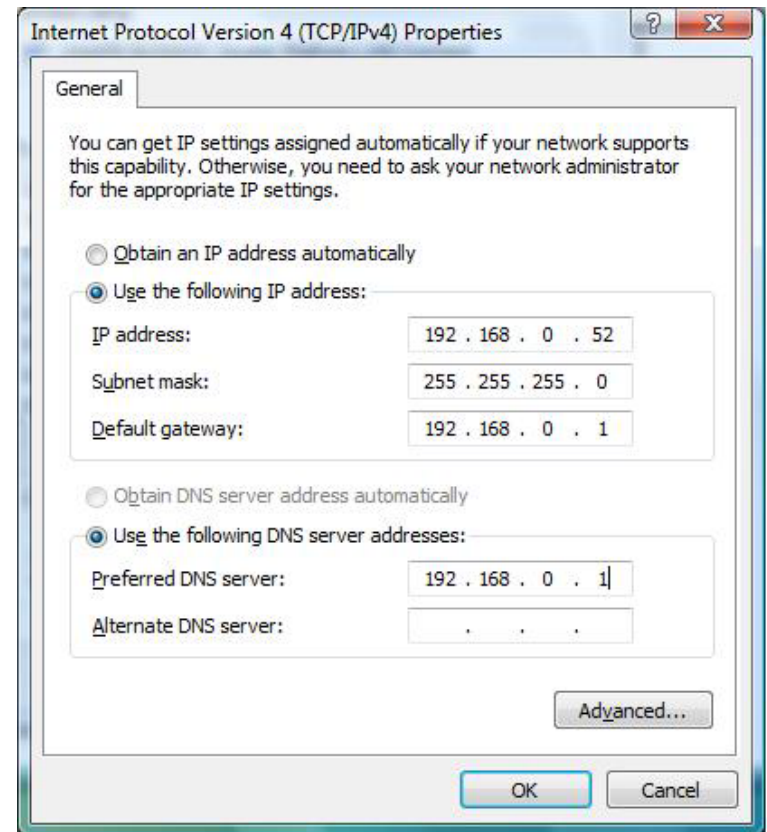

## Windows® XP Users

- Click on **Start > Control Panel**. Make sure you are in Classic View. Double-click on the Network Connections icon.
- Right-click on the **Local Area Connection** which represents your D-Link wireless network adapter (or other adapter) which will be connected to your router.
- Highlight **Internet Protocol (TCP/IP)** and click **Properties**.
- Click **Use the following IP address** and enter an IP address that is on the same subnet as your network or LAN IP address on your router.

**Example:** If the router's LAN IP address is 192.168.0.1, make your IP address 192.168.0.X where X is a number between 2 and 99. Make sure that the number you choose is not in use on the network.

- Set **Default Gateway** the same as the LAN IP address of your router or gateway.
- Set **Primary DNS** as the LAN IP address of your router or gateway.
- The **Secondary DNS** is optional (you may enter a DNS server from your ISP).
- Click **OK** to save your settings.

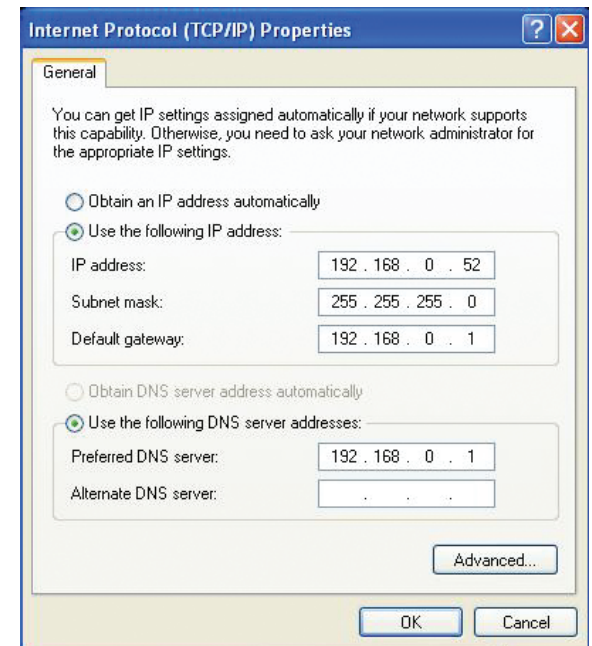

# Technical Specifications

## Standards

- IEEE 802.11ac (draft)
- IEEE 802.11n
- IEEE 802.11g
- IEEE 802.11a
- IEEE 802.11b
- IEEE 802.3
- IEEE 802.3u
- IEEE 802.3ab

## Physical Interface

- 4 Gigabit Ethernet LAN Ports
- 1 Gigabit Ethernet WAN Port
- 1 WPS Push Button
- Reset Button

## Wireless Interface

### 802.11ac (5 GHz)

#### Radio/Modulation

- BPSK
- QPSK
- 16QAM
- 64QAM
- Up to 256QAM with OFDM

## Operating Frequency

- 5150MHz ~ 5250MHz
- 5725MHz ~ 5850MHz

## Media Access Protocol

- CSMA/CA with ACK

## 802.11n

### Radio/Modulation

- BPSK
- QPSK
- 16QAM
- 64QAM with OFDM

## Operating Frequency

### 5GHz Band:

- 5150MHz ~ 5250MHz
- 5725MHz ~ 5850MHz

### 2.4GHz ISM Band:

- 2400MHz ~ 2483.5MHz

## Media Access Protocol

- CSMA/CA with ACK

1 Maximum wireless signal rate derived from IEEE Standard 802.11ac (draft), 802.11a, 802.11g, and 802.11n specifications. Actual data throughput will vary. Network conditions and environmental factors, including volume of network traffic, building materials and construction, and network overhead, lower actual data throughput rate. Environmental factors will adversely affect wireless signal range.

2 Frequency Range varies depending on country's regulation

### **802.11g**

#### **Radio/Modulation**

- BPSK
- QPSK
- 16QAM
- 64QAM
- OFDM

#### **Operating Frequency**

2400 MHz ~ 2483.5MHz ISM Band

#### **Media Access Protocol**

- CSMA/CA with ACK

### **802.11a**

#### **Radio/Modulation**

- BPSK
- QPSK
- 16QAM
- 64QAM with OFDM

#### **Operating Frequency**

- 5150MHz ~ 5250MHz
- 5725MHz ~ 5850MHz

#### **Media Access Protocol**

- CSMA/CA with ACK

### **Security**

- Wi-Fi Protected Access (WPA/WPA2)
- WPS™

1 Maximum wireless signal rate derived from IEEE Standard 802.11ac (draft), 802.11a, 802.11g, and 802.11n specifications. Actual data throughput will vary. Network conditions and environmental factors, including volume of network traffic, building materials and construction, and network overhead, lower actual data throughput rate. Environmental factors will adversely affect wireless signal range.

2 Frequency Range varies depending on country's regulation

### **LEDs**

- Power/WPS
- Internet

### **Power**

- DC 12V/2.5A

### **Operating Temperature**

- 30° to 104° F (0° to 40° C)

### **Operating Humidity**

- 10% to 95% non-condensing

### **Certifications**

- CE
- FCC
- IC
- C-Tick
- CSA international

### **Dimensions**

- 8.58" x 4.92" x 4.05" (218mm x 125mm x 103mm)

### **Weight**

- 1.17 lb (530g)

### **Warranty**

- 1-Year Limited Warranty



# Contacting Technical Support

U.S. and Canadian customers can contact D-Link technical support through our web site or by phone.

Before you contact technical support, please have the following ready:

- Model number of the product (e.g. DIR-868L)
- Hardware Revision (located on the label on the bottom of the router (e.g. rev A1))
- Serial Number (s/n number located on the label on the bottom of the router).

You can find software updates and user documentation on the D-Link website as well as frequently asked questions and answers to technical issues.

## For customers within the United States:

**Phone Support:**

(877) 453-5465

**Internet Support:**

<http://support.dlink.com>

## For customers within Canada:

**Phone Support:**

(800) 361-5265

**Internet Support:**

<http://support.dlink.ca>

# GPL Code Statement

This D-Link product includes software code developed by third parties, including software code subject to the GNU General Public License (“GPL”) or GNU Lesser General Public License (“LGPL”). As applicable, the terms of the GPL and LGPL, and information on obtaining access to the GPL code and LGPL code used in this product, are available to you at:

<http://tsd.dlink.com.tw/GPL.asp>

The GPL code and LGPL code used in this product is distributed WITHOUT ANY WARRANTY and is subject to the copyrights of one or more authors. For details, see the GPL code and the LGPL code for this product and the terms of the GPL and LGPL.

## WRITTEN OFFER FOR GPL AND LGPL SOURCE CODE

Where such specific license terms entitle you to the source code of such software, D-Link will provide upon written request via email and/or traditional paper mail the applicable GPL and LGPL source code files via CD-ROM for a nominal cost to cover shipping and media charges as allowed under the GPL and LGPL.

Please direct all inquiries to:  
Email: [GPLCODE@DLink.com](mailto:GPLCODE@DLink.com)  
Snail Mail:  
Attn: GPLSOURCE REQUEST  
D-Link Systems, Inc.  
17595 Mt. Herrmann Street  
Fountain Valley, CA 92708

## GNU GENERAL PUBLIC LICENSE Version 3, 29 June 2007

Copyright (C) 2007 Free Software Foundation, Inc. <<http://fsf.org/>> Everyone is permitted to copy and distribute verbatim copies of this license document, but changing it is not allowed.

## Preamble

The GNU General Public License is a free, copyleft license for software and other kinds of works.

The licenses for most software and other practical works are designed to take away your freedom to share and change the works. By contrast, the GNU General Public License is intended to guarantee your freedom to share and change all versions of a program—to make sure it remains free software for all its users. We, the Free Software Foundation, use the GNU General Public License for most of our software; it applies also to any other work released this way by its authors. You can apply it to your programs, too.

When we speak of free software, we are referring to freedom, not price. Our General Public Licenses are designed to make sure that you have the freedom to distribute copies of free software (and charge for them if you wish), that you receive source code or can get it if you want it, that you can change the software or use pieces of it in new free programs, and that you know you can do these things.

To protect your rights, we need to prevent others from denying you these rights or asking you to surrender the rights. Therefore, you have certain responsibilities if you distribute copies of the software, or if you modify it: responsibilities to respect the freedom of others.

For example, if you distribute copies of such a program, whether gratis or for a fee, you must pass on to the recipients the same freedoms that you received. You must make sure that they, too, receive or can get the source code. And you must show them these terms so they know their rights.

Developers that use the GNU GPL protect your rights with two steps:

(1) assert copyright on the software, and (2) offer you this License giving you legal permission to copy, distribute and/or modify it.

For the developers' and authors' protection, the GPL clearly explains that there is no warranty for this free software. For both users' and authors' sake, the GPL requires that modified versions be marked as changed, so that their problems will not be attributed erroneously to authors of previous versions.

Some devices are designed to deny users access to install or run modified versions of the software inside them, although the manufacturer can do so. This is fundamentally incompatible with the aim of protecting users' freedom to change the software. The systematic pattern of such abuse occurs in the area of products for individuals to use, which is precisely where it is most unacceptable. Therefore, we have designed this version of the GPL to prohibit the practice for those products. If such problems arise substantially in other domains, we stand ready to extend this provision to those domains in future versions of the GPL, as needed to protect the freedom of users.

Finally, every program is threatened constantly by software patents. States should not allow patents to restrict development and use of software on general-purpose computers, but in those that do, we wish to avoid the special danger that patents applied to a free program could make it effectively proprietary. To prevent this, the GPL assures that patents cannot be used to render the program non-free.

The precise terms and conditions for copying, distribution and modification follow.

## **TERMS AND CONDITIONS**

### **0. Definitions.**

“This License” refers to version 3 of the GNU General Public License.

“Copyright” also means copyright-like laws that apply to other kinds of works, such as semiconductor masks.

“The Program” refers to any copyrightable work licensed under this License. Each licensee is addressed as “you”. “Licensees” and “recipients” may be individuals or organizations.

To “modify” a work means to copy from or adapt all or part of the work in a fashion requiring copyright permission, other than the making of an exact copy. The resulting work is called a “modified version” of the earlier work or a work “based on” the earlier work.

A “covered work” means either the unmodified Program or a work based on the Program.

To “propagate” a work means to do anything with it that, without permission, would make you directly or secondarily liable for infringement under applicable copyright law, except executing it on a computer or modifying a private copy. Propagation includes copying, distribution (with or without modification), making available to the public, and in some countries other activities as well.

To “convey” a work means any kind of propagation that enables other parties to make or receive copies. Mere interaction with a user through a computer network, with no transfer of a copy, is not conveying.

An interactive user interface displays “Appropriate Legal Notices” to the extent that it includes a convenient and prominently visible feature that (1) displays an appropriate copyright notice, and (2) tells the user that there is no warranty for the work (except to the extent that warranties are provided), that licensees may convey the work under this License, and how to view a copy of this License. If the interface presents a list of user commands or options, such as a menu, a prominent item in the list meets this criterion.

### **1. Source Code.**

The “source code” for a work means the preferred form of the work for making modifications to it. “Object code” means any non-source form of a work.

A “Standard Interface” means an interface that either is an official standard defined by a recognized standards body, or, in the case of interfaces specified for a particular programming language, one that is widely used among developers working in that language.

The “System Libraries” of an executable work include anything, other than the work as a whole, that (a) is included in the normal form of packaging a Major Component, but which is not part of that Major Component, and (b) serves only to enable use of the work with that Major Component, or to implement a Standard Interface for which an implementation is available to the public in source code form. A “Major Component”, in this context, means a major essential component (kernel, window system, and so on) of the specific operating system (if any) on which the executable work runs, or a compiler used to produce the work, or an object code interpreter used to run it.

The “Corresponding Source” for a work in object code form means all the source code needed to generate, install, and (for an executable work) run the object code and to modify the work, including scripts to control those activities. However, it does not include the work’s System Libraries, or general-purpose tools or generally available free programs which are used unmodified in performing those activities but which are not part of the work. For example, Corresponding Source includes interface definition files associated with source files for the work, and the source code for shared libraries and dynamically linked subprograms that the work is specifically designed to require, such as by intimate data communication or control flow between those subprograms and other parts of the work.

The Corresponding Source need not include anything that users can regenerate automatically from other parts of the Corresponding Source.

The Corresponding Source for a work in source code form is that same work.

## **2. Basic Permissions.**

All rights granted under this License are granted for the term of copyright on the Program, and are irrevocable provided the stated conditions are met. This License explicitly affirms your unlimited permission to run the unmodified Program. The output from running a covered work is covered by this License only if the output, given its content, constitutes a covered work. This License acknowledges your rights of fair use or other equivalent, as provided by copyright law.

You may make, run and propagate covered works that you do not convey, without conditions so long as your license otherwise remains in force. You may convey covered works to others for the sole purpose of having them make modifications exclusively for you, or provide you with facilities for running those works, provided that you comply with the terms of this License in conveying all material for which you do not control copyright. Those thus making or running the covered works for you must do so exclusively on your behalf, under your direction and control, on terms that prohibit them from making any copies of your copyrighted material outside their relationship with you.

Conveying under any other circumstances is permitted solely under the conditions stated below. Sublicensing is not allowed; section 10 makes it unnecessary.

### **3. Protecting Users' Legal Rights From Anti-Circumvention Law.**

No covered work shall be deemed part of an effective technological measure under any applicable law fulfilling obligations under article 11 of the WIPO copyright treaty adopted on 20 December 1996, or similar laws prohibiting or restricting circumvention of such measures.

When you convey a covered work, you waive any legal power to forbid circumvention of technological measures to the extent such circumvention is effected by exercising rights under this License with respect to the covered work, and you disclaim any intention to limit operation or modification of the work as a means of enforcing, against the work's users, your or third parties' legal rights to forbid circumvention of technological measures.

### **4. Conveying Verbatim Copies.**

You may convey verbatim copies of the Program's source code as you receive it, in any medium, provided that you conspicuously and appropriately publish on each copy an appropriate copyright notice; keep intact all notices stating that this License and any non-permissive terms added in accord with section 7 apply to the code; keep intact all notices of the absence of any warranty; and give all recipients a copy of this License along with the Program.

You may charge any price or no price for each copy that you convey, and you may offer support or warranty protection for a fee.

### **5. Conveying Modified Source Versions.**

You may convey a work based on the Program, or the modifications to produce it from the Program, in the form of source code under the terms of section 4, provided that you also meet all of these conditions:

- a) The work must carry prominent notices stating that you modified it, and giving a relevant date.
- b) The work must carry prominent notices stating that it is released under this License and any conditions added under section 7. This requirement modifies the requirement in section 4 to "keep intact all notices".
- c) You must license the entire work, as a whole, under this License to anyone who comes into possession of a copy. This License will therefore apply, along with any applicable section 7 additional terms, to the whole of the work, and all its parts, regardless of how they are packaged. This License gives no permission to license the work in any other way, but it does not invalidate such permission if you have separately received it.
- d) If the work has interactive user interfaces, each must display Appropriate Legal Notices; however, if the Program has interactive interfaces that do not display Appropriate Legal Notices, your work need not make them do so.

A compilation of a covered work with other separate and independent works, which are not by their nature extensions of the covered work, and which are not combined with it such as to form a larger program, in or on a volume of a storage or distribution medium, is called an “aggregate” if the compilation and its resulting copyright are not used to limit the access or legal rights of the compilation’s users beyond what the individual works permit. Inclusion of a covered work in an aggregate does not cause this License to apply to the other parts of the aggregate.

### **6. Conveying Non-Source Forms.**

You may convey a covered work in object code form under the terms of sections 4 and 5, provided that you also convey the machine-readable Corresponding Source under the terms of this License, in one of these ways:

- a) Convey the object code in, or embodied in, a physical product (including a physical distribution medium), accompanied by the Corresponding Source fixed on a durable physical medium customarily used for software interchange.
- b) Convey the object code in, or embodied in, a physical product (including a physical distribution medium), accompanied by a written offer, valid for at least three years and valid for as long as you offer spare parts or customer support for that product model, to give anyone who possesses the object code either (1) a copy of the Corresponding Source for all the software in the product that is covered by this License, on a durable physical medium customarily used for software interchange, for a price no more than your reasonable cost of physically performing this conveying of source, or (2) access to copy the Corresponding Source from a network server at no charge.
- c) Convey individual copies of the object code with a copy of the written offer to provide the Corresponding Source. This alternative is allowed only occasionally and noncommercially, and only if you received the object code with such an offer, in accord with subsection 6b.
- d) Convey the object code by offering access from a designated place (gratis or for a charge), and offer equivalent access to the Corresponding Source in the same way through the same place at no further charge. You need not require recipients to copy the Corresponding Source along with the object code. If the place to copy the object code is a network server, the Corresponding Source may be on a different server (operated by you or a third party) that supports equivalent copying facilities, provided you maintain clear directions next to the object code saying where to find the Corresponding Source. Regardless of what server hosts the Corresponding Source, you remain obligated to ensure that it is available for as long as needed to satisfy these requirements.
- e) Convey the object code using peer-to-peer transmission, provided you inform other peers where the object code and Corresponding Source of the work are being offered to the general public at no charge under subsection 6d.

A separable portion of the object code, whose source code is excluded from the Corresponding Source as a System Library, need not be included in conveying the object code work.

A “User Product” is either (1) a “consumer product”, which means any tangible personal property which is normally used for personal, family, or household purposes, or (2) anything designed or sold for incorporation into a dwelling. In determining whether a product is a consumer product, doubtful cases shall be resolved in favor of coverage. For a particular product received by a particular user, “normally used” refers to a typical or common use of that class of product, regardless of the status of the particular user or of the way in which the particular user actually uses, or expects or is expected to use, the product. A product is a consumer product regardless of whether the product has substantial commercial, industrial or non-consumer uses, unless such uses represent the only significant mode of use of the product.

“Installation Information” for a User Product means any methods, procedures, authorization keys, or other information required to install and execute modified versions of a covered work in that User Product from a modified version of its Corresponding Source. The information must suffice to ensure that the continued functioning of the modified object code is in no case prevented or interfered with solely because modification has been made.

If you convey an object code work under this section in, or with, or specifically for use in, a User Product, and the conveying occurs as part of a transaction in which the right of possession and use of the User Product is transferred to the recipient in perpetuity or for a fixed term (regardless of how the transaction is characterized), the Corresponding Source conveyed under this section must be accompanied by the Installation Information. But this requirement does not apply if neither you nor any third party retains the ability to install modified object code on the User Product (for example, the work has been installed in ROM).

The requirement to provide Installation Information does not include a requirement to continue to provide support service, warranty, or updates for a work that has been modified or installed by the recipient, or for the User Product in which it has been modified or installed. Access to a network may be denied when the modification itself materially and adversely affects the operation of the network or violates the rules and protocols for communication across the network.

Corresponding Source conveyed, and Installation Information provided, in accord with this section must be in a format that is publicly documented (and with an implementation available to the public in source code form), and must require no special password or key for unpacking, reading or copying.

## **7. Additional Terms.**

“Additional permissions” are terms that supplement the terms of this License by making exceptions from one or more of its conditions. Additional permissions that are applicable to the entire Program shall be treated as though they were included in this License, to the extent that they are valid under applicable law. If additional permissions apply only to part of the Program, that part may be used separately under those permissions, but the entire Program remains governed by this License without regard to the additional permissions.



When you convey a copy of a covered work, you may at your option remove any additional permissions from that copy, or from any part of it. (Additional permissions may be written to require their own removal in certain cases when you modify the work). You may place additional permissions on material, added by you to a covered work, for which you have or can give appropriate copyright permission.

Notwithstanding any other provision of this License, for material you add to a covered work, you may (if authorized by the copyright holders of that material) supplement the terms of this License with terms:

- a) Disclaiming warranty or limiting liability differently from the terms of sections 15 and 16 of this License; or
- b) Requiring preservation of specified reasonable legal notices or author attributions in that material or in the Appropriate Legal Notices displayed by works containing it; or
- c) Prohibiting misrepresentation of the origin of that material, or requiring that modified versions of such material be marked in reasonable ways as different from the original version; or
- d) Limiting the use for publicity purposes of names of licensors or authors of the material; or
- e) Declining to grant rights under trademark law for use of some trade names, trademarks, or service marks; or
- f) Requiring indemnification of licensors and authors of that material by anyone who conveys the material (or modified versions of it) with contractual assumptions of liability to the recipient, for any liability that these contractual assumptions directly impose on those licensors and authors.

All other non-permissive additional terms are considered “further restrictions” within the meaning of section 10. If the Program as you received it, or any part of it, contains a notice stating that it is governed by this License along with a term that is a further restriction, you may remove that term. If a license document contains a further restriction but permits relicensing or conveying under this License, you may add to a covered work material governed by the terms of that license document, provided that the further restriction does not survive such relicensing or conveying.

If you add terms to a covered work in accord with this section, you must place, in the relevant source files, a statement of the additional terms that apply to those files, or a notice indicating where to find the applicable terms.

Additional terms, permissive or non-permissive, may be stated in the form of a separately written license, or stated as exceptions; the above requirements apply either way.

## **8. Termination.**

You may not propagate or modify a covered work except as expressly provided under this License. Any attempt otherwise to propagate or modify it is void, and will automatically terminate your rights under this License (including any patent licenses granted under the third paragraph of section 11).

However, if you cease all violation of this License, then your license from a particular copyright holder is reinstated (a) provisionally, unless and until the copyright holder explicitly and finally terminates your license, and (b) permanently, if the copyright holder fails to notify you of the violation by some reasonable means prior to 60 days after the cessation.

Moreover, your license from a particular copyright holder is reinstated permanently if the copyright holder notifies you of the violation by some reasonable means, this is the first time you have received notice of violation of this License (for any work) from that copyright holder, and you cure the violation prior to 30 days after your receipt of the notice.

Termination of your rights under this section does not terminate the licenses of parties who have received copies or rights from you under this License. If your rights have been terminated and not permanently reinstated, you do not qualify to receive new licenses for the same material under section 10.

## **9. Acceptance Not Required for Having Copies.**

You are not required to accept this License in order to receive or run a copy of the Program. Ancillary propagation of a covered work occurring solely as a consequence of using peer-to-peer transmission to receive a copy likewise does not require acceptance. However, nothing other than this License grants you permission to propagate or modify any covered work. These actions infringe copyright if you do not accept this License. Therefore, by modifying or propagating a covered work, you indicate your acceptance of this License to do so.

## **10. Automatic Licensing of Downstream Recipients.**

Each time you convey a covered work, the recipient automatically receives a license from the original licensors, to run, modify and propagate that work, subject to this License. You are not responsible for enforcing compliance by third parties with this License.

An “entity transaction” is a transaction transferring control of an organization, or substantially all assets of one, or subdividing an organization, or merging organizations. If propagation of a covered work results from an entity transaction, each party to that transaction who receives a copy of the work also receives whatever licenses to the work the party’s predecessor in interest had or could give under the previous paragraph, plus a right to possession of the Corresponding Source of the work from the predecessor in interest, if the predecessor has it or can get it with reasonable efforts.

You may not impose any further restrictions on the exercise of the rights granted or affirmed under this License. For example, you may not impose a license fee, royalty, or other charge for exercise of rights granted under this License, and you may not initiate litigation (including a cross-claim or counterclaim in a lawsuit) alleging that any patent claim is infringed by making, using, selling, offering for sale, or importing the Program or any portion of it.

## **11. Patents.**

A “contributor” is a copyright holder who authorizes use under this License of the Program or a work on which the Program is based. The work thus licensed is called the contributor’s “contributor version”.

A contributor’s “essential patent claims” are all patent claims owned or controlled by the contributor, whether already acquired or hereafter acquired, that would be infringed by some manner, permitted by this License, of making, using, or selling its contributor version, but do not include claims that would be infringed only as a consequence of further modification of the contributor version. For purposes of this definition, “control” includes the right to grant patent sublicenses in a manner consistent with the requirements of this License.

Each contributor grants you a non-exclusive, worldwide, royalty-free patent license under the contributor’s essential patent claims, to make, use, sell, offer for sale, import and otherwise run, modify and propagate the contents of its contributor version.

In the following three paragraphs, a “patent license” is any express agreement or commitment, however denominated, not to enforce a patent (such as an express permission to practice a patent or covenant not to sue for patent infringement). To “grant” such a patent license to a party means to make such an agreement or commitment not to enforce a patent against the party.

If you convey a covered work, knowingly relying on a patent license, and the Corresponding Source of the work is not available for anyone to copy, free of charge and under the terms of this License, through a publicly available network server or other readily accessible means, then you must either (1) cause the Corresponding Source to be so available, or (2) arrange to deprive yourself of the benefit of the patent license for this particular work, or (3) arrange, in a manner consistent with the requirements of this License, to extend the patent license to downstream recipients. “Knowingly relying” means you have actual knowledge that, but for the patent license, your conveying the covered work in a country, or your recipient’s use of the covered work in a country, would infringe one or more identifiable patents in that country that you have reason to believe are valid.

If, pursuant to or in connection with a single transaction or arrangement, you convey, or propagate by procuring conveyance of, a covered work, and grant a patent license to some of the parties receiving the covered work authorizing them to use, propagate, modify or convey a specific copy of the covered work, then the patent license you grant is automatically extended to all recipients of the covered work and works based on it.

A patent license is “discriminatory” if it does not include within the scope of its coverage, prohibits the exercise of, or is conditioned on the non-exercise of one or more of the rights that are specifically granted under this License. You may not convey a covered work if you are a party to an arrangement with a third party that is in the business of distributing software, under which you make payment to the third party based on the extent of your activity of conveying the work, and under which the third party grants, to any of the parties who would receive the covered work from you, a discriminatory patent license (a) in connection with copies of the covered work conveyed by you (or copies made from those copies), or (b) primarily for and in connection with specific products or compilations that contain the covered work, unless you entered into that arrangement, or that patent license was granted, prior to 28 March 2007.

Nothing in this License shall be construed as excluding or limiting any implied license or other defenses to infringement that may otherwise be available to you under applicable patent law.

### **12. No Surrender of Others’ Freedom.**

If conditions are imposed on you (whether by court order, agreement or otherwise) that contradict the conditions of this License, they do not excuse you from the conditions of this License. If you cannot convey a covered work so as to satisfy simultaneously your obligations under this License and any other pertinent obligations, then as a consequence you may not convey it at all. For example, if you agree to terms that obligate you to collect a royalty for further conveying from those to whom you convey the Program, the only way you could satisfy both those terms and this License would be to refrain entirely from conveying the Program.

### **13. Use with the GNU Affero General Public License.**

Notwithstanding any other provision of this License, you have permission to link or combine any covered work with a work licensed under version 3 of the GNU Affero General Public License into a single combined work, and to convey the resulting work. The terms of this License will continue to apply to the part which is the covered work, but the special requirements of the GNU Affero General Public License, section 13, concerning interaction through a network will apply to the combination as such.

### **14. Revised Versions of this License.**

The Free Software Foundation may publish revised and/or new versions of the GNU General Public License from time to time. Such new versions will be similar in spirit to the present version, but may differ in detail to address new problems or concerns.

Each version is given a distinguishing version number. If the Program specifies that a certain numbered version of the GNU General Public License “or any later version” applies to it, you have the option of following the terms and conditions either of that numbered version or of any later version published by the Free Software Foundation. If the Program does not specify a version number of the GNU General Public License, you may choose any version ever published by the Free Software Foundation. If the Program specifies that a proxy can decide which future versions of the GNU General Public License can be used, that proxy’s public statement of acceptance of a version permanently authorizes you to choose that version for the Program.

Later license versions may give you additional or different permissions. However, no additional obligations are imposed on any author or copyright holder as a result of your choosing to follow a later version.

### **15. Disclaimer of Warranty.**

THERE IS NO WARRANTY FOR THE PROGRAM, TO THE EXTENT PERMITTED BY APPLICABLE LAW. EXCEPT WHEN OTHERWISE STATED IN WRITING THE COPYRIGHT HOLDERS AND/OR OTHER PARTIES PROVIDE THE PROGRAM "AS IS" WITHOUT WARRANTY OF ANY KIND, EITHER EXPRESSED OR IMPLIED, INCLUDING, BUT NOT LIMITED TO, THE IMPLIED WARRANTIES OF MERCHANTABILITY AND FITNESS FOR A PARTICULAR PURPOSE. THE ENTIRE RISK AS TO THE QUALITY AND PERFORMANCE OF THE PROGRAM IS WITH YOU. SHOULD THE PROGRAM PROVE DEFECTIVE, YOU ASSUME THE COST OF ALL NECESSARY SERVICING, REPAIR OR CORRECTION.

### **16. Limitation of Liability.**

IN NO EVENT UNLESS REQUIRED BY APPLICABLE LAW OR AGREED TO IN WRITING WILL ANY COPYRIGHT HOLDER, OR ANY OTHER PARTY WHO MODIFIES AND/OR CONVEYS THE PROGRAM AS PERMITTED ABOVE, BE LIABLE TO YOU FOR DAMAGES, INCLUDING ANY GENERAL, SPECIAL, INCIDENTAL OR CONSEQUENTIAL DAMAGES ARISING OUT OF THE USE OR INABILITY TO USE THE PROGRAM (INCLUDING BUT NOT LIMITED TO LOSS OF DATA OR DATA BEING RENDERED INACCURATE OR LOSSES SUSTAINED BY YOU OR THIRD PARTIES OR A FAILURE OF THE PROGRAM TO OPERATE WITH ANY OTHER PROGRAMS), EVEN IF SUCH HOLDER OR OTHER PARTY HAS BEEN ADVISED OF THE POSSIBILITY OF SUCH DAMAGES.

### **17. Interpretation of Sections 15 and 16.**

If the disclaimer of warranty and limitation of liability provided above cannot be given local legal effect according to their terms, reviewing courts shall apply local law that most closely approximates an absolute waiver of all civil liability in connection with the Program, unless a warranty or assumption of liability accompanies a copy of the Program in return for a fee.

# Warranty

Subject to the terms and conditions set forth herein, D-Link Systems, Inc. (“D-Link”) provides this Limited Warranty:

- Only to the person or entity that originally purchased the product from D-Link or its authorized reseller or distributor, and
- Only for products purchased and delivered within the fifty states of the United States, the District of Columbia, U.S. Possessions or Protectorates, U.S. Military Installations, or addresses with an APO or FPO.

## **Limited Warranty:**

D-Link warrants that the hardware portion of the D-Link product described below (“Hardware”) will be free from material defects in workmanship and materials under normal use from the date of original retail purchase of the product, for the period set forth below (“Warranty Period”), except as otherwise stated herein.

- Hardware (excluding power supplies and fans): One (1) year
- Power supplies and fans: One (1) year
- Spare parts and spare kits: Ninety (90) days

The customer’s sole and exclusive remedy and the entire liability of D-Link and its suppliers under this Limited Warranty will be, at D-Link’s option, to repair or replace the defective Hardware during the Warranty Period at no charge to the original owner or to refund the actual purchase price paid. Any repair or replacement will be rendered by D-Link at an Authorized D-Link Service Office. The replacement hardware need not be new or have an identical make, model or part. D-Link may, at its option, replace the defective Hardware or any part thereof with any reconditioned product that D-Link reasonably determines is substantially equivalent (or superior) in all material respects to the defective Hardware. Repaired or replacement hardware will be warranted for the remainder of the original Warranty Period or ninety (90) days, whichever is longer, and is subject to the same limitations and exclusions. If a material defect is incapable of correction, or if D-Link determines that it is not practical to repair or replace the defective Hardware, the actual price paid by the original purchaser for the defective Hardware will be refunded by D-Link upon return to D-Link of the defective Hardware. All Hardware or part thereof that is replaced by D-Link, or for which the purchase price is refunded, shall become the property of D-Link upon replacement or refund.

### **Limited Software Warranty:**

D-Link warrants that the software portion of the product (“Software”) will substantially conform to D-Link’s then current functional specifications for the Software, as set forth in the applicable documentation, from the date of original retail purchase of the Software for a period of ninety (90) days (“Software Warranty Period”), provided that the Software is properly installed on approved hardware and operated as contemplated in its documentation. D-Link further warrants that, during the Software Warranty Period, the magnetic media on which D-Link delivers the Software will be free of physical defects. The customer’s sole and exclusive remedy and the entire liability of D-Link and its suppliers under this Limited Warranty will be, at D-Link’s option, to replace the non-conforming Software (or defective media) with software that substantially conforms to D-Link’s functional specifications for the Software or to refund the portion of the actual purchase price paid that is attributable to the Software. Except as otherwise agreed by D-Link in writing, the replacement Software is provided only to the original licensee, and is subject to the terms and conditions of the license granted by D-Link for the Software. Replacement Software will be warranted for the remainder of the original Warranty Period and is subject to the same limitations and exclusions. If a material non-conformance is incapable of correction, or if D-Link determines in its sole discretion that it is not practical to replace the non-conforming Software, the price paid by the original licensee for the non-conforming Software will be refunded by D-Link; provided that the non-conforming Software (and all copies thereof) is first returned to D-Link. The license granted respecting any Software for which a refund is given automatically terminates.

### **Non-Applicability of Warranty:**

The Limited Warranty provided hereunder for Hardware and Software portions of D-Link’s products will not be applied to and does not cover any refurbished product and any product purchased through the inventory clearance or liquidation sale or other sales in which D-Link, the sellers, or the liquidators expressly disclaim their warranty obligation pertaining to the product and in that case, the product is being sold “As-Is” without any warranty whatsoever including, without limitation, the Limited Warranty as described herein, notwithstanding anything stated herein to the contrary.

### **Submitting A Claim (USA):**

The customer shall return the product to the original purchase point based on its return policy. In case the return policy period has expired and the product is within warranty, the customer shall submit a claim to D-Link as outlined below:

- The customer must submit with the product as part of the claim a written description of the Hardware defect or Software nonconformance in sufficient detail to allow DLink to confirm the same, along with proof of purchase of the product (such as a copy of the dated purchase invoice for the product) if the product is not registered.
- The customer must obtain a Case ID Number from D-Link Technical Support at 1-877-453-5465, who will attempt to assist the customer in resolving any suspected defects with the product. If the product is considered defective, the customer must obtain a Return Material Authorization (“RMA”) number by completing the RMA form and entering the assigned Case ID Number at <https://rma.dlink.com/>.

- After an RMA number is issued, the defective product must be packaged securely in the original or other suitable shipping package to ensure that it will not be damaged in transit, and the RMA number must be prominently marked on the outside of the package. Do not include any manuals or accessories in the shipping package. D-Link will only replace the defective portion of the product and will not ship back any accessories.
- The customer is responsible for all in-bound shipping charges to D-Link. No Cash on Delivery (“COD”) is allowed. Products sent COD will either be rejected by D-Link or become the property of D-Link. Products shall be fully insured by the customer and shipped to D-Link Systems, Inc., 17595 Mt. Herrmann, Fountain Valley, CA 92708. D-Link will not be held responsible for any packages that are lost in transit to D-Link. The repaired or replaced packages will be shipped to the customer via UPS Ground or any common carrier selected by D-Link. Return shipping charges shall be prepaid by D-Link if you use an address in the United States, otherwise we will ship the product to you freight collect. Expedited shipping is available upon request and provided shipping charges are prepaid by the customer. D-Link may reject or return any product that is not packaged and shipped in strict compliance with the foregoing requirements, or for which an RMA number is not visible from the outside of the package. The product owner agrees to pay D-Link’s reasonable handling and return shipping charges for any product that is not packaged and shipped in accordance with the foregoing requirements, or that is determined by D-Link not to be defective or non-conforming.

**Submitting A Claim (Canada):**

The customer shall return the product to the original purchase point based on its return policy. In case the return policy period has expired and the product is within warranty, the customer shall submit a claim to D-Link as outlined below:

- Customers need to provide their receipt (proof of purchase) even if the product is registered. Without a receipt, no warranty service will be done. The registration is not considered a proof of purchase.
- The customer must submit with the product as part of the claim a written description of the Hardware defect or Software nonconformance in sufficient detail to allow D-Link to confirm the same, along with proof of purchase of the product (such as a copy of the dated purchase invoice for the product) if the product is not registered.
- The customer must obtain a Case ID Number from D-Link Technical Support at 1-800-361-5265, who will attempt to assist the customer in resolving any suspected defects with the product. If the product is considered defective, the customer must obtain a Return Material Authorization (“RMA”) number by completing the RMA form and entering the assigned Case ID Number at <https://rma.dlink.ca/>.
- After an RMA number is issued, the defective product must be packaged securely in the original or other suitable shipping package to ensure that it will not be damaged in transit, and the RMA number must be prominently marked on the outside of the package. Do not include any manuals or accessories in the shipping package. D-Link will only replace the defective portion of the product and will not ship back any accessories.



- The customer is responsible for all in-bound shipping charges to D-Link. No Cash on Delivery (“COD”) is allowed. Products sent COD will be rejected by D-Link. Products shall be fully insured by the customer and shipped to D-Link Networks, Inc., 2525 Meadowvale Boulevard Mississauga, Ontario, L5N 5S2 Canada. D-Link will not be held responsible for any packages that are lost in transit to D-Link. The repaired or replaced packages will be shipped to the customer via Purolator Canada or any common carrier selected by D-Link. Return shipping charges shall be prepaid by D-Link if you use an address in Canada, otherwise we will ship the product to you freight collect. Expedited shipping is available upon request and provided shipping charges are prepaid by the customer. D-Link may reject or return any product that is not packaged and shipped in strict compliance with the foregoing requirements, or for which an RMA number is not visible from the outside of the package. The product owner agrees to pay D-Link’s reasonable handling and return shipping charges for any product that is not packaged and shipped in accordance with the foregoing requirements, or that is determined by D-Link not to be defective or non-conforming.
- RMA phone number: 1-800-361-5265 Hours of Operation: Monday-Friday, 9:00AM – 9:00PM EST

### **What Is Not Covered:**

The Limited Warranty provided herein by D-Link does not cover:

Products that, in D-Link’s judgment, have been subjected to abuse, accident, alteration, modification, tampering, negligence, misuse, faulty installation, lack of reasonable care, repair or service in any way that is not contemplated in the documentation for the product, or if the model or serial number has been altered, tampered with, defaced or removed; Initial installation, installation and removal of the product for repair, and shipping costs; Operational adjustments covered in the operating manual for the product, and normal maintenance; Damage that occurs in shipment, due to act of God, failures due to power surge, and cosmetic damage; Any hardware, software, firmware or other products or services provided by anyone other than D-Link; and Products that have been purchased from inventory clearance or liquidation sales or other sales in which D-Link, the sellers, or the liquidators expressly disclaim their warranty obligation pertaining to the product.

While necessary maintenance or repairs on your Product can be performed by any company, we recommend that you use only an Authorized D-Link Service Office. Improper or incorrectly performed maintenance or repair voids this Limited Warranty.

### **Disclaimer of Other Warranties:**

EXCEPT FOR THE LIMITED WARRANTY SPECIFIED HEREIN, THE PRODUCT IS PROVIDED “AS-IS” WITHOUT ANY WARRANTY OF ANY KIND WHATSOEVER INCLUDING, WITHOUT LIMITATION, ANY WARRANTY OF MERCHANTABILITY, FITNESS FOR A PARTICULAR PURPOSE AND NONINFRINGEMENT.

IF ANY IMPLIED WARRANTY CANNOT BE DISCLAIMED IN ANY TERRITORY WHERE A PRODUCT IS SOLD, THE DURATION OF SUCH IMPLIED WARRANTY SHALL BE LIMITED TO THE DURATION OF THE APPLICABLE WARRANTY PERIOD SET FORTH ABOVE. EXCEPT AS EXPRESSLY COVERED UNDER THE LIMITED WARRANTY PROVIDED HEREIN, THE ENTIRE RISK AS TO THE QUALITY, SELECTION AND PERFORMANCE OF THE PRODUCT IS WITH THE PURCHASER OF THE PRODUCT.

**Limitation of Liability:**

TO THE MAXIMUM EXTENT PERMITTED BY LAW, D-LINK IS NOT LIABLE UNDER ANY CONTRACT, NEGLIGENCE, STRICT LIABILITY OR OTHER LEGAL OR EQUITABLE THEORY FOR ANY LOSS OF USE OF THE PRODUCT, INCONVENIENCE OR DAMAGES OF ANY CHARACTER, WHETHER DIRECT, SPECIAL, INCIDENTAL OR CONSEQUENTIAL (INCLUDING, BUT NOT LIMITED TO, DAMAGES FOR LOSS OF GOODWILL, LOSS OF REVENUE OR PROFIT, WORK STOPPAGE, COMPUTER FAILURE OR MALFUNCTION, FAILURE OF OTHER EQUIPMENT OR COMPUTER PROGRAMS TO WHICH D-LINK'S PRODUCT IS CONNECTED WITH, LOSS OF INFORMATION OR DATA CONTAINED IN, STORED ON, OR INTEGRATED WITH ANY PRODUCT RETURNED TO D-LINK FOR WARRANTY SERVICE) RESULTING FROM THE USE OF THE PRODUCT, RELATING TO WARRANTY SERVICE, OR ARISING OUT OF ANY BREACH OF THIS LIMITED WARRANTY, EVEN IF D-LINK HAS BEEN ADVISED OF THE POSSIBILITY OF SUCH DAMAGES. THE SOLE REMEDY FOR A BREACH OF THE FOREGOING LIMITED WARRANTY IS REPAIR, REPLACEMENT OR REFUND OF THE DEFECTIVE OR NONCONFORMING PRODUCT. THE MAXIMUM LIABILITY OF D-LINK UNDER THIS WARRANTY IS LIMITED TO THE PURCHASE PRICE OF THE PRODUCT COVERED BY THE WARRANTY. THE FOREGOING EXPRESS WRITTEN WARRANTIES AND REMEDIES ARE EXCLUSIVE AND ARE IN LIEU OF ANY OTHER WARRANTIES OR REMEDIES, EXPRESS, IMPLIED OR STATUTORY.

**Governing Law:**

This Limited Warranty shall be governed by the laws of the State of California. Some states do not allow exclusion or limitation of incidental or consequential damages, or limitations on how long an implied warranty lasts, so the foregoing limitations and exclusions may not apply. This Limited Warranty provides specific legal rights and you may also have other rights which vary from state to state.

**Trademarks:**

D-Link is a registered trademark of D-Link Corporation/D-Link Systems, Inc. Other trademarks or registered trademarks are the property of their respective owners.

**Copyright Statement:**

No part of this publication or documentation accompanying this product may be reproduced in any form or by any means or used to make any derivative such as translation, transformation, or adaptation without permission from D-Link Corporation/D-Link Systems, Inc., as stipulated by the United States Copyright Act of 1976 and any amendments thereto. Contents are subject to change without prior notice.

Copyright ©2013 by D-Link Corporation/D-Link Systems, Inc. All rights reserved.

**CE Mark Warning:**

This is a Class B product. In a domestic environment, this product may cause radio interference, in which case the user may be required to take adequate measures.

**FCC Statement:**

This equipment has been tested and found to comply with the limits for a Class B digital device, pursuant to Part 15 of the FCC Rules. These limits are designed to provide reasonable protection against harmful interference in a residential installation. This equipment generates, uses and can radiate radio frequency energy and, if not installed and used in accordance with the instructions, may cause harmful interference to radio communications. However, there is no guarantee that interference will not occur in a particular installation. If this equipment does cause harmful interference to radio or television reception, which can be determined by turning the equipment off and on, the user is encouraged to try to correct the interference by one of the following measures:

- Reorient or relocate the receiving antenna.
- Increase the separation between the equipment and receiver.
- Connect the equipment into an outlet on a circuit different from that to which the receiver is connected.
- Consult the dealer or an experienced radio/TV technician for help.

This device complies with Part 15 of the FCC Rules. Operation is subject to the following two conditions: (1) This device may not cause harmful interference, and (2) this device must accept any interference received, including interference that may cause undesired operation.

**FCC Caution:**

Any changes or modifications not expressly approved by the party responsible for compliance could void the user's authority to operate this equipment.

Operations in the 5.15-5.25GHz / 5.470 ~ 5.725GHz band are restricted to indoor usage only.

**IMPORTANT NOTICE:****FCC Radiation Exposure Statement:**

This equipment complies with FCC radiation exposure limits set forth for an uncontrolled environment. This equipment should be installed and operated with minimum distance 20cm between the radiator & your body. To maintain compliance with FCC RF exposure compliance requirements, please avoid direct contact to the transmitting antenna during transmitting.

If this device is going to be operated in 5.15 ~ 5.25GHz frequency range, then it is restricted in indoor environment only. This transmitter must not be co-located or operating in conjunction with any other antenna or transmitter.

The availability of some specific channels and/or operational frequency bands are country dependent and are firmware programmed at the factory to match the intended destination. The firmware setting is not accessible by the end user.

**ICC Notice:**

Operation is subject to the following two conditions:

- 1) This device may not cause interference and
- 2) This device must accept any interference, including interference that may cause undesired operation of the device.

**IMPORTANT NOTE:**

**IC Radiation Exposure Statement:**

This equipment complies with IC radiation exposure limits set forth for an uncontrolled environment. End users must follow the specific operating instructions for satisfying RF exposure compliance. This equipment should be installed and operated with minimum distance 20cm between the radiator & your body.

This transmitter must not be co-located or operating in conjunction with any other antenna or transmitter.

- (i) The device for the band 5150-5250 MHz is only for indoor usage to reduce potential for harmful interference to co-channel mobile satellite systems;
- (ii) The maximum antenna gain (2dBi) permitted (for devices in the band 5725-5825 MHz) to comply with the e.i.r.p. limits specified for point-to-point and non point-to-point operation as appropriate, as stated in section A9.2(3).

In addition, users should also be cautioned to take note that high-power radars are allocated as primary users (meaning they have priority) of the bands 5250-5350 MHz and 5650-5850 MHz and these radars could cause interference and/or damage to LE-LAN devices.

**Règlement d'Industry Canada**

Les conditions de fonctionnement sont sujettes à deux conditions:

- (1) Ce périphérique ne doit pas causer d'interférence et.
- (2) Ce périphérique doit accepter toute interférence, y compris les interférences pouvant perturber le bon fonctionnement de ce périphérique.

# Registration

Register your product online at [registration.dlink.com](http://registration.dlink.com)



Product registration is entirely voluntary and failure to complete or return this form will not diminish your warranty rights.

Version 1.0  
April 19, 2013