



User Manual

AC1900 Wi-Fi Router

DIR-879

Preface

D-Link reserves the right to revise this publication and to make changes in the content hereof without obligation to notify any person or organization of such revisions or changes.

Manual Revisions

Revision	Date	Description
1.00	February 4, 2016	Initial release

Trademarks

D-Link and the D-Link logo are trademarks or registered trademarks of D-Link Corporation or its subsidiaries in the United States or other countries. All other company or product names mentioned herein are trademarks or registered trademarks of their respective companies.

Apple®, Apple logo®, Safari®, iPhone®, iPad®, iPod touch® and Macintosh® are trademarks of Apple Inc., registered in the U.S. and other countries. App StoreSM is a service mark of Apple Inc.

Chrome™ browser, Google Play™ and Android™ are trademarks of Google Inc.

Internet Explorer®, Windows® and the Windows logo are trademarks of the Microsoft group of companies.

Copyright © 2016 by D-Link Corporation, Inc.

All rights reserved. This publication may not be reproduced, in whole or in part, without prior expressed written permission from D-Link Corporation, Inc.

Power Usage

This device is an Energy Related Product (ErP) with High Network Availability (HiNA), and automatically switches to a power-saving Network Standby mode within 1 minute of no packets being transmitted. It can also be turned off through a power switch to save energy when it is not needed.

Network Standby: 5.82 watts

Switched Off: 0.08 watts

Table of Contents

Preface	i	Access Point - Extender Mode	31
		Setup Wizard	32
Product Overview	1	Configuration - Router Mode	35
Package Contents.....	1	Home	36
System Requirements.....	2	Internet.....	36
Introduction	3	DIR-879.....	37
Features.....	5	Connected Clients.....	38
Hardware Overview.....	6	Settings	39
LED Indicator.....	6	Wizard.....	39
Back Panel	7	Internet.....	39
Operation Modes.....	8	IPv6	49
Router Mode.....	9	Wireless	66
Extender Mode.....	10	Guest Zone.....	69
Access Point.....	11	Network.....	70
Extender.....	12	Features.....	72
Installation	13	QoS Engine.....	72
Before you Begin.....	13	Firewall Settings.....	73
Wireless Installation Considerations.....	14	IPv4/IPv6 Rules	75
Antenna Setup.....	15	Port Forwarding	76
Hardware Setup	16	Virtual Server.....	77
Router Mode.....	16	Website Filter.....	78
Extender - Access Point Mode.....	19	Static Routes.....	79
Getting Started	21	IPv6	80
Router Mode	21	Dynamic DNS	81
QRS Mobile App.....	22	IPv6 Host.....	82
Setup Wizard	27	Management.....	83

Time & Schedule	83	WPA/WPA2	109
Time	83	Windows® 7.....	111
Schedule	84	WPA/WPA2	111
System Log.....	85	WPS.....	114
Admin	87	Windows Vista®	118
System	88	WPA/WPA2	119
Upgrade	89		
Statistics	90	Troubleshooting	121
Configuration - Extender Mode - Access Point	91	Wireless Basics	125
Settings	91	What is Wireless?.....	126
Wireless	92	Tips.....	128
Network.....	95	Wireless Modes.....	129
Home	96	Networking Basics	130
DIR-879	97	Check your IP address.....	130
Connected Clients	98	Statically Assign an IP address	131
Management.....	99	Wireless Security	132
Time & Schedule	99	What is WPA?	132
Time	99		
Schedule	100	Technical Specifications	133
System Log.....	101	Regulatory Statements	134
Admin	103		
System	104		
Upgrade	105		
Connect a Wireless Client to your Router	106		
WPS Button	106		
Windows® 10	107		
Windows® 8.....	109		

Package Contents



DIR-879 AC1900 Wi-Fi Router



Ethernet Cable



Power Adapter



Wi-Fi Configuration Card



Wall-Mount Hardware

If any of the above items are missing, please contact your reseller.

Note: Using a power supply with a different voltage rating than the one included with the DIR-879 will cause damage and void the warranty for this product.

System Requirements

Network Requirements	<ul style="list-style-type: none">• An Ethernet-based cable or DSL modem• IEEE 802.11 ac/n/g/b/a wireless clients• 10/100 Ethernet
Web-based Configuration Utility Requirements	<p>Computer with the following:</p> <ul style="list-style-type: none">• Windows®, Macintosh, or Linux-based operating system• An installed Ethernet adapter <p>Browser Requirements:</p> <ul style="list-style-type: none">• Internet Explorer 11 or higher• Firefox 20 or higher• Safari 7 or higher• Chrome 25 or higher <p>Windows® Users: Make sure you have the latest version of Java installed. Visit www.java.com to download the latest version.</p>
QRS Mobile Requirements	<ul style="list-style-type: none">• iPhone®/iPad®/iPod Touch® (iOS 7.0 or higher)• Android™ device (2.3.3 or higher)

Introduction

The D-Link DIR-879 AC1900 Wi-Fi Router shares your Internet connection over a blazing-fast Gigabit Wireless AC connection of up to 1900 Mbps (Up to 1300 Mbps 5 GHz Wireless AC and up to 600 Mbps 2.4 GHz Wireless N)¹, using advanced AC beamforming technology to maximize the speed and range of your wireless signal. Equipped with one Gigabit WAN/Internet port and four Gigabit ports to provide speeds up to 10x faster than standard 10/100 ports, the DIR-879 creates the best networking experience to date. With the addition of advanced Quality of Service (QoS), data streams are separated, which helps organize and prioritize your network traffic so your computers, game consoles, 3D/4K video streaming, gaming, and VoIP calls run smoother over both your wired and wireless network.

The DIR-879 features the strongest and most sensitive wireless radio we've ever built, offering four times the power of a typical wireless router², letting you blanket large areas or multi-story buildings with Wi-Fi. The DIR-879's superior design allows you to enjoy full motion, high definition video calls on your mobile device while moving around. The DIR-879 prepares your home to become a Connected Home by bringing Wi-Fi to places your old signal can't reach. A stronger Wi-Fi signal means you can install more wireless surveillance cameras, baby monitors, sensors, and alarms in the places where you need them.

Featuring a 3x4 MIMO antenna configuration, the DIR-879 offers better data rates, fewer dead-spots, more coverage, and higher reliability. Built with AC SmartBeam technology, the DIR-879's intelligent radios will direct wireless signals to exactly where they are needed. Operating exclusively in the 5 GHz band, the DIR-879's 802.11ac wireless connections avoid crowded the 2.4 GHz band traffic, allowing you faster speeds while still maintaining backwards compatibility with older 802.11n/g/b devices.

The DIR-879's Smart Connect Technology makes connecting to wireless networks easy by eliminating the confusion of multiple networks. Ever since the introduction of 5 GHz multi-band wireless technology, users have had to guess whether the 5 GHz or 2.4 GHz band network would provide them with better range and speed. Smart Connect simplifies this by only presenting a single wireless network for the user to connect to. Behind the scenes, when a connection is initiated, the DIR-879's advanced algorithms determine the best band for your device to connect to, automatically distributing devices to the optimal speed and band, thereby ensuring a faster, more reliable, and hassle-free experience for all of your users and devices.

Equipped with an easily accessible mode switch, the versatile DIR-879 can assist you in solving your unique networking challenges. In router mode, the DIR-879 operates as a traditional router, sharing your Internet connection. In extender mode³, the DIR-879 connects and works with your existing networking equipment to extend the range and enhance the capabilities

of your home or office network. This means you can bring Wi-Fi to places where your current signal doesn't reach, letting you move from room to room, office to office, floor to floor, or yard to yard without losing signal. Enjoy Wi-Fi on your porch, balcony, next to your pool, breakroom, the far end of your office, or in your basement. The DIR-879's extender mode prepares your home to become a Connected Home by allowing you to install more wireless surveillance cameras, baby monitors, sensors, and alarms in the places where you need them.

D-Link Intelligent QoS Technology helps to increase network efficiency by analyzing network traffic and prioritizing it in order of importance. This way, two-way video, voice chat, and online gaming take priority over background network traffic such as a file downloads, ensuring you have optimal network performance.

The DIR-879 supports the latest wireless security features to help prevent unauthorized access, be it from over a wireless network or the Internet. Support for WPA™ and WPA2™ standards ensure that you will be able to use the best possible encryption regardless of your client devices. In addition, this router is equipped with a dual-active firewall (SPI and NAT) to prevent potential attacks over the Internet.

- 1 Maximum wireless signal rate derived from IEEE Standard 802.11a, 802.11g, 802.11n and 802.11ac specifications. Actual data throughput will vary. Network conditions and environmental factors, including volume of network traffic, building materials and construction, and network overhead, lower actual data throughput rate. Environmental conditions will adversely affect wireless signal range.
- 2 Determined by FCC regulation. Maximum wireless transmission power output is subject to regional radio frequency guidelines.
- 3 Extender Mode Access Point functionality available at launch, additional functionality available via firmware update in Q3 2016.

Features

- **Superior Wireless Networking** - The DIR-879 provides Gigabit wireless speeds of up to a combined 1900 Mbps (1300 Mbps 802.11ac 5 GHz, plus 600 Mbps 802.11n 2.4 GHz)¹. This capability rivals wired connections, allowing users to participate in real-time activities online, such as HD video communication, online gaming, and use mobile devices from anywhere in your home while still offering full 802.11n/g/b backward compatibility.
- **Extreme Wired LAN and WAN Networking** - With four 10/100/1000 Gigabit Ethernet LAN ports, and a 10/100/1000 Gigabit Ethernet WAN port, the DIR-879 has an enormous amount of bandwidth to take full advantage of the highest speed broadband connections available. Powered by a 1.0 GHz Dual Core CPU, the DIR-879 has the brains and the power to simultaneously stream multiple HD videos to set top boxes and mobile devices, participate in online gaming with consoles or PCs, run a cloud-enabled home surveillance system, and copy massive files without slowdowns, lag, or stuttering.
- **Smart Connect** - Creates a 'single' wireless network for your devices to connect to. Behind the scenes, the DIR-879 automatically determines whether to connect a device to the 2.4 or 5 GHz band, thereby providing the best speed and range for each device and optimally distributing devices to each network.
- **Advanced Firewall Features** - The web-based user interface displays a number of advanced network management features. Easily apply content filtering based on MAC address, URL, and/or domain name. Schedule these filters to be active on certain days or for a duration of hours or minutes.
- **Secure Multiple/Concurrent Sessions** - The DIR-879 can pass through VPN sessions. It supports multiple and concurrent IPsec and PPTP sessions, so users behind the DIR-879 can securely access corporate networks.
- **User-friendly Setup Wizard** - Through its easy-to-use web-based user interface or QRS Mobile (Quick Router Setup) App, the DIR-879 lets you quickly configure and secure your router to your specific settings in minutes.
- **Router or Extender Mode** - With the flick of a switch, you can easily set up your DIR-879 to operate as the core device of your network in Router Mode, or add your DIR-879 to an existing network using Extender Mode using Ethernet.²

¹ Maximum wireless signal rate derived from IEEE Standard 802.11a, 802.11g, 802.11n and 802.11ac specifications. Actual data throughput will vary. Network conditions and environmental factors, including volume of network traffic, building materials and construction, and network overhead, lower actual data throughput rate. Environmental conditions will adversely affect wireless signal range.

² Extender Mode Access Point functionality available at launch, additional functionality available via firmware update in Q3 2016.

Hardware Overview

LED Indicator

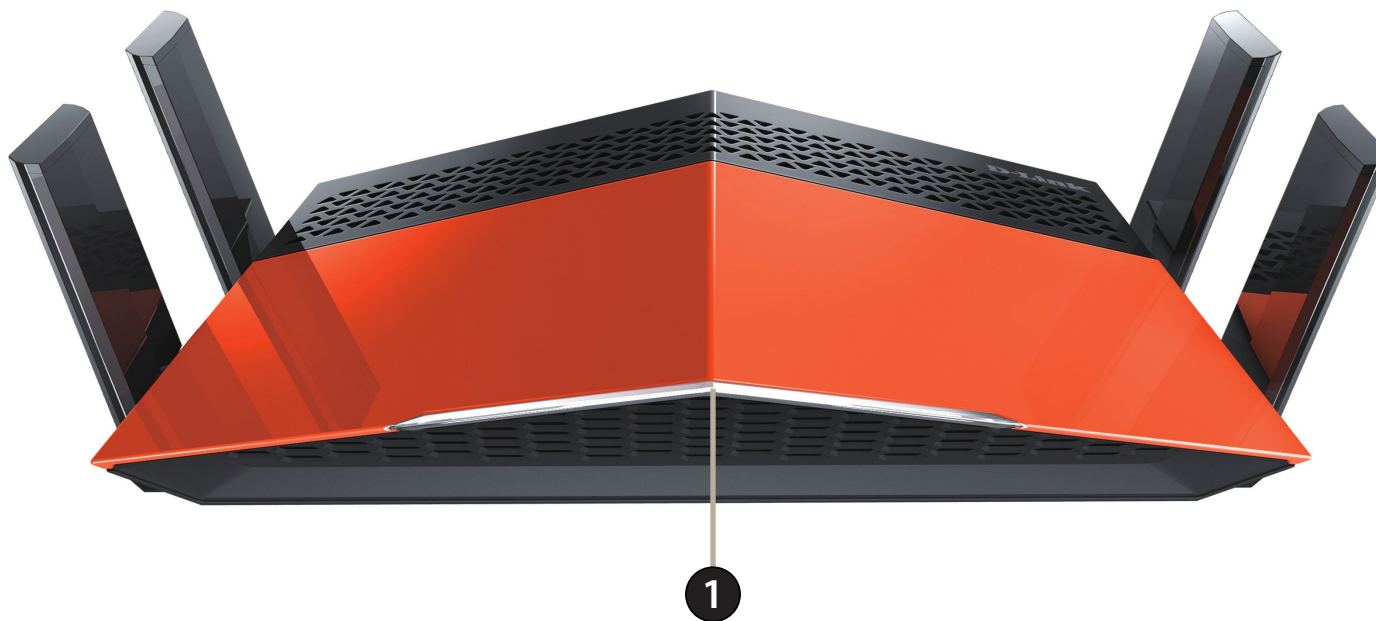

1	Power LED	Solid White	A solid white light indicates that the device is powered on and healthy.
		Solid Orange	A solid orange light indicates that the device is booting or undergoing a factory reset.
		Blinking Orange	A blinking orange light indicates that the device is in recovery mode.
		Blinking White	A blinking white light indicates that WPS client search mode is active.

Hardware Overview

Back Panel

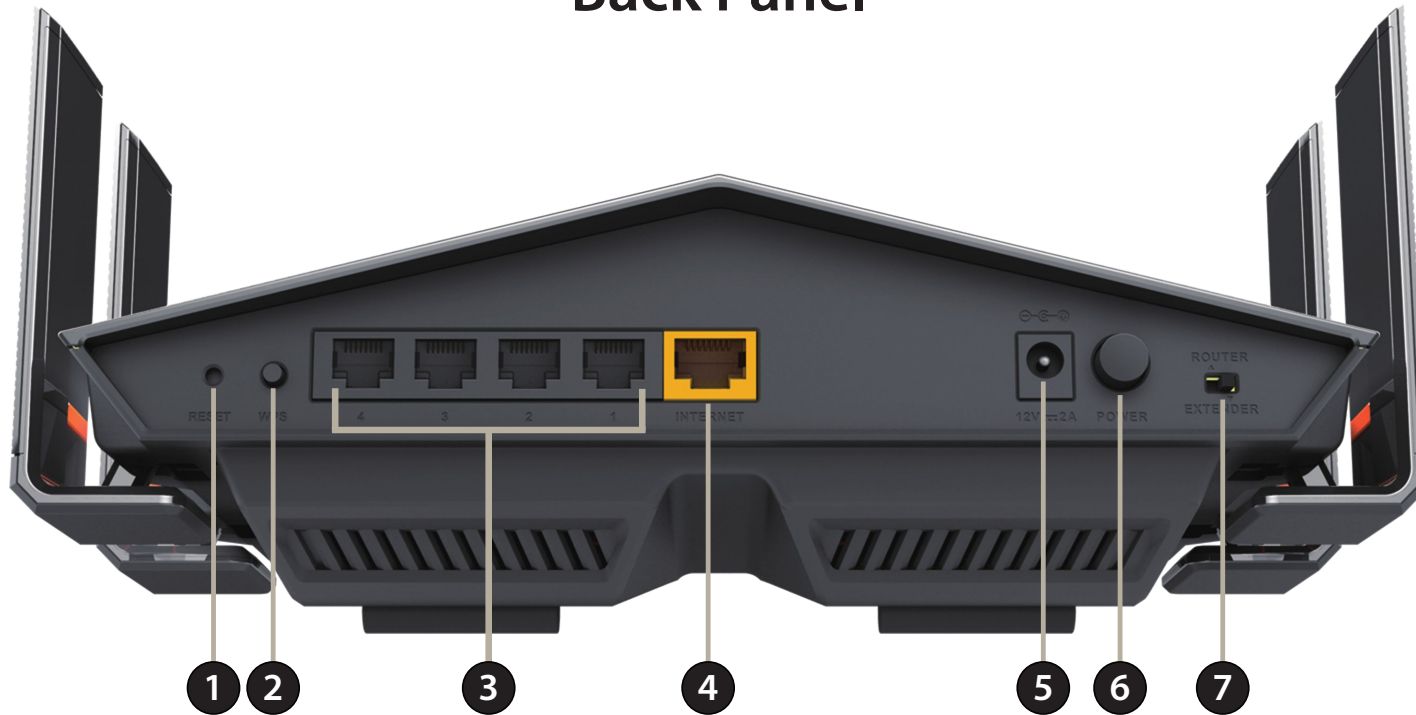

1	Reset Button	To reset the device to its factory default settings, use a paper clip press and hold the reset button for 3 seconds.
2	WPS	Press to start the WPS process and automatically create a secure connection to a WPS client.
3	LAN Ports (1-4)	Connect 10/100/1000 Ethernet devices such as computers, switches, storage (NAS) devices, and game consoles.
4	Internet Port	Using an Ethernet cable, connect your broadband modem to this port.
5	Power Connector	Connector for the supplied power adapter.
6	Power Button	Press the power button to power the DIR-879 on and off.
7	Mode Switch	Select between Router and Extender modes. To change modes, move the switch to the desired position and after 5 seconds the router will reboot into the desired mode. Router is the default mode. Note: Extender Mode Access Point functionality available at launch, additional functionality available via firmware update in Q3 2016.

Operation Modes

The mode switch lets you choose how the DIR-879 operates. Select either **Router Mode** or **Extender Mode**.

- **Router Mode** shares your Internet connection. This is the factory default setting suitable for most users.
- **Extender Mode** extends your existing network.

Refer to the following pages for information on the DIR-879's operation modes. This information includes usage scenarios, cable diagrams, and network configuration information.



Note: Determine your desired type of operation and adjust the mode switch before you begin your installation. If the mode switch is adjusted while powered on, the DIR-879 will reboot into the new mode after five seconds.

Note: Extender Mode Access Point functionality available at launch, additional functionality available via firmware update in Q3 2016.

Router Mode

In **Router Mode**, the DIR-879 AC1900 Wi-Fi Router operates as the central device of your network. This is the most common type of installation and is the factory default mode switch setting suitable for most users. The DIR-879 connects to your cable modem, DSL modem, or other Internet source and shares your Internet connection with your wired and wireless devices.

Create a Home Network (Router Mode)

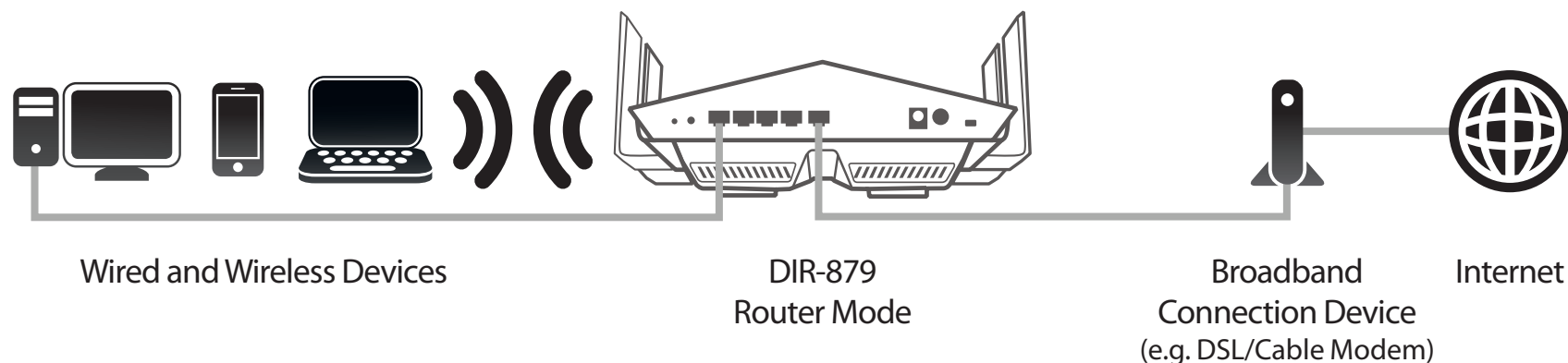

Use this mode for:

- Setting up a network for the first time.
- Replacing an existing router or network equipment.
- Adding a router to share a broadband connection which was previously connected to a single device.

Place your DIR-879 near your Broadband Internet Connection Device (e.g. DSL/Cable Modem) and connect via Ethernet cable.

Extender Mode

What is a Wireless Extender?

In **Extender Mode**, the DIR-879 AC1900 Wi-Fi Router operates in conjunction with your existing networking equipment to provide Wi-Fi for parts of your home or office that may have poor or no reception. Use this mode with an existing router which is sharing your Internet connection. Place the DIR-879 in an area where you wish to get Wi-Fi, but is reachable by Ethernet cables or Wireless signals from your uplink network.

Create a Wireless Network Using Ethernet (Access Point Mode)

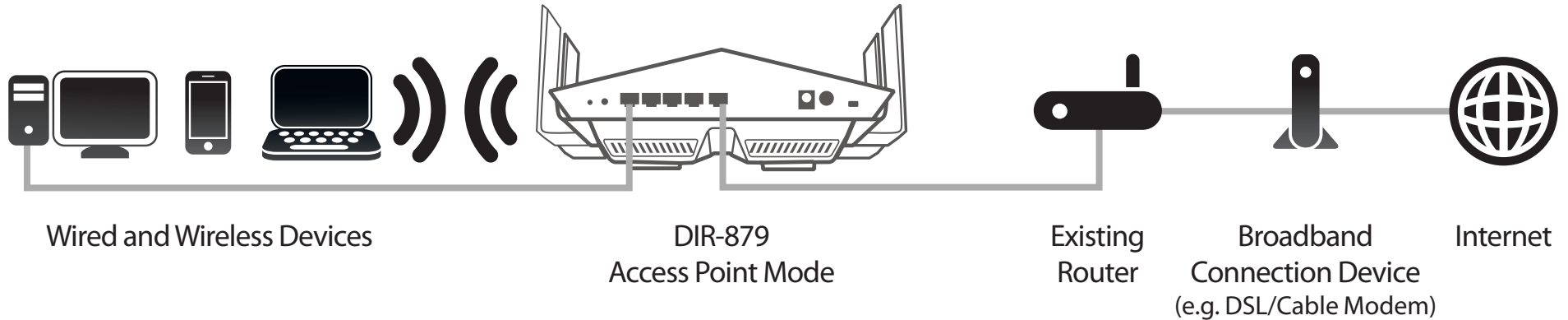

Extend Your Wireless Network Using Wi-Fi (Extender Mode)

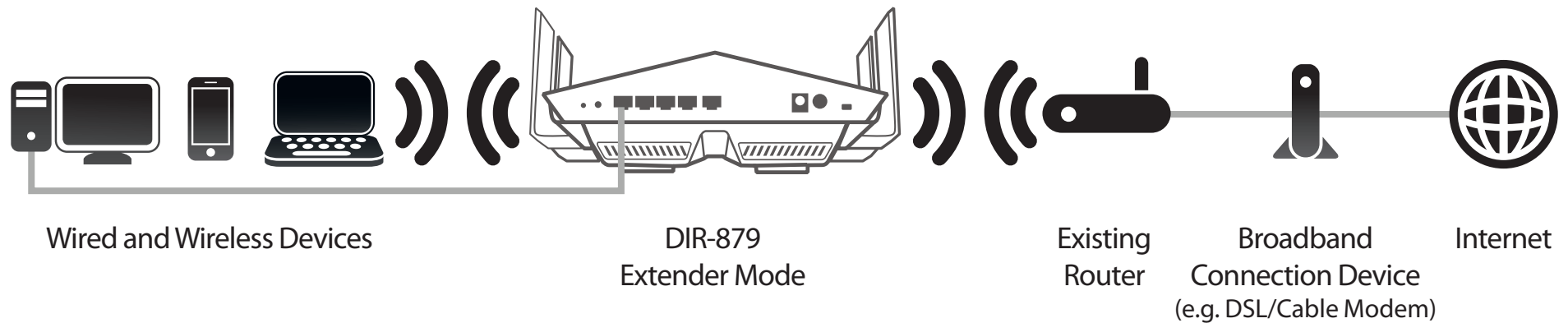

Note: Extend Your Wireless Network using Wi-Fi (Extender Mode) available via firmware update in Q2 2016.

Access Point

Create a Wireless Network using Ethernet

The DIR-879 operates as an Access Point when the mode switch is in the **Extender** position and an Ethernet cable is connected to the Internet Port from an uplink network. When configured as an Access Point, the DIR-879 connects your wireless devices together, but does not provide routing functionality. It also allows a connected wired devices to connect to your other devices wirelessly. This can be useful if you already have an existing Internet router that does not have built-in wireless capabilities. The DIR-879 creates a new wireless network and devices connected via Wi-Fi and LAN ports obtain IP addresses from the existing router. Use a Gigabit capable Ethernet connection where possible to ensure the best networking experience.

Create a Wireless Network using Ethernet (Extender Mode)

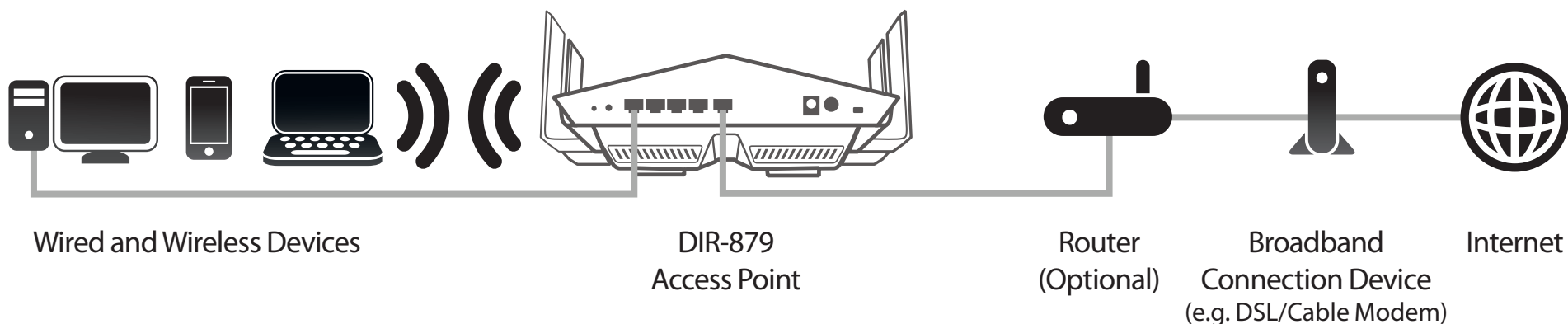

Use this mode for:

- Extending your current network.
- Bringing Wi-Fi to an area it doesn't currently reach.

Place your DIR-879 near the area you wish to bring Wi-Fi to and connect via Ethernet cable to your uplink network.

Note: Extending network to desired location via Ethernet may require purchase of additional cable.

Extender

Create a Wireless Network using Wi-Fi

The DIR-879 operates as an Extender when the mode switch is in the **Extender** position and the DIR-879 is connected wirelessly to an uplink network. The DIR-879 creates a new wireless network and devices connected via Wi-Fi and LAN ports obtain IP addresses from the existing router. Repeating a wireless signal reduces the total available amount of wireless bandwidth.

Extend Your Wireless Network Using Wi-Fi (Extender Mode)

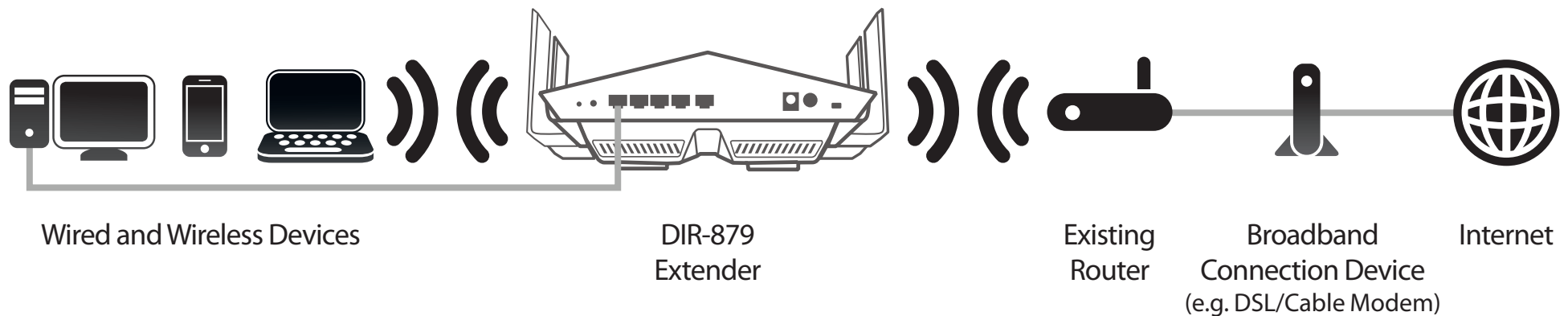

Use this mode for:

- Extending your current network.
- Bringing Wi-Fi to an area it doesn't currently reach.
- Providing better signal for parts of your home or office that may have poor reception.
- Connecting devices which do not have a built-in wireless card, such as some smart TVs, game consoles, or DVRs.
- Networking areas where cables can't reach.

Place your DIR-879 near the area you wish to bring Wi-Fi to and connect via Wi-Fi to your uplink network.

Note: Extend Your Wireless Network using Wi-Fi (Repeater Mode) available via firmware update in Q3 2016.

Installation

This section will walk you through the installation process. Placement of the router is very important. Do not place the router in an enclosed area such as a closet, cabinet, attic, or garage.

Before you Begin

- Configure the router with the computer that was last connected directly to your Internet connection. Verify that it is connected to the Internet before connecting additional devices.
- If your ISP provided you with a modem/router combo, you will need to set it to “bridge” mode so the router can work properly. Please contact your ISP or refer to the user manual for your modem/router device.
- You can only use the Ethernet port on your modem. If you were using the USB connection before using the router, then you must turn off your modem, disconnect the USB cable and connect an Ethernet cable to the Internet port on the router, and then turn the modem back on. In some cases, you may need to call your Internet Service Provider (ISP) to change connection types (USB to Ethernet).
- If connecting to a DSL modem, make sure to have your DSL service information provided by your Internet Service Provider handy. This information is likely to include your DSL account's Username and Password. Your ISP may also supply you with additional WAN configuration settings which might be necessary to establish a connection.
- If you are connecting a considerable amount of networking equipment, it may be a good idea to take the time to label each cable or take a picture of your existing setup before making any changes.
- If you have DSL and are connecting via PPPoE, make sure you disable or uninstall any PPPoE software such as WinPoET, BroadJump, or EnterNet 300 from your computer or you will not be able to connect to the Internet.
- If you are using this device to extend the range of your existing wireless network, you may need to use trial and error to determine an acceptable placement location.

Wireless Installation Considerations

The D-Link wireless router lets you access your network using a wireless connection from virtually anywhere within the operating range of your wireless network. Keep in mind that the number, thickness and location of walls, ceilings, or other objects that the wireless signals must pass through may limit the range. Typical ranges vary depending on the types of materials and background RF (radio frequency) noise in your home or business. The key to maximizing wireless range is to follow these basic guidelines:

1. Keep the number of walls and ceilings between the D-Link router and other network devices to a minimum - each wall or ceiling can reduce your adapter's range from 3-90 feet (1-30 meters.) Position your devices so that the number of walls or ceilings is minimized.
2. Be aware of the direct line between network devices. A wall that is 1.5 feet thick (0.5 meters), at a 45-degree angle appears to be almost 3 feet (1 meter) thick. At a 2-degree angle it looks over 42 feet (14 meters) thick! Position devices so that the signal will travel straight through a wall or ceiling (instead of at an angle) for better reception.
3. Building materials make a difference. A solid metal door or aluminum studs may have a negative effect on range. Try to position access points, wireless routers, and computers so that the signal passes through drywall or open doorways. Materials and objects such as glass, steel, metal, walls with insulation, water (fish tanks), mirrors, file cabinets, brick, and concrete will degrade your wireless signal.
4. Keep your product away (at least 3-6 feet or 1-2 meters) from electrical devices or appliances that generate RF noise.
5. If you are using 2.4 GHz cordless phones or X-10 (wireless products such as ceiling fans, lights, and home security systems), your wireless connection may degrade dramatically or drop completely. Make sure your 2.4 GHz phone base is as far away from your wireless devices as possible. The base transmits a signal even if the phone is not in use.

Antenna Setup

The DIR-879 is designed to give you the fastest, most stable network connection possible. In order to maximize performance, fully extend the antennas to provide optimal wireless coverage. Keep the router in an open area for better wireless coverage.

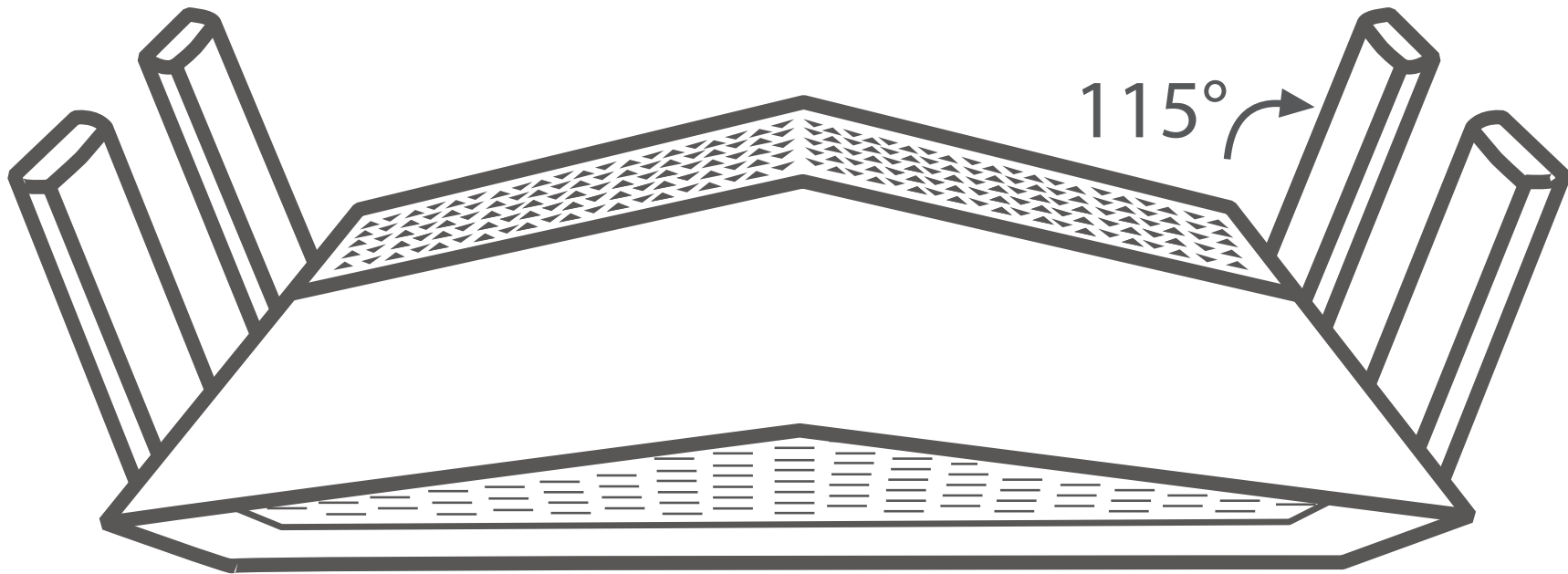

Hardware Setup

Router Mode

1. Inspect the mode switch to ensure that it is in the factory default **ROUTER** position. Adjust the switch if necessary.

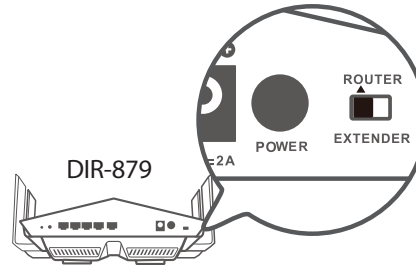

2. Position your DIR-879 near your Internet-connected modem. Place it in an open area for better wireless coverage.



3. Turn off and unplug the power and Ethernet cable to your cable or DSL broadband modem. This is required. In some cases, you may need to turn it off for up to five minutes.



4. Use the included Ethernet cable to connect your modem to the yellow port labeled **INTERNET** on the router.



5. Turn on or plug your modem back in and wait approximately one minute before proceeding onward.



6. Connect the supplied power adapter to the router and a power outlet, press the power button, and wait approximately one minute until the LED indicator on the front of the device changes from orange to solid white.

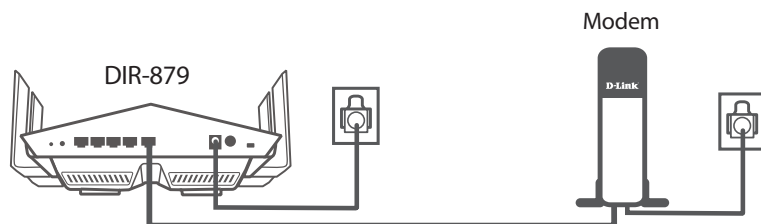

Note: This unit is to be used with power supply model DA-60N12.

7. If you are configuring the DIR-879 wirelessly from a PC, connect to a Wi-Fi network printed on the included Wi-Fi Configuration Card. You can also find the Wi-Fi network names and passwords printed on the label attached to the bottom your router.

If you are configuring the DIR-879 from a PC with a wired Ethernet connection, plug one end of an Ethernet cable into the port labeled 1 on the back of the router, and the other end into the Ethernet port on your computer.

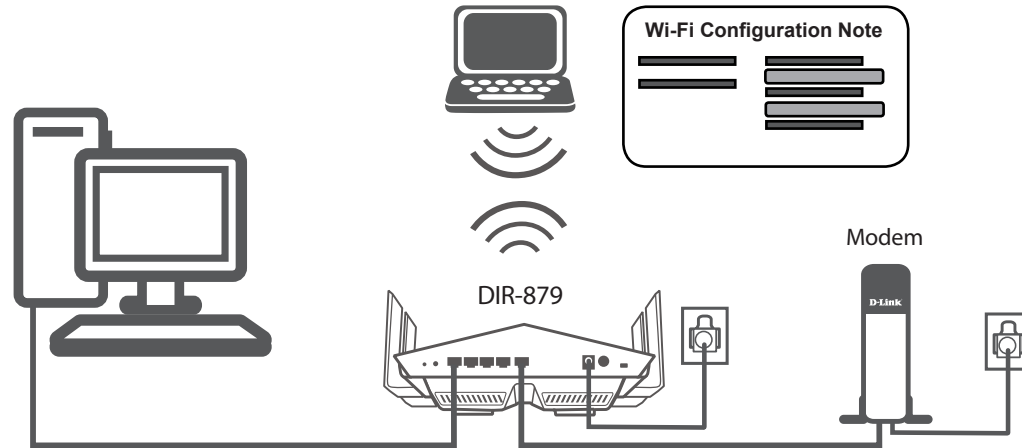

8. If you are connecting to a broadband service that uses a dynamic connection (not PPPoE), you may be online already. Try opening a web browser and connecting to a website. If the website does not load, proceed to **Getting Started on page 21**.

Hardware Setup

Extender - Access Point Mode

1. Inspect the mode switch to ensure that it is in **EXTENDER** position. Adjust the switch if necessary.

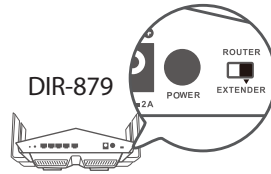

2. Position your DIR-879 near where you wish to extend Wi-Fi to. Place it in an open area for better wireless coverage.

DIR-879



3. Connect an Ethernet cable from your uplink network to the **INTERNET** port on the back of the DIR-879.

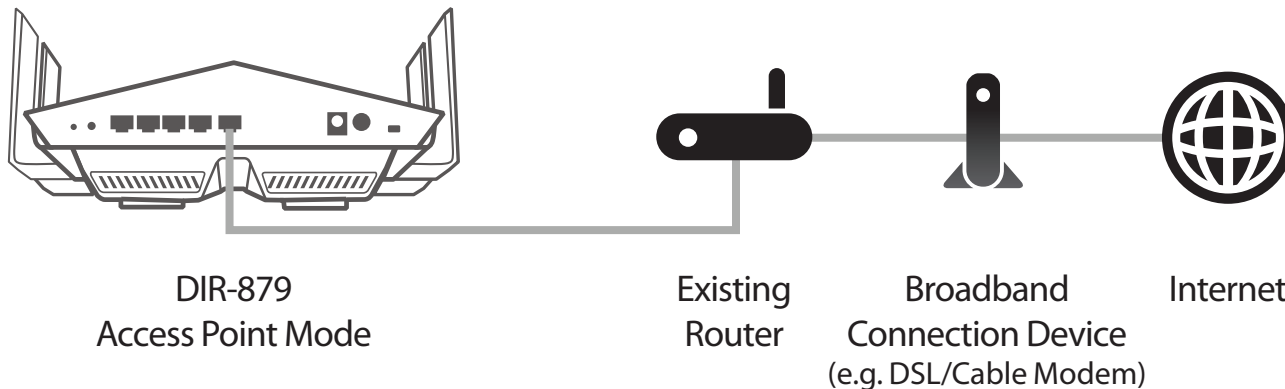

Note: Extending network to desired your location via Ethernet may require the purchase of additional cable. Maximum CAT5e cable length is limited to 100 meters. Use a Gigabit-capable Ethernet connection where possible to ensure the best networking experience.

4. Connect the supplied power adapter to the router and a power outlet, press the power button, and wait approximately one minute until the LED indicator on the front of the device changes from orange to solid white.

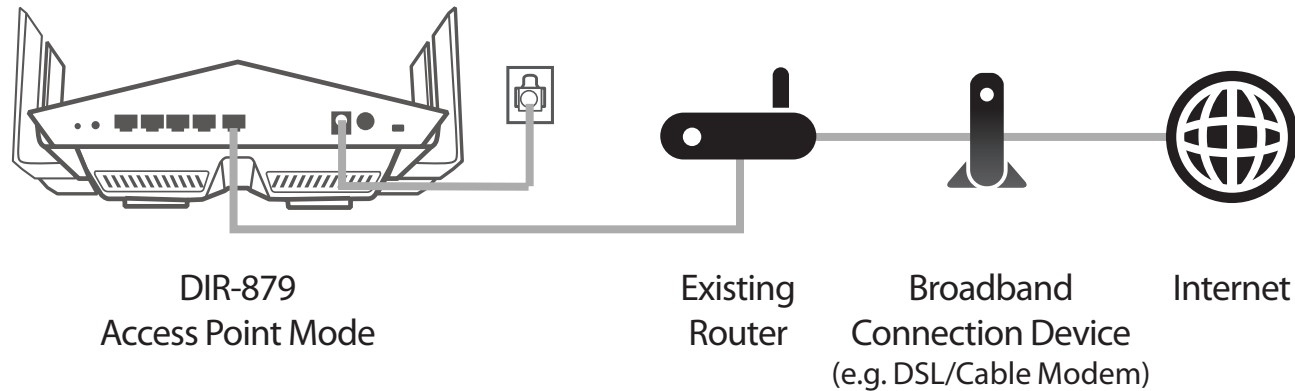

Note: This unit is to be used with power supply model DA-60N12.

5. Connect wired devices to the LAN ports on your DIR-879. Connect wireless devices to the Wi-Fi network printed on the included Wi-Fi Configuration Card. You can also find the Wi-Fi network names and passwords printed on the label attached to the bottom your DIR-879.

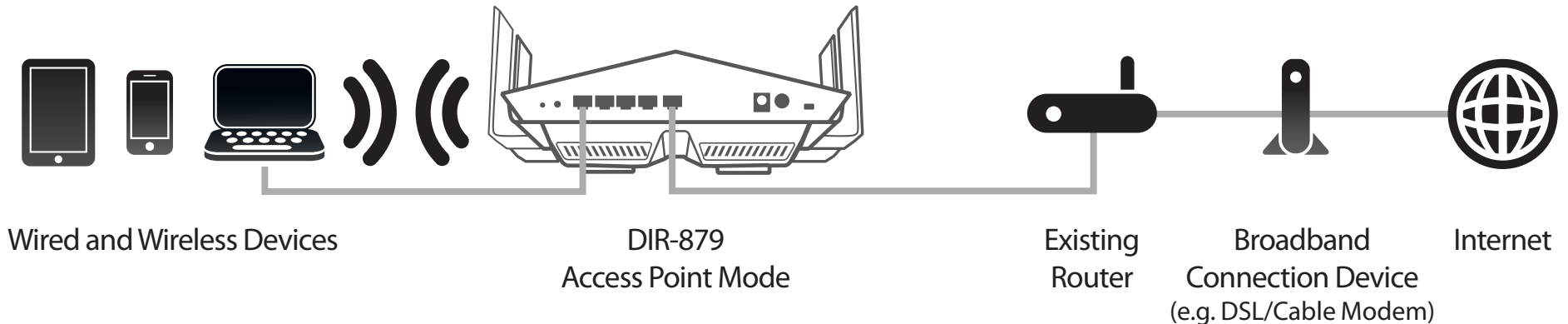

8. No further configuration is necessary, but if you wish to adjust the default settings, proceed to **Access Point - Extender Mode on page 31**.

Getting Started

Router Mode

There are several different ways you can configure your router to connect to the Internet and connect to your clients:

- **QRS Mobile App** - Use your Android device, iPhone, iPad, or iPod touch to configure your router. Refer to page 22.
- **D-Link Setup Wizard** - This wizard will launch when you log into the router for the first time. Refer to page 27.
- **Manual Setup** - Log into the router and manually configure your router. Refer to page 35.

QRS Mobile App

QRS Mobile app allows you to install and configure your router from your mobile device.

Note: The screenshots may be different depending on your mobile device's OS version.

Step 1

Search for the free **QRS Mobile** App on the iTunes Store or Google Play.



Step 2

Once your app is installed, you may now configure your router. Connect to the router wirelessly by going to your wireless utility on your device. Scan for the Wi-Fi name (SSID) as listed on the supplied info card. Select and then enter your Wi-Fi password.

D-Link Wi-Fi Configuration Card	
Default Configuration	Wi-Fi Name(SSID) 2.4GHz: _____
Wi-Fi Name (SSID): dlink-a8fa	Wi-Fi Password: _____
Wi-Fi Password: akbdj19368	Wi-Fi Name(SSID) 5GHz *: _____
	Wi-Fi Password *: _____
To configure your router, go to: http://dlinkrouter.local. Or http://192.168.0.1 Username: "Admin" Password: * (leave the field blank)	Your configuration Username: "Admin" Password: _____
	*For applicable models
	<small>DCMRP0W10010</small>

Step 3

Once you connect to the router, launch the QRS Mobile app from the Home screen of your device.

Note: The following steps show the Android interface of the QRS Mobile app. If you are using an iPhone, iPad, or iPod touch, the appearance may be different to that of the screenshots, but the process is the same.



Step 4

You will see the welcome screen. Tap **Start** to proceed, then enter your device password and tap **Log In**. Tap **Next** once the Operation Mode screen appears.

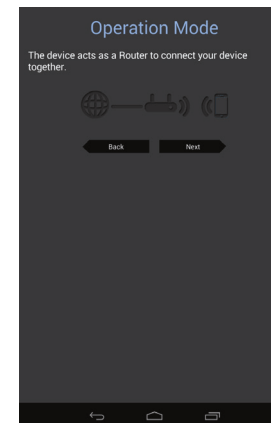
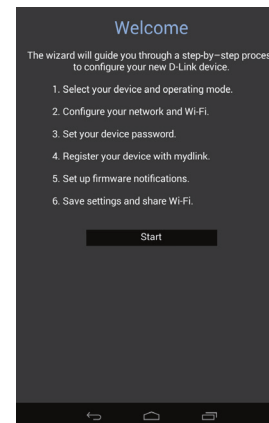

Step 5

At this point, please ensure that you the router is connected to a modem. Plug one end of the provided Ethernet cable into your DSL or cable modem, and plug the other end into the port marked INTERNET on the DIR-879. Tap **Next** to automatically detect your Internet connection and proceed to the next step.

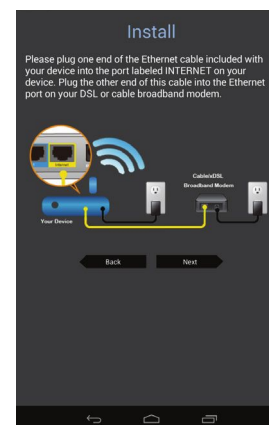

Step 6

You will be asked to configure your 2.4 GHz wireless network. Enter a network name (SSID) of your choice, or leave it unchanged to accept the default SSID.

Next, choose a Wi-Fi password of at least 8 characters. Any device trying to connect to the router wirelessly will need to enter this password the first time it connects.

Tap **Next** to configure your 5 GHz wireless network. When satisfied, tap **Next** to proceed.

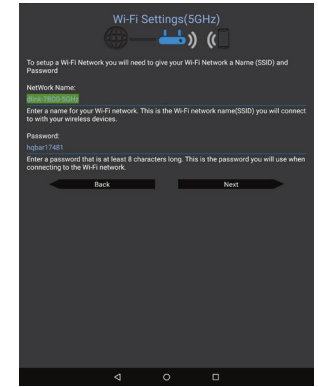
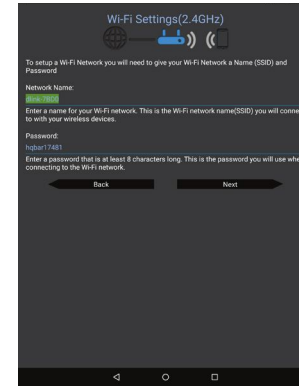

Step 7

Enter the administrator password of your choice. Unlike the Wi-Fi password, this password is only required when you need to configure the router. See **Configuration - Router Mode** on page 35 for details of when this password is used. Tap **Next** to proceed.

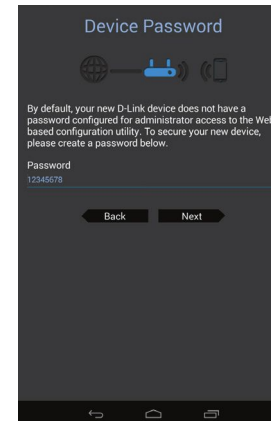

Step 8

If you wish to receive push notifications whenever a new firmware update is available, check the **Notify me when new firmware is available** box and tap **Next**.

Otherwise, just tap **Next** to proceed.

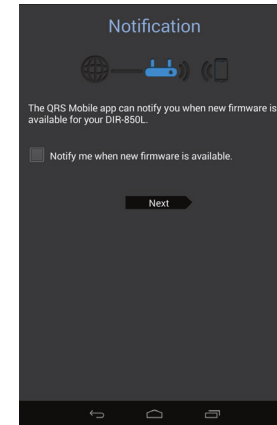

Step 9

You will be presented with a summary of your chosen settings. Tap **Save** to complete the setup.

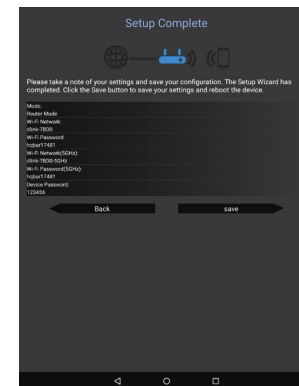

Congratulations, your device has been successfully configured! You can share this information by tapping **Share By E-mail**, or tap **Finish** to exit the app.

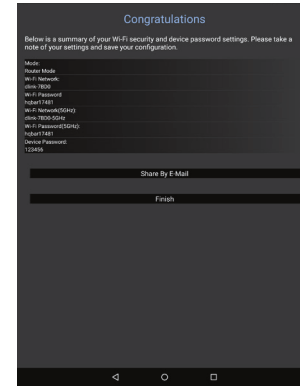

Setup Wizard

If this is your first time installing the router, open your web browser and enter **http://dlinkrouter.local/** in the address bar. Alternatively, enter the IP address of the router (default: **http://192.168.0.1**).

The wizard is designed to guide you through a step-by-step process to configure your new D-Link router and connect to the Internet.

Click **Next** to continue.

Please wait while your router detects your Internet connection type. If the router detects your Internet connection, you may need to enter your ISP information such as username and password.

If the router does not detect a valid Internet connection, a list of connection types to choose from will be displayed.

Select your Internet connection type (this information can be obtained from your Internet Service Provider) and click **Next** to continue.

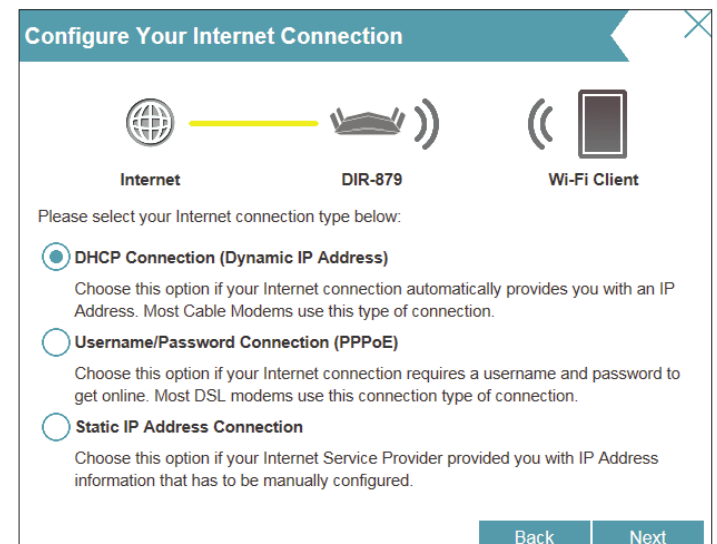
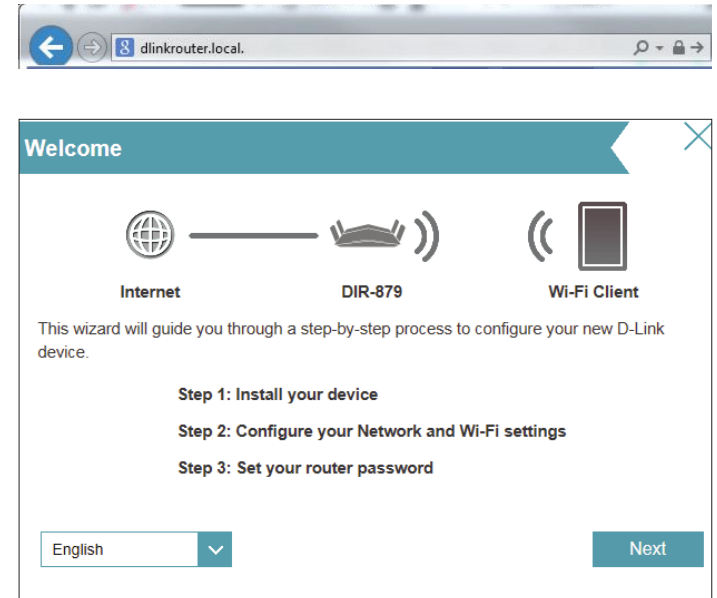

If the router detected or you selected **PPPoE**, enter your PPPoE username and password and click **Next** to continue.

Note: Make sure to remove your PPPoE software from your computer. The software is no longer needed and will not work through a router.

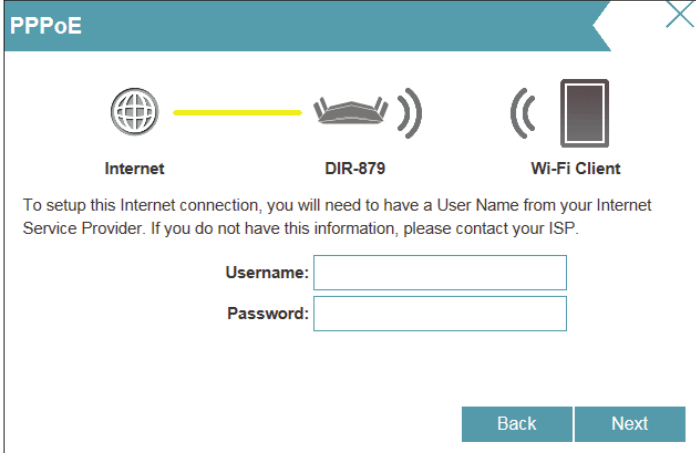

The screenshot shows the 'PPPoE' configuration screen. At the top, there is a teal header with the text 'PPPoE' and a close button (X). Below the header, there is a diagram showing 'Internet' (globe icon) connected to 'DIR-879' (router icon) which is connected to a 'Wi-Fi Client' (smartphone icon). Below the diagram, there is a text block: 'To setup this Internet connection, you will need to have a User Name from your Internet Service Provider. If you do not have this information, please contact your ISP.' Underneath this text are two input fields: 'Username:' and 'Password:'. At the bottom right, there are two buttons: 'Back' and 'Next'.

If the router detected or you selected **Static**, enter the IP and DNS settings supplied by your ISP. Click **Next** to continue.



The screenshot shows the 'Static IP' configuration screen. At the top, there is a teal header with the text 'Static IP' and a close button (X). Below the header, there is a diagram showing 'Internet' (globe icon) connected to 'DIR-879' (router icon) which is connected to a 'Wi-Fi Client' (smartphone icon). Below the diagram, there is a text block: 'To set up this connection you will need to have a complete list of IP information by your Internet Service Provider. If you have a Static IP connection and do not have this information, please contact your ISP.' Underneath this text are five input fields: 'IP Address:', 'Subnet Mask:', 'Gateway Address:', 'Primary DNS Address', and 'Secondary DNS Address'. At the bottom right, there are two buttons: 'Back' and 'Next'.

Create a Wi-Fi password (between 8-63 characters). Your wireless clients will need to have this passphrase or key entered to be able to connect to your wireless network.

Click **Next** to continue.

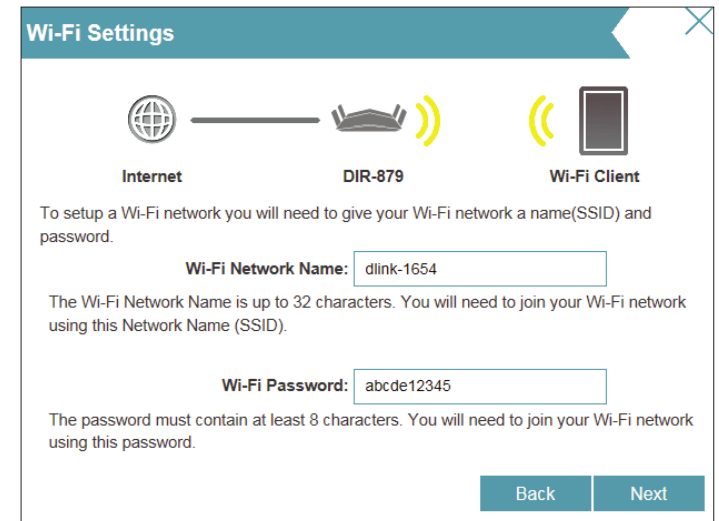

In order to secure the router, please enter a new password. You will be prompted for this password every time you want to use the router's web configuration utility. Click **Next** to continue.

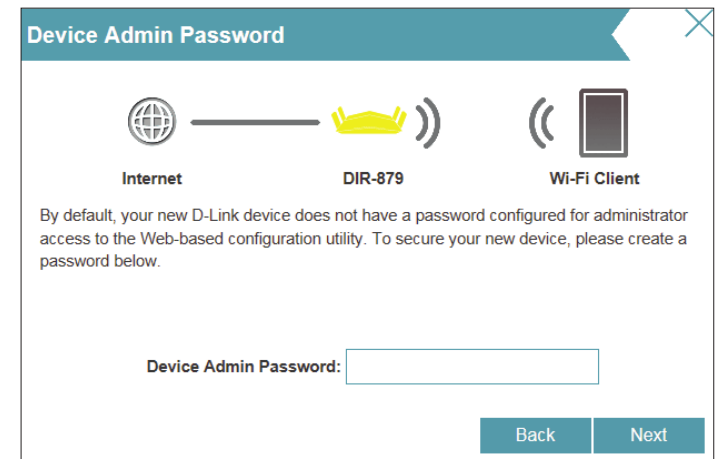

You will be presented with a summary of your settings. Click **Next** to finalize the settings or **Back** to make changes.

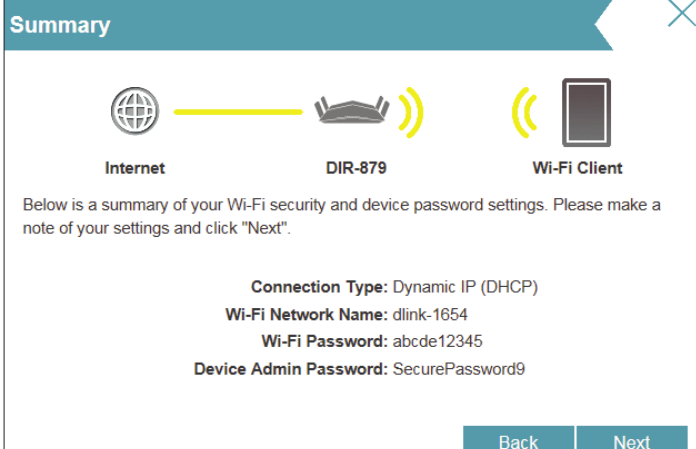

The Summary screen features a teal header with the word "Summary" and a close button. Below the header, three icons are arranged horizontally: a globe for "Internet", a router for "DIR-879", and a smartphone for "Wi-Fi Client". A yellow line connects the Internet and DIR-879 icons. Below the icons, a paragraph of text reads: "Below is a summary of your Wi-Fi security and device password settings. Please make a note of your settings and click 'Next'." The settings are listed as follows: "Connection Type: Dynamic IP (DHCP)", "Wi-Fi Network Name: dlink-1654", "Wi-Fi Password: abcde12345", and "Device Admin Password: SecurePassword9". At the bottom right, there are two buttons: "Back" and "Next".

At the end of the wizard, you will be presented with a final summary of your settings. Click **Finish** to close the wizard.



The Congratulations screen features a teal header with the word "Congratulations". Below the header, a paragraph of text reads: "Congratulations, your device has been configured. You can now connect to your Wi-Fi network by using the new Wi-Fi Network Name and Password you created." Below this text, three items are listed, each with a green checkmark icon to its left: "Connection Type: Dynamic IP (DHCP)", "Device Admin Password: SecurePassword9", and "Wi-Fi Network Name: dlink-1654" followed by "Wi-Fi Password: abcde12345". At the bottom right, there is a "Finish" button.

Getting Started

Access Point - Extender Mode

Once the DIR-879 has been properly set up as an Access Point in Extender Mode as detailed in Section 2 - Installation, no further configuration is necessary in most cases. You may connect wired devices using Ethernet cables or connect wireless devices using the default wireless credentials printed on the Wi-Fi Configuration card. For more information about connecting wireless devices, refer to **Connect a Wireless Client to your Router** on page 106.

If you want to make changes to the default Access Point settings, such as the wireless network names or passwords, or need to perform advanced configuration setup you can do so using the web configuration utility. The web configuration utility has two main sections.

- **D-Link Setup Wizard** - This wizard will launch when you log in for the first time if no Internet connection is detected. Refer to page 27.
- **Manual Setup** - Log in and manually configure your device. Refer to **Configuration - Extender Mode - Access Point** on page 90.

Setup Wizard

To access the setup utility for the DIR-879 Access Point in Extender mode on your PC, first connect to the DIR-879 using wired Ethernet cabling or wirelessly using the Wi-Fi name (SSID) and password located on your Wi-Fi Configuration Card. Then open a web browser and enter **http://dlinkrouter.local./** in your browser's URL field. You may also enter the IP address* of the DIR-879.

* By default the DIR-879 in extender mode will use DHCP to obtain an IP address from your uplink network. If you are using multiple DIR-879s or D-Link devices, go to **http://dlinkrouterxxxx.local./** as shown on the included Wi-Fi Configuration Card, with "xxxx" being the last four digits of the DIR-879's MAC address. The MAC address is also printed on the label on the bottom of the device.

The wizard is designed to guide you through a step-by-step process to configure your new D-Link router as an Access Point and connect to your network and the Internet.

Click **Next** to continue.

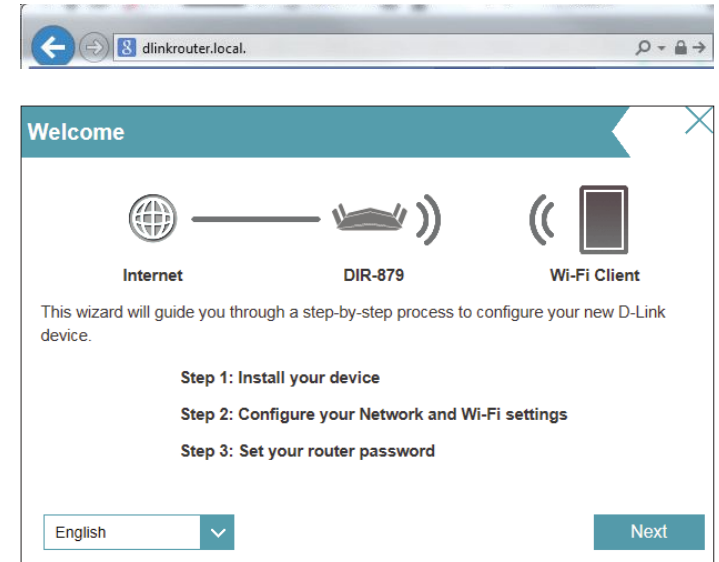

Create a Wi-Fi password (between 8-63 characters). Your wireless clients will need to have this passphrase or key entered to be able to connect to your wireless network.

Click **Next** to continue.

In order to secure the router, please enter a new password. You will be prompted for this password every time you want to use the router's web configuration utility. Click **Next** to continue.

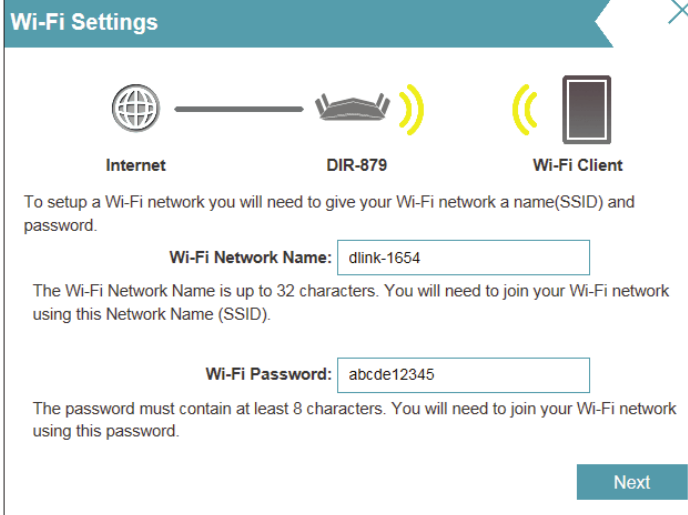

Wi-Fi Settings

Internet — DIR-879 — Wi-Fi Client

To setup a Wi-Fi network you will need to give your Wi-Fi network a name (SSID) and password.

Wi-Fi Network Name:

The Wi-Fi Network Name is up to 32 characters. You will need to join your Wi-Fi network using this Network Name (SSID).

Wi-Fi Password:

The password must contain at least 8 characters. You will need to join your Wi-Fi network using this password.

Next

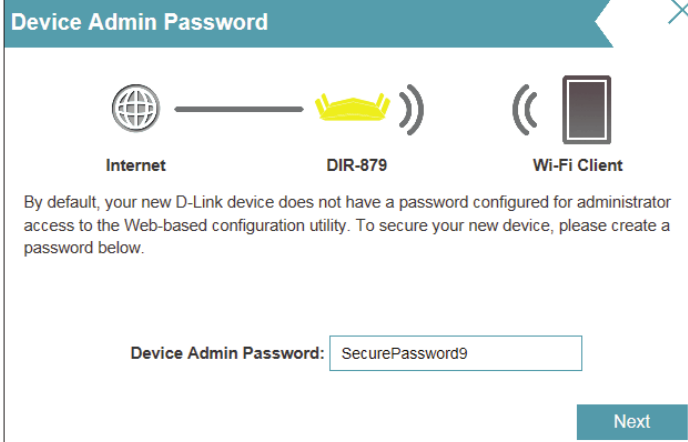

Device Admin Password

Internet — DIR-879 — Wi-Fi Client

By default, your new D-Link device does not have a password configured for administrator access to the Web-based configuration utility. To secure your new device, please create a password below.

Device Admin Password:

Next

You will be presented with a summary of your settings. Click **Next** to finalize the settings or **Back** to make changes.

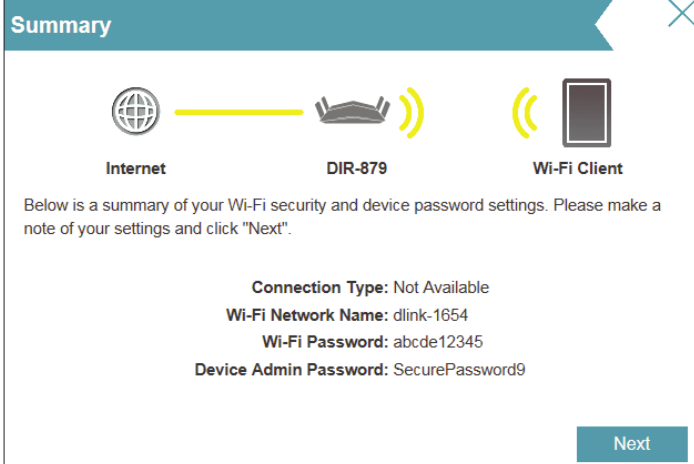

The Summary screen features a teal header with the word "Summary" and a close button in the top right. Below the header, there are three icons: a globe for "Internet", a router for "DIR-879", and a smartphone for "Wi-Fi Client". A yellow line connects the Internet and DIR-879 icons. Below the icons, a paragraph of text reads: "Below is a summary of your Wi-Fi security and device password settings. Please make a note of your settings and click 'Next'." The settings listed are: "Connection Type: Not Available", "Wi-Fi Network Name: dlink-1654", "Wi-Fi Password: abcde12345", and "Device Admin Password: SecurePassword9". A teal "Next" button is located in the bottom right corner.

At the end of the wizard, you will be presented with a final summary of your settings. Click **Finish** to close the wizard.



The Congratulations screen features a teal header with the word "Congratulations" and a close button in the top right. Below the header, a paragraph of text reads: "Congratulations, your device has been configured. You can now connect to your Wi-Fi network by using the new Wi-Fi Network Name and Password you created." Below this text, there are three rows of information, each with a green checkmark icon on the left. The first row shows a globe icon and the text "Connection Type: Not Available". The second row shows a cylinder icon and the text "Device Admin Password: SecurePassword9". The third row shows a smartphone icon and the text "Wi-Fi Network Name: dlink-1654" and "Wi-Fi Password: abcde12345". A teal "Finish" button is located in the bottom right corner.

Configuration - Router Mode

To access the configuration utility, open a web-browser such as Internet Explorer and enter **http://dlinkrouter.local/** or you may also connect by typing the IP address of the router (by default this is **http://192.168.0.1**) in the address bar.

Enter your password. If you previously followed the setup wizard, please use the admin password you entered during the wizard. Otherwise, leave the password blank. Click **Log In** to proceed.

Note: If you cannot remember your password and cannot log in, press the reset/wps button on the back of the device for longer than 10 seconds to restore the router to its default settings.

The router's home page will open displaying its current connection status.

The bar at the top of the page has quick access to Settings and Management functions. You may quickly jump back Home at any time.

Note: The system will automatically log out after a period of inactivity.

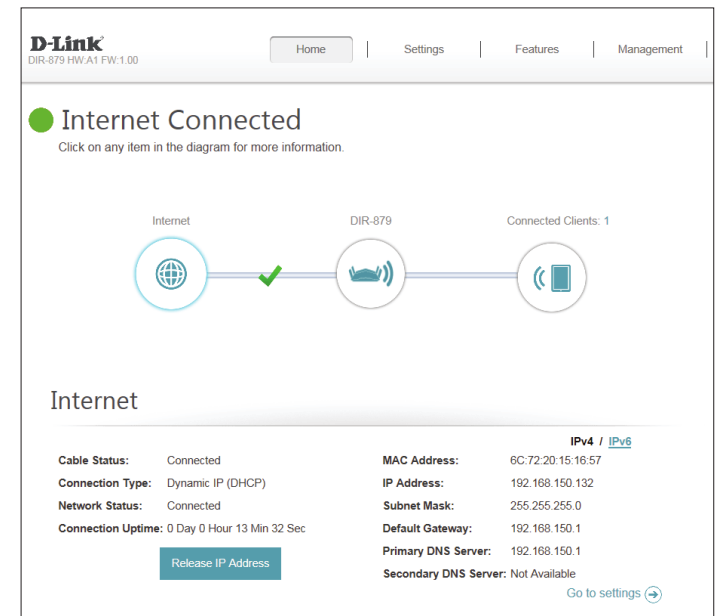
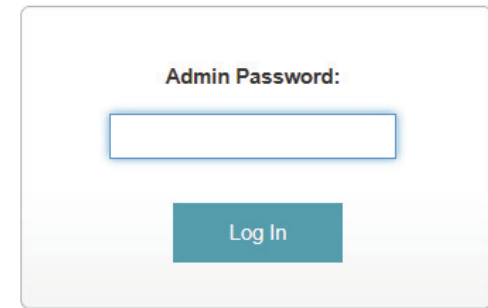
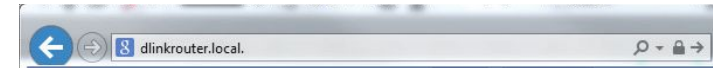

Home

The Home page displays the current status of the router in the form of an interactive diagram. You can click each icon to display information about each part of the network at the bottom of the screen. The menu bar at the top of the page will allow you to quickly navigate to other pages.

Internet

The Home page displays whether or not the router is currently connected to the Internet. If it is disconnected, click **Click to repair** to bring up the setup wizard, refer to page 27 for more information.

To bring up more details about your Internet connection, click on the **Internet** icon. Click **IPv4** or **IPv6** to see details of the IPv4 connection and IPv6 connection respectively.

Click **Release** to disconnect from the Internet. If you do this and wish to reconnect, click **Renew**.

To reconfigure the Internet settings, refer to page 39.

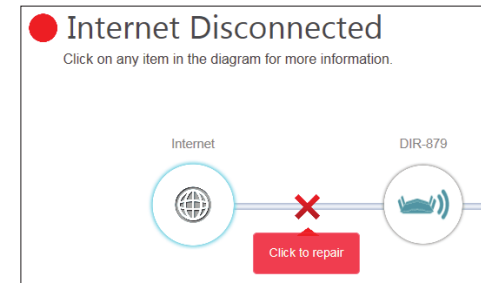

D-Link
DIR-879 HW:A1 FW:1.00

Home Settings Features Management

Internet Connected
Click on any item in the diagram for more information.

Internet DIR-879 Connected Clients: 1

Internet

[IPv4](#) / [IPv6](#)

Cable Status:	Connected	MAC Address:	6C:72:20:15:16:57
Connection Type:	Dynamic IP (DHCP)	IP Address:	192.168.150.132
Network Status:	Connected	Subnet Mask:	255.255.255.0
Connection Uptime:	0 Day 0 Hour 13 Min 32 Sec	Default Gateway:	192.168.150.1
		Primary DNS Server:	192.168.150.1
		Secondary DNS Server:	Not Available

Release IP Address

[Go to settings](#)

DIR-879

Click on the **DIR-879** icon to view details about the router and its wireless settings.

Here you can see the router's current Wi-Fi network name and password, as well as the router's MAC address, IPv4 address, and IPv6 address.

To reconfigure the network settings, either click **Go to settings** on the lower left, or click **Settings** (at the top of the page) and then **Network** on the menu that appears. For more information refer to page 70.

To reconfigure the wireless settings, either click **Go to settings**, on the lower right, or click **Settings** (at the top of the page) and then **Wireless** on the menu that appears. For more information refer to page 66.

The screenshot displays the D-Link DIR-879 web interface. At the top, there is a navigation bar with 'Home', 'Settings', 'Features', and 'Management' tabs. Below the navigation bar, a green circle indicates 'Internet Connected'. A network diagram shows 'Internet' connected to 'DIR-879', which is connected to 'Connected Clients: 1'. Below the diagram, the 'DIR-879' settings are shown, divided into 'IPv4 Network' and 'Wi-Fi' sections.

Section	Parameter	Value
IPv4 Network	MAC Address:	6C:72:20:15:16:54
	Router IP Address:	192.168.0.1
	Subnet Mask:	255.255.255.0
Wi-Fi	Status:	Enabled
	Wi-Fi Name (SSID):	dlink-1654
	Password:	abcde12345
	Go to settings	↔
IPv6 Network	Link-Local Address:	FE80::6E72:20FF:FE15:1654
	Router IPv6 Address:	/
	DHCP-PD:	Enabled
	Assigned Prefix:	Not Available
	Go to settings	↔

Connected Clients

Click on the **Connected Clients** icon to view details about the router and its wireless settings.

On this page you can see all the clients currently connected to the router, and their IP addresses.

To edit each client's settings, click the pencil icon on the client you want to edit.



Name: Enter a custom name for this client.

Vendor: Displays the vendor of the device.

MAC Address: Displays the MAC address of the device.

IP Address: Displays the current IP address of this client.

Reserve IP: Enable to reserve this IP address for this client.

IP Address (Reserved): Specify an IP address for the DIR-879's DHCP server to assign.

Parental Control: Allow or Block access to the router.

Click **Save** when you are done.

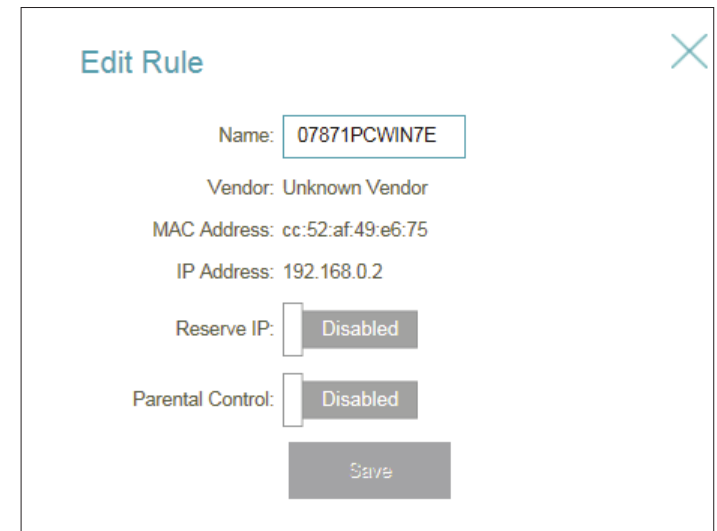

Settings Wizard

In the Settings menu on the bar on the top of the page, click **Wizard** to open the setup wizard. This is the same wizard that appears when you start the router for the first time. Refer to page 27 for details.

Internet

In the Settings menu on the bar on the top of the page, click **Internet** to see the Internet configuration options.

My Internet Connection Is: Choose your Internet connection type from the drop-down menu. You will be presented with the appropriate options for your connection type. Click **Advanced Settings...** to expand the list and see all of the options.

For **Dynamic IP (DHCP)** refer to page 40.

For **Static IP** refer to page 41.

For **PPPoE** refer to page 42.

For **PPTP** refer to page 44.

For **L2TP** refer to page 46.

For **DS-Lite** refer to page 48.

To configure an IPv6 connection, click the **IPv6** link. Refer to page 49.

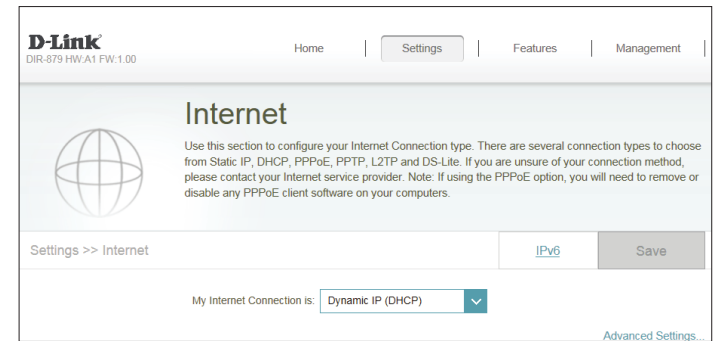

Dynamic IP (DHCP)

Select **Dynamic IP (DHCP)** to obtain IP address information automatically from your Internet Service Provider (ISP). Select this option if your ISP does not specify an IP address to use.

Advanced Settings

Host Name: The host name is optional but may be required by some ISPs. Leave it blank if you are not sure.

Primary DNS Server: Enter the primary DNS server IP address assigned by your ISP. This address is usually obtained automatically from your ISP.

Secondary DNS Server: Enter the secondary DNS server IP address assigned by your ISP. This address is usually obtained automatically from your ISP.

MTU: Maximum Transmission Unit - you may need to change the MTU for optimal performance with your ISP.

MAC Address Clone: The default MAC address is set to the Internet port's physical interface MAC address on the router. You can use the drop-down menu to replace the Internet port's MAC address with the MAC address of a connected client.

Click **Save** when you are done.

D-Link
DIR-879 HW v1.1 FW:1.00

Home | Settings | Features | Management

Internet

Use this section to configure your Internet Connection type. There are several connection types to choose from Static IP, DHCP, PPPoE, PPTP, L2TP and DS-Lite. If you are unsure of your connection method, please contact your Internet service provider. Note: If using the PPPoE option, you will need to remove or disable any PPPoE client software on your computers.

Settings >> Internet IPv6 Save

My Internet Connection is: Dynamic IP (DHCP)

[Advanced Settings](#)

Host Name:

Primary DNS Server:

Secondary DNS Server:

MTU: Auto

Mac Address Clone: << MAC Address

Static IP

Select **Static IP** if your IP information is provided by your Internet Service Provider (ISP).

IP Address: Enter the IP address provided by your ISP.

Subnet Mask: Enter the subnet mask provided by your ISP.

Default Gateway: Enter the default gateway address provided by your ISP.

Primary DNS Server: Enter the primary DNS server IP address assigned by your ISP.

Advanced Settings

Secondary DNS Server: Enter the secondary DNS server IP address assigned by your ISP.

MTU: Maximum Transmission Unit - you may need to change the MTU for optimal performance with your ISP.

MAC Address Clone: The default MAC address is set to the Internet port's physical interface MAC address on the router. You can use drop-down menu to replace the Internet port's MAC address with the MAC address of a connected client.

Click **Save** when you are done.

The screenshot shows the D-Link DIR-879 Internet configuration page. The page title is "Internet" and it includes a navigation bar with "Home", "Settings", "Features", and "Management". A globe icon is next to the title. Below the title is a brief instruction: "Use this section to configure your Internet Connection type. There are several connection types to choose from: Static IP, DHCP, PPPoE, PPTP, L2TP and DS-Lite. If you are unsure of your connection method, please contact your Internet service provider. Note: If using the PPPoE option, you will need to remove or disable any PPPoE client software on your computers." The page has a breadcrumb "Settings >> Internet" and a "Save" button. The "My Internet Connection is:" dropdown is set to "Static IP". Below this are input fields for "IP Address:", "Subnet Mask:", "Default Gateway:", and "Primary DNS Server:". An "Advanced Settings..." link is at the bottom right.

This screenshot shows the "Advanced Settings" section of the Internet configuration page. It contains three fields: "Secondary DNS Server:" with an input field, "MTU:" with a dropdown menu set to "Auto", and "Mac Address Clone:" with an input field and a dropdown menu set to "<< MAC Address".

PPPoE

Select **PPPoE** if your Internet connection requires you to enter a username and password. This information is provided by your Internet Service Provider (ISP).

Username: Enter the username provided by your ISP.

Password: Enter the password provided by your ISP.

Reconnect Mode: Select either **Always-on**, **On-Demand**, or **Manual**.

Maximum Idle Time: Enter a maximum idle time during which the Internet connection is maintained during inactivity. To disable this feature, enable Auto-reconnect.

Advanced Settings

Address Mode: Select **Static IP** if your ISP assigned you the IP address, subnet mask, gateway, and DNS server addresses. In most cases, select **Dynamic IP**.

Dynamic IP

IP Address: Enter the IP address provided by your ISP (Static IP only).

Service Name: Enter the ISP service name (optional).

Primary DNS Server: Enter the primary DNS server IP address assigned by your ISP.

Secondary DNS Server: Enter the secondary DNS server IP address assigned by your ISP.

MTU: Maximum Transmission Unit - you may need to change the MTU for optimal performance with your ISP. The recommended setting is **Auto**.

The screenshot shows the 'Internet' configuration page in the D-Link web interface. The 'My Internet Connection is:' dropdown is set to 'PPPoE'. Below it, there are input fields for 'Username:' and 'Password:'. The 'Reconnect Mode:' dropdown is set to 'On demand', and the 'Maximum Idle Time:' is set to '5 minutes'. There are 'IPv6' and 'Save' buttons. A note at the top explains that this section is for configuring the Internet Connection type, listing options like Static IP, DHCP, PPPoE, PPTP, L2TP, and DS-Lite. It also mentions that if using PPPoE, client software on computers may need to be removed or disabled.

The screenshot shows the 'Advanced Settings' section of the Internet configuration page. It includes dropdowns for 'Address Mode:' (set to 'Dynamic IP') and 'MTU:' (set to 'Auto'). There are input fields for 'Service Name:', 'Primary DNS Server:', and 'Secondary DNS Server:'. At the bottom, there is a 'Mac Address Clone:' field with a dropdown set to '<< MAC Address'.

MAC Address Clone: The default MAC address is set to the Internet port's physical interface MAC address on the router. You can use the drop-down menu to replace the Internet port's MAC address with the MAC address of a connected client.

Static IP

IP Address: Enter the IP address provided by your ISP (Static IP only).

Service Name: Enter the ISP service name (optional).

Primary DNS Server: Enter the primary DNS server IP address assigned by your ISP.

Secondary DNS Server: Enter the secondary DNS server IP address assigned by your ISP.

MTU: Maximum Transmission Unit - you may need to change the MTU for optimal performance with your ISP.

MAC Address Clone: The default MAC address is set to the Internet port's physical interface MAC address on the router. You can use the drop-down menu to replace the Internet port's MAC address with the MAC address of a connected client.

Click **Save** when you are done.

The screenshot shows a configuration form for Static IP. The fields are: Address Mode (dropdown menu set to 'Static IP'), IP Address (text input), Service Name (text input), Primary DNS Server (text input), Secondary DNS Server (text input), MTU (dropdown menu set to 'Auto'), and Mac Address Clone (text input with a dropdown menu set to '<< MAC Address').

PPTP

Choose PPTP (Point-to-Point-Tunneling Protocol) if your Internet Service Provider (ISP) uses a PPTP connection. Your ISP will provide you with a username and password.

PPTP Server IP Address: Enter the PPTP server IP address provided by your ISP.

Username: Enter the username provided by your ISP.

Password: Enter the password provided by your ISP.

Reconnect Mode: Select either **Always-on**, **On-Demand**, or **Manual**.

Maximum Idle Time: Enter a maximum idle time during which the Internet connection is maintained during inactivity. To disable this feature, enable Auto-reconnect.

Advanced Settings

Address Mode: Select **Static IP** if your ISP assigned you the IP address, subnet mask, gateway, and DNS server addresses. In most cases, select **Dynamic IP**.

Dynamic IP

Primary DNS Server: Enter the primary DNS server IP address assigned by your ISP.

Secondary DNS Server: Enter the secondary DNS server IP address assigned by your ISP.

MTU: Maximum Transmission Unit - you may need to change the MTU for optimal performance with your ISP. The recommended setting is **Auto**.

The screenshot shows the 'Internet' configuration page in the D-Link web interface. The page title is 'Internet' and it includes a navigation bar with 'Home', 'Settings', 'Features', and 'Management'. A breadcrumb trail shows 'Settings >> Internet'. There are 'IPv6' and 'Save' buttons. The main configuration area is titled 'My Internet Connection is:' and is set to 'PPTP'. Below this are fields for 'PPTP Server IP Address', 'Username', and 'Password'. The 'Reconnect Mode' is set to 'On demand' and the 'Maximum Idle Time' is set to '5 minutes'. An 'Advanced Settings...' link is visible at the bottom right. A separate section below shows 'Address Mode' set to 'Dynamic IP', with fields for 'Primary DNS Server', 'Secondary DNS Server', and 'MTU' set to 'Auto'.

Static IP

PPTP IP Address: Enter the IP address provided by your ISP (Static IP only).

PPTP Subnet Mask: Enter the subnet mask provided by your ISP (Static IP only).

PPTP Gateway IP Address: Enter the gateway IP address provided by your ISP (Static IP only).

Primary DNS Server: Enter the primary DNS server IP address assigned by your ISP.

Secondary DNS Server: Enter the secondary DNS server IP address assigned by your ISP.

MTU: Maximum Transmission Unit - you may need to change the MTU for optimal performance with your ISP.

Click **Save** when you are done.

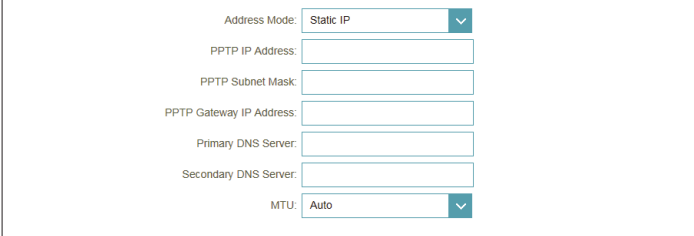

The screenshot shows a configuration form for Static IP. It includes the following fields and controls:

- Address Mode: A dropdown menu with "Static IP" selected.
- PPTP IP Address: An empty text input field.
- PPTP Subnet Mask: An empty text input field.
- PPTP Gateway IP Address: An empty text input field.
- Primary DNS Server: An empty text input field.
- Secondary DNS Server: An empty text input field.
- MTU: A dropdown menu with "Auto" selected.

L2TP

Choose L2TP (Layer 2 Tunneling Protocol) if your Internet Service Provider (ISP) uses a L2TP connection. Your ISP will provide you with a username and password.

L2TP Server IP Address: Enter the L2TP server IP address provided by your ISP.

Username: Enter the username provided by your ISP.

Password: Enter the password provided by your ISP.

Reconnect Mode: Select either **Always-on**, **On-Demand**, or **Manual**.

Maximum Idle Time: Enter a maximum idle time during which the Internet connection is maintained during inactivity. To disable this feature, enable Auto-reconnect.

Advanced Settings

Address Mode: Select **Static IP** if your ISP assigned you the IP address, subnet mask, gateway, and DNS server addresses. In most cases, select **Dynamic IP**.

Dynamic IP

Primary DNS Server: Enter the primary DNS server IP address assigned by your ISP.

Secondary DNS Server: Enter the secondary DNS server IP address assigned by your ISP.

MTU: Maximum Transmission Unit - you may need to change the MTU for optimal performance with your ISP. The recommended setting is **Auto**.

The screenshot shows the D-Link DIR-879 Internet Settings page. The page title is "Internet" and it includes a navigation bar with "Home", "Settings", "Features", and "Management". A globe icon is next to the title. Below the title is a brief instruction: "Use this section to configure your Internet Connection type. There are several connection types to choose from: Static IP, DHCP, PPPoE, PPTP, L2TP and DS-Lite. If you are unsure of your connection method, please contact your Internet service provider. Note: If using the PPPoE option, you will need to remove or disable any PPPoE client software on your computers." The page has a breadcrumb "Settings >> Internet" and a "Save" button. The main configuration area is titled "My Internet Connection is:" and shows "L2TP" selected in a dropdown menu. Below this are input fields for "L2TP Server IP Address:", "Username:", and "Password:". The "Reconnect Mode:" is set to "On demand" in a dropdown menu, and "Maximum Idle Time:" is set to "5 minutes". At the bottom, there is an "Advanced Settings" link. A separate section below shows "Address Mode:" set to "Dynamic IP", "Primary DNS Server:", "Secondary DNS Server:", and "MTU:" set to "Auto".

Static IP

L2TP IP Address: Enter the IP address provided by your ISP (Static IP only).

L2TP Subnet Mask: Enter the subnet mask provided by your ISP (Static IP only).

L2TP Gateway IP Address: Enter the gateway IP address provided by your ISP (Static IP only).

Primary DNS Server: Enter the primary DNS server IP address assigned by your ISP.

Secondary DNS Server: Enter the secondary DNS server IP address assigned by your ISP.

MTU: Maximum Transmission Unit - you may need to change the MTU for optimal performance with your ISP.

Click **Save** when you are done.

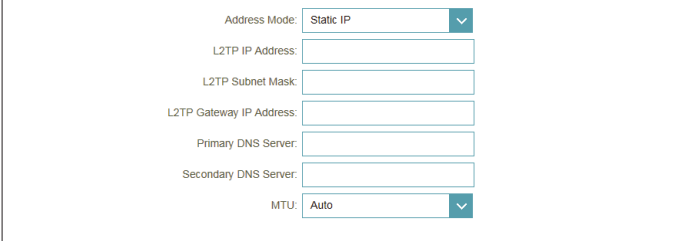

The screenshot shows a configuration form for Static IP. It includes the following fields and controls:

- Address Mode:** A dropdown menu with "Static IP" selected.
- L2TP IP Address:** An empty text input field.
- L2TP Subnet Mask:** An empty text input field.
- L2TP Gateway IP Address:** An empty text input field.
- Primary DNS Server:** An empty text input field.
- Secondary DNS Server:** An empty text input field.
- MTU:** A dropdown menu with "Auto" selected.

DS-Lite

DS-Lite is an IPv6 connection type. After selecting DS-Lite, the following parameters will be available for configuration:

Advanced Settings

DS-Lite Configuration: Select **DS-Lite DHCPv6** to let the router allocate the AFTR IPv6 address automatically. Select **Manual Configuration** to enter the AFTR IPv6 address manually.

DS-Lite DHCPv6

B4 IPv6 Address: Enter the B4 IPv4 address value used here.

WAN IPv6 Address: Once connected, the WAN IPv6 address will be displayed here.

IPv6 WAN Default Gateway: Once connected, the IPv6 WAN default gateway address will be displayed here.

Manual

AFTR IPv6 Address: Enter the AFTR IPv6 address used here.

B4 IPv6 Address: Enter the B4 IPv4 address value used here.

WAN IPv6 Address: Once connected, the WAN IPv6 address will be displayed here.

IPv6 WAN Default Gateway: Once connected, the IPv6 WAN default gateway address will be displayed here.

Click **Save** when you are done.

IPv6

To configure an IPv6 connection, click the **IPv6** link. To return to the IPv4 settings, click **IPv4**.

My Internet Connection Is: Choose your IPv6 connection type from the drop-down menu. You will be presented with the appropriate options for your connection type. Click **Advanced Settings...** to expand the list and see all of the options.

For **Auto Detection** refer to page 50.

For **Static IPv6** refer to page 52.

For **Auto Configuration (SLAAC/DHCPv6)** refer to page 54.

For **PPPoE** refer to page 56.

For **IPv6 in IPv4 Tunnel** refer to page 59.

For **6 to 4** refer to page 61.

For **6rd** refer to page 63.

For **Local Connectivity Only** refer to page 65.

The screenshot shows the D-Link IPv6 configuration interface. At the top, there is a navigation bar with 'Home', 'Settings', 'Features', and 'Management'. Below this, the page title is 'IPv6' with a subtitle: 'All of your IPv6 Internet and network connection details are displayed on this page.' The breadcrumb trail is 'Settings >> Internet >> IPv6'. There are two tabs: 'IPv4' and 'Save'. The 'My Internet Connection is:' dropdown menu is set to 'Auto Detection'. Below this is the 'IPv6 DNS SETTINGS' section with a 'DNS Type:' dropdown set to 'Obtain a DNS server address automatically'. The 'LAN IPv6 ADDRESS SETTINGS' section shows 'LAN IPv6 Address:' and 'LAN IPv6 Link-Local Address: fe80::6e72:20ff:fe15:1654'. There is a link for 'Advanced Settings...'. The 'ADDRESS AUTOCONFIGURATION SETTINGS' section includes 'Enable Automatic IPv6 Address Assignment' (Enabled), 'Enable Automatic DHCP-PD in LAN' (Enabled), 'Autoconfiguration Type:' dropdown set to 'SLAAC+Stateless DHCP', and 'Router Advertisement Lifetime:' set to a default value in minutes. The footer contains 'COPYRIGHT © 2015 D-Link'.

Auto Detection

This is a connection method where the ISP assigns your IPv6 address when your router requests one from the ISP's server. Some ISPs require you to make some settings on your side before your router can connect to the IPv6 Internet.

IPv6 DNS Settings

DNS Type: Select either **Obtain DNS server address automatically** or **Use the following DNS address**.

If **Use the following DNS address** is selected:

Primary DNS Server: If you selected **Use the following DNS address** above, enter the primary DNS server address.

Secondary DNS Server: If you selected **Use the following DNS address** above, enter the secondary DNS server address.

LAN IPv6 Address Settings

LAN IPv6 Address: Displays the router's LAN IPv6 Address link-local address.

LAN IPv6 Link-Local Address: Displays the router's LAN link-local address.

The screenshot shows the D-Link router's IPv6 configuration interface. At the top, there's a navigation bar with 'Home', 'Settings', 'Features', and 'Management'. The main heading is 'IPv6' with a sub-heading: 'All of your IPv6 Internet and network connection details are displayed on this page.' Below this, there's a breadcrumb trail: 'Settings >> Internet >> IPv6'. A 'Save' button is visible. The 'My Internet Connection is:' dropdown is set to 'Auto Detection'. There are two 'IPv6 DNS SETTINGS' sections. The first section has 'DNS Type' set to 'Obtain a DNS server address automatically'. The second section has 'DNS Type' set to 'Use the following DNS address', with empty input fields for 'Primary DNS Server' and 'Secondary DNS Server'. At the bottom, the 'LAN IPv6 ADDRESS SETTINGS' section shows 'LAN IPv6 Address:' and 'LAN IPv6 Link-Local Address: fe80::6e72:20ff:fe15:1654'. An 'Advanced Settings' link is in the bottom right corner.

Advanced Settings - Address Autoconfiguration Settings

Enable Automatic IPv6 Address Assignment: Enable or disable the Automatic IPv6 Address Assignment feature.

Enable Automatic DHCP-PD in LAN: Enable or disable DHCP-PD for other IPv6 routers connected to the LAN interface.
Note: This feature requires a smaller subnet prefix than /64 (i.e. allowing for a larger address allocation), such as /63. Contact your ISP for more information.

Autoconfiguration Type: Select **SLAAC+RDNSS**, **SLAAC+Stateless DHCP**, or **Stateful DHCPv6**.

If you selected **Stateful DHCPv6** as the Autoconfiguration Type:

IPv6 Address Range (Start): Enter the starting IPv6 address for the DHCP server's IPv6 assignment.

IPv6 Address Range (End): Enter the ending IPv6 address for the DHCP server's IPv6 assignment.

IPv6 Advertisement Lifetime: Enter the IPv6 address lifetime (in minutes).

Click **Save** when you are done.

ADDRESS AUTOCONFIGURATION SETTINGS

Enable Automatic IPv6 Address Assignment: Enabled

Enable Automatic DHCP-PD in LAN: Enabled

Autoconfiguration Type: SLAAC+RDNSS

Router Advertisement Lifetime: minutes

ADDRESS AUTOCONFIGURATION SETTINGS

Enable Automatic IPv6 Address Assignment: Enabled

Enable Automatic DHCP-PD in LAN: Enabled

Autoconfiguration Type: SLAAC+Stateless DHCP

Router Advertisement Lifetime: minutes

ADDRESS AUTOCONFIGURATION SETTINGS

Enable Automatic IPv6 Address Assignment: Enabled

Enable Automatic DHCP-PD in LAN: Enabled

Autoconfiguration Type: Stateful DHCPv6

IPv6 Address Range (Start): :00

IPv6 Address Range (End): :00

IPv6 Address Lifetime: minutes

Static IPv6

Select **Static IP** if your IPv6 information is provided by your Internet Service Provider (ISP).

Use Link-Local Address: Enable or disable link-local address use.

Default Gateway: Enter the default gateway for your IPv6 connection.

Primary DNS Server: Enter the primary DNS server address.

Secondary DNS Server: Enter the secondary DNS server address.

If **Use Link-Local Address** is disabled these additional parameters are available for configuration:

IPv6 Address: Enter the address supplied by your ISP.

Subnet Prefix Length: Enter the subnet prefix length supplied by your ISP.

LAN IPv6 Address Settings

LAN IPv6 Address: Enter the LAN (local) IPv6 address for the router.

LAN IPv6 Link-Local Address: Displays the router's LAN link-local address.

The screenshot shows the D-Link IPv6 configuration interface. At the top, there are navigation links for Home, Settings, Features, and Management. The main heading is 'IPv6' with a sub-heading: 'All of your IPv6 Internet and network connection details are displayed on this page.' Below this, there is a breadcrumb trail: 'Settings >> Internet >> IPv6'. A dropdown menu shows 'My Internet Connection is: Static IPv6'. The 'Use Link-Local Address' toggle is set to 'Enabled'. Below it are input fields for 'Default Gateway', 'Primary DNS Server', and 'Secondary DNS Server'. A 'Save' button is visible in the top right corner.

This screenshot shows the same IPv6 configuration page but with the 'Use Link-Local Address' toggle set to 'Disabled'. In addition to the fields for 'Default Gateway', 'Primary DNS Server', and 'Secondary DNS Server', there are now input fields for 'IPv6 Address' and 'Subnet Prefix Length'.

This screenshot shows the 'LAN IPv6 ADDRESS SETTINGS' section. It contains an input field for 'LAN IPv6 Address' followed by '/64'. Below it, the text 'LAN IPv6 Link-Local Address: Not Available' is displayed. A link for 'Advanced Settings' is located in the bottom right corner.

Advanced Settings - Address Autoconfiguration Settings

Enable Automatic IPv6 Address Assignment: Enable or disable the Automatic IPv6 Address Assignment feature.

Autoconfiguration Type: Select **SLAAC+RDNSS**, **SLAAC+Stateless DHCP**, or **Stateful DHCPv6**.

If you selected **Stateful DHCPv6** as the Autoconfiguration Type:

IPv6 Address Range (Start): Enter the starting IPv6 address for the DHCP server's IPv6 assignment.

IPv6 Address Range (End): Enter the ending IPv6 address for the DHCP server's IPv6 assignment.

IPv6 Advertisement Lifetime: Enter the IPv6 address lifetime (in minutes).

Click **Save** when you are done.

ADDRESS AUTOCONFIGURATION SETTINGS

Enable Automatic IPv6 Address Assignment: Enabled

Autoconfiguration Type: SLAAC+RDNSS

Router Advertisement Lifetime: 60 minutes

ADDRESS AUTOCONFIGURATION SETTINGS

Enable Automatic IPv6 Address Assignment: Enabled

Autoconfiguration Type: SLAAC+Stateless DHCP

Router Advertisement Lifetime: 60 minutes

ADDRESS AUTOCONFIGURATION SETTINGS

Enable Automatic IPv6 Address Assignment: Enabled

Autoconfiguration Type: Stateful DHCPv6

IPv6 Address Range (Start): xxxx::00 3

IPv6 Address Range (End): xxxx::00 16

IPv6 Address Lifetime: 60 minutes

Auto Configuration (SLAAC/DHCPv6)

This is a connection method where the ISP assigns your IPv6 address when your router requests one from the ISP's server. Some ISPs require you to make some settings on your side before your router can connect to the IPv6 Internet.

IPv6 DNS Settings

DNS Type: Select either **Obtain DNS server address automatically** or **Use the following DNS address**.

If **Use the following DNS address** is selected:

Primary DNS Server: Enter the primary DNS server address.

Secondary DNS Server: Enter the secondary DNS server address.

LAN IPv6 Address Settings

Enable DHCP-PD: Enable or disable prefix delegation services.

LAN IPv6 Address: If you disabled DHCP-PD, enter the LAN (local) IPv6 address for the router.

LAN IPv6 Link-Local Address: Displays the router's LAN link-local address.

Advanced Settings - Address Autoconfiguration Settings

Enable Automatic IPv6 Address Assignment: Enable or disable the Automatic IPv6 Address Assignment feature.

If DHCP-PD is enabled in LAN IPv6 Address Settings:

Enable Automatic DHCP-PD in LAN: Enable or disable DHCP-PD for other IPv6 routers connected to the LAN interface. **Note:** *This feature requires a smaller subnet prefix than /64 (i.e. allowing for a larger address allocation), such as /63. Contact your ISP for more information.*

Autoconfiguration Type: Select **SLAAC+RDNSS**, **SLAAC+Stateless DHCP**, or **Stateful DHCPv6**.

If you selected **Stateful DHCPv6** as the Autoconfiguration Type:

IPv6 Address Range (Start): Enter the starting IPv6 address for the DHCP server's IPv6 assignment.

IPv6 Address Range (End): Enter the ending IPv6 address for the DHCP server's IPv6 assignment.

IPv6 Advertisement Lifetime: Enter the IPv6 address lifetime (in minutes).

Click **Save** when you are done.

ADDRESS AUTOCONFIGURATION SETTINGS

Enable Automatic IPv6 Address Assignment: Enabled

Enable Automatic DHCP-PD in LAN: Enabled

Autoconfiguration Type: SLAAC+Stateless DHCP

Router Advertisement Lifetime: minutes

ADDRESS AUTOCONFIGURATION SETTINGS

Enable Automatic IPv6 Address Assignment: Enabled

Enable Automatic DHCP-PD in LAN: Enabled

Autoconfiguration Type: SLAAC+RDNSS

Router Advertisement Lifetime: minutes

ADDRESS AUTOCONFIGURATION SETTINGS

Enable Automatic IPv6 Address Assignment: Enabled

Enable Automatic DHCP-PD in LAN: Enabled

Autoconfiguration Type: Stateful DHCPv6

IPv6 Address Range (Start): xxxx::00

IPv6 Address Range (End): xxxx::00

IPv6 Address Lifetime: minutes

PPPoE

Select **PPPoE** if your Internet connection requires you to enter a username and password. This information is provided by your Internet Service Provider (ISP).

PPPoE Session: Choose **Share with IPv4** to re-use your IPv4 PPPoE username and password, or **Create a new session**.

Username: Enter the username provided by your ISP. (Create a new session only)

Password: Enter the password provided by your ISP. (Create a new session only)

Address Mode: Select **Static IP** if your ISP assigned you an IP address. In most cases, select **Dynamic IP**.

IP Address: Enter the IP address provided by your ISP. (Static IP only)

Service Name: Enter the ISP service name (optional).

Reconnect Mode: Select either **Always-on** or **Manual**.

MTU: Maximum Transmission Unit - you may need to change the MTU for optimal performance with your ISP.

The screenshot shows the D-Link router's web interface for IPv6 configuration. The page title is "IPv6" and it includes a sub-header "All of your IPv6 Internet and network connection details are displayed on this page." The breadcrumb trail is "Settings >> Internet >> IPv6". There are two tabs: "IPv4" and "Save".

The configuration fields are as follows:

- My Internet Connection is:** PPPoE (dropdown menu)
- PPPoE Session:** Share with IPv4 (dropdown menu)
- Address Mode:** Dynamic IP (dropdown menu)
- IP Address:** (text input field)
- PPPoE Session:** Create a new session (dropdown menu)
- Username:** (text input field)
- Password:** (text input field)
- Address Mode:** Dynamic IP (dropdown menu)
- Service Name:** (text input field)
- Reconnect Mode:** Always on (dropdown menu)
- MTU:** 1492 bytes
- Address Mode:** Static IP (dropdown menu)
- IP Address:** (text input field)
- Service Name:** (text input field)
- Reconnect Mode:** Always on (dropdown menu)
- MTU:** 1492 bytes

IPv6 DNS Settings

DNS Type: Select either **Obtain DNS server address automatically** or **Use the following DNS address**.

If **Use the following DNS address** is selected:

Primary DNS Server: Enter the primary DNS server address.

Secondary DNS Server: Enter the secondary DNS server address.

LAN IPv6 Address Settings

Enable DHCP-PD: Enable or disable prefix delegation services. This option is only available if you selected **Dynamic IP** for address mode.

LAN IPv6 Address: If DHCP-PD disabled or static address mode is selected, enter the LAN (local) IPv6 address for the router.

LAN IPv6 Link-Local Address: Displays the router's LAN link-local address.

IPv6 DNS SETTINGS

DNS Type: Obtain a DNS server address automatically

IPv6 DNS SETTINGS

DNS Type: Use the following DNS address

Primary DNS Server:

Secondary DNS Server:

LAN IPv6 ADDRESS SETTINGS

Enable DHCP-PD: Enabled

LAN IPv6 Link-Local Address: Not Available

[Advanced Settings...](#)

LAN IPv6 ADDRESS SETTINGS

Enable DHCP-PD: Disabled

LAN IPv6 Address: /64

LAN IPv6 Link-Local Address: Not Available

[Advanced Settings...](#)

Advanced Settings - Address Autoconfiguration Settings

Enable Automatic IPv6 Address Assignment: Enable or disable the Automatic IPv6 Address Assignment feature.

If DHCP-PD is available and enabled in LAN IPv6 Address Settings:

Enable Automatic DHCP-PD in LAN: Enable or disable DHCP-PD for other IPv6 routers connected to the LAN interface. **Note:** This feature requires a smaller subnet prefix than /64 (i.e. allowing for a larger address allocation), such as /63. Contact your ISP for more information.

Autoconfiguration Type: Select **SLAAC+RDNSS**, **SLAAC+Stateless DHCP**, or **Stateful DHCPv6**.

If you selected **Stateful DHCPv6** as the Autoconfiguration Type:

IPv6 Address Range (Start): Enter the starting IPv6 address for the DHCP server's IPv6 assignment.

IPv6 Address Range (End): Enter the ending IPv6 address for the DHCP server's IPv6 assignment.

IPv6 Advertisement Lifetime: Enter the IPv6 address lifetime (in minutes).

Click **Save** when you are done.

ADDRESS AUTOCONFIGURATION SETTINGS

Enable Automatic IPv6 Address Assignment: Enabled

Enable Automatic DHCP-PD in LAN: Enabled

Autoconfiguration Type: SLAAC+Stateless DHCP

Router Advertisement Lifetime: minutes

ADDRESS AUTOCONFIGURATION SETTINGS

Enable Automatic IPv6 Address Assignment: Enabled

Enable Automatic DHCP-PD in LAN: Enabled

Autoconfiguration Type: SLAAC+RDNSS

Router Advertisement Lifetime: minutes

ADDRESS AUTOCONFIGURATION SETTINGS

Enable Automatic IPv6 Address Assignment: Enabled

Enable Automatic DHCP-PD in LAN: Enabled

Autoconfiguration Type: Stateful DHCPv6

IPv6 Address Range (Start): xxxx::00 3

IPv6 Address Range (End): xxxx::00 16

IPv6 Address Lifetime: minutes

IPv6 in IPv4 Tunnel

The user can configure the IPv6 connection to run in IPv4 Tunnel mode. IPv6 over IPv4 tunnelling encapsulates IPv6 packets in IPv4 packets so that IPv6 packets can be sent over an IPv4 infrastructure.

Remote IPv4 Address: Enter the IPv4 remote address you will use.

Remote IPv6 Address: Enter the IPv6 remote address you will use.

Local IPv4 Address: Displays the current local IPv4 address.

Local IPv6 Address: Enter the IPv6 local address you will use.

Subnet Prefix Length: Enter the subnet prefix length supplied by your ISP.

IPv6 DNS Settings

DNS Type: Select either **Obtain DNS server address automatically** or **Use the following DNS address**.

If **Use the following DNS address** is selected:

Primary DNS Server: Enter the primary DNS server address.

Secondary DNS Server: Enter the secondary DNS server address.

The screenshot shows the D-Link IPv6 configuration interface. At the top, there's a navigation bar with 'Home', 'Settings', 'Features', and 'Management'. Below that, the 'IPv6' section is active, with a sub-header 'IPv4' and a 'Save' button. The main configuration area is titled 'IPv6 in IPv4 tunnel' and includes the following fields:

- My Internet Connection is: IPv6 in IPv4 tunnel (dropdown)
- Remote IPv4 Address: [text input]
- Remote IPv6 Address: [text input]
- Local IPv4 Address: 192.168.150.132
- Local IPv6 Address: [text input]
- Subnet Prefix Length: [text input]

This screenshot shows the 'IPv6 DNS SETTINGS' section. The 'DNS Type' dropdown is set to 'Obtain a DNS server address automatically'.

This screenshot shows the 'IPv6 DNS SETTINGS' section with the 'DNS Type' dropdown set to 'Use the following DNS address'. Below this, there are two text input fields for 'Primary DNS Server' and 'Secondary DNS Server'.

LAN IPv6 Address Settings

Enable DHCP-PD: Enable or disable prefix delegation services.

LAN IPv6 Address: If you disabled DHCP-PD, enter the LAN (local) IPv6 address for the router.

LAN IPv6 Link-Local Address: Displays the router's LAN link-local address.

Advanced Settings - Address Autoconfiguration Settings

Enable Automatic IPv6 Address Assignment: Enable or disable the Automatic IPv6 Address Assignment feature.

Autoconfiguration Type: Select **SLAAC+RDNSS**, **SLAAC+Stateless DHCP**, or **Stateful DHCPv6**.

If you selected **Stateful DHCPv6** as the Autoconfiguration Type:

IPv6 Address Range (Start): Enter the starting IPv6 address for the DHCP server's IPv6 assignment.

IPv6 Address Range (End): Enter the ending IPv6 address for the DHCP server's IPv6 assignment.

IPv6 Advertisement Lifetime: Enter the IPv6 address lifetime (in minutes).

Click **Save** when you are done.

LAN IPv6 ADDRESS SETTINGS

Enable DHCP-PD: Enabled

LAN IPv6 Link-Local Address: Not Available

[Advanced Settings](#)

LAN IPv6 ADDRESS SETTINGS

Enable DHCP-PD: Disabled

LAN IPv6 Address:

LAN IPv6 Link-Local Address: Not Available

[Advanced Settings](#)

ADDRESS AUTOCONFIGURATION SETTINGS

Enable Automatic IPv6 Address Assignment: Enabled

Enable Automatic DHCP-PD in LAN: Enabled

Autoconfiguration Type: ▼

Router Advertisement Lifetime: minutes

ADDRESS AUTOCONFIGURATION SETTINGS

Enable Automatic IPv6 Address Assignment: Enabled

Enable Automatic DHCP-PD in LAN: Enabled

Autoconfiguration Type: ▼

Router Advertisement Lifetime: minutes

ADDRESS AUTOCONFIGURATION SETTINGS

Enable Automatic IPv6 Address Assignment: Enabled

Enable Automatic DHCP-PD in LAN: Enabled

Autoconfiguration Type: ▼

IPv6 Address Range (Start): xxxx :00

IPv6 Address Range (End): xxxx :00

IPv6 Address Lifetime: minutes

6to4

In this section the user can configure the IPv6 6 to 4 connection settings. 6to4 is an IPv6 address assignment and automatic tunneling technology that is used to provide unicast IPv6 connectivity between IPv6 sites and hosts across the IPv4 Internet.

6to4 Address: Displays the 6 to 4 address.

6to4 Relay: Enter the 6 to 4 relay supplied by your ISP.

Primary DNS Server: Enter the primary DNS server address.

Secondary DNS Server: Enter the secondary DNS server address.

LAN IPv6 Address Settings

LAN IPv6 Address: Enter the LAN (local) IPv6 address for the router.

LAN IPv6 Link-Local Address: Displays the router's LAN link-local address.

The screenshot shows the D-Link router's web interface for IPv6 configuration. The page title is "IPv6" and it includes a navigation menu with "Home", "Settings", "Features", and "Management". The breadcrumb trail is "Settings >> Internet >> IPv6". The "My Internet Connection is" dropdown is set to "6to4". The "6to4 Address" is 192.168.150.132, and the "6to4 Relay" is 192.88.99.1. There are input fields for "Primary DNS Server" and "Secondary DNS Server". The "LAN IPv6 ADDRESS SETTINGS" section shows the "LAN IPv6 Address" as FFFF:FFFF:FFFF: [] ::1/64 and the "LAN IPv6 Link-Local Address" as "Not Available". A "Save" button is visible in the top right corner.

Advanced Settings - Address Autoconfiguration Settings

Enable Automatic IPv6 Address Assignment: Enable or disable the Automatic IPv6 Address Assignment feature.

Autoconfiguration Type: Select **SLAAC+RDNSS**, **SLAAC+Stateless DHCP**, or **Stateful DHCPv6**.

If you selected **Stateful DHCPv6** as the Autoconfiguration Type:

IPv6 Address Range (Start): Enter the starting IPv6 address for the DHCP server's IPv6 assignment.

IPv6 Address Range (End): Enter the ending IPv6 address for the DHCP server's IPv6 assignment.

IPv6 Advertisement Lifetime: Enter the IPv6 address lifetime (in minutes).

Click **Save** when you are done.

ADDRESS AUTOCONFIGURATION SETTINGS

Enable Automatic IPv6 Address Assignment: Enabled

Enable Automatic DHCP-PD in LAN: Enabled

Autoconfiguration Type: SLAAC+Stateless DHCP

Router Advertisement Lifetime: minutes

ADDRESS AUTOCONFIGURATION SETTINGS

Enable Automatic IPv6 Address Assignment: Enabled

Enable Automatic DHCP-PD in LAN: Enabled

Autoconfiguration Type: SLAAC+RDNSS

Router Advertisement Lifetime: minutes

ADDRESS AUTOCONFIGURATION SETTINGS

Enable Automatic IPv6 Address Assignment: Enabled

Enable Automatic DHCP-PD in LAN: Enabled

Autoconfiguration Type: Stateful DHCPv6

IPv6 Address Range (Start): xxxx::00 3

IPv6 Address Range (End): xxxx::00 16

IPv6 Address Lifetime: minutes

6rd

In this section the user can configure the IPv6 6rd connection settings.

Assign IPv6 Prefix: Currently unsupported.

Primary DNS Server: Enter the primary DNS server address.

Secondary DNS Server: Enter the secondary DNS server address.

6rd Manual Configuration

Enable Hub and Spoke Mode: Enable if you want to minimize the number of routes to the destination by using a hub and spoke method of networking.

6rd Configuration: Choose the **6rd DHCPv4 Option** to automatically discover and populate the data values, or **Manual Configuration** to enter the settings yourself.

If you selected **Manual configuration**

6rd IPv6 Prefix: Enter the 6rd IPv6 prefix and mask length supplied by your ISP.

WAN IPv4 Address Displays the router's IPv4 address.

6rd Border Relay IPv4 Address: Enter the 6rd border relay IPv4 address settings supplied by your ISP.

LAN IPv6 Address Settings

LAN IPv6 Address: Displays the router's LAN IPv6 Address link-local address.

LAN IPv6 Link-Local Address: Displays the router's LAN link-local address.

The screenshot shows the D-Link DIR-879 IPv6 configuration interface. The top navigation bar includes 'Home', 'Settings', 'Features', and 'Management'. The main heading is 'IPv6' with a sub-heading: 'All of your IPv6 Internet and network connection details are displayed on this page.' Below this, there's a breadcrumb trail 'Settings >> Internet >> IPv6' and a 'Save' button. The 'My Internet Connection is:' dropdown is set to '6rd'. The 'Assign IPv6 Prefix' field is disabled. The 'Primary DNS Server' and 'Secondary DNS Server' fields are empty. The '6RD MANUAL CONFIGURATION' section has 'Enable Hub and Spoke Mode' set to 'Enabled' and '6rd Configuration' set to '6rd DHCPv4 Option'.

This screenshot is similar to the previous one but shows the '6rd Configuration' dropdown set to 'Manual Configuration'. The 'Enable Hub and Spoke Mode' remains 'Enabled'.

This screenshot shows the '6rd Manual Configuration' section with 'Manual Configuration' selected. The '6rd IPv6 Prefix' field is filled with '192.168.150.155' and a mask length of '32'. The 'WAN IPv4 Address' field is filled with '192.168.150.155'. The '6rd Border Relay IPv4 Address' field is empty.

The screenshot shows the 'LAN IPv6 ADDRESS SETTINGS' section. It displays 'LAN IPv6 Address: Not Available' and 'LAN IPv6 Link-Local Address: Not Available'. There is a link for 'Advanced Settings' at the bottom right.

Advanced Settings - Address Autoconfiguration Settings

Enable Automatic IPv6 Address Assignment: Enable or disable the Automatic IPv6 Address Assignment feature.

Autoconfiguration Type: Select **SLAAC+RDNSS**, **SLAAC+Stateless DHCP**, or **Stateful DHCPv6**.

If you selected **Stateful DHCPv6** as the Autoconfiguration Type:

IPv6 Address Range (Start): Enter the starting IPv6 address for the DHCP server's IPv6 assignment.

IPv6 Address Range (End): Enter the ending IPv6 address for the DHCP server's IPv6 assignment.

IPv6 Advertisement Lifetime: Enter the IPv6 address lifetime (in minutes).

Click **Save** when you are done.

ADDRESS AUTOCONFIGURATION SETTINGS

Enable Automatic IPv6 Address Assignment: Enabled

Autoconfiguration Type: SLAAC+RDNSS

Router Advertisement Lifetime: 60 minutes

ADDRESS AUTOCONFIGURATION SETTINGS

Enable Automatic IPv6 Address Assignment: Enabled

Autoconfiguration Type: SLAAC+Stateless DHCP

Router Advertisement Lifetime: 60 minutes

ADDRESS AUTOCONFIGURATION SETTINGS

Enable Automatic IPv6 Address Assignment: Enabled

Autoconfiguration Type: Stateful DHCPv6

IPv6 Address Range (Start): xxxx::00 3

IPv6 Address Range (End): xxxx::00 16

IPv6 Address Lifetime: 60 minutes

Local Connectivity Only

Local Connectivity Only allows you to set up an IPv6 connection that will not connect to the Internet.

Advanced Settings

IPv6 ULA Settings

Enable ULA: Click here to enable Unique Local IPv6 Unicast Addresses settings.

If you selected **Enable ULA** and **Disabled Default ULA Prefix:**

ULA Prefix: Enter your own ULA prefix.

Current IPv6 ULA Settings

Current ULA Prefix: Displays the current ULA prefix.

LAN IPv6 ULA: Displays the LAN's IPv6 ULA.

Click **Save** when you are done.

The screenshot shows the D-Link DIR-879 IPv6 settings page. The page title is "IPv6" and it states "All of your IPv6 Internet and network connection details are displayed on this page." The breadcrumb trail is "Settings >> Internet >> IPv6". There are "IPv4" and "Save" buttons. The "My Internet Connection is:" dropdown is set to "Local Connectivity Only". Below this are three sections for IPv6 ULA settings:

- IPv6 ULA SETTINGS:** "Enable ULA:" is set to "Enabled" and "Use Default ULA Prefix:" is set to "Enabled".
- IPv6 ULA SETTINGS:** "Enable ULA:" is set to "Enabled" and "Use Default ULA Prefix:" is set to "Disabled". The "ULA Prefix:" field is empty, followed by "/64".
- CURRENT IPv6 ULA SETTINGS:** "Current ULA Prefix:" is "Not Available" and "LAN IPv6 ULA:" is "Not Available".

Wireless

In the Settings menu on the bar on the top of the page, click **Wireless** to see the wireless configuration options. To configure the router's guest zone, click the **Guest Zone** link. Refer to page 69 for details. To simplify wireless configuration, Smart Connect is enabled by default. Disable Smart Connect to individually configure 2.4 GHz and 5 GHz modes.

Smart Connect

Smart Connect: Enable or disable the Smart Connect Feature. When enabled only a few configuration options are available.

Wi-Fi Name (SSID): Create a name for your wireless network using up to 32 characters.

Password: Create a password to use for wireless security. Wireless clients will need to enter this password to successfully connect to the network.

Advanced Settings

Security Mode: Choose **None**, **WEP**, or **WPA/WPA2-(Personal)** (recommended).

Transmission Power: Select the desired wireless transmission power.

Schedule: Use the drop-down menu to select the time schedule that the rule will be enabled on. The schedule may be set to **Always Enable**, or you can create your own schedules in the **Schedules** section. Refer to page 84 for more information.

Click **Save** when you are done.

The screenshot shows the D-Link router's configuration interface for the 'Wireless' section. At the top, there is a navigation bar with 'Home', 'Settings', 'Features', and 'Management'. The 'Wireless' title is prominently displayed, followed by a sub-header and a brief instruction: 'Use this section to configure the wireless settings for your D-Link Router. Please make sure that any changes made in this section will need to be updated on your wireless device.' Below this, there are two tabs: 'Guest Zone' and 'Save'. The 'Smart Connect' section is active, showing a toggle switch for 'Smart Connect' set to 'Enabled'. Underneath, there are two input fields: 'Wi-Fi Name (SSID)' containing 'dlink-1654' and 'Password' containing 'abcde12345'. A link for 'Advanced Settings' is located at the bottom right of this section. The bottom part of the screenshot shows three dropdown menus: 'Security Mode' set to 'WPA/WPA2-Personal', 'Transmission Power' set to 'High', and 'Schedule' set to 'Always Enable'.

Wireless

If Smart Connect is disabled, the following traditional configuration options will become available for both the 2.4 and 5 GHz wireless networks:

2.4GHz / 5GHz

Status: Enable or disable the 2.4 GHz / 5 GHz wireless network.

Wi-Fi Name (SSID): Create a name for your wireless network using up to 32 characters.

Password: Create a password to use for wireless security.

Advanced Settings

Security Mode: Choose **None**, **WEP**, or **WPA/WPA2-(Personal)** (recommended).

802.11 Mode (2.4 GHz): Select the desired wireless networking standards to use. The available options for the 2.4 GHz wireless network are **Mixed 802.11b/g/n**, **Mixed 802.11g/n**, **802.11n only**.

802.11 Mode (5 GHz): Select the desired wireless networking standards to use. The available options for the 5 GHz wireless network are **Mixed 802.11a/n/ac**, **Mixed 802.11n/ac**, **802.11ac only**, **Mixed 802.11a/n**, **Mixed 802.11n only**, or **802.11a only**.

Wi-Fi Channel: Select the desired channel. The default is **Auto** (recommended).

Transmission Power: Select the desired wireless transmission power.

Channel Width (2.4 GHz): Select **Auto 20/40** if you are using both 802.11n and non-802.11n devices, or select **20 MHz** if you are not using any 802.11n devices.

Channel Width (5 GHz): Select **Auto 20/40/80** if you are using 802.11ac, 802.11n, and 802.11a devices, select **Auto 20/40** if you are using 802.11n and 802.11a devices, or select **20 MHz** if you are only using 802.11a devices.

HT20/40 Coexistence: Enable or disable HT20/40 Coexistence.

Visibility Status: The default setting is **Visible**. Select **Invisible** if you do not want to broadcast the SSID of your wireless network.

Schedule: Use the drop-down menu to select the time schedule that the rule will be enabled on. The schedule may be set to **Always Enable**, or you can create your own schedules in the **Schedules** section. Refer to page 84 for more information.

Click **Save** when you are done.

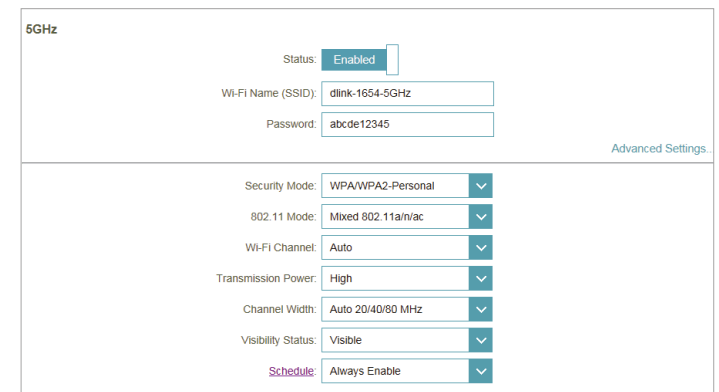
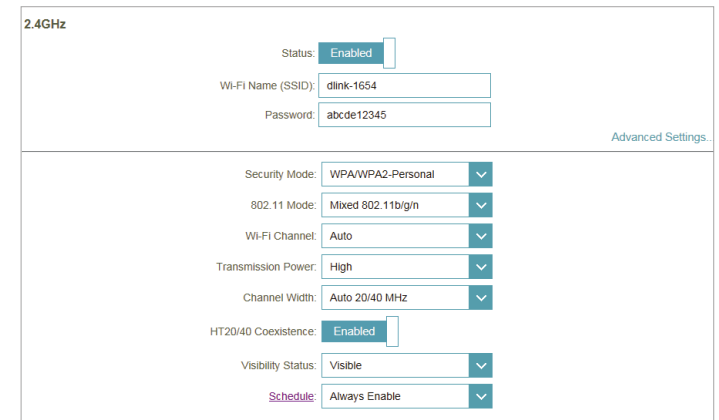
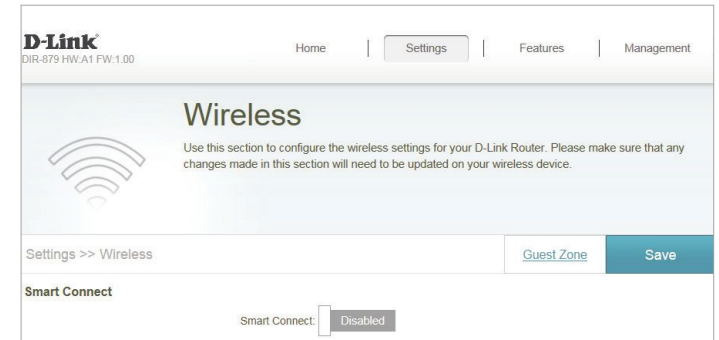

Guest Zone

The guest zone feature will allow you to create temporary zones that can be used by guests to access the Internet. These zones will be separate from your main wireless network. In the Settings menu on the bar on the top of the page, click **Wireless**, then click the **Guest Zone** link. Click **Advanced Settings...** to expand the list and see all of the options.

If Smart Connect is **Enabled** the following options will appear:

Status: Enable or disable the guest zone for each wireless frequency band.

Wi-Fi Name (SSID): Enter a wireless network name (SSID) that is different from your main wireless network.

Password: Create a password to use for wireless security. Wireless clients will need to enter this password to successfully connect to the guest zone.

If Smart Connect is **Disabled** you may individually configure the 2.4 and 5 GHz wireless network settings.

2.4GHz / 5GHz

Status: Enable or disable the 2.4 GHz / 5 GHz wireless network.

Wi-Fi Name (SSID): Create a name for your wireless network using up to 32 characters.

Password: Create a password to use for wireless security.

Home Network Access

Internet Access Only: Enabling this option will confine connectivity to the Internet, disallowing guests from accessing other local network devices.

Click **Save** when you are done.

Status: Enabled

Wi-Fi Name (SSID):

Password:

2.4GHz

Status: Enabled

Wi-Fi Name (SSID):

Password:

5GHz

Status: Enabled

Wi-Fi Name (SSID):

Password:

Home Network Access

Internet Access Only: Enabled

Network

This section will allow you to change the local network settings of the router and to configure the DHCP settings. In the Settings menu on the bar on the top of the page, click **Network**. Click **Advanced Settings...** to expand the list and see all of the options.

Network Settings

LAN IP Address: Enter the IP address of the router. The default IP address is **192.168.0.1**. If you change the IP address, once you click **Save**, you will need to enter the new IP address in your browser to get back into the configuration utility

Subnet Mask: Enter the subnet mask of the router. The default subnet mask is **255.255.255.0**.

Management Link: The default address to access the router's configuration is **http://dlinkrouter.local/**. Here, you can replace **dlinkrouter** with a name of your choice.

Local Domain Name: Enter the domain name (optional).

Enable DNS Relay: Disable to transfer the DNS server information from your ISP to your computers. If enabled, your computers will use the router for a DNS server.

The screenshot shows the D-Link web interface for the Network Settings page. At the top, there is a navigation bar with 'Home', 'Settings', 'Features', and 'Management'. Below the navigation bar, the page title is 'Network'. A sub-header reads: 'Use this section to configure the network settings for your device. You can enter a name for your device in the management link field, and use the link to access web UI in a web browser. Recommend to change the management link if there are more than one D-Link devices within the network.' Below this, there is a 'Settings >> Network' breadcrumb and a 'Save' button. The main content area is titled 'Network Settings' and contains the following fields: 'LAN IP Address' with the value '192.168.0.1', 'Subnet Mask' with the value '255.255.255.0', 'Management Link' with the value 'http://dlinkrouter.local/', 'Local Domain Name' (empty), and 'Enable DNS Relay' with a dropdown menu set to 'Enabled'. An 'Advanced Settings...' link is located at the bottom right of the form.

Advanced Settings - DHCP Server

Status: Enable or disable the DHCP server.

DHCP IP Address Range: Enter the starting and ending IP addresses for the DHCP server's IP assignment.

Note: *If you statically (manually) assign IP addresses to your computers or devices, make sure the IP addresses are outside of this range or you may have an IP conflict.*

DHCP Lease Time: Enter the length of time for the IP address lease in minutes.

Always Broadcast: Enable this feature to broadcast your networks DHCP server to LAN/WLAN clients.

Advanced Settings

WAN Port Speed: You may set the port speed of the Internet port to 10 Mbps, 100 Mbps, 1000 Mbps, or Auto (recommended).

UPnP: Enable or disable Universal Plug and Play (UPnP). UPnP provides compatibility with networking equipment, software and peripherals.

IPv4 Multicast Stream: Enable to allow IPv4 multicast traffic to pass through the router from the Internet.

IPv6 Multicast Stream: Enable to allow IPv6 multicast traffic to pass through the router from the Internet.

Click **Save** when you are done.

DHCP Server

Status: Enabled

DHCP IP Address Range: 192.168.0.100 to 192.168.0.199

DHCP Lease Time: 10080 minutes

Always Broadcast: Disabled
(compatibility for some DHCP Clients)

Advanced Settings

WAN Port Speed:

UPnP: Enabled

IPv4 Multicast Streams: Disabled

IPv6 Multicast Streams: Enabled

Features

QoS Engine

This section will allow you to prioritize particular clients over others, so that those clients receive higher bandwidth. For example, if one client is streaming a movie and another is downloading a non-urgent file, you might wish to assign the former device a higher priority than the latter so that the movie streaming is not disrupted by the traffic of the other devices on the network.

In the Features menu on the bar on the top of the page, click **QoS Engine**.

Under All Devices, you will see device cards representing each connected client. If some are off-screen, you can use the < and > buttons to scroll through the cards.

A maximum of **one** device can be assigned **Highest** priority.

A maximum of **two** devices can be assigned **High** priority.

A maximum of **eight** devices can be assigned **Medium** priority.

If no devices are explicitly assigned a priority, they will all be treated with equal priority. If some devices are not assigned a priority and others are, the unassigned devices will be treated with the lowest priority.

To assign a priority level to a device, drag the device card from the All Devices list over an empty slot and release the mouse button. The card will remain in the slot. If you want to remove a priority assignment from a device and return it to the All Devices list, click the cross icon in the top right of the device card.

Click **Save** when you are done.

The screenshot displays the D-Link QoS Engine configuration interface. At the top, there are navigation links for Home, Settings, Features, and Management. The main heading is 'QoS Engine' with a sub-note: 'Connected clients can be assigned Internet access priority. Click and drag client cards into open slots.' Below this, there is a 'Save' button. The 'Bandwidth' section contains two input fields: 'Uplink Speed (Mbps)' with a value of 2 and 'Downlink Speed (Mbps)' with a value of 8. The 'Connected Clients' section shows a list of devices, with one device card (08203PCWIN7) being dragged over a 'Highest' priority slot. The priority slots are labeled 'Highest', 'High', and 'Medium'.

This is a close-up view of the bandwidth configuration section. It features the title 'Bandwidth' and two input fields: 'Uplink Speed (Mbps)' with a value of 2 and 'Downlink Speed (Mbps)' with a value of 8.

Firewall Settings

The router's firewall protects your network from malicious attacks over the Internet. In the Features menu on the bar on the top of the page, click **Firewall Settings**. Click **Advanced Settings...** to expand the list and see all of the options.

Enable DMZ: Enable or disable Demilitarized Zone (DMZ). This completely exposes the client to threats over the Internet, and is not recommended in ordinary situations.

DMZ IP Address: If you enabled DMZ, enter the IP address of the client you wish to expose, or use the drop-down menu to quickly select it.

Enable SPI IPv4: Enabling Stateful Packet Inspection (SPI) helps to prevent cyber attacks by validating that the traffic passing through the session conforms to the protocol.

Enable Anti-Spoof Checking: Enable this feature to protect your network from certain kinds of "spoofing" attacks.

IPv6 Simple Security: Enable or disable IPv6 simple security.

IPv6 Ingress Filtering: Enable or disable IPv6 ingress filtering.

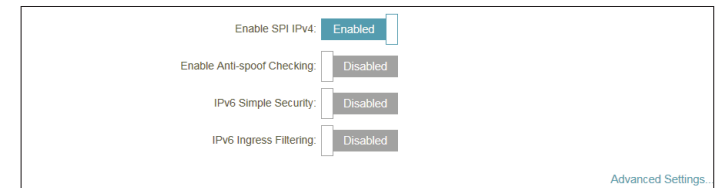
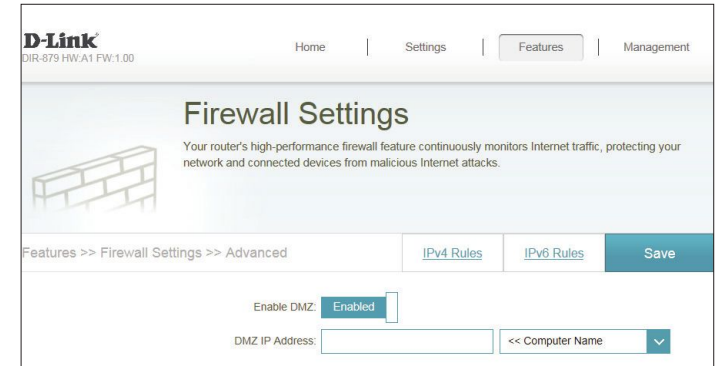

Advanced Settings - Application Level Gateway (ALG) Configuration

PPTP: Allows multiple machines on the LAN to connect to their corporate network using the PPTP protocol.

IPSec (VPN): Allows multiple VPN clients to connect to their corporate network using IPSec. Some VPN clients support traversal of IPSec through NAT. This Application Level Gateway (ALG) may interfere with the operation of such VPN clients. If you are having trouble connecting with your corporate network, try turning this ALG off. Please check with the system administrator of your corporate network whether your VPN client supports NAT traversal.

RTSP: Allows applications that uses Real Time Streaming Protocol (RTSP) to receive streaming media from the Internet.

SIP: Allows devices and applications using VoIP (Voice over IP) to communicate across NAT. Some VoIP applications and devices have the ability to discover NAT devices and work around them. This ALG may interfere with the operation of such devices. If you are having trouble making VoIP calls, try turning this ALG off.

Click **Save** when you are done.

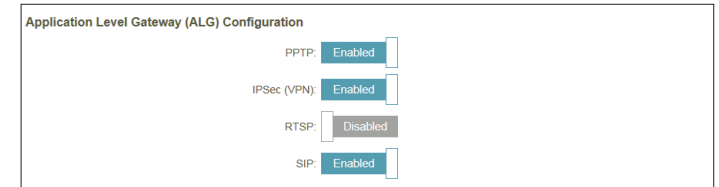

IPv4/IPv6 Rules

The IPv4/IPv6 Rules section is an advanced option that lets you configure what kind of traffic is allowed to pass through the network. To configure the IPv4 rules, from the Firewall Settings page click **IPv4 Rules**. To configure IPv6 rules, from the Firewall Settings page click **IPv6 Rules**. To return to the main Firewall Settings page, click **Security Check**.

To begin, use the drop-down menu to select whether you want to **ALLOW** or **DENY** the rules you create. You can also choose to turn filtering **OFF**.

If you wish to remove a rule, click on its trash can icon in the Delete column. If you wish to edit a rule, click on its pencil icon in the Edit column. If you wish to create a new rule, click the **Add Rules** button. Click **Save** when you are done. If you edit or create a rule, the following options will appear:

Name: Enter a name for the rule.

Source IP Address Range: Enter the source IP address range that the rule will apply to, and using the drop-down menu, specify whether it is a **WAN** or **LAN** IP address.

Destination IP Address Range: Enter the destination IP address range that the rule will apply to, and using the drop-down menu, specify whether it is a **WAN** or **LAN** IP address.

Port Range: Select the protocol of the traffic to allow or deny (**Any**, **TCP**, or **UDP**) and then enter the range of ports that the rule will apply to.

Schedule: Use the drop-down menu to select the time schedule that the rule will be enabled on. The schedule may be set to **Always Enable**, or you can create your own schedules in the **Schedules** section. Refer to page 84 for more information.

Click **Apply** when you are done.

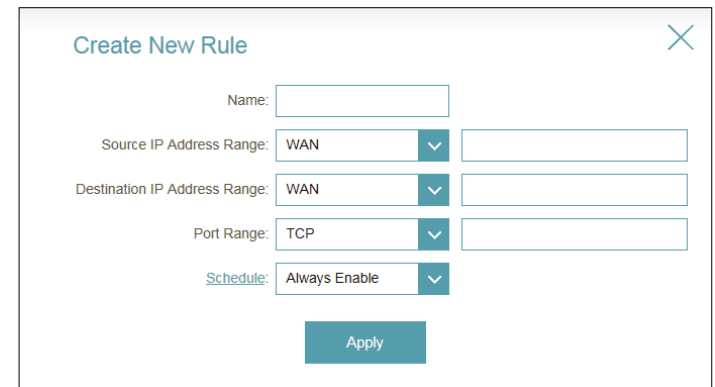
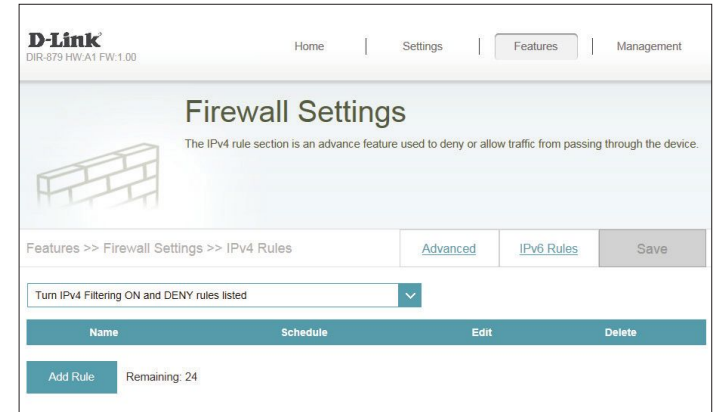

Port Forwarding

Port forwarding allows you to specify a port or range of ports to open for specific devices on the network. This might be necessary for certain applications to connect through the router. In the Features menu on the bar on the top of the page, click **Port Forwarding**.

If you wish to remove a rule, click on its trash can icon in the Delete column. If you wish to edit a rule, click on its pencil icon in the Edit column. If you wish to create a new rule, click the **Add Rules** button. Click **Save** when you are done. If you edit or create a rule, the following options will appear:

Name: Enter a name for the rule.

Local IP: Enter the IP address of the computer on your local network that you want to allow the incoming service to. Alternatively, select the device from the drop-down menu.

TCP Port: Enter the TCP ports that you want to open. You can enter a single port or a range of ports. Separate ports with a comma (for example: 24,1009,3000-4000).

UDP Port: Enter the UDP ports that you want to open. You can enter a single port or a range of ports. Separate ports with a comma (for example: 24,1009,3000-4000).

Schedule: Use the drop-down menu to select the time schedule that the rule will be enabled on. The schedule may be set to **Always Enable**, or you can create your own schedules in the **Schedules** section. Refer to page 84 for more information.

Click **Apply** when you are done.

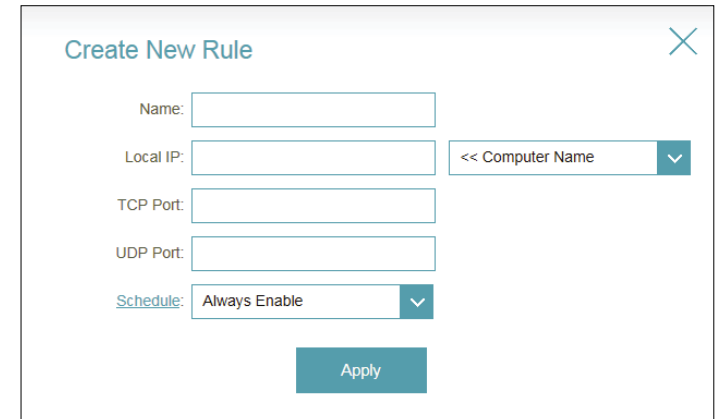
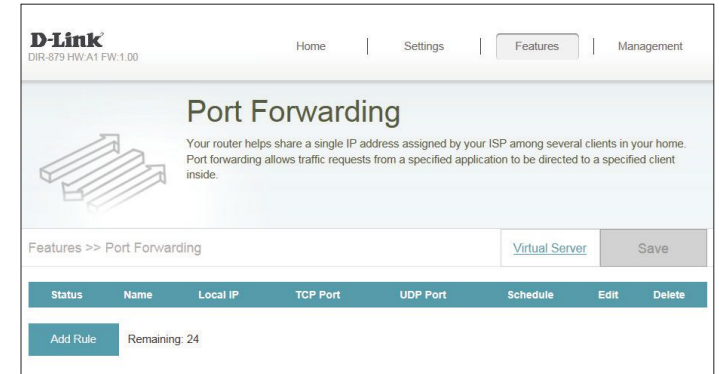

Virtual Server

The virtual server allows you to specify a single public port on your router for redirection to an internal LAN IP Address and Private LAN port. To configure the virtual server, from the Port Forwarding page click **Virtual Server**. To return to the main Port Forwarding page, click **Port Forwarding**.

If you wish to remove a rule, click on its trashcan icon in the Delete column. If you wish to edit a rule, click on its pencil icon in the Edit column. If you wish to create a new rule, click the **Add Rules** button. Click **Save** when you are done. If you edit or create a rule, the following options will appear:

Name: Enter a name for the rule. Alternatively, select the protocol/Application from the drop-down menu.

Local IP: Enter the IP address of the computer on your local network that you want to allow the incoming service to. Alternatively, select the device from the drop-down menu.

Protocol: Select the protocol of the traffic to allow or deny (**TCP**, **UDP**, **Both**, or **Other**).

Protocol Number: If you entered **Other** above, enter the protocol number.

External Port: Enter the public port you want to open.

Internal Port: Enter the private port you want to open.

Schedule: Use the drop-down menu to select the time schedule that the rule will be enabled on. The schedule may be set to **Always Enable**, or you can create your own schedules in the **Schedules** section. Refer to page 84 for more information.

Click **Apply** when you are done.

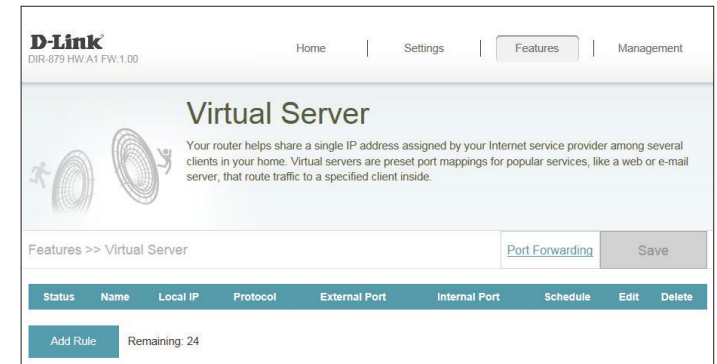

Website Filter

The website filter settings allow you to block access to certain web sites. You can either create a list of sites to block, or create a list of sites to allow (with all other sites being blocked).

In the Features menu on the bar on the top of the page, click **Website Filter**.

If you want to create a list of sites to block, select **DENY computers access to ONLY these sites** from the drop-down menu. All other sites will be accessible. If you want to specify a list of sites to allow, select **ALLOW computers access to ONLY these sites** from the drop-down menu. All other sites will be blocked.

You may specify a maximum of fifteen web sites. To add a new site to the list, click **Create New Rule**. Next, under Website URL/Domain enter the URL or domain. If you wish to remove a rule, click on its trashcan icon in the Delete column. If you wish to edit a rule, simply replace the URL or domain.

Click **Save** when you are done.

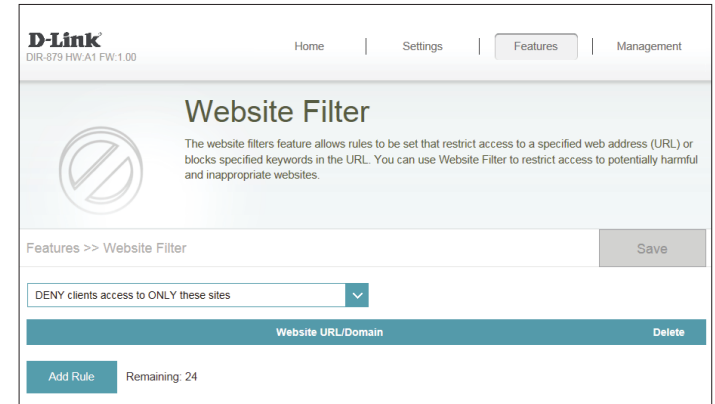

Static Routes

The Static Routes section allows you to define custom routes to control how data traffic is moved around your network.

In the Features menu on the bar on the top of the page, click **Static Routes**. To configure IPv6 rules, click **IPv6** and refer to page 80. To return to the main IPv4 static routes page, click **IPv4**.

If you wish to remove a rule, click on its trash can icon in the Delete column. If you wish to edit a rule, click on its pencil icon in the Edit column. If you wish to create a new rule, click the **Add Rules** button. Click **Save** when you are done. If you edit or create a rule, the following options will appear:

Name: Enter a name for the rule.

Destination Network: Enter the IP address of packets that will take this route.

Mask: Enter the netmask of the route.

Gateway: Enter your next hop gateway to be taken if this route is used.

Metric: The route metric is a value from 1 to 16 that indicates the cost of using this route. A value 1 is the lowest cost and 15 is the highest cost.

Interface: Select the interface that the IP packet must use to transit out of the router when this route is used.

Click **Apply** when you are done.

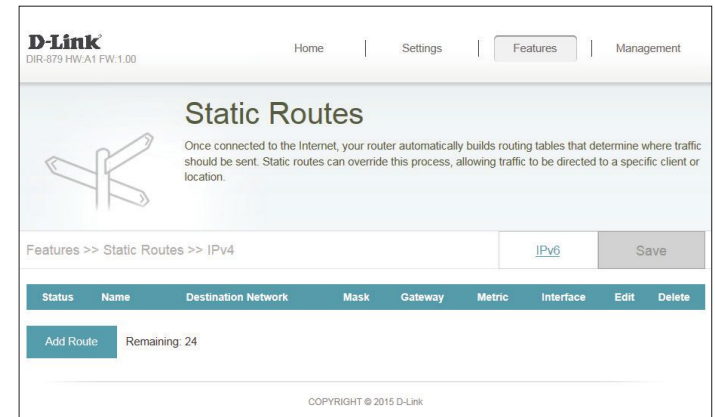

IPv6

To configure IPv6 rules, on the Static Routes page click **IPv6**. To return to the main IPv4 static routes page, click **IPv4**.

If you wish to remove a rule, click on its trash can icon in the Delete column. If you wish to edit a rule, click on its pencil icon in the Edit column. If you wish to create a new rule, click the **Add Rules** button. Click **Save** when you are done. If you edit or create a rule, the following options will appear:

Name: Enter a name for the rule.

DestNetwork: This is the IP address of the router used to reach the specified destination.

PrefixLen: Enter the IPv6 address prefix length of the packets that will take this route.

Gateway: Enter your next hop gateway to be taken if this route is used.

Metric: Enter the metric value for this rule here.

Interface: Select the interface that the IP packet must use to transit out of the router when this route is used.

Click **Apply** when you are done.

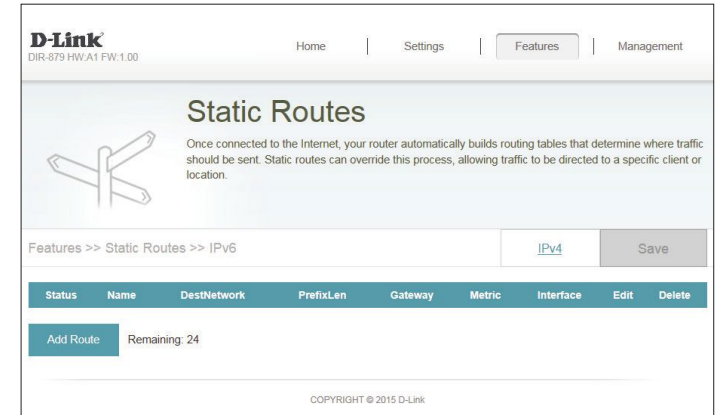

Create New Route ✕

Name:

DestNetwork:

PrefixLen:

Gateway:

Metric:

Interface: WAN ▼

Dynamic DNS

Most Internet Service Providers (ISPs) assign dynamic (changing) IP addresses. Using a dynamic DNS service provider, people can enter your domain name in their web browser to connect to your server no matter what your IP address is.

In the Features menu on the bar on the top of the page, click **Dynamic DNS**.

Enable Dynamic DNS: Enabling dynamic DNS will reveal further configuration options.

Status: Displays the current dynamic DNS connection status.

Server Address: Enter the address of your dynamic DNS server, or select one from the drop-down menu.

Host Name: Enter the host name that you registered with your dynamic DNS service provider.

User Name: Enter your dynamic DNS username.

Password: Enter your dynamic DNS password.

Time Out: Enter a timeout time (in hours).

Click **Save** when you are done.

At the bottom of the page are the IPv6 host settings. To configure an IPv6 dynamic DNS host, refer to page 82.

D-Link
DIR-879 HW:A1 FW:1.00

Home | Settings | **Features** | Management

Dynamic DNS

Dynamic Domain Name Service allows your router to associate an easy-to-remember domain name such as [YourDomainName].com with the regularly changing IP address assigned by your Internet Service provider. This feature is helpful when running a virtual server.

Features >> Dynamic DNS Save

Enable Dynamic DNS: Enabled

Status: Disconnected

Server Address: dyndns.com

Host Name:

User Name:

Password:

Time Out: hours

Status	Host Name	IPv6 Address	Edit	Delete
Add Record	Remaining: 10			

COPYRIGHT © 2015 D-Link

IPv6 Host

The IPv6 host settings are found at the bottom of the Dynamic DNS page.

If you wish to remove a rule, click on its trash can icon in the Delete column. If you wish to edit a rule, click on its pencil icon in the Edit column. If you wish to create a new rule, click the **Add Rules** button. Click **Save** when you are done. If you edit or create a rule, the following options will appear:

Host Name: Enter the host name that you registered with your dynamic DNS service provider.

IPv6 Address: Enter the IPv6 address of the dynamic DNS server. Alternatively, select the server device in the drop-down menu.

Click **Apply** when you are done.

D-Link
DIR-879 HV.A1 FW:1.00

Home | Settings | Features | Management

Dynamic DNS

Dynamic Domain Name Service allows your router to associate an easy-to-remember domain name such as [YourDomainName].com with the regularly changing IP address assigned by your Internet Service provider. This feature is helpful when running a virtual server.

Features >> Dynamic DNS Save

Enable Dynamic DNS: Enabled

Status: Disconnected

Server Address: ▼

Host Name:

User Name:

Password:

Time Out: hours

Status	Host Name	IPv6 Address	Edit	Delete
Add Record Remaining: 10				

COPYRIGHT © 2015 D-Link

Create New Record

Host Name:

IPv6 Address: ▼

Apply

Management Time & Schedule Time

The Time page allows you to configure, update, and maintain the correct time on the internal system clock. From here you can set the time zone, the Network Time Protocol (NTP) server, and enable or disable daylight saving time.

In the Management menu on the bar on the top of the page, click **Time & Schedule**.

Time Configuration

Time Zone: Select your time zone from the drop-down menu.

Time: Displays the current date and time of the router.

Daylight Saving: Enable or disable daylight saving time.

Automatic Time Configuration

Update Time Using an NTP Server: Enable or disable to allow an NTP server on the Internet to synchronize the time and date with your router. If you enable this option, select an NTP server from the drop-down menu. To configure the router's time and date manually, disable this option and use the drop-down menus that appear to input the time and date.

Click **Save** when you are done.

To configure and manage your schedules, click **Schedule** and refer to page 84.

Schedule

Some configuration rules can be set according to a pre-configured schedule. To create, edit, or delete schedules, from the Time page click **Schedule**. To return to the Time page, click **Time**.

If you wish to remove a rule, click on its trash can icon in the Delete column. If you wish to edit a rule, click on its pencil icon in the Edit column. If you wish to create a new rule, click the **Add Rules** button. Click **Save** when you are done. If you edit or create a rule, the following screen will appear:

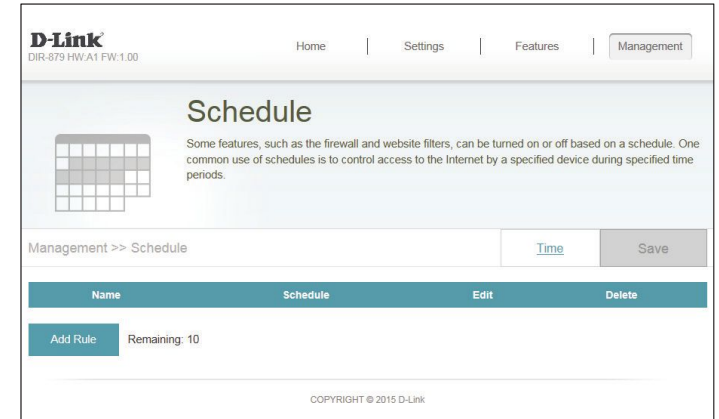

First, enter the name of your schedule in the **Name** field.

Each box represents one hour, with the time at the top of each column. To add a time period to the schedule, simply click on the start hour and drag to the end hour. You can add multiple days to the schedule, but only one period per day.

To remove a time period from the schedule, click on the cross icon.

Click **Apply** when you are done.

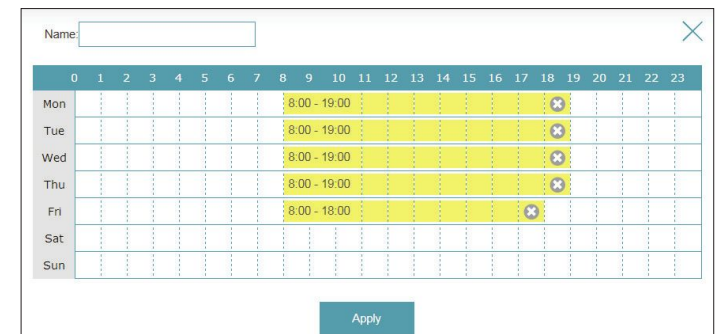
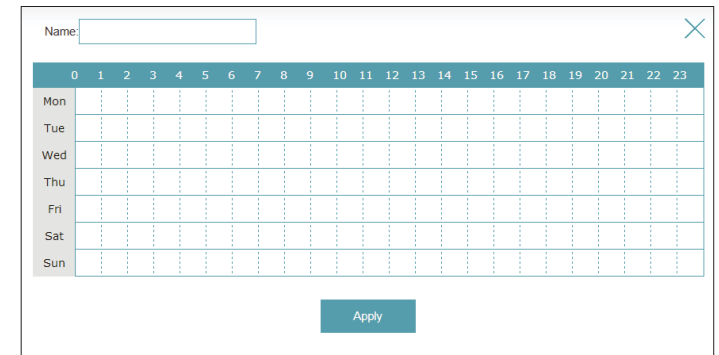

System Log

The router keeps a running log of events. This log can be sent to a Syslog server, and sent to your email address. In the Management menu on the bar on the top of the page, click **System Log**.

SysLog Settings

Enable Logging to Syslog Server: Check this box to send the router logs to a SysLog Server.

If Logging to the Syslog Server is **Enabled**:

Syslog Server IP Address: Enter the IP address for the Syslog server. If the Syslog server is connected to the extender, select it from the drop-down menu to automatically populate the field.

Email Settings

Enable Email Notification: If you want the logs to be automatically sent to an email address, enable this option.

If Email notification is **Enabled**:

From E-mail Address: Enter the email address your SysLog messages will be sent from.

To E-mail Address: Enter the email address your SysLog messages will be sent to.

SMTP Server Address: Enter your SMTP server address.

SMTP Server Port: Enter your SMTP server port.

Enable Authentication: Check this box if your SMTP server requires authentication.

Account Name: Enter your SMTP account name.

Password: Enter your SMTP account name's password.

E-mail Log When Full or On Schedule

Send On Schedule: If email notification is enabled, this option will set the router to send the log by email when the log is full.

Schedule: This option can be enabled to send an email according to a preconfigured schedule. See below.

If you enable **On Schedule** is enabled, use the drop-down menu to select the time schedule that the rule will be enabled on. The schedule may be set to **Always Enable**, or you can create your own schedules in the **Schedules** section. Refer to page 84 for more information.

Click **Save** when you are done.

The screenshot shows two sections of a configuration interface. The top section, titled "E-mail Settings", contains the following fields: "Enable E-mail Notification" (checkbox checked, labeled "Enabled"), "From E-mail Address:" (text input), "To E-mail Address:" (text input), "SMTP Server Address:" (text input), "SMTP Server Port:" (text input with "25" entered), "Enable Authentication:" (checkbox checked, labeled "Enabled"), "Account Name:" (text input), and "Password:" (text input). The bottom section, titled "E-mail Log When Full or On Schedule", contains: "Send When Log Full:" (checkbox checked, labeled "Enabled"), "Send on Schedule:" (checkbox checked, labeled "Enabled"), and "Schedule:" (dropdown menu with "Always Enable" selected).

Admin

This page will allow you to change the administrator (Admin) password and enable remote management. In the Management menu on the bar on the top of the page, click **Admin**. To load, save, reset settings, or reboot the router, click **System** and refer to page 88.

Admin Password

Password: Enter a new password for the administrator account. You will need to enter this password whenever you configure the router using a web browser.

Enable Graphical Authentication (CAPTCHA): Enables a challenge-response test to require users to type letters or numbers from a distorted image displayed on the screen to prevent online hackers and unauthorized users from gaining access to your router's network settings.

Advanced Settings - Administration

Enable HTTPS Server: Check to enable HTTPS to connect to the router securely. Instead of using **http://dlinkrouter.local./**, you must use **https://dlinkrouter.local./** in order to connect to the router.

Enable Remote Management: Remote management allows the DIR-879 to be configured from the Internet by a web browser. A password is still required to access the web management interface.

Remote Admin Port: The port number used to access the DIR-879 is used in the URL. Example: **http://x.x.x.x:8080** where x.x.x.x is the Internet IP address of the DIR-879 and 8080 is the port used for the web management interface.
Note: If you enabled **HTTPS Server** and wish to access the router remotely and securely, you must enter **https://** at the beginning of the address.

Click **Save** when you are done.

The screenshot shows the D-Link DIR-879 Admin interface. At the top, there is a navigation bar with 'Home', 'Settings', 'Features', and 'Management'. The 'Management' menu is active, and the 'Admin' page is displayed. The page title is 'Admin' and it includes a key icon and a warning: 'The admin account can change all router settings. To keep your router secure, you should give the admin account a strong password.' Below this, there are two tabs: 'System' and 'Save'. The 'Admin Password' section contains a 'Password' field with a masked input, an 'Enable Graphical Authentication (CAPTCHA)' checkbox (checked), and an 'Advanced Settings...' link. The 'Administration' section contains three checkboxes: 'Enable HTTPS Server' (checked), 'Enable Remote Management' (checked), and 'Use HTTPS' (checked). There is also a 'Remote Admin Port' field with the value '8081'. At the bottom, there is a copyright notice: 'COPYRIGHT © 2015 D-Link'.

System

This page allows you to save the router's current configuration, load a previously saved configuration, reset the router to its factory default settings, or reboot the router.

From the Admin page, click **System**. To return to the Admin page, click **Admin**.

System

Save Settings To Local Hard Drive: This option will save the current router configuration settings to a file on your computer.

Load Settings From Local Hard Drive: This option will load a previously saved router configuration file. This will overwrite the router's current configuration.

Restore To Factory Default Settings: This option will restore all configuration settings back to the settings that were in effect at the time the router was shipped from the factory. Any settings that have not been saved will be lost, including any rules that you have created. If you want to save the current router configuration settings, use the **Save Settings To Local Hard Drive** button above.

Reboot The Device: Click to reboot the router immediately.

Click **Save** when you are done.

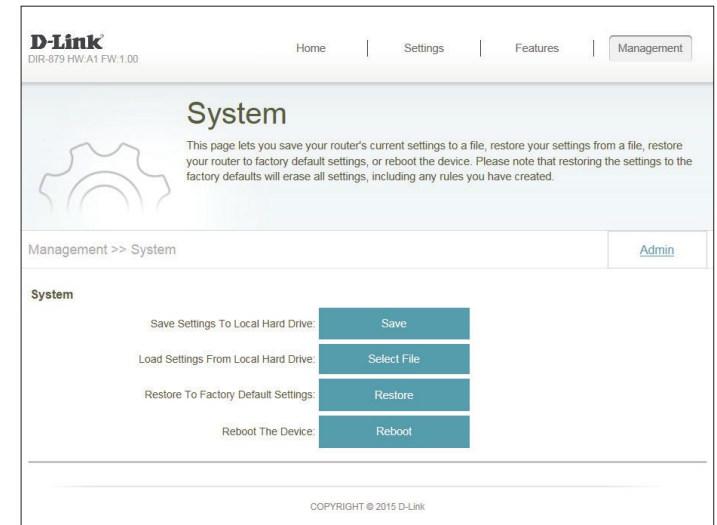

Upgrade

This page will allow you to upgrade the router's firmware or language pack, either automatically or manually. To manually upgrade the firmware or language pack, you must first download the relevant file from <http://support.dlink.com>.

In the Management menu on the bar on the top of the page, click **Upgrade**.

Firmware

Firmware Information: The current firmware's version and date will be displayed.

Check for New Firmware: Click this button to prompt the router to automatically check for a new firmware version. If a newer version is found, it will prompt you to install it.

Upgrade Manually

Upgrade Firmware: If you wish to upgrade manually, first download the firmware file you wish to upgrade to. Next, click the **Upgrade Firmware** button and browse to the file to install the new firmware. You can also browse to a language pack file to install a new language pack.

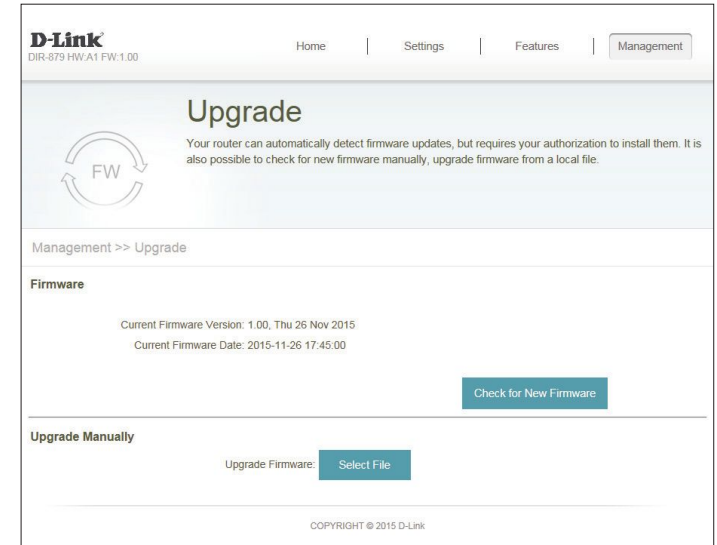

Statistics

On the Statistics page you can view the amount of packets that pass through the router on the WAN, LAN, and wireless segments.

In the Management menu on the bar on the top of the page, click **Statistics**.

You can view the **Internet**, **LAN**, **Wi-Fi 2.4 GHz**, or **Wi-Fi 5 GHz** by clicking on the respective tabs at the top. The graph will update in real time. To clear the information on the graph, click **Clear**.

The traffic counter will reset if the device is rebooted.

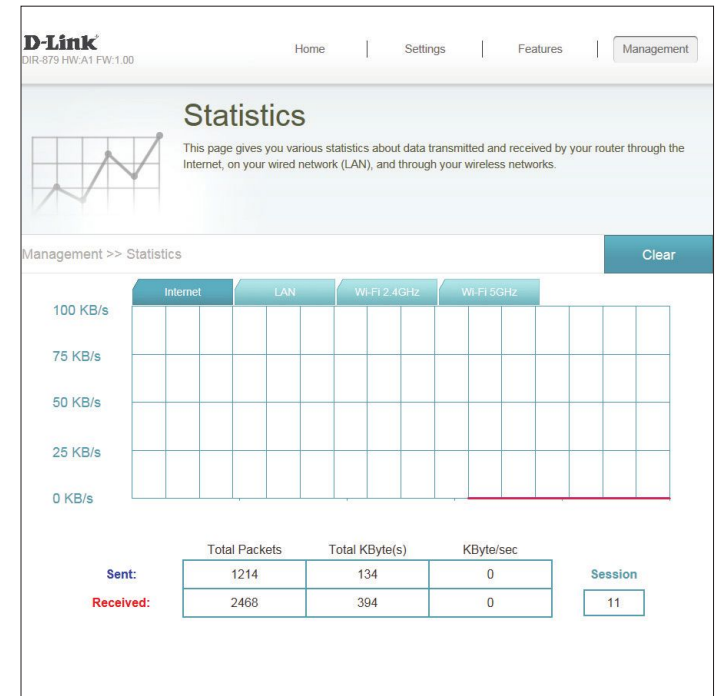

Configuration - Extender Mode - Access Point Settings

To access the configuration utility, open a web-browser such as Internet Explorer and enter **http://dlinkrouter.local/** or you may also connect by typing the IP address* of the DIR-879 in the address bar.

* By default the DIR-879 in extender mode will use DHCP to obtain an IP address from your uplink network. If you are using multiple DIR-879s or D-Link devices, go to **http://dlinkrouterxxxx.local/** as shown on the included Wi-Fi Configuration Card, with "xxxx" being the last four digits of the DIR-879's MAC address. The MAC address is also printed on the label on the bottom of the device.

Enter your password. If you previously followed the setup wizard, please use the admin password you entered during the wizard. Otherwise, leave the password blank. Click **Log In** to proceed.

Note: If you cannot remember your password and cannot log in, press the reset/wps button on the back of the device for longer than 10 seconds to restore the router to its default settings.

The Access Point's Wireless Settings page will open, allowing you to easily adjust the wireless network settings.

The bar at the top of the page has quick access to the Home, Settings, and Management functions.

Note: The system will automatically log out after a period of inactivity.

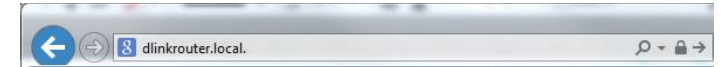
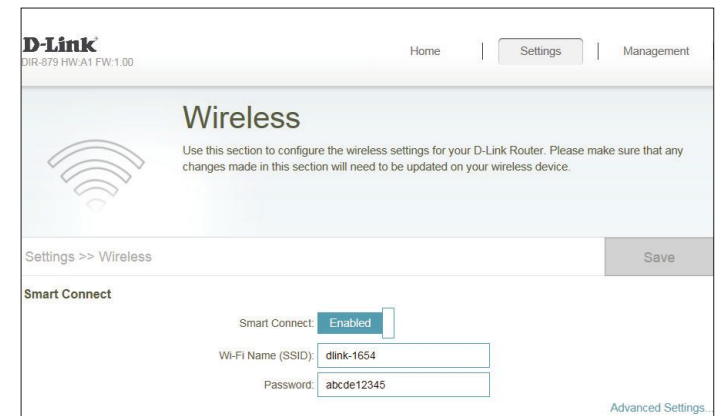
A screenshot of the login page. At the top, it says 'Admin Password:'. Below this is a text input field. At the bottom, there is a blue button labeled 'Log In'.

Wireless

In the Settings menu on the bar on the top of the page, click **Wireless** to see the wireless configuration options. To simplify wireless configuration, Smart Connect is enabled by default. Disable Smart Connect to individually configure 2.4 GHz and 5 GHz modes.

Smart Connect

Smart Connect: Enable or disable the Smart Connect Feature. When enabled only a few configuration options are available.

Wi-Fi Name (SSID): Create a name for your wireless network using up to 32 characters.

Password: Create a password to use for wireless security. Wireless clients will need to enter this password to successfully connect to the network.

Advanced Settings

Security Mode: Choose **None**, **WEP**, or **WPA/WPA2-(Personal)** (recommended).

Transmission Power: Select the desired wireless transmission power.

Schedule: Use the drop-down menu to select the time schedule that the rule will be enabled on. The schedule may be set to **Always Enable**, or you can create your own schedules in the **Schedules** section. Refer to page 84 for more information.

Click **Save** when you are done.

The screenshot displays the D-Link wireless configuration interface. At the top, the D-Link logo and model number 'DIR-879 HW:A1 FW:1.00' are visible. The navigation bar includes 'Home', 'Settings', and 'Management'. The main heading is 'Wireless', with a sub-note: 'Use this section to configure the wireless settings for your D-Link Router. Please make sure that any changes made in this section will need to be updated on your wireless device.' Below this, the breadcrumb 'Settings >> Wireless' is shown next to a 'Save' button. The 'Smart Connect' section has a toggle switch set to 'Enabled'. Underneath, the 'Wi-Fi Name (SSID)' field contains 'dlink-1654' and the 'Password' field contains 'abcde12345'. A link for 'Advanced Settings' is located at the bottom right of this section. The bottom section of the form contains three dropdown menus: 'Security Mode' is set to 'WPA/WPA2-Personal', 'Transmission Power' is set to 'High', and 'Schedule' is set to 'Always Enable'.

Wireless

If Smart Connect is disabled, the following traditional configuration options will become available for both the 2.4 and 5 GHz wireless networks:

2.4GHz / 5GHz

Status: Enable or disable the 2.4 GHz / 5 GHz wireless network.

Wi-Fi Name (SSID): Create a name for your wireless network using up to 32 characters.

Password: Create a password to use for wireless security.

Advanced Settings

Security Mode: Choose **None**, **WEP**, or **WPA/WPA2-(Personal)** (recommended).

802.11 Mode (2.4 GHz): Select the desired wireless networking standards to use. The available options for the 2.4 GHz wireless network are **Mixed 802.11b/g/n**, **Mixed 802.11g/n**, **802.11n only**.

802.11 Mode (5 GHz): Select the desired wireless networking standards to use. The available options for the 5 GHz wireless network are **Mixed 802.11a/n/ac**, **Mixed 802.11n/ac**, **802.11ac only**, **Mixed 802.11a/n**, **Mixed 802.11n only**, or **802.11a only**.

Wi-Fi Channel: Select the desired channel. The default is **Auto** (recommended).

Transmission Power: Select the desired wireless transmission power.

Channel Width (2.4 GHz): Select **Auto 20/40** if you are using both 802.11n and non-802.11n devices, or select **20 MHz** if you are not using any 802.11n devices.

D-Link DIR-879 HW: A1 FW: 1.00 Home Settings Management

Wireless

Use this section to configure the wireless settings for your D-Link Router. Please make sure that any changes made in this section will need to be updated on your wireless device.

Settings >> Wireless Save

Smart Connect Disabled

2.4GHz

Status: Enabled

Wi-Fi Name (SSID):

Password:

Advanced Settings...

Security Mode:

802.11 Mode:

Wi-Fi Channel:

Transmission Power:

Channel Width:

HT20/40 Coexistence: Enabled

Visibility Status:

Schedule:

5GHz

Status: Enabled

Wi-Fi Name (SSID):

Password:

Advanced Settings...

Security Mode:

802.11 Mode:

Wi-Fi Channel:

Transmission Power:

Channel Width:

Visibility Status:

Schedule:

Channel Width (5 GHz): Select **Auto 20/40/80** if you are using 802.11ac, 802.11n, and 802.11a devices, select **Auto 20/40** if you are using 802.11n and 802.11a devices, or select **20 MHz** if you are only using 802.11a devices.

HT20/40 Coexistence: Enable or disable HT20/40 Coexistence.

Visibility Status: The default setting is **Visible**. Select **Invisible** if you do not want to broadcast the SSID of your wireless network.

Schedule: Use the drop-down menu to select the time schedule that the rule will be enabled on. The schedule may be set to **Always Enable**, or you can create your own schedules in the **Schedules** section. Refer to page 100 for more information.

Click **Save** when you are done.

The screenshot shows the configuration interface for the 5GHz network. At the top, the title is "5GHz". Below it, there is a "Status" field set to "Enabled". The "Wi-Fi Name (SSID)" is "dlink-1654-5GHz" and the "Password" is "abcde12345". There is a link for "Advanced Settings" on the right. Below these fields are several dropdown menus: "Security Mode" is set to "WPA/WPA2-Personal", "802.11 Mode" is "Mixed 802.11a/n/ac", "Wi-Fi Channel" is "Auto", "Transmission Power" is "High", "Channel Width" is "Auto 20/40/80 MHz", "Visibility Status" is "Visible", and "Schedule" is "Always Enable".

Network

This section will allow you to change the local network settings of the extender and to configure the device's connection to the uplink network. In the Settings menu on the bar on the top of the page, click **Network**. Click **Advanced Settings...** to expand the list and see all of the options.

Network Settings

Management Link: The default address to access the extender's configuration is **http://dlinkrouter.local/**. Here, you can replace **dlinkrouter** with a name of your choice.

Advanced Settings - IPv4 Device Management Interface

My LAN Connection Is: Choose the IPv4 provisioning mechanism used by the extender. Select either **Dynamic IP (DHCP)** or **Static IP**. The Default is Dynamic IP.

If you change the connection type to **Static IP**, configure the following options:

IP Address: Enter the IP address of the extender. If you change the IP address, once you click **Save**, you will need to enter the new IP address in your browser to get back into the configuration utility

Subnet Mask: Enter the subnet mask of the extender. The default subnet mask is **255.255.255.0**.

Gateway Address: Enter the IP address of the device the Extender connects to.

Primary DNS Server: Enter the primary DNS server IP address assigned by your ISP. If you do not know it, enter the Gateway Address.

Secondary DNS Server: Enter the secondary DNS server IP address assigned by your ISP. If you do not know it, enter the Gateway Address.

Click **Save** when you are done.

Home

The Home page displays the current status of the extender in the form of an interactive diagram. You can click each icon to display information about each part of the network at the bottom of the screen. The menu bar at the top of the page will allow you to quickly navigate to other pages.

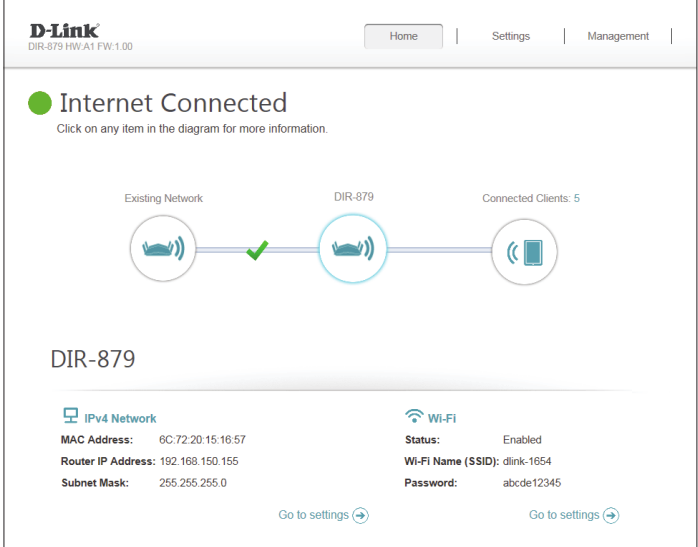

The screenshot shows the D-Link DIR-879 Home page. At the top, there is a navigation bar with 'Home', 'Settings', and 'Management' tabs. The main content area features a green circle icon and the text 'Internet Connected'. Below this, a diagram shows an 'Existing Network' (represented by a laptop icon) connected to a 'DIR-879' (represented by a router icon) with a green checkmark, which is then connected to 'Connected Clients: 5' (represented by a smartphone icon). Below the diagram, there are two sections: 'IPv4 Network' and 'Wi-Fi'. The IPv4 Network section lists: MAC Address: 6C:72:20:15:16:57, Router IP Address: 192.168.150.155, and Subnet Mask: 255.255.255.0. The Wi-Fi section lists: Status: Enabled, Wi-Fi Name (SSID): dlink-1654, and Password: abcde12345. Both sections have a 'Go to settings' link with a right-pointing arrow.

The Home page displays whether or not the extender is currently connected to the Internet. If it is disconnected, click the red X between the existing network and the DIR-879 to bring up the setup wizard, refer to page 32 for more information.

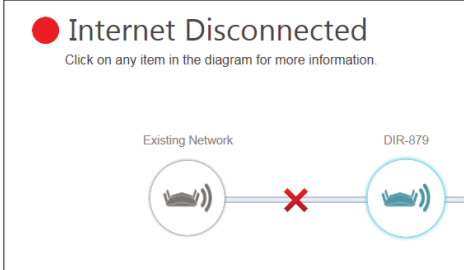

The screenshot shows the D-Link DIR-879 Home page with a red circle icon and the text 'Internet Disconnected'. Below this, a diagram shows an 'Existing Network' (represented by a laptop icon) connected to a 'DIR-879' (represented by a router icon) with a red X between them, indicating a disconnection.

DIR-879

To bring up more details about the connection to your existing network, click on the **DIR-879** icon. Your **Network** and **Wireless Network** settings are displayed at the bottom of the page.

Your Extender's MAC address, IPv4 address, and subnet mask are displayed. To reconfigure the Network settings, refer to page 93.

If Smart Connect is enabled your wireless network status, name, and password is shown. If Smart Connect is disabled your wireless network statuses, names, and passwords for both the 2.4 GHz and 5 GHz networks are shown. To reconfigure the Wireless settings, refer to page 91.

The screenshot shows the D-Link DIR-879 web interface. At the top, there is a navigation bar with 'Home', 'Settings', and 'Management' tabs. Below the navigation bar, a green circle indicates 'Internet Connected' with a subtext 'Click on any item in the diagram for more information.' A network diagram shows 'Existing Network' connected to 'DIR-879', which is then connected to 'Connected Clients: 5'. Below the diagram, the 'DIR-879' settings are displayed in two columns:

IPv4 Network	Wi-Fi
MAC Address: 6C:72:20:15:16:57	Status: Enabled
Router IP Address: 192.168.150.155	Wi-Fi Name (SSID): dlink-1654
Subnet Mask: 255.255.255.0	Password: abcde12345
Go to settings	Go to settings

The screenshot shows the D-Link DIR-879 web interface with detailed wireless settings. The 'DIR-879' settings are displayed in two columns:

IPv4 Network	Wi-Fi 2.4GHz	Wi-Fi 5GHz
MAC Address: 6C:72:20:15:16:57	Status: Enabled	Status: Enabled
Router IP Address: 192.168.150.155	Wi-Fi Name (SSID): dlink-1654	Wi-Fi Name (SSID): dlink-1654-5GHz
Subnet Mask: 255.255.255.0	Password: abcde12345	Password: abcde12345
Go to settings		Go to settings

Connected Clients

Click on the **Connected Clients** icon to view details about the extender and its wireless settings.

On this page you can see all the clients currently connected to the extender, and their IP addresses.

To edit each client's settings, click the pencil icon on the client you want to edit.

Name: Enter a custom name for this client.

Vendor: Displays the vendor of the device.

MAC Address: Displays the MAC address of the device.

IP Address: Displays the IP address of the device.

Click **Save** when you are done.

D-Link
DIR-879 HW:A1 FW:1.00

Home | Settings | Management

Internet Connected
Click on any item in the diagram for more information.

Existing Network — DIR-879 — Connected Clients: 5

Connected Clients

You can block a device from accessing your network completely.

08203PCWIN7 Unknown Vendor 192.168.150.115	Unknown Unknown Vendor 192.168.150.23	Unknown Unknown Vendor 192.168.150.1
08203PCWIN7 Universal Global Sc. 192.168.150.50	Unknown D-Link 192.168.150.29	

Edit Rule ✕

Name: 08203PCWIN7

Vendor: Unknown Vendor

MAC Address: 3c:1e:04:f3:b6:49

IP Address: 192.168.150.115

Save

Management Time & Schedule Time

The Time page allows you to configure, update, and maintain the correct time on the internal system clock. From here you can set the time zone, the Network Time Protocol (NTP) server, and enable or disable daylight saving time.

In the Management menu on the bar on the top of the page, click **Time & Schedule**.

Time Configuration

Time Zone: Select your time zone from the drop-down menu.

Time: Displays the current date and time of the router.

Daylight Saving: Enable or disable daylight saving time.

Automatic Time Configuration

Update Time Using an NTP Server: Enable or disable to allow an NTP server on the Internet to synchronize the time and date with your router. If you enable this option, select an NTP server from the drop-down menu. To configure the router's time and date manually, disable this option and use the drop-down menus that appear to input the time and date.

Click **Save** when you are done.

To configure and manage your schedules, click **Schedule** and refer to page 100.

D-Link
DIR-879 HW:A1 FW:1.00

Home | Settings | Management

Time

Your router's internal clock is used for data logging and schedules for features. The date and time can be synchronized with a public time server on the Internet, or set manually.

Management >> System Time Schedule Save

Time Configuration

Time Zone: (GMT-05:00) Eastern Time (US & Canada) ▼

Time: 2015/12/21 01:48:22 AM

Enable Daylight Saving: Disabled

Automatic Time Configuration

Update Time Using an NTP Server: Enabled

NTP Server: D-Link NTP Server ▼

Automatic Time Configuration

Update Time Using an NTP Server: Disabled

Manual Time Configuration

Date: 2016 ▼ 02 ▼ 03 ▼ (Year/ Month/ Day)

Time: 11 ▼ 44 ▼ (Hour/ Minute)

Schedule

Some configuration rules can be set according to a pre-configured schedule. To create, edit, or delete schedules, from the Time page click **Schedule**. To return to the Time page, click **Time**.

If you wish to remove a rule, click on its trash can icon in the Delete column. If you wish to edit a rule, click on its pencil icon in the Edit column. If you wish to create a new rule, click the **Add Rules** button. Click **Save** when you are done. If you edit or create a rule, the following screen will appear:

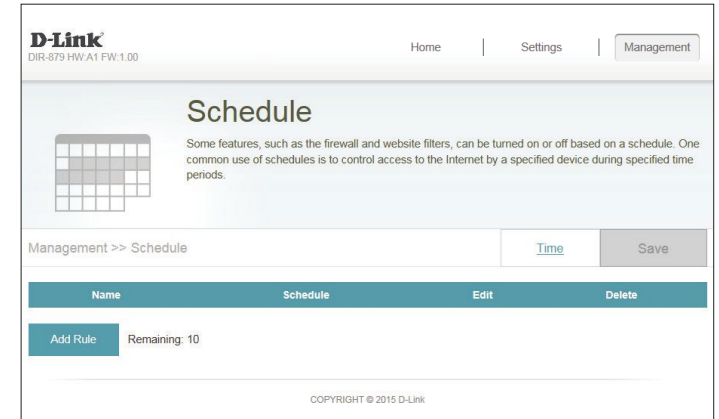

First, enter the name of your schedule in the **Name** field.

Each box represents one hour, with the time at the top of each column. To add a time period to the schedule, simply click on the start hour and drag to the end hour. You can add multiple days to the schedule, but only one period per day.

To remove a time period from the schedule, click on the cross icon.

Click **Apply** when you are done.

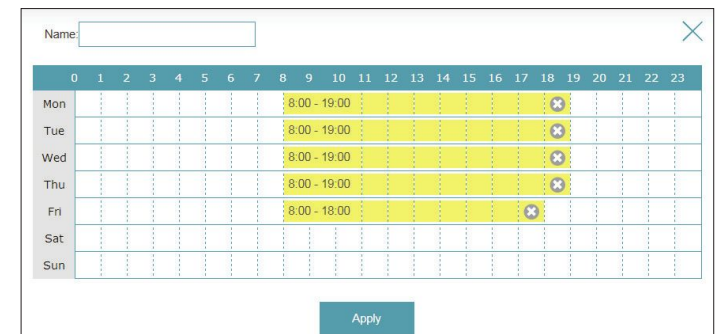
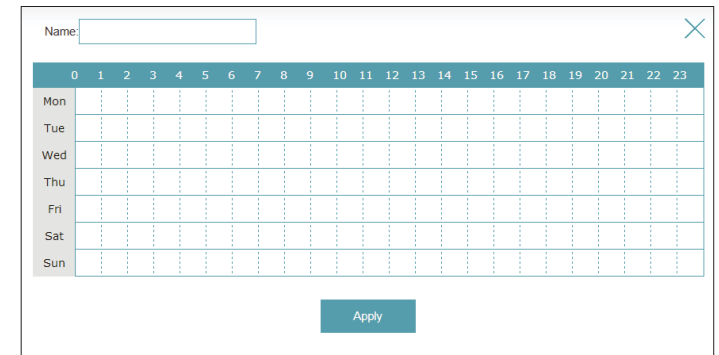

System Log

The router keeps a running log of events. This log can be sent to a Syslog server, and sent to your email address. In the Management menu on the bar on the top of the page, click **System Log**.

SysLog Settings

Enable Logging to Syslog Server: Check this box to send the router logs to a SysLog Server.

If Logging to the Syslog Server is **Enabled**:

Syslog Server IP Address: Enter the IP address for the Syslog server. If the Syslog server is connected to the extender, select it from the drop-down menu to automatically populate the field.

Email Settings

Enable Email Notification: If you want the logs to be automatically sent to an email address, enable this option.

If Email notification is **Enabled**:

From E-mail Address: Enter the email address your SysLog messages will be sent from.

To E-mail Address: Enter the email address your SysLog messages will be sent to.

SMTP Server Address: Enter your SMTP server address.

SMTP Server Port: Enter your SMTP server port.

Enable Authentication: Check this box if your SMTP server requires authentication.

D-Link
DIR-879 HW:A1 FW:1.00

Home | Settings | Management

System Log

On-board diagnostics run continually in the background to monitor the health of your router. The results are recorded in the system log if it is enabled. This info can be used to diagnose common problems or help Customer Support resolve issues more quickly.

Management >> System Log Save

SysLog Settings

Enable Logging to Syslog Server: Disabled

SysLog Settings

Enable Logging to Syslog Server: Enabled

SysLog Server IP Address: << Computer Name

E-mail Settings

Enable E-mail Notification: Disabled

E-mail Settings

Enable E-mail Notification: Enabled

From E-mail Address:

To E-mail Address:

SMTP Server Address:

SMTP Server Port: 25

Enable Authentication: Enabled

Account Name:

Password:

E-mail Log When Full or On Schedule

Send When Log Full: Enabled

Send on Schedule: Enabled

Schedule: Always Enable

Account Name: Enter your SMTP account name.

Password: Enter your SMTP account name's password.

E-mail Log When Full or On Schedule

Send On Schedule: If email notification is enabled, this option will set the router to send the log by email when the log is full.

Schedule: This option can be enabled to send an email according to a preconfigured schedule. See below.

If you enable **On Schedule** is enabled, use the drop-down menu to select the time schedule that the rule will be enabled on. The schedule may be set to **Always Enable**, or you can create your own schedules in the **Schedules** section. Refer to page 100 for more information.

Click **Save** when you are done.

The screenshot shows two configuration sections. The top section, titled "E-mail Settings", includes: "Enable E-mail Notification" (Enabled), "From E-mail Address:" (text input), "To E-mail Address:" (text input), "SMTP Server Address:" (text input), "SMTP Server Port:" (25), "Enable Authentication:" (Enabled), "Account Name:" (text input), and "Password:" (text input). The bottom section, titled "E-mail Log When Full or On Schedule", includes: "Send When Log Full:" (Enabled), "Send on Schedule:" (Enabled), and "Schedule:" (Always Enable dropdown menu).

Admin

This page will allow you to change the administrator (Admin) password and enable remote management. In the Management menu on the bar on the top of the page, click **Admin**. To load, save, reset settings, or reboot the router, click **System** and refer to page 104.

Admin Password

Password: Enter a new password for the administrator account. You will need to enter this password whenever you configure the router using a web browser.

Enable Graphical Authentication (CAPTCHA): Enables a challenge-response test to require users to type letters or numbers from a distorted image displayed on the screen to prevent online hackers and unauthorized users from gaining access to your router's network settings.

Advanced Settings - Administration

Enable HTTPS Server: Check to enable HTTPS to connect to the router securely. Instead of using **http://dlinkrouter.local./**, you must use **https://dlinkrouter.local./** in order to connect to the router.

Click **Save** when you are done.

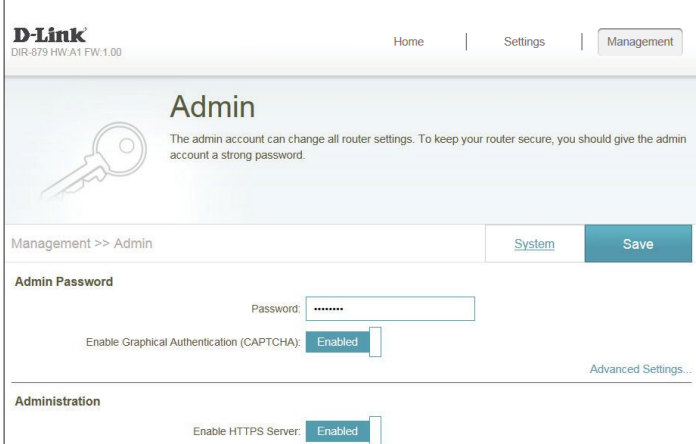

The screenshot shows the D-Link Admin interface for a DIR-879 HW.A1 FW:1.00. The top navigation bar includes 'Home', 'Settings', and 'Management'. The main heading is 'Admin', with a sub-note: 'The admin account can change all router settings. To keep your router secure, you should give the admin account a strong password.' Below this, there are two buttons: 'System' and 'Save'. The 'Admin Password' section contains a 'Password:' input field with masked characters, and a toggle for 'Enable Graphical Authentication (CAPTCHA)' which is currently 'Enabled'. An 'Advanced Settings...' link is visible to the right. The 'Administration' section has a toggle for 'Enable HTTPS Server' which is also 'Enabled'.

System

This page allows you to save the router's current configuration, load a previously saved configuration, reset the router to its factory default settings, or reboot the router.

From the Admin page, click **System**. To return to the Admin page, click **Admin**.

System

Save Settings To Local Hard Drive: This option will save the current router configuration settings to a file on your computer.

Load Settings From Local Hard Drive: This option will load a previously saved router configuration file. This will overwrite the router's current configuration.

Restore To Factory Default Settings: This option will restore all configuration settings back to the settings that were in effect at the time the router was shipped from the factory. Any settings that have not been saved will be lost, including any rules that you have created. If you want to save the current router configuration settings, use the **Save Settings To Local Hard Drive** button above.

Reboot The Device: Click to reboot the router immediately.

Click **Save** when you are done.

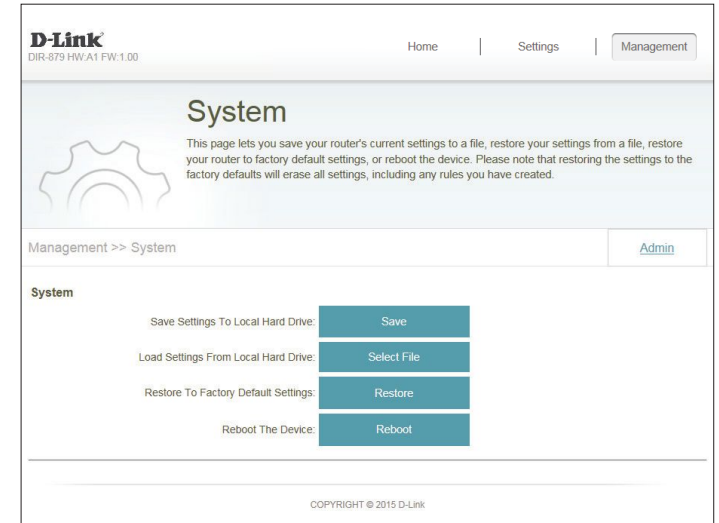

Upgrade

This page will allow you to upgrade the router's firmware or language pack, either automatically or manually. To manually upgrade the firmware or language pack, you must first download the relevant file from **http://support.dlink.com**.

In the Management menu on the bar on the top of the page, click **Upgrade**.

Firmware

Firmware Information: The current firmware's version and date will be displayed.

Check for New Firmware: Click this button to prompt the router to automatically check for a new firmware version. If a newer version is found, it will prompt you to install it.

Upgrade Manually

Upgrade Firmware: If you wish to upgrade manually, first download the firmware file you wish to upgrade to. Next, click the **Upgrade Firmware** button and browse to the file to install the new firmware. You can also browse to a language pack file to install a new language pack.

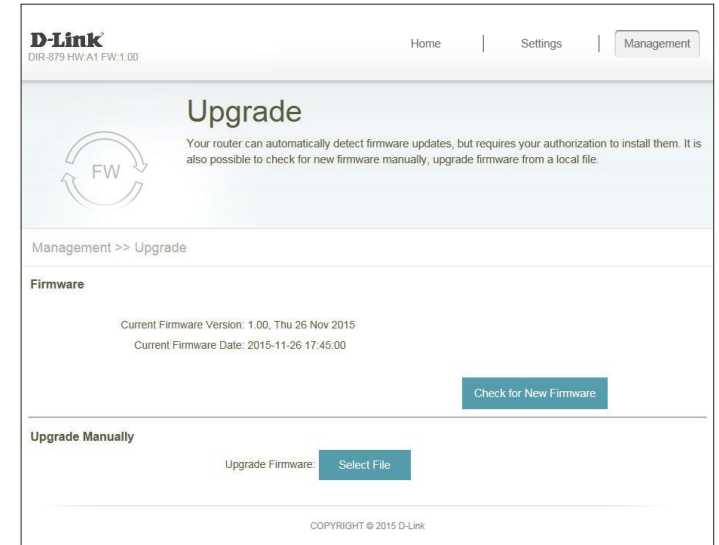

Connect a Wireless Client to your Router

WPS Button

The easiest and most secure way to connect your wireless devices to the router is with WPS (Wi-Fi Protected Setup). Most wireless devices such as wireless adapters, media players, Blu-ray DVD players, wireless printers and cameras will have a WPS button (or a software utility with WPS) that you can press to connect to the DIR-879 router. Please refer to your user manual for the wireless device you want to connect to make sure you understand how to enable WPS. Once you know, follow the steps below:

Step 1 - Press the WPS button on the DIR-879 for about 1 second. The LED on the front will start to blink.



WPS Button

Step 2 - Within 2 minutes, press the WPS button on your wireless device (or launch the software utility and start the WPS process).

Step 3 - Allow up to 1 minute for your connection to be configured. Once the Internet light stops blinking, you will be connected and your wireless connection will be secure with WPA2.

Windows® 10

When connecting to the DIR-879 wirelessly for the first time, you will need to input the wireless network name (SSID) and Wi-Fi password (security key) of the device you are connecting to. If your product has a Wi-Fi configuration card, you can find the default network name and Wi-Fi password here. Otherwise refer to the product label for the default Wi-Fi network SSID and password, or enter the Wi-Fi credentials set during the product configuration.

To join an existing network, locate the wireless network icon in the taskbar, next to the time display and click on it.

Clicking on this icon will display a list of wireless networks which are within range of your computer. Select the desired network by clicking on the SSID.



Wireless Icon

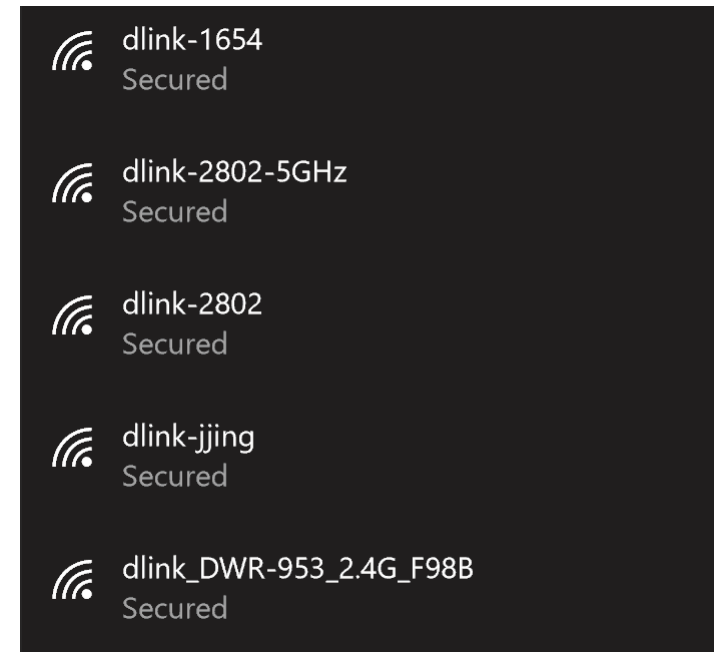

To connect to the SSID, click **Connect**.

To automatically connect with the router when your device next detects the SSID, click the **Connect Automatically** check box.

You will then be prompted to enter the Wi-Fi password (network security key) for the wireless network. Enter the password into the box and click **Next** to connect to the network. Your computer will now automatically connect to this wireless network when it is detected.

You can also use Wi-Fi Protected Setup (WPS) to connect to the router. Press the WPS button on your D-Link device and you will be automatically connected.

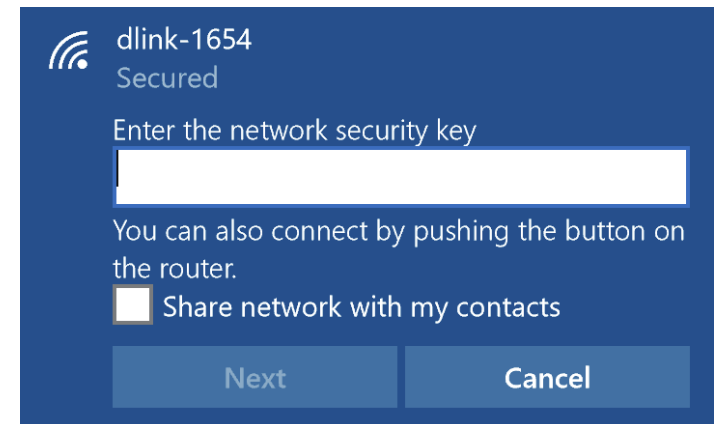
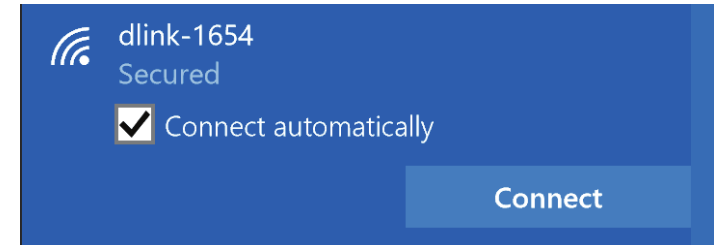

Windows® 8

WPA/WPA2

It is recommended that you enable wireless security (WPA/WPA2) on your wireless router or access point before configuring your wireless adapter. If you are joining an existing network, you will need to know the security key (Wi-Fi password) being used.

To join an existing network, locate the wireless network icon in the taskbar next to the time display.



Clicking on this icon will display a list of wireless networks that are within connecting proximity of your computer. Select the desired network by clicking on the network name.

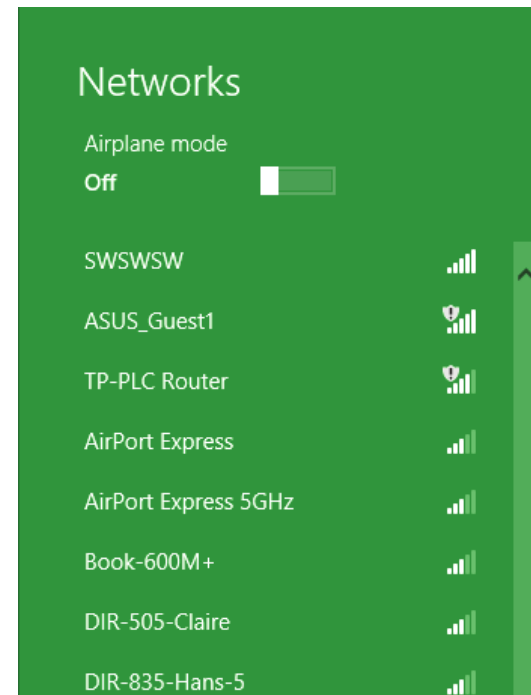

You will then be prompted to enter the network security key (Wi-Fi password) for the wireless network. Enter the password into the box and click **Next**.

If you wish to use Wi-Fi Protected Setup (WPS) to connect to the router, you can also press the WPS button on your router during this step to enable the WPS function.

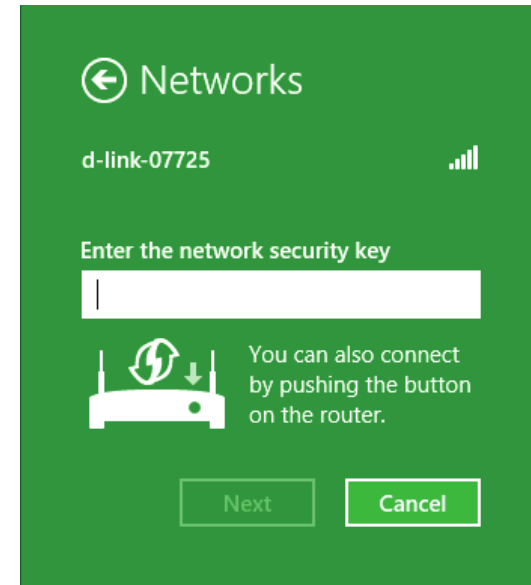

When you have established a successful connection to a wireless network, the word **Connected** will appear next to the name of the network to which you are connected to.

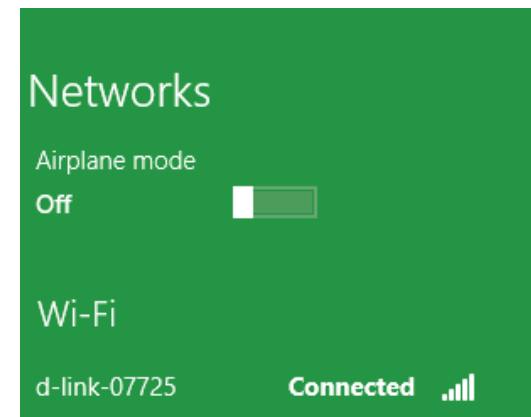

Windows® 7

WPA/WPA2

It is recommended that you enable wireless security (WPA/WPA2) on your wireless router or access point before configuring your wireless adapter. If you are joining an existing network, you will need to know the security key or passphrase being used.

1. Click on the wireless icon in your system tray (lower-right corner).



Wireless Icon

2. The utility will display any available wireless networks in your area.



3. Highlight the wireless connection with Wi-Fi name (SSID) you would like to connect to and click the **Connect** button.

If you get a good signal but cannot access the Internet, check your TCP/IP settings for your wireless adapter. Refer to the Networking Basics section in this manual for more information.



4. The following window appears while your computer tries to connect to the router.

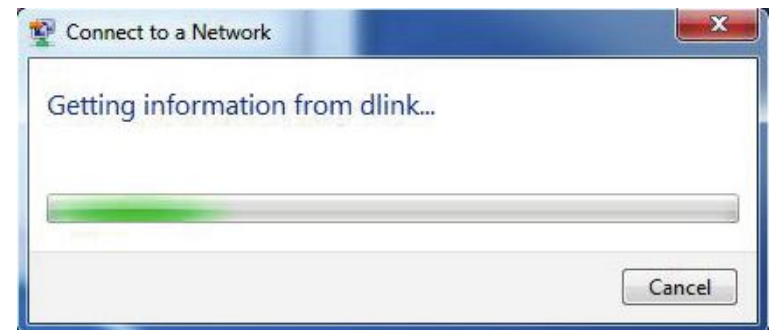

5. Enter the same security key or passphrase (Wi-Fi password) that is on your router and click **Connect**. You can also connect by pushing the WPS button on the router.

It may take 20-30 seconds to connect to the wireless network. If the connection fails, please verify that the security settings are correct. The key or passphrase must be exactly the same as the one on the wireless router.

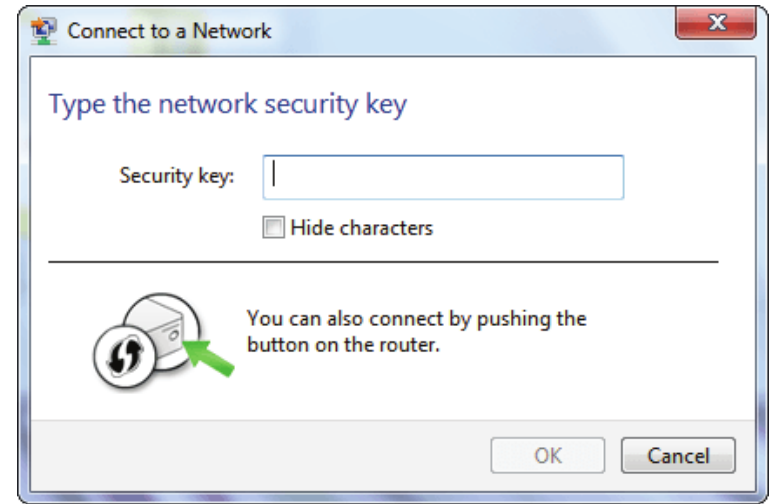

WPS

The WPS feature of the DIR-879 can be configured using Windows® 7. Carry out the following steps to use Windows® 7 to configure the WPS feature:

1. Click the **Start** button and select **Computer** from the Start menu.

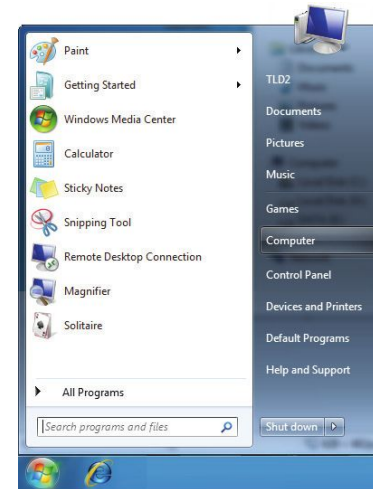

2. Click **Network** on the left side.

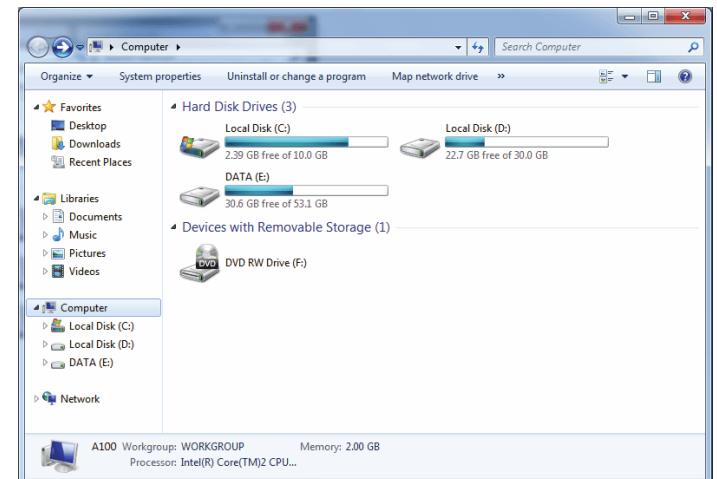

3. Double-click the DIR-879.

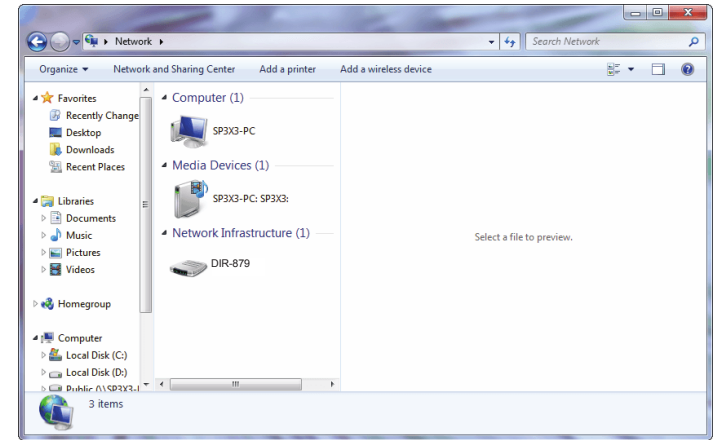

4. Input the WPS PIN number (on the router label) in the **Setup > Wireless Setup** menu in the Router's Web UI) and click **Next**.

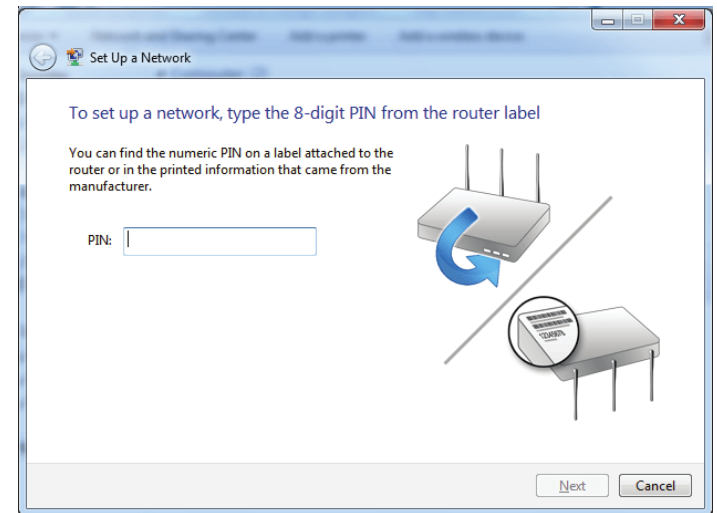

5. Type a name to identify the network.

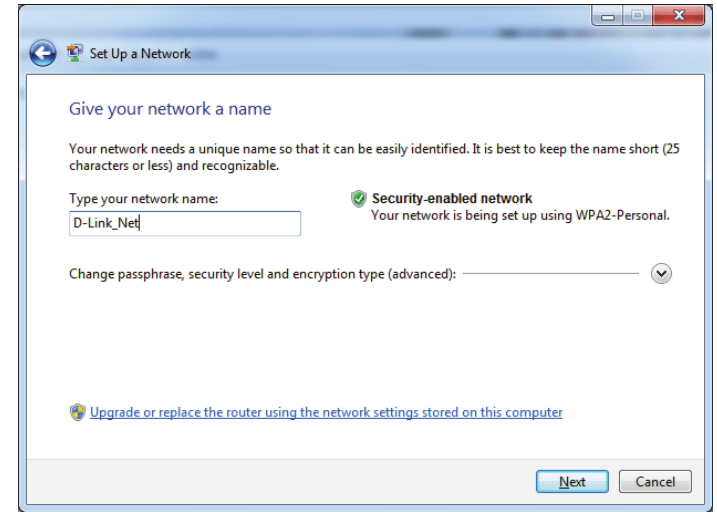

6. To configure advanced settings, click the  icon.

Click **Next** to continue.

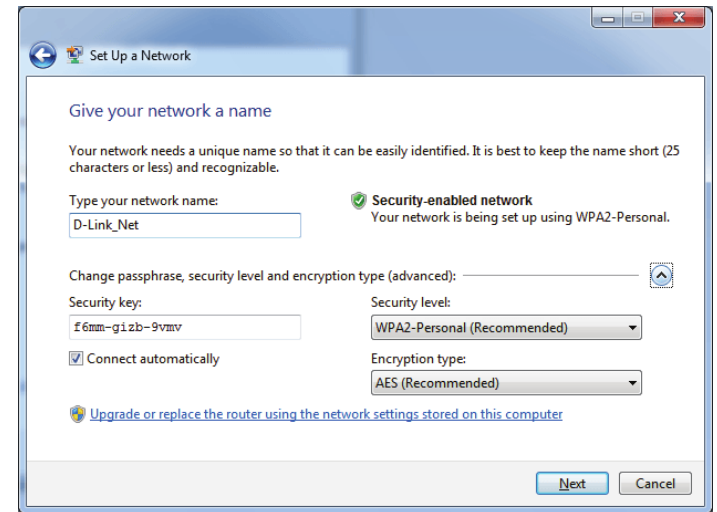

7. The following window appears while the DIR-879 is being configured.

Wait for the configuration to complete.

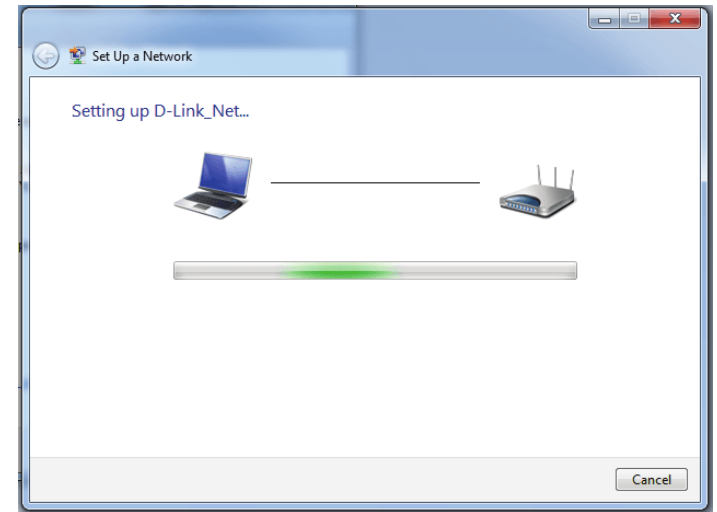

8. The following window informs you that WPS on the DIR-879 has been set up successfully.

Make a note of the security key as you may need to provide this security key if adding an older wireless device to the network in the future.

9. Click **Close** to complete WPS setup.

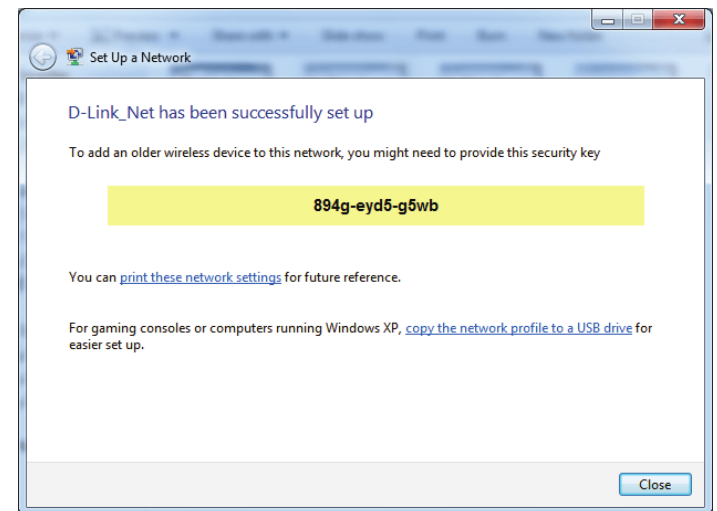

Windows Vista®

Windows Vista® users may use the built-in wireless utility. If you are using another company's wireless utility, please refer to the user manual of your wireless adapter for help connecting to a wireless network. Most wireless utilities will have a "site survey" option similar to the Windows Vista® utility as seen below.

If you receive the **Wireless Networks Detected** bubble, click on the center of the bubble to access the utility.

or

Right-click on the wireless computer icon in your system tray (lower-right corner next to the time). Select **Connect to a network**.



The utility will display any available wireless networks in your area. Click on a network (displayed using the SSID) and click the **Connect** button.

If you get a good signal but cannot access the Internet, check you TCP/IP settings for your wireless adapter. Refer to the **Networking Basics** section in this manual for more information.

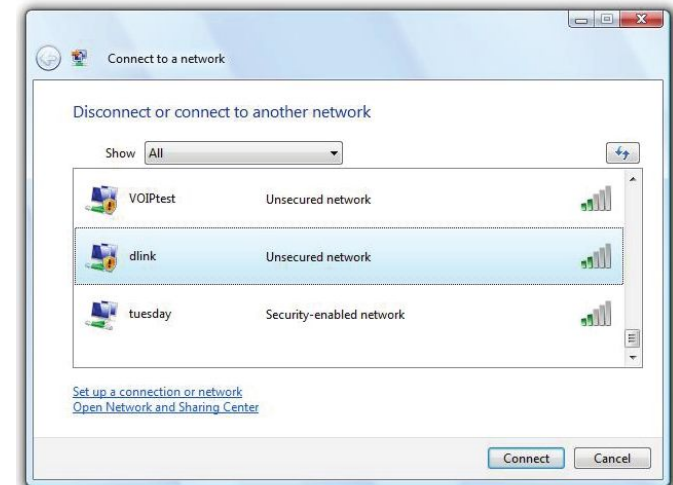

WPA/WPA2

It is recommended that you enable wireless security (WPA/WPA2) on your wireless router or access point before configuring your wireless adapter. If you are joining an existing network, you will need to know the security key or passphrase being used.

1. Open the Windows Vista® Wireless Utility by right-clicking on the wireless computer icon in your system tray (lower right corner of screen). Select **Connect to a network**.



2. Highlight the Wi-Fi name (SSID) you would like to connect to and click **Connect**.

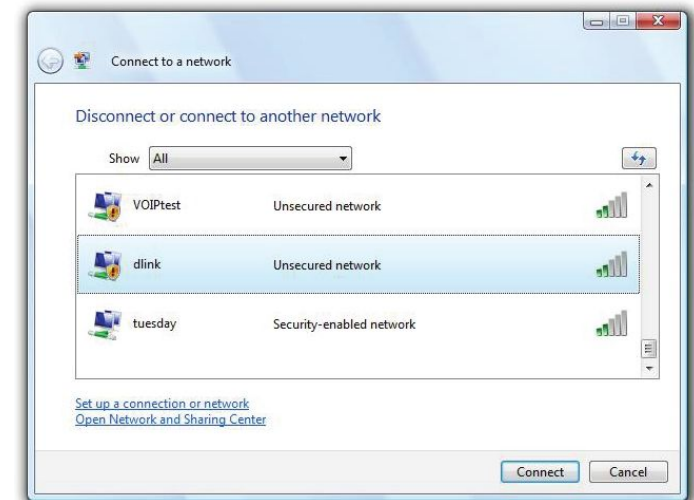

3. Enter the same security key or passphrase (Wi-Fi password) that is on your router and click **Connect**.

It may take 20-30 seconds to connect to the wireless network. If the connection fails, please verify that the security settings are correct. The key or passphrase must be exactly the same as the one on the wireless router.



Troubleshooting

This chapter provides solutions to problems that can occur during the installation and operation of the DIR-879. Read the following descriptions if you are having problems. The examples below are illustrated in Windows® XP. If you have a different operating system, the screenshots on your computer will look similar to these examples.

1. Why can't I access the web-based configuration utility?

When entering the IP address of the D-Link router (**192.168.0.1** for example), you are not connecting to a website, nor do you have to be connected to the Internet. The device has the utility built-in to a ROM chip in the device itself. Your computer must be on the same IP subnet to connect to the web-based utility.

- Make sure you have an updated Java-enabled web browser. We recommend the following:
 - Internet Explorer® 11 or higher
 - Firefox 20 or higher
 - Safari 7 or higher
 - Chrome 25 or higher
- Verify physical connectivity by checking for solid link lights on the device. If you do not get a solid link light, try using a different cable, or connect to a different port on the device if possible. If the computer is turned off, the link light may not be on.
- Disable any Internet security software running on the computer. Software firewalls such as ZoneAlarm, BlackICE, Sygate, Norton Personal Firewall, and Windows® XP firewall may block access to the configuration pages. Check the help files included with your firewall software for more information on disabling or configuring it.

- Configure your Internet settings:
 - Go to **Start > Settings > Control Panel**. Double-click the **Internet Options** icon. From the **Security** tab, click the button to restore the settings to their defaults.
 - Click the **Connection** tab and set the dial-up option to Never Dial a Connection. Click the LAN Settings button. Make sure nothing is checked. Click **OK**.
 - Go to the **Advanced** tab and click the button to restore these settings to their defaults. Click **OK** three times.
 - Close your web browser (if open) and open it.
- Access the web management. Open your web browser and enter the IP address of your D-Link router in the address bar. This should open the login page for your web management.
- If you still cannot access the configuration, unplug the power to the router for 10 seconds and plug back in. Wait about 30 seconds and try accessing the configuration. If you have multiple computers, try connecting using a different computer.

2. What can I do if I forgot my password?

If you forgot your password, you must reset your router. This process will change all your settings back to the factory defaults.

To reset the router, locate the reset button (hole) on the rear panel of the unit. With the router powered on, use a paperclip to hold the button down for 10 seconds. Release the button and the router will go through its reboot process. Wait about 30 seconds to access the router. The default IP address is **192.168.0.1**. When logging in, leave the password box empty.

3. Why can't I connect to certain sites or send and receive emails when connecting through my router?

If you are having a problem sending or receiving email, or connecting to secure sites such as eBay, banking sites, and Hotmail, we suggest lowering the MTU in increments of ten (Ex. 1492, 1482, 1472, etc).

To find the proper MTU Size, you'll have to do a special ping of the destination you're trying to go to. A destination could be another computer, or a URL.

- Click on **Start** and then click **Run**.
- Windows® 95, 98, and Me users type in **command** (Windows® NT, 2000, XP, Vista®, and 7 users type in **cmd**) and press **Enter** (or click **OK**).
- Once the window opens, you'll need to do a special ping. Use the following syntax:

ping [url] [-f] [-l] [MTU value]

Example: **ping yahoo.com -f -l 1472**

```
C:\>ping yahoo.com -f -l 1482
Pinging yahoo.com [66.94.234.13] with 1482 bytes of data:
Packet needs to be fragmented but DF set.
Packet needs to be fragmented but DF set.
Packet needs to be fragmented but DF set.
Packet needs to be fragmented but DF set.

Ping statistics for 66.94.234.13:
    Packets: Sent = 4, Received = 0, Lost = 4 (100% loss),
    Approximate round trip times in milli-seconds:
        Minimum = 0ms, Maximum = 0ms, Average = 0ms

C:\>ping yahoo.com -f -l 1472
Pinging yahoo.com [66.94.234.13] with 1472 bytes of data:
Reply from 66.94.234.13: bytes=1472 time=93ms TTL=52
Reply from 66.94.234.13: bytes=1472 time=109ms TTL=52
Reply from 66.94.234.13: bytes=1472 time=125ms TTL=52
Reply from 66.94.234.13: bytes=1472 time=203ms TTL=52

Ping statistics for 66.94.234.13:
    Packets: Sent = 4, Received = 4, Lost = 0 (0% loss),
    Approximate round trip times in milli-seconds:
        Minimum = 93ms, Maximum = 203ms, Average = 132ms

C:\>
```

You should start at 1472 and work your way down by 10 each time. Once you get a reply, go up by 2 until you get a fragmented packet. Take that value and add 28 to the value to account for the various TCP/IP headers. For example, let's say that 1452 was the proper value, the actual MTU size would be 1480, which is the optimum for the network we're working with ($1452+28=1480$).

Once you find your MTU, you can now configure your router with the proper MTU size.

To change the MTU rate on your router follow the steps below:

- Open your browser, enter the IP address of your router (192.168.0.1) and click **OK**.
- Enter your username (admin) and password (blank by default). Click **OK** to enter the web configuration page for the device.
- Click on **Setup** and then click **Manual Configure**.
- To change the MTU, enter the number in the MTU field and click **Save Settings** to save your settings.
- Test your email. If changing the MTU does not resolve the problem, continue changing the MTU in increments of ten.

Wireless Basics

D-Link wireless products are based on industry standards to provide easy-to-use and compatible high-speed wireless connectivity within your home, business, or public access wireless networks. Strictly adhering to the IEEE standard, the D-Link wireless family of products will allow you to securely access the data you want, when, and where you want it. You will be able to enjoy the freedom that wireless networking delivers.

A wireless local area network (WLAN) is a cellular computer network that transmits and receives data with radio signals instead of wires. Wireless LANs are used increasingly in both home and office environments, and public areas such as airports, coffee shops and universities. Innovative ways to utilize WLAN technology are helping people work, and communicate more efficiently. Increased mobility and the absence of cabling and other fixed infrastructure have proven to be beneficial for many users.

Wireless users can use the same applications they use on a wired network. Wireless adapter cards used on laptop and desktop systems support the same protocols as Ethernet adapter cards.

Under many circumstances, it may be desirable for mobile network devices to link to a conventional Ethernet LAN in order to use servers, printers or an Internet connection supplied through the wired LAN. A wireless router is a device used to provide this link.

What is Wireless?

Wireless or Wi-Fi technology is another way of connecting your computer to the network without using wires. Wi-Fi uses radio frequency to connect wirelessly so you have the freedom to connect computers anywhere in your home or office network.

Why D-Link Wireless?

D-Link is the worldwide leader and award winning designer, developer, and manufacturer of networking products. D-Link delivers the performance you need at a price you can afford. D-Link has all the products you need to build your network.

How does wireless work?

Wireless works similarly to how cordless phones work, through radio signals that transmit data from one point A to point B. But wireless technology has restrictions as to how you can access the network. You must be within the wireless network range area to be able to connect your computer. There are two different types of wireless networks: Wireless Local Area Network (WLAN), and Wireless Personal Area Network (WPAN).

Wireless Local Area Network (WLAN)

In a wireless local area network, a device called an Access Point (AP) connects computers to the network. The access point has a small antenna attached to it, which allows it to transmit data back and forth over radio signals. With an indoor access point the signal can travel up to 300 feet. With an outdoor access point the signal can reach out up to 30 miles to serve places like manufacturing plants, industrial locations, university and high school campuses, airports, golf courses, and many other outdoor venues.

Wireless Personal Area Network (WPAN)

Bluetooth is the industry standard wireless technology used for WPAN. Bluetooth devices in WPAN operate in a range up to 30 feet away.

Compared to WLAN the speed and wireless operation range are both less than WLAN, but in return it doesn't use nearly as much power. This makes it ideal for personal devices, such as mobile phones, PDAs, headphones, laptops, speakers, and other devices that operate on batteries.

Who uses wireless?

Wireless technology has become so popular in recent years that almost everyone is using it, whether it's for home, office, business, D-Link has a wireless solution for it.

Home Uses/Benefits

- Gives everyone at home broadband access
- Surf the web, check email, instant message, etc.
- Gets rid of the cables around the house
- Simple and easy to use

Small Office and Home Office Uses/Benefits

- Stay on top of everything at home as you would at office
- Remotely access your office network from home
- Share Internet connection and printer with multiple computers
- No need to dedicate office space

Where is wireless used?

Wireless technology is expanding everywhere, not just at home or office. People like the freedom of mobility and it's becoming so popular that more and more public facilities now provide wireless access to attract people. The wireless connection in public places is usually called "hotspots".

Using a D-Link USB adapter with your laptop, you can access the hotspot to connect to the Internet from remote locations like: airports, hotels, coffee shops, libraries, restaurants, and convention centers.

Wireless network is easy to setup, but if you're installing it for the first time it could be quite a task not knowing where to start. That's why we've put together a few setup steps and tips to help you through the process of setting up a wireless network.

Tips

Here are a few things to keep in mind, when you install a wireless network.

Centralize your router or access point

Make sure you place the router/access point in a centralized location within your network for the best performance. Try to place the router/access point as high as possible in the room, so the signal gets dispersed throughout your home. If you have a two-story home, you may need a repeater to boost the signal to extend the range.

Eliminate Interference

Place home appliances such as cordless telephones, microwaves, and televisions as far away as possible from the router/access point. This would significantly reduce any interference that the appliances might cause since they operate on same frequency.

Security

Don't let your next-door neighbors or intruders connect to your wireless network. Secure your wireless network by turning on the WPA or WEP security feature on the router. Refer to the product manual for detail information on how to set it up.

Wireless Modes

There are basically two modes of networking:

- **Infrastructure** – All wireless clients will connect to an access point or wireless router.
- **Ad-hoc** – Directly connecting to another computer for peer-to-peer communication using wireless network adapters on each computer, such as two or more DIR-879 wireless network USB adapters.

An Infrastructure network contains an access point or wireless router. All the wireless devices, or clients, will connect to the wireless router or access point.

An Ad-hoc network contains only clients, such as laptops with wireless USB adapters. All the adapters must be in Ad-hoc mode to communicate.

Networking Basics

Check your IP address

After you install your new D-Link adapter, by default, the TCP/IP settings should be set to obtain an IP address from a DHCP server (i.e. wireless router) automatically. To verify your IP address, please follow the steps below.

Click on **Start** > **Run**. In the run box type **cmd** and click **OK**. (Windows® 7/Vista® users type **cmd** in the **Start Search** box.)

At the prompt, type **ipconfig** and press **Enter**.

This will display the IP address, subnet mask, and the default gateway of your adapter.

If the address is 0.0.0.0, check your adapter installation, security settings, and the settings on your router. Some firewall software programs may block a DHCP request on newly installed adapters.

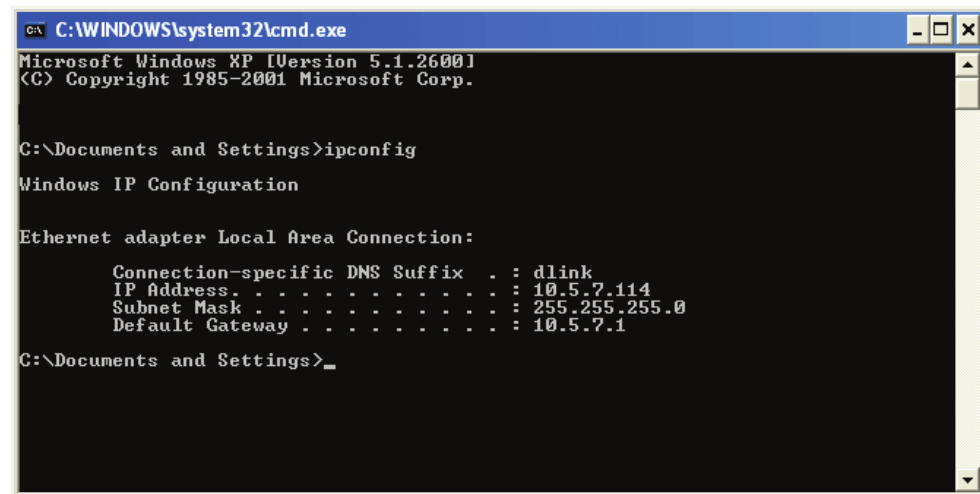

```
C:\WINDOWS\system32\cmd.exe
Microsoft Windows XP [Version 5.1.2600]
(C) Copyright 1985-2001 Microsoft Corp.

C:\Documents and Settings>ipconfig

Windows IP Configuration

Ethernet adapter Local Area Connection:

    Connection-specific DNS Suffix  . : dlink
    IP Address . . . . . : 10.5.7.114
    Subnet Mask . . . . . : 255.255.255.0
    Default Gateway . . . . . : 10.5.7.1

C:\Documents and Settings>_
```

Statically Assign an IP address

If you are not using a DHCP capable gateway/router, or you need to assign a static IP address, please follow the steps below:

Step 1

- Windows® 7 - Click on **Start > Control Panel > Network and Internet > Network and Sharing Center.**
- Windows Vista® - Click on **Start > Control Panel > Network and Internet > Network and Sharing Center > Manage Network Connections.**
- Windows® XP - Click on **Start > Control Panel > Network Connections.**
- Windows® 2000 - From the desktop, right-click **My Network Places > Properties.**

Step 2

Right-click on the **Local Area Connection** which represents your network adapter and select **Properties.**

Step 3

Highlight **Internet Protocol (TCP/IP)** and click **Properties.**

Step 4

Click **Use the following IP address** and enter an IP address that is on the same subnet as your network or the LAN IP address on your router.

Example: If the router's LAN IP address is 192.168.0.1, make your IP address 192.168.0.X where X is a number between 2 and 99. Make sure that the number you choose is not in use on the network. Set the Default Gateway the same as the LAN IP address of your router (I.E. 192.168.0.1).

Set Primary DNS the same as the LAN IP address of your router (192.168.0.1). The Secondary DNS is not needed or you may enter a DNS server from your ISP.

Step 5

Click **OK** twice to save your settings.

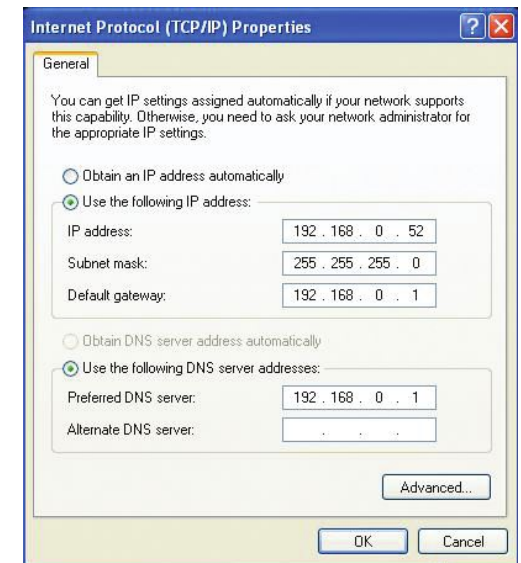

Wireless Security

This section will show you the different levels of security you can use to protect your data from intruders. The DIR-879 offers the following types of security:

- WPA2 (Wi-Fi Protected Access 2)
- WPA (Wi-Fi Protected Access)
- WPA2-PSK (Pre-Shared Key)
- WPA-PSK (Pre-Shared Key)

What is WPA?

WPA (Wi-Fi Protected Access), is a Wi-Fi standard that was designed to improve the security features of WEP (Wired Equivalent Privacy).

The 2 major improvements over WEP:

- Improved data encryption through the Temporal Key Integrity Protocol (TKIP). TKIP scrambles the keys using a hashing algorithm and by adding an integrity-checking feature, ensures that the keys haven't been tampered with. WPA2 is based on 802.11i and uses Advanced Encryption Standard (AES) instead of TKIP.
- User authentication, which is generally missing in WEP, through the extensible authentication protocol (EAP). WEP regulates access to a wireless network based on a computer's hardware-specific MAC address, which is relatively simple to be sniffed out and stolen. EAP is built on a more secure public-key encryption system to ensure that only authorized network users can access the network.

WPA-PSK/WPA2-PSK uses a passphrase or key to authenticate your wireless connection. The key is an alpha-numeric password between 8 and 63 characters long. The password can include symbols (!?*&_) and spaces. This key must be the exact same key entered on your wireless router or access point.

WPA/WPA2 incorporates user authentication through the Extensible Authentication Protocol (EAP). EAP is built on a more secure public key encryption system to ensure that only authorized network users can access the network.

Technical Specifications

Hardware Specifications

- LAN Interface: Four 10/100/1000 Mbps LAN ports
- WAN Interface: One 10/100/1000 Mbps Internet port
- Wireless Interface (2.4 GHz): IEEE 802.11n/g/b
- Wireless Interface (5 GHz): IEEE 802.11 ac/n/a

Operating Voltage

- Input: 100~240 V AC, 50~60 Hz
- Output: 12 V DC, 2 A

Temperature

- Operating: 0 ~ 40 °C (32 ~ 104 °F)
- Non-Operating: -20 ~ 65 °C (-20 ~ 149 °F)

Humidity

- Operating: 10% - 90% non-condensing
- Non-Operating: 5% - 95% non-condensing

Wireless Frequency Range

- IEEE 802.11a: 5150 MHz~5250 MHz, 5725 MHz~5850 MHz
- IEEE 802.11b: 2400 MHz~2483.5 MHz
- IEEE 802.11g: 2400 MHz~2483.5 MHz
- IEEE 802.11n: 2400 MHz~2483.5 MHz, 5150 MHz~5250 MHz, 5725 MHz~5850 MHz
- IEEE 802.11ac: 5150 MHz~5250 MHz, 5725 MHz~5850 MHz

Wireless Bandwidth Rate

- IEEE 802.11a: 54, 48, 36, 24, 18, 12, 9, and 6 Mbps
- IEEE 802.11b: 11, 5.5, 2, and 1 Mbps

- IEEE 802.11g: 54, 48, 36, 24, 18, 12, 9, and 6 Mbps
- IEEE 802.11n: 6.5 to 600 Mbps
- IEEE 802.11ac: 6.5 to 1300 Mbps

Antenna Type

- Four external antennas

Wireless Security

- 64/128bit WEP, WPA/WPA2-Personal, WPS-PBC

EMI/EMC Certification

- CE
- FCC
- IC
- BSMI
- CCC

RF Certification

- CE
- FCC
- IC
- NCC

Safety Certification

- CSA
- CCC
- BSMI

Dimensions & Weight

- 219.67 x 199.45 x 73.55 mm (8.65 x 7.85 x 2.90 inches)
- 750 g (26.5 oz)

Regulatory Statements

Federal Communication Commission Interference Statement

This equipment has been tested and found to comply with the limits for a Class B digital device, pursuant to Part 15 of the FCC Rules. These limits are designed to provide reasonable protection against harmful interference in a residential installation. This equipment generates, uses and can radiate radio frequency energy and, if not installed and used in accordance with the instructions, may cause harmful interference to radio communications. However, there is no guarantee that interference will not occur in a particular installation. If this equipment does cause harmful interference to radio or television reception, which can be determined by turning the equipment off and on, the user is encouraged to try to correct the interference by one of the following measures:

- Reorient or relocate the receiving antenna.
- Increase the separation between the equipment and receiver.
- Connect the equipment into an outlet on a circuit different from that to which the receiver is connected.
- Consult the dealer or an experienced radio/TV technician for help.

Non-modifications Statement:

Any changes or modifications not expressly approved by the party responsible for compliance could void the user's authority to operate this equipment.

Caution:

This device complies with Part 15 of the FCC Rules. Operation is subject to the following two conditions:

- (1) This device may not cause harmful interference, and
- (2) this device must accept any interference received, including interference that may cause undesired operation.

This device and its antenna(s) must not be co-located or operating in conjunction with any other antenna or transmitter except in accordance with FCC multi-transmitter product procedures. For product available in the USA/Canada market, only channel 1~11 can be operated. Selection of other channels is not possible.

Note

The country code selection is for non-USA models only and is not available to all USA models. Per FCC regulations, all WiFi product marketed in the USA must be fixed to USA operational channels only.

RF Frequency Requirements

This device is for indoor use only when using all channels in the 5.150 to 5.250 GHz frequency range. High power radars are allocated as primary users of the 5.150 GHz - 5.250 GHz bands. These radar stations can cause interference with and/or damage this device.

It is restricted to indoor environments only.

IMPORTANT NOTICE:

FCC Radiation Exposure Statement

This equipment complies with FCC radiation exposure limits set forth for an uncontrolled environment. This equipment should be installed and operated with minimum distance 26 cm between the radiator and your body.

Industry Canada Statement:

This device complies with Industry Canada licence-exempt RSS standard(s). Operation is subject to the following two conditions:

- (1) this device may not cause interference, and
- (2) this device must accept any interference, including interference that may cause undesired operation of the device.

Le présent appareil est conforme aux CNR d'Industrie Canada applicables aux appareils radio exempts de licence. L'exploitation est autorisée aux deux conditions suivantes:

- (1) l'appareil ne doit pas produire de brouillage, et
- (2) l'utilisateur de l'appareil doit accepter tout brouillage radioélectrique subi, même si le brouillage est susceptible d'en compromettre le fonctionnement.

(i) the device for operation in the band 5150-5250 MHz is only for indoor use to reduce the potential for harmful interference to co-channel mobile satellite systems;

(i) les dispositifs fonctionnant dans la bande 5150-5250 MHz sont réservés uniquement pour une utilisation à l'intérieur afin de réduire les risques de brouillage préjudiciable aux systèmes de satellites mobiles utilisant les mêmes canaux;

Radiation Exposure Statement

This equipment complies with IC radiation exposure limits set forth for an uncontrolled environment. This equipment should be installed and operated with minimum distance 26 cm between the radiator and your body.

Déclaration d'exposition aux radiations

Cet équipement est conforme aux limites d'exposition aux rayonnements IC établies pour un environnement non contrôlé. Cet équipement doit être installé et utilisé avec un minimum de 26 cm de distance entre la source de rayonnement et votre corps.

This radio transmitter DIR-879A1 has been approved by Industry Canada to operate with the antenna types listed below with the maximum permissible gain and required antenna impedance for each antenna type indicated. Antenna types not included in this list, having a gain greater than the maximum gain indicated for that type, are strictly prohibited for use with this device.

Le présent émetteur radio DIR-879A1 a été approuvé par Industrie Canada pour fonctionner avec les types d'antenne énumérés ci-dessous et ayant un gain admissible maximal et l'impédance requise pour chaque type d'antenne. Les types d'antenne non inclus dans cette liste, ou dont le gain est supérieur au gain maximal indiqué, sont strictement interdits pour l'exploitation de l'émetteur.

Table for Filed Antenna

Ant.	Brand	Model Name	Antenna Type	Connector	2.4 G Gain (dBi)	5 G Gain (dBi)
1	Nienyi	NYS1751	PCB Antenna	MHF-I Plug	3 dBi	3 dBi
2	Nienyi	NYS1752	PCB Antenna	MHF-I Plug	3 dBi	3 dBi
3	Nienyi	NYS1753	PCB Antenna	MHF-I Plug	3 dBi	3 dBi
4	Nienyi	NYS1754	PCB Antenna	MHF-I Plug	3 dBi	3 dBi

NCC 警語：

以下警語適用台灣地區

經型式認證合格之低功率射頻電機，非經許可，公司、商號或使用者均不得擅自變更頻率、加大功率或變更原設計之特性及功能。低功率射頻電機之使用不得影響飛航安全及干擾合法通信；經發現有干擾現象時，應立即停用，並改善至無干擾時方得繼續使用。前項合法通信，指依電信法規定作業之無線電通信。低功率射頻電機須忍受合法通信或工業、科學及醫療用電波輻射性電機設備之干擾。

本模組於取得認證後將依規定於模組本體標示審驗合格標籤系統廠商應於平台上標示「本產品內含射頻模組：

(((CCAF16LP0260T0)」字樣

無線傳輸設備 (UNII)

在 5.25-5.35 兆赫頻帶內操作之無線資訊傳輸設備，限於室內使用。無線資訊傳輸設備忍受合法通信之干擾且不得干擾合法通信；如造成干擾，應立即停用，俟無干擾之虞，始得繼續使用。無線資訊傳輸設備的製造廠商應確保頻率穩定性，如依製造廠商使用手冊上所述正常操作，發射的信號應維持於操作頻帶中。

電磁波曝露量MPE標準值(MPE) 1 mW/cm²，送測產品實值為 1 mW/cm²

European Union:

This device complies with the essential requirements of the R&TTE Directive 1999/5/EC. For more information, please refer to the Declaration of Conformity.

Notice of Wireless Radio LAN Usage in The European Community:

- At the time of writing this addendum, some countries such as Italy, Greece, Portugal, and Spain have not allowed operation of radio devices in the 5 GHz bands, although operation of 2.4 GHz radio devices is allowed. Please check with your local authority to confirm.
- This device is restricted to indoor use when operated in the European Community using channels in the 5.15-5.35 GHz band to reduce the potential for interference.
- This device is a 2.4 GHz wideband transmission system (transceiver), intended for use in all EU member states and EFTA countries, except in France where restrictive use applies. This device may not be used for setting up outdoor radio links in France and in some areas the RF output power may be limited to 10 mW EIRP in the frequency range of 2454 –2483.5 MHz. For detailed information the end-user should contact the national spectrum authority in France.

This equipment may be operated in AL, AD, BE, BG, DK, DE, FI, FR, GR, GW, IS, IT, HR, LI, LU, MT, MK, MD, MC, NL, NO, AT, OL, PT, RO, SM, SE, RS, SK, ES, CI, HU, CY

Usage Notes:

- To remain in conformance with European National spectrum usage regulations, frequency and channel limitations will be applied on the products according to the country where the equipment will be deployed.
- This device is restricted from functioning in Ad-hoc mode while operating in 5 GHz. Ad-hoc mode is direct peer-to-peer communication between two client devices without an Access Point.
- Access points will support DFS (Dynamic Frequency Selection) and TPC (Transmit Power Control) functionality as required when operating in 5 GHz within the EU.

2.4 GHz Wireless Frequency and Channel Operation in EEC Countries:

Region	Frequency Band	Max output power (EIRP)
Metropolitan	2400 - 2454 MHz	100 mW
Guadeloupe, Martinique, St Pierre et Miquelon, Mayotte	2454 - 2483.5 MHz	100 mW indoor, 10 mW outdoor
Reunion et Guyane	2400 - 2483.5 MHz	100 mW
Rest of EU community	2420 - 2483.5 MHz	100 mW

R&TTE 1999/5/EC			
WLAN 2.4 - 2.4835 GHz			
IEEE 802.11b/g/n			
Spectrum Regulation	MHz, Europa (ETSI)	max. EIRP Innenbereich	max. EIRP Außenbereich
Europa	2400 - 2483.5 MHz	100 mW	100 mW
Frankreich	2400 - 2454 MHz	100 mW	100 mW
	2454 - 2483.5 MHz	100 mW	10 mW

5 GHz Wireless Frequency and Channel Operation in EEC Countries:	
Allowable 802.11a Frequencies and Channels	Countries
5.15-5.25 GHz (Channels 36, 40, 44, 48)	Liechtenstein
5.15-5.25 GHz & 5.725-5.875 GHz (Channels 36, 40, 44, 48, 149, 153, 157, 161, 165, 169)	Austria
5.15-5.35 GHz (Channels 36, 40, 44, 48, 52, 56, 60, 64)	France
5.15-5.35 & 5.47-5.725 GHz (Channels 36, 40, 44, 48, 52, 56, 60, 64, 100, 104, 108, 112, 116, 120, 124, 128, 132, 136, 140)	Denmark, Germany, Iceland, Finland, Netherlands, Norway, Poland, Sweden, Slovenia, Luxembourg, U.K., Ireland, Slovak, Switzerland, Hungary, Italy
5.15-5.35 GHz & 5.725-5.875 GHz (Channels 36, 40, 44, 48, 52, 56, 60, 64, 149, 153, 157, 161, 165, 169)	Czech Republic

European Community Declaration of Conformity:

Česky [Czech]	D-Link tímto prohlašuje, že tento DIR-879 je ve shodě se základními požadavky a dalšími příslušnými ustanoveními směrnice 1999/5/ES.
Dansk [Danish]	Undertegnede D-Link erklærer herved, at følgende udstyr DIR-879 overholder de væsentlige krav og øvrige relevante krav i direktiv 1999/5/EF.
Deutsch [German]	Hiermit erkläre D-Link, dass sich das Gerät DIR-879 in Übereinstimmung mit den grundlegenden Anforderungen und den übrigen einschlägigen Bestimmungen der Richtlinie 1999/5/EG befindet.
Eesti [Estonian]	Käesolevaga kinnitab D-Link seadme DIR-879 vastavust direktiivi 1999/5/EÜ põhinõuetele ja nimetatud direktiivist tulenevatele teistele asjakohastele sätetele.
English	D-Link hereby, declares that this DIR-879 is in compliance with the essential requirements and other relevant provisions of Directive 1999/5/EC.
Español [Spanish]	Por medio de la presente D-Link declara que el DIR-879 cumple con los requisitos esenciales y cualesquiera otras disposiciones aplicables o exigibles de la Directiva 1999/5/CE.
Ελληνική [Greek]	ΜΕ ΤΗΝ ΠΑΡΟΥΣΑ D-Link ΔΗΛΩΝΕΙ ΟΤΙ DIR-879 ΣΥΜΜΟΡΦΩΝΕΤΑΙ ΠΡΟΣ ΤΙΣ ΟΥΣΙΩΔΕΙΣ ΑΠΑΙΤΗΣΕΙΣ ΚΑΙ ΤΙΣ ΛΟΙΠΕΣ ΣΧΕΤΙΚΕΣ ΔΙΑΤΑΞΕΙΣ ΤΗΣ ΟΔΗΓΙΑΣ 1999/5/ΕΚ.
Français [French]	Par la présente D-Link déclare que l'appareil DIR-879 est conforme aux exigences essentielles et aux autres dispositions pertinentes de la directive 1999/5/CE.
Italiano [Italian]	Con la presente D-Link dichiara che questo DIR-879 è conforme ai requisiti essenziali ed alle altre disposizioni pertinenti stabilite dalla direttiva 1999/5/CE.
Latviski [Latvian]	Ar šo D-Link deklarē, ka DIR-879 atbilst Direktīvas 1999/5/EK būtiskajām prasībām un citiem ar to saistītajiem noteikumiem.
Lietuvių [Lithuanian]	Šiuo D-Link deklaruoja, kad šis DIR-879 atitinka esminius reikalavimus ir kitas 1999/5/EB Direktyvos nuostatas.
Nederlands [Dutch]	Hierbij verklaart D-Link dat het toestel DIR-879 in overeenstemming is met de essentiële eisen en de andere relevante bepalingen van richtlijn 1999/5/EG.
Malti [Maltese]	Hawnhekk, D-Link, jiddikjara li dan DIR-879 jikkonforma mal-ħtiġijiet essenzjali u ma provvedimenti oħrajn rilevanti li hemm fid-Dirrettiva 1999/5/EC.
Magyar [Hungarian]	Alulírott, D-Link nyilatkozom, hogy a DIR-879 megfelel a vonatkozó alapvető követelményeknek és az 1999/5/EC irányelv egyéb előírásainak.

Polski [Polish]	Niniejszym D-Link oświadcza, że DIR-879 jest zgodny z zasadniczymi wymogami oraz pozostałymi stosownymi postanowieniami Dyrektywy 1999/5/EC.
Português [Portuguese]	D-Link declara que este DIR-879 está conforme com os requisitos essenciais e outras disposições da Directiva 1999/5/CE.
Slovensko [Slovenian]	D-Link izjavlja, da je ta DIR-879 v skladu z bistvenimi zahtevami in ostalimi relevantnimi določili direktive 1999/5/ES.
Slovensky [Slovak]	D-Link týmto vyhlasuje, že DIR-879 spĺňa základné požiadavky a všetky príslušné ustanovenia Smernice 1999/5/ES.
Suomi [Finnish]	D-Link vakuuttaa täten että DIR-879 tyyppinen laite on direktiivin 1999/5/EY oleellisten vaatimusten ja sitä koskevien direktiivin muiden ehtojen mukainen.

Warning Statement:

The power outlet should be near the device and easily accessible.



Disposing of and Recycling Your Product

ENGLISH

EN



This symbol on the product or packaging means that according to local laws and regulations this product should be not be disposed of in household waste but sent for recycling. Please take it to a collection point designated by your local authorities once it has reached the end of its life, some will accept products for free. By recycling the product and its packaging in this manner you help to conserve the environment and protect human health.

D-Link and the Environment

At D-Link, we understand and are committed to reducing any impact our operations and products may have on the environment. To minimise this impact D-Link designs and builds its products to be as environmentally friendly as possible, by using recyclable, low toxic materials in both products and packaging.

D-Link recommends that you always switch off or unplug your D-Link products when they are not in use. By doing so you will help to save energy and reduce CO2 emissions.

To learn more about our environmentally responsible products and packaging please visit www.dlinkgreen.com.

DEUTSCH

DE



Dieses Symbol auf dem Produkt oder der Verpackung weist darauf hin, dass dieses Produkt gemäß bestehender örtlicher Gesetze und Vorschriften nicht über den normalen Hausmüll entsorgt werden sollte, sondern einer Wiederverwertung zuzuführen ist. Bringen Sie es bitte zu einer von Ihrer Kommunalbehörde entsprechend amtlich ausgewiesenen Sammelstelle, sobald das Produkt das Ende seiner Nutzungsdauer erreicht hat. Für die Annahme solcher Produkte erheben einige dieser Stellen keine Gebühren. Durch ein auf diese Weise durchgeführtes Recycling des Produkts und seiner Verpackung helfen Sie, die Umwelt zu schonen und die menschliche Gesundheit zu schützen.

D-Link und die Umwelt

D-Link ist sich den möglichen Auswirkungen seiner Geschäftstätigkeiten und seiner Produkte auf die Umwelt bewusst und fühlt sich verpflichtet, diese entsprechend zu mindern. Zu diesem Zweck entwickelt und stellt D-Link seine Produkte mit dem Ziel größtmöglicher Umweltfreundlichkeit her und verwendet wiederverwertbare, schadstoffarme Materialien bei Produktherstellung und Verpackung.

D-Link empfiehlt, Ihre Produkte von D-Link, wenn nicht in Gebrauch, immer auszuschalten oder vom Netz zu nehmen. Auf diese Weise helfen Sie, Energie zu sparen und CO2-Emissionen zu reduzieren.

Wenn Sie mehr über unsere umweltgerechten Produkte und Verpackungen wissen möchten, finden Sie entsprechende Informationen im Internet unter www.dlinkgreen.com.

FRANÇAIS**FR**

Ce symbole apposé sur le produit ou son emballage signifie que, conformément aux lois et réglementations locales, ce produit ne doit pas être éliminé avec les déchets domestiques mais recyclé. Veuillez le rapporter à un point de collecte prévu à cet effet par les autorités locales; certains accepteront vos produits gratuitement. En recyclant le produit et son emballage de cette manière, vous aidez à préserver l'environnement et à protéger la santé de l'homme.

D-Link et l'environnement

Chez D-Link, nous sommes conscients de l'impact de nos opérations et produits sur l'environnement et nous engageons à le réduire. Pour limiter cet impact, D-Link conçoit et fabrique ses produits de manière aussi écologique que possible, en utilisant des matériaux recyclables et faiblement toxiques, tant dans ses produits que ses emballages.

D-Link recommande de toujours éteindre ou débrancher vos produits D-Link lorsque vous ne les utilisez pas. Vous réaliserez ainsi des économies d'énergie et réduirez vos émissions de CO₂.

Pour en savoir plus sur les produits et emballages respectueux de l'environnement, veuillez consulter le www.dlinkgreen.com.

ESPAÑOL**ES**

Este símbolo en el producto o el embalaje significa que, de acuerdo con la legislación y la normativa local, este producto no se debe desechar en la basura doméstica sino que se debe reciclar. Llévelo a un punto de recogida designado por las autoridades locales una vez que ha llegado al fin de su vida útil; algunos de ellos aceptan recogerlos de forma gratuita. Al reciclar el producto y su embalaje de esta forma, contribuye a preservar el medio ambiente y a proteger la salud de los seres humanos.

D-Link y el medio ambiente

En D-Link, comprendemos y estamos comprometidos con la reducción del impacto que puedan tener nuestras actividades y nuestros productos en el medio ambiente. Para reducir este impacto, D-Link diseña y fabrica sus productos para que sean lo más ecológicos posible, utilizando materiales reciclables y de baja toxicidad tanto en los productos como en el embalaje.

D-Link recomienda apagar o desenchufar los productos D-Link cuando no se estén utilizando. Al hacerlo, contribuirá a ahorrar energía y a reducir las emisiones de CO₂.

Para obtener más información acerca de nuestros productos y embalajes ecológicos, visite el sitio www.dlinkgreen.com.

ITALIANO**IT**

La presenza di questo simbolo sul prodotto o sulla confezione del prodotto indica che, in conformità alle leggi e alle normative locali, questo prodotto non deve essere smaltito nei rifiuti domestici, ma avviato al riciclo. Una volta terminato il ciclo di vita utile, portare il prodotto presso un punto di raccolta indicato dalle autorità locali. Alcuni questi punti di raccolta accettano gratuitamente i prodotti da riciclare. Scegliendo di riciclare il prodotto e il relativo imballaggio, si contribuirà a preservare l'ambiente e a salvaguardare la salute umana.

D-Link e l'ambiente

D-Link cerca da sempre di ridurre l'impatto ambientale dei propri stabilimenti e dei propri prodotti. Allo scopo di ridurre al minimo tale impatto, D-Link progetta e realizza i propri prodotti in modo che rispettino il più possibile l'ambiente, utilizzando materiali riciclabili a basso tasso di tossicità sia per i prodotti che per gli imballaggi.

D-Link raccomanda di spegnere sempre i prodotti D-Link o di scollegarne la spina quando non vengono utilizzati. In questo modo si contribuirà a risparmiare energia e a ridurre le emissioni di anidride carbonica.

Per ulteriori informazioni sui prodotti e sugli imballaggi D-Link a ridotto impatto ambientale, visitate il sito all'indirizzo www.dlinkgreen.com.

NEDERLANDS**NL**

Dit symbool op het product of de verpakking betekent dat dit product volgens de plaatselijke wetgeving niet mag worden weggegooid met het huishoudelijk afval, maar voor recyclage moeten worden ingeleverd. Zodra het product het einde van de levensduur heeft bereikt, dient u het naar een inzamelpunt te brengen dat hiertoe werd aangeduid door uw plaatselijke autoriteiten, sommige autoriteiten accepteren producten zonder dat u hiervoor dient te betalen. Door het product en de verpakking op deze manier te recyclen helpt u het milieu en de gezondheid van de mens te beschermen.

D-Link en het milieu

Bij D-Link spannen we ons in om de impact van onze handelingen en producten op het milieu te beperken. Om deze impact te beperken, ontwerpt en bouwt D-Link zijn producten zo milieuvriendelijk mogelijk, door het gebruik van recycleerbare producten met lage toxiciteit in product en verpakking.

D-Link raadt aan om steeds uw D-Link producten uit te schakelen of uit de stekker te halen wanneer u ze niet gebruikt. Door dit te doen bespaart u energie en beperkt u de CO₂-emissies.

Breng een bezoek aan www.dlinkgreen.com voor meer informatie over onze milieuverantwoorde producten en verpakkingen.

POLSKI**PL**

Ten symbol umieszczony na produkcie lub opakowaniu oznacza, że zgodnie z miejscowym prawem i lokalnymi przepisami niniejszego produktu nie wolno wyrzucać jak odpady czy śmieci z gospodarstwa domowego, lecz należy go poddać procesowi recyklingu. Po zakończeniu użytkowania produktu, niektóre odpowiednie do tego celu podmioty przyjmą takie produkty nieodpłatnie, dlatego prosimy dostarczyć go do punktu zbiórki wskazanego przez lokalne władze. Poprzez proces recyklingu i dzięki takiemu postępowaniu z produktem oraz jego opakowaniem, pomogą Państwo chronić środowisko naturalne i dbać o ludzkie zdrowie.

D-Link i środowisko

D-Link podchodzimy w sposób świadomy do ochrony otoczenia oraz jesteśmy zaangażowani w zmniejszanie wpływu naszych działań i produktów na środowisko naturalne. W celu zminimalizowania takiego wpływu firma D-Link konstruuje i wytwarza swoje produkty w taki sposób, aby były one jak najbardziej przyjazne środowisku, stosując do tych celów materiały nadające się do powtórnego wykorzystania, charakteryzujące się małą toksycznością zarówno w przypadku samych produktów jak i opakowań.

Firma D-Link zaleca, aby Państwo zawsze prawidłowo wyłączali z użytku swoje produkty D-Link, gdy nie są one wykorzystywane. Postępując w ten sposób pozwalają Państwo oszczędzać energię i zmniejszać emisje CO₂.

Aby dowiedzieć się więcej na temat produktów i opakowań mających wpływ na środowisko prosimy zapoznać się ze stroną Internetową www.dlinkgreen.com.

ČESKY**CZ**

Tento symbol na výrobku nebo jeho obalu znamená, že podle místně platných předpisů se výrobek nesmí vyhazovat do komunálního odpadu, ale odeslat k recyklaci. Až výrobek doslouží, odneste jej prosím na sběrné místo určené místními úřady k tomuto účelu. Někteřá sběrná místa přijímají výrobky zdarma. Recyklací výrobku i obalu pomáháte chránit životní prostředí i lidské zdraví.

D-Link a životní prostředí

Ve společnosti D-Link jsme si vědomi vlivu našich provozů a výrobků na životní prostředí a snažíme se o minimalizaci těchto vlivů. Proto své výrobky navrhujeme a vyrábíme tak, aby byly co nejekologičtější, a ve výrobcích i obalech používáme recyklovatelné a nízkotoxické materiály.

Společnost D-Link doporučuje, abyste své výrobky značky D-Link vypnuli nebo vytáhli ze zásuvky vždy, když je nepoužíváte. Pomůžete tak šetřit energii a snížit emise CO₂.

Více informací o našich ekologických výrobcích a obalech najdete na adrese www.dlinkgreen.com.

MAGYAR**HU**

Ez a szimbólum a terméken vagy a csomagoláson azt jelenti, hogy a helyi törvényeknek és szabályoknak megfelelően ez a termék nem semmisíthető meg a háztartási hulladékkal együtt, hanem újrahasznosításra kell küldeni. Kérjük, hogy a termék élettartamának elteltét követően vigye azt a helyi hatóság által kijelölt gyűjtőhelyre. A termékek egyes helyeken ingyen elhelyezhetők. A termék és a csomagolás újrahasznosításával segíti védeni a környezetet és az emberek egészségét.

A D-Link és a környezet

A D-Linknél megértjük és elköteleztük magunkat a műveleteink és termékeink környezetre gyakorolt hatásainak csökkentésére. Az ezen hatás csökkentése érdekében a D-Link a lehető leginkább környezetbarát termékeket tervez és gyárt azáltal, hogy újrahasznosítható, alacsony károsanyag-tartalmú termékeket gyárt és csomagolásokat alkalmaz.

A D-Link azt javasolja, hogy mindig kapcsolja ki vagy húzza ki a D-Link termékeket a tápforrásból, ha nem használja azokat. Ezzel segít az energia megtakarításában és a széndioxid kibocsátásának csökkentésében.

Környezetbarát termékeinkről és csomagolásainkról további információkat a www.dlinkgreen.com weboldalon tudhat meg.

NORSK**NO**

Dette symbolet på produktet eller forpakningen betyr at dette produktet ifølge lokale lover og forskrifter ikke skal kastes sammen med husholdningsavfall, men leveres inn til gjenvinning. Vennligst ta det til et innsamlingssted anvist av lokale myndigheter når det er kommet til slutten av levetiden. Noen steder aksepteres produkter uten avgift. Ved på denne måten å gjenvinne produktet og forpakningen hjelper du å verne miljøet og beskytte folks helse.

D-Link og miljøet

Hos D-Link forstår vi oss på og er forpliktet til å minske innvirkningen som vår drift og våre produkter kan ha på miljøet. For å minimalisere denne innvirkningen designer og lager D-Link produkter som er så miljøvennlig som mulig, ved å bruke resirkulerbare, lav-toksiske materialer både i produktene og forpakningen.

D-Link anbefaler at du alltid slår av eller frakobler D-Link-produkter når de ikke er i bruk. Ved å gjøre dette hjelper du å spare energi og å redusere CO₂-utslipp.

For mer informasjon angående våre miljøansvarlige produkter og forpakninger kan du gå til www.dlinkgreen.com.

DANSK**DK**

Dette symbol på produktet eller emballagen betyder, at dette produkt i henhold til lokale love og regler ikke må bortskaffes som husholdningsaffald, mens skal sendes til genbrug. Indlever produktet til et indsamlingssted som angivet af de lokale myndigheder, når det er nået til slutningen af dets levetid. I nogle tilfælde vil produktet blive modtaget gratis. Ved at indlevere produktet og dets emballage til genbrug på denne måde bidrager du til at beskytte miljøet og den menneskelige sundhed.

D-Link og miljøet

Hos D-Link forstår vi og bestræber os på at reducere enhver indvirkning, som vores aktiviteter og produkter kan have på miljøet. For at minimere denne indvirkning designer og producerer D-Link sine produkter, så de er så miljøvenlige som muligt, ved at bruge genanvendelige materialer med lavt giftighedsniveau i både produkter og emballage.

D-Link anbefaler, at du altid slukker eller frakobler dine D-Link-produkter, når de ikke er i brug. Ved at gøre det bidrager du til at spare energi og reducere CO₂-udledningerne.

Du kan finde flere oplysninger om vores miljømæssigt ansvarlige produkter og emballage på www.dlinkgreen.com.

SUOMI**FI**

Tämä symboli tuotteen pakkauksessa tarkoittaa, että paikallisten lakien ja säännösten mukaisesti tätä tuotetta ei pidä hävittää yleisen kotitalousjätteen seassa vaan se tulee toimittaa kierrätettäväksi. Kun tuote on elinkaarensa päässä, toimita se lähimpään viranomaisten hyväksymään kierrätyspisteeseen. Kierrättämällä käytetyn tuotteen ja sen pakkauksen autat tukemaan sekä ympäristön että ihmisten terveyttä ja hyvinvointia.

D-Link ja ympäristö

D-Link ymmärtää ympäristönsuojelun tärkeyden ja on sitoutunut vähentämään tuotteistaan ja niiden valmistuksesta ympäristölle mahdollisesti aiheutuvia haittavaikutuksia. Nämä negatiiviset vaikutukset minimoidakseen D-Link suunnittelee ja valmistaa tuotteensa mahdollisimman ympäristöystävällisiksi käyttämällä kierrätettäviä, alhaisia pitoisuuksia haitallisia aineita sisältäviä materiaaleja sekä tuotteissaan että niiden pakkauksissa.

Suosittellemme, että irrotat D-Link-tuotteesi virtalähteestä tai sammutat ne aina, kun ne eivät ole käytössä. Toimimalla näin autat säästämään energiaa ja vähentämään hiilidioksiidipäästöjä.

Lue lisää ympäristöystävällisistä D-Link-tuotteista ja pakkauksistamme osoitteesta www.dlinkgreen.com.

SVENSKA**SE**

Den här symbolen på produkten eller förpackningen betyder att produkten enligt lokala lagar och föreskrifter inte skall kastas i hushållssoporna utan i stället återvinnas. Ta den vid slutet av dess livslängd till en av din lokala myndighet utsedd uppsamlingsplats, vissa accepterar produkter utan kostnad. Genom att på detta sätt återvinna produkten och förpackningen hjälper du till att bevara miljön och skydda människors hälsa.

D-Link och miljön

På D-Link förstår vi och är fast beslutna att minska den påverkan våra verksamheter och produkter kan ha på miljön. För att minska denna påverkan utformar och bygger D-Link sina produkter för att de ska vara så miljövänliga som möjligt, genom att använda återvinningsbara material med låg gifthalt i både produkter och förpackningar.

D-Link rekommenderar att du alltid stänger av eller kopplar ur dina D-Link produkter när du inte använder dem. Genom att göra detta hjälper du till att spara energi och minska utsläpp av koldioxid.

För mer information om våra miljöansvariga produkter och förpackningar www.dlinkgreen.com.

PORTUGUÊS**PT**

Este símbolo no produto ou embalagem significa que, de acordo com as leis e regulamentações locais, este produto não deverá ser eliminado juntamente com o lixo doméstico mas enviado para a reciclagem. Transporte-o para um ponto de recolha designado pelas suas autoridades locais quando este tiver atingido o fim da sua vida útil, alguns destes pontos aceitam produtos gratuitamente. Ao reciclar o produto e respectiva embalagem desta forma, ajuda a preservar o ambiente e protege a saúde humana.

A D-Link e o ambiente

Na D-Link compreendemos e comprometemo-nos com a redução do impacto que as nossas operações e produtos possam ter no ambiente. Para minimizar este impacto a D-Link concebe e constrói os seus produtos para que estes sejam o mais inofensivos para o ambiente possível, utilizando materiais recicláveis e não tóxicos tanto nos produtos como nas embalagens.

A D-Link recomenda que desligue os seus produtos D-Link quando estes não se encontrarem em utilização. Com esta acção ajudará a poupar energia e reduzir as emissões de CO₂.

Para saber mais sobre os nossos produtos e embalagens responsáveis a nível ambiental visite www.dlinkgreen.com.