

DPH-400G/DPH-400GE  
VERSION 1.00

# USER MANUAL



**D-Link**<sup>®</sup>

**VOIP**



## Safety Notices

Please read the following safety notices before installing or using this phone. They are crucial for the safe and reliable operation of the device.

- Please use the external power supply that is included in the package. Other power supplies may cause damage to the phone, affect the behavior or induce noise.
- Before using the external power supply in the package, please check with home power voltage. Inaccurate power voltage may cause fire and damage.
- Please do not damage the power cord. If power cord or plug is impaired, do not use it, it may cause fire or electric shock.
- The plug-socket combination must be accessible at all times because it serves as the main disconnecting device.
- Do not drop, knock or shake it. Rough handling can break internal circuit boards.
- Do not install the device in places where there is direct sunlight. Also do not put the device on carpets or cushions. It may cause fire or breakdown.
- Avoid exposure the phone to high temperature, below 0°C or high humidity.

Avoid wetting the unit with any liquid.

- Do not attempt to open it. Non-expert handling of the device could damage it. Consult your authorized dealer for help, or else it may cause fire, electric shock and breakdown.
- Do not use harsh chemicals, cleaning solvents, or strong detergents to clean it. Wipe it with a soft cloth that has been slightly dampened in a mild soap and water solution.
- When lightning, do not touch power plug or phone line, it may cause an electric shock.
- Do not install this phone in an ill-ventilated place.
- You are in a situation that could cause bodily injury. Before you work on any equipment, be aware of the hazards involved with electrical circuitry and be familiar with standard practices for preventing accidents.

# Table of Content

<b>1</b>	<b>INTRODUCING VOIP PHONE .....</b>	<b>6</b>
1.1	SIMPLE INTRODUCTION .....	6
1.2	DELIVERY CONTENT.....	6
1.3	KEYPAD.....	7
1.4	PORT FOR CONNECTING .....	8
1.5	ICON INTRODUCTION .....	9
1.6	LED INTRODUCTION.....	10
<b>2</b>	<b>INITIAL CONNECTING AND SETTING .....</b>	<b>12</b>
2.1	CONNECT THE PHONE .....	12
2.1.1	Connect to network.....	12
2.1.2	Power adaptor connection.....	13
2.2	BASIC INITIALIZATION .....	13
2.2.1	Network settings .....	13
<b>3</b>	<b>BASIC FUNCTION .....</b>	<b>15</b>
3.1	MAKING A CALL .....	15
3.1.1	Call Device .....	15
3.1.2	Call Methods.....	15
3.2	ANSWERING A CALL .....	15
3.3	DND.....	16
3.4	CALL FORWARD .....	16
3.5	CALL HOLD .....	16
3.6	CALL WAITING .....	16
3.7	MUTE .....	16
3.8	CALL TRANSFER .....	17
3.9	3-WAY CONFERENCE CALL.....	17
3.10	MULTIPLE-WAY CALL.....	17
<b>4</b>	<b>ADVANCED FUNCTION.....</b>	<b>19</b>
4.1	CALL PICKUP .....	19
4.2	JOIN CALL .....	19
4.3	REDIAL / UNREDIAL.....	19
4.4	CLICK TO DIAL.....	20
4.5	CALL BACK.....	20
4.6	AUTO ANSWER.....	20
4.7	HOTLINE.....	20
4.8	APPLICATION .....	20
4.8.1	SMS .....	20
4.8.2	Memo.....	21
4.8.3	Voice Mail.....	21

4.9	PING .....	21
4.10	PROGRAMMABLE KEY CONFIGURATION.....	21
<b>5</b>	<b>OTHER FUNCTIONS.....</b>	<b>25</b>
5.1	AUTO HANDDOWN .....	25
5.2	BAN ANONYMOUS CALL.....	25
5.3	BAN OUTING .....	25
5.4	DIAL PLAN.....	25
5.5	DIAL PEER .....	25
5.6	AUTO REDIAL .....	26
5.7	CALL COMPLETION .....	26
5.8	RING FROM HEADSET .....	26
5.9	POWER LIGHT .....	26
5.10	HIDE DTMF .....	26
5.11	PASSWORD DIAL.....	26
5.12	PRE DIAL .....	27
5.13	ACTION URL & ACTIVE URI.....	27
5.14	PUSH XML.....	27
<b>6</b>	<b>BASIC SETTING.....</b>	<b>28</b>
6.1	KEYBOARD .....	28
6.2	SCREEN SET.....	28
6.3	RINGER SET .....	28
6.4	VOICE VOLUME.....	28
6.5	TIME & DATE .....	28
6.6	GREETING WORD.....	29
6.7	LANGUAGE SETTING.....	29
<b>7</b>	<b>ADVANCED SETTINGS .....</b>	<b>30</b>
7.1	ACCOUNT .....	30
7.2	NETWORK.....	30
7.3	SECURITY .....	30
7.4	MAINTENANCE .....	30
7.5	FACTORY RESET.....	30
<b>8</b>	<b>WEB CONFIGURATION.....</b>	<b>31</b>
8.1	INTRODUCTION OF CONFIGURATION .....	31
8.1.1	Ways to configure.....	31
8.1.2	Password Configuration.....	31
8.2	SETTING VIA WEB BROWSER.....	31
8.3	CONFIGURATION VIA WEB.....	32
8.3.1	BASIC .....	32
8.3.2	Network .....	37
8.3.3	VOIP.....	45
8.3.4	Phone .....	59

8.3.5	Function Key .....	76
8.3.6	Maintenance.....	79
8.3.7	Security.....	88
8.3.8	Logout.....	93
<b>9</b>	<b>APPENDIX.....</b>	<b>94</b>
9.1	SPECIFICATION .....	94
9.1.1	Hardware .....	94
9.1.2	Voice features .....	94
9.1.3	Network features.....	95
9.1.4	Maintenance and management.....	96

# 1 Introducing VoIP Phone

## 1.1 Simple Introduction

Thank you for your purchasing DPH-400G/DPH-400GE. DPH-400G/DPH-400GE is a full-feature telephone that provides voice communication over the same data network that your computer uses. This phone functions not only much like a traditional phone, allowing to place and receive calls, and enjoy other features that traditional phone has, but also it owns many data services features which you could not expect from a traditional telephone. This guide will help you easily using the various features and services available on your phone.

## 1.2 Delivery Content







Please check whether the delivery contains the following parts:



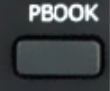

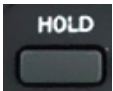

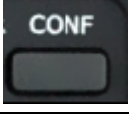
<b>Item</b>	<b>Description</b>
<b>IP Phone</b>	DPH-400G/DPH-400GE Phone with display and keypad.
<b>Power Adapter</b>	Power supply for telephone.
<b>Network Cable</b>	Used to access network for the phone.
<b>Handset</b>	Make phone calls with the phone's basic functions.
<b>Handset Cord</b>	Connected with the handset and the phone.
<b>Quick Installation Guide</b>	Quick install the DPH-400G/DPH-400GE guide.
<b>CD</b>	Containing manual and quick installation guide.
<b>Warranty Safety Information</b>	Warranty Safety Information for DPH-400G/DPH-400GE .

IP Phone are designed to look like conventional phones, the following photo shows a broad overview of the IP Phone.

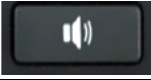



### 1.3 Keypad



Key	Key name	Function Description
	Navigation	Navigation keys assist users for operating. In idle state they have special function. You can configure through the web page according to your patterns of use.
	Phonebook	Access to phone book, check the record list and add new records and revise the record. When check the phone book record, press this key again will return to idle mode.
	Mute	Press this key in calling mode, you can hear the other side, and the other side cannot hear you.
	Hold	Temporarily hold the active call during the talking; press the key again to unhold the call. You also can press this key then input the third party's phone number and end with the # key during calling; you can make a call with the third party and hold the previous calling.
	Transfer	Use the key to realize blind transfer or attended transfer.
	Conference	Use this key to realize the three party call.
	Volume +/-	Turn down or turn up the volume by pressing these two keys.

	Redial	<ol style="list-style-type: none"> <li>1. In the hook off /hands-free mode, use the key to dial the last call number.</li> <li>2. In stand-by mode, it has a function to check the Outgoing Call.</li> </ol>
	Hands-free	Make the phone into hands-free mode.
	Indicator light	If power on, the indicator is light.
	Soft key 1/2/3/4	Keys combination, include functions such as History/PBook /DND /Menu /Del /Redial /Send / Quit/Answer/Divert/Reject/Hold/Transfer/Conf/Close and so on.
	Call logs	View the Missed call, Incoming Call and dialed Call.
	Digital keyboard	Inputting the phone number or DTMF.
	DSS keys	Programmable keys to let you customize with different functions. You can configure them in the web page.













## 1.4 Port for connecting

Port	Port name	description
	Power switch	Input: 5V AC, 1A.
	WAN	10/100M Connect it to Network.
	LAN	10/100M Connect it to PC.



	Headset	Port type: RJ-9 connector.
	Handset	Port type: RJ-9 connector.
	External console interface	Port type: RJ-11 direct connector.

## 1.5 Icon introduction

Icon	Description
	Call out.
	Call in.
	Call hold.
	Auto answer.
	Call mute.
	Contact.
	DND(Do not Disturb).
	In hand free mode.
	In handset mode.
	In headset mode.
	SMS.
	Missed call.
	Call forward.

## 1.6 LED introduction

Table 1 Programmable key LEDs for BLF

LED Status	Description
Steady green	The object is in idle status.
Slow blinking red	The object is ringing.
Steady red	The object is active.
Fast blinking red	The object is failed.
Off	The object is failed/ No subscribe

Table 2 Programmable key LEDs for Presence

LED Status	Description
Steady green	The object is online.
Slow blinking red	The object is ringing.
Steady red	The object is active.
Fast blinking red	The object is failed.
Off	The object is failed/ No subscribe

Table 3 Line key LEDs

LED Status	Description
Steady green	The account is active
Fast Blinking green	There is an incoming call to the account
Slow Blinking green	The call is on hold/ Registration is unsuccessful
Off	The line is unapplied or idle

Table 4 Programmable key LEDs for line

LED Status	Description
Steady green	The account is active
Fast Blinking green	There is an incoming call to the account
Slow Blinking green	The call is on hold
Slow Blinking red	Registration is unsuccessful
Off	The line is not unapplied or idle

Table 5 Programmable key LEDs for MWI

LED Status	Description
Blinking green	There are new voice mails
Off	There is no new voice mail

Table 6 Power Indication LED

LED Status	Description
Steady red	Power on.
Fast Blinking red	There is an incoming call.

Off	Power off.
-----	------------

## 2 Initial connecting and Setting

### 2.1 Connect the phone

#### 2.1.1 Connect to network

Step 1: Connect the IP Phone to the corporate IP telephony network. Before you connect the phone to the network, please check if your network can work normally.

You can do this in one of two ways, depending on how your workspace is set up. Direct network connection—by this method, you need at least one available Ethernet port in your workspace. Use the Ethernet cable in the package to connect WAN port on the back of your phone to the Ethernet port in your workspace. Since this VoIP Phone has router functionality, whether you have a broadband router or not, you can make direct network connect. The following two figures are for your reference.

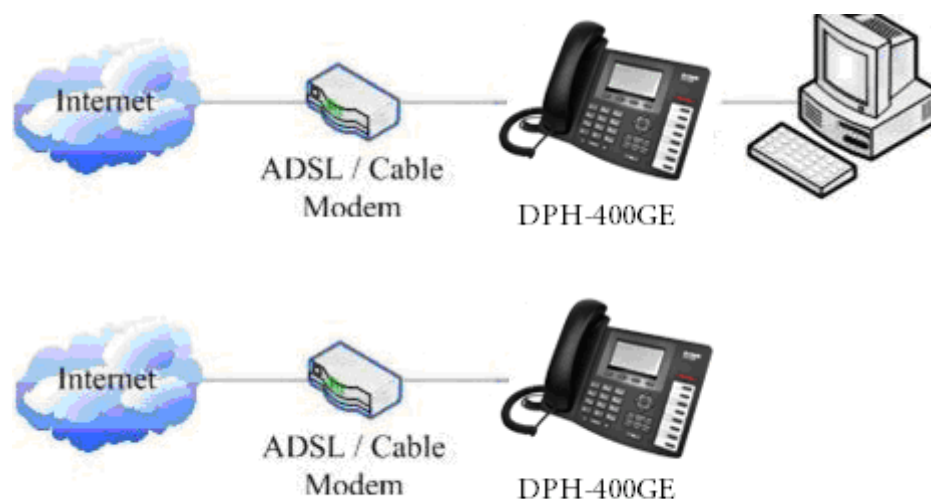

Shared network connection—Use this method if you have a single Ethernet port in your workspace with your desktop computer already connected to it. First, disconnect the Ethernet cable from the computer and attach it to the WAN port on the back of your phone. Next, use the Ethernet cable in the package to connect LAN port on the back of your phone to your desktop computer. Your IP Phone now shares a network connection with your computer. The following figure is for your reference.

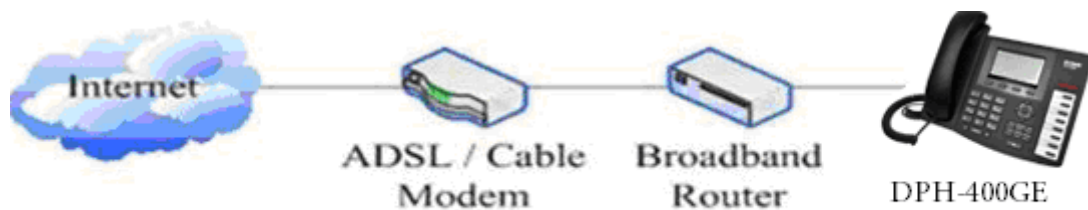

Step 2: Connect the handset to the handset port by the handset cable in the package.

Step 3: connect the power supply plug to the DC 5V adapter port on the back of the phone. Use the power cable to connect the power supply to a standard power outlet in your workspace.

If your LCD screen displays different information from the above, you need refer to the next section “Initial setting” to set your network online mode.

If your VoIP phone registers into corporate IP telephony Server, your phone is ready to use.

## 2.1.2 Power adaptor connection

Make sure that the power you use is comply with the parameters of power adaptor.

1. Plug power adaptor to power socket.
2. Plug power adaptor’s DC output to the DC5V port of DPH-400G/DPH-400GE to start up.
3. There will be displayed black line and “initializing... wait logon...” on the screen. After finishing startup, phone will show greeting, current date and time and so forth.
4. If phone has registered to the server, you can place or answer calls.

## 2.2 Basic Initialization

DPH-400G/DPH-400GE is provided with a plenty of functions and parameters for configuration. User needs some network and VoIP knowledge so that user could understand the meanings of parameters. In order to make user use the phone more easily and convenient, there are basic configurations introduced which is mandatory to ensure phone calls.

### 2.2.1 Network settings

Make sure that network is connected already before setting network of phone. DPH-400G/DPH-400GE uses DHCP to get WAN IP configurations, so phone could access to network as long as there is DHCP server in it. If there is no

DHCP server available, phone has to be changed WAN network setting to Static IP or PPPoE.

### **Setting PPPoE mode (for ADSL connection)**

1. Get PPPoE account and password first.
2. Press Menu->Settings->Advanced Setting, then enter passwords, and choose network ->WAN->Net Mode, enter and choose PPPoE through navigation keys and press the Save key.
3. Press Quit, then choose PPPoE Set, press Enter.
4. The screen will show the current information. Press Del to delete it, then input your PPPoE user and password and press Save.
5. Press Quit six times to return to the idle screen.
6. Check the status. If the screen shows “**Negotiating...**” it shows that the phone is trying to access to the PPPoE Server; if it shows an IP address, then the phone has already get IP with PPPoE.

### **Setting Static IP mode (static ADSL/Cable, or no PPPoE / DHCP network)**

1. Prepare the network's parameters first, such as IP Address, Net mask, Default Gateway and DNS server IP address. If you don't know this information, please contact the service provider or technician of network.
2. Press Menu->Settings->Advanced Setting, then enter passwords, and choose network ->WAN->Net Mode, enter and choose Static through navigation keys and press the Save key.
3. Press Quit, then choose Static Set, press Enter.
4. The screen will show the current information, and then press Del to delete. Input your IP address, Mask, Gateway, DNS and press Save to save what you input.
5. Press Quit six times to return to the idle screen.
6. Check the status, the screen shows “**Static**” .the screen shows the IP address and gateway which were set just now, if the phone could display the right time, it shows that Static IP mode takes effect.

### **Setting DHCP mode**



1. Press Menu->Settings->Advanced Setting, then enter passwords, and choose network ->WAN->Net Mode, enter and choose DHCP through navigation keys and press the Save key.
2. Press Quit six times to return to the idle screen.
3. Check the status, the screen shows “**DHCP**”, If the screen shows the IP address and gateway which were set just now, it shows that DHCP mode takes effect.

## 3 Basic function

### 3.1 Making a call

#### 3.1.1 Call Device

You can make a phone call via the following devices:

1. Pick up the handset,  icon will be showed in the idle screen.
2. Press the Speaker button,  icon will be showed in the idle screen.
3. Press the Headset button if the headset is connected to the Headset Port in advance. The icon  will be showed in the idle screen.

You can also dial the number first, and then choose the method you will use to speak to the other party.

#### 3.1.2 Call Methods

You can press an available line button if there is more than one account, then

1. Dial the number you want to call.
  2. Press History softkey, use the navigation buttons to highlight your choice (press Left/Right button to choose Missed Calls, Incoming Calls and Outgoing Calls.
  3. Press the RD button to call the last number called.
  4. Press the programmable keys which are set as speed dial button.
- Then press the Send button or Send softkey to make the call if necessary.

### 3.2 Answering a call

#### Answering an incoming call

1. If there is no other calling, you could choose the handle or press the speaker button or use softkey-answer or press the headset to accept the call.
2. If you are on another call, press the fluctuation navigation key to answer the new call.

During the conversation, you can alternate between Headset, Handset and Speaker phone by pressing the corresponding buttons or picking up the handset.

### 3.3 DND

Press the DND softkey to active DND Mode. New incoming calls will be rejected and the display will show:  icon. Press the DND softkey to choose deactivate DND mode. Incoming calls will be stored in the Call History.

### 3.4 Call Forward

This feature allows you to forward an incoming call to another phone number. The display showed  icon.

The following call forwarding events can be configured:

**Off:** Call forwarding is deactivated by default.

**Always:** Incoming calls are immediately forwarded.

**Busy:** Incoming calls are immediately forwarded when the phone is busy.

**No Answer:** Incoming calls are forwarded when the phone is not answered after a specific period.

To configure Call Forward via Phone interface:

1. Press Menu ->Features->Enter->Call Forward->Enter.
2. There are 4 options: Off, Always, Busy, No Answer.
3. If you choose one of them (except Off), enter the phone number you want to forward your calls to. Press Save to save the changes.

### 3.5 Call Hold

1. Press the Hold button or Hold softkey to put your active call on hold.
2. If there is only one call on hold, press the hold softkey to retrieve the call.
3. If there are more than one call on hold, press the line button, and the Up/Down button to highlight the call, then press the Unhold button to retrieve the call.

### 3.6 Call Waiting

1. Press Menu ->Features->Enter->Call Waiting->Enter.
2. Use the navigation keys to active or inactive call waiting.
3. Then press the Save to save the changes.

### 3.7 Mute

Press Mute button during the conversation, icon  will be showed in the LCD.

Then the called will not hear you, but you can hear the called. Press it again to



get the phone to normal conversation.

### **3.8 Call transfer**

#### **1. Blind Transfer**

During talk, press the key Transf, and then dial the number that you want to transfer to, and finished by "#". Phone will transfer the current call to the third party. After finishing transfer, the call you talk to will be hanged up. User cannot select SIP line when phone transfers call.

#### **2. Attended Transfer**

During talk, press the key Transf, then input the number that you want to transfer to and press Send. After that third party answers, then press Transfer to complete the transfer. (You need enable call waiting and call transfer first). If there are two calls, you can just talk to one, and keep hold to the other one. The one who is keep hold cannot speak to you or hear from you. In other way, if user wants to invite the third party during the call, they can press Conf to make calls mode in conference mode. If user wants to stop conference, user can press Split. (User must enable call waiting and three way call first).

Note: the server that user uses must support RFC3515 or it might not be used

#### **3. Semi-attended Transfer**

During the talk, press Transf firstly, and then press Send after inputting the number that you want to transfer. You are waiting for connection, now, press Transf and the transfer will be done. (To use this feature, you need enable call waiting and call transfer first).

### **3.9 3-way conference call**

1. Press the Conf softkey during an active call.
2. The first call is placed on hold. Then you will hear a dial tone. Dial the number to conference in, then press Send key.
3. When the call is answered, press Conf and add the first call to the conference.
4. If you want to release the conference, press Split key.

Note: the server that user uses must support RFC3515 or it might not be used (User must enable call waiting and three way call first).

### **3.10 Multiple-way call**

In this phone you can registe 5 SIP account numbers and the 5 accuonts can be used at the same time. There are four keys used as SIP line toleranted to make calls in SIP accounts. It will blink when the account registered failed.

In order to convenience the enterprise the phone support multiple call answering ,

call hold and multi-line call. The user can answer 10 incoming call phones at most, you can choose any call through pressing the fluctuation navigation key in talking and the other 9 calls will be in held. You also can press the fluctuation navigation key to change the call and recover the talking then last call will be held automatic. You also can define the four line keys as multi-line keys, then each line key will relate to a call and you can choose the talking through pressing the line keys and recover the talking and the light to the line key will bright all the time when in taking, then the light of the call in held is sparking.

If user has 5 line calls and wants to invite the five party during the call, they can press Conf or Transf "New Call", press OK, enter the number, then press Send and wait for the other party to answer. When the multiple-way calls, you can press the arrow keys to select a call.

## 4 Advanced function

### 4.1 Call pickup

Call pickup is implemented by simulating pickup function of PBX. it's that, when A calls B, B rings but no answer, at this moment, C can hook off and input an appointed prefix plus B's number, pick up A's call and talk with A.

The following chart shows how to configure an appointed prefix in dial peer to have call pick up function.

Dial Peer Table						
Number	Destination	Port	Mode	Alias	Suffix	Deleted Length
*1*T	0.0.0.0	5060	SIP	rep:pickup	no suffix	3

\*1\* means appointed prefix code. After making the above configuration, C can dial \*1\* plus B's phone number to pick up A's call. User can set prefix in random, in the case of no affecting current dialing rules.

### 4.2 Join call

When B is calling C, A can join in the existing call by inputting an appointed prefix numbers plus B or C number, if B or C also supports join call.

The following chart shows how to configure an appointed prefix in dial peer to have join call function.

Number	Destination	Port	Mode	Alias	Suffix	Deleted Length
*2*T	0.0.0.0	5060	SIP	rep:joincall	no suffix	3

\*2\* means appointed prefix code. After making the above configuration, A can dial \*2\* plus B or C number to join B and C's call. User can set prefix in random, in the case of no affecting current dialing rules.

### 4.3 Redial / Unredial

If B is in busy line when A calls B, A will get notice: busy, please hang up. If A want to connect B as soon as B is in idle, he can use redial function at the moment and he can dials an appointed prefix number plus B's number to realize redial function.

What is redial function? A can't not build a call with B when B is in busy, then A will subscribe B's calling mode at 60 second intervals. Once B is available, A will get reminder of rings to hook off, while A hooks off, A will call B automatically. If at this time A is occupied temporarily and unwilling to contact B, A also can cancel the redial function by dialing an appointed prefix plus B's

number before making the redial function.

*3*T	0.0.0.0	5060	SIP	rep:redial	no suffix	3
*4*T	0.0.0.0	5060	SIP	rep:unredial	no suffix	3

\*3\* is appointed prefix code. After making the above configuration, A can dial \*3\* plus B's phone number to make the redial function.

\*4\* is appointed prefix code. After configuration, A can dial \*4\* to cancel redial function.

User can set prefix in random, in the case of no affecting current dialing rules.

## 4.4 Click to dial

When user A browses in an appointed Web page, user A can click to call user B via a link (this link to user B), then user A's phone will ring, after A hooks off, the phone will dial to B.

## 4.5 Call back

This function allows you dial out the last phone call you received.

## 4.6 Auto answer

When there is an incoming call, after no answer time, the phone will answer the call automatically.

## 4.7 Hotline

You can set hotline number for every sip, and then enter the dialer interface and after Warm Line Time, the phone will call out the hotline number automatically.

## 4.8 Application

### 4.8.1 SMS

- 1) Press Menu ->Application->Enter->SMS->Enter.
- 2) Use the navigation keys to highlight the options. You can read the message in the Inbox/Outbox.
- 3) After view the new message, you can press Reply to reply the message, and use the 123 softkey to change the Input Method, when enter the reply message, press OK, then use the navigation keys to select the line from which you want to

send, then Send.

4) If you want to write a message, you can press New and enter message. Use the 123 softkey to change the Input Method. When you input the message you want to send, press OK, then use the navigation keys to select the line from which you want to send, then Send.

5) If you want to delete the message, after view the message, press Del, then you have three options to choose: Yes, All, No.

## **4.8.2 Memo**

You can add some memos to record some important things to remind you.

Press Menu->Application->Memo->Enter->Add.

There are some options to configure: Mode, Date, Time, text, Ring. When the configuration is completed, press Save.

## **4.8.3 Voice Mail**

1) Press Menu->Voice Mail->Enter.

2) Use the navigation keys to highlight the line for which you want to set, press Edit, and use the navigation key to turn on the mode, and the input the number. Press 123 softkey to choose the proper input method.

3) Press Save to save the change.

4) To view the new voicemail, Press the Voicemail softkey directly. Press Dial, then you may be prompted to enter the password, then you can listen to your new and old messages.

## **4.9 Ping**

1) Press Menu-> Application->ping>Enter.

2) Input the IP you want ,and press start key ,if input wrong, you can press “delete” to modification the IP.

3) After input the IP, wait a moment it will display”confirmation” , it meas ping successful ,or means ping failed.

## **4.10 Programmable Key Configuration**

The phone has 8 programmable keys which are able to set up to many functions per key. The following list shows the functions you can set on the programmable keys and provides a description for each function. The default configuration for each key is N/A which means the key hasn't been set for any functions.

1. Set the type as Memory Key

Press Menu->Settings->Basic Setting->Enter->DSS Key, you have two options:

Line As DSS Keys and Memory As DSS Keys, choose one you want to make the assignment, use the navigation key to choose the type as memory key. In the Dial field, you have some options, such as Normal, Speed Dial, Intercom, BLF, Presence, and MWI.

### **Speed dial**

You can configure the key as a simplified speed dial key. This key function allows you to easily access your most dialed numbers.

### **Intercom**

You can configure the key for Push to talk code and it is useful in an office environment as a quick access to connect to the operator or the secretary.

### **BLF**

BLF is also called “Busy lamp field”, and it is used to prompt the user to pay attention to the state of the object than has been subscribed, and used to cooperate with the server to pick up the phone call. You can configure the key for Busy Lamp Field (BLF) which allows you to monitor the status (idle, ringing, or busy) of other SIP account. User can dial out on a BLF configured key. Please refer to “LED Instruction” for more detail about the LED status in different situation.

Note: In the Web interface, you can also set the pickup number to active the pickup function. For example, if you set the BLF number as 212, and the pickup number is 189, then when there is an incoming call to 212, press the BLF key, it will call out the 189 automatically to pick up the incoming call on 212.

### **Presence**

Presence is called present, and compared to the BLF, it can also check whether object online.

Note: You can subscribe the BLF and presence station of the same number at the same time.

### **MWI**

When the key is configured as MWI, you are allowed to access voicemail quickly by pressing this key.

### **CALL PARK**

You need setting a server number, when you have set what represent Call park. If you have a calling and you busy now, you could press the key and hear a number, then you could choose other phone and input this number. so you can directly recover call..

### **Call forward**

When there is an incoming call, press the key and the incoming call can be transferred to the number set up.

2. Set the type as Line

You can set these keys as line keys, and press it, it will enter dialer interface.

3. Set the type as Key Event

You can set these keys as Key Event, and the subtype have many options.

Choose one and it will have corresponding function.

- None

- MWI
- DND (Do Not Disable)
- Hold
- Transfer
- Phone Book
- Redial
- Pick up
- Join
- Auto Redial On
- Auto Redial Off
- Call Forwarding
- History
- Flash
- Memo
- Headset
- Release: Press the key you can end the call.
- Lock: Press the key you can lock the keyboard.
- SMS
- Call Back
- Power Light
- Hide DTMF
- Prefix
- Hot Desking: Pressing the key, you can clear all sip information and register yourself sip information
- Agent

4. Set the type as Dtmf

You can configure the key as Dtmf. This key function allows you to easily dial or edit dial number.

5. Set the type as Remote

You need to match a XML Phonebook address, pressing the button you can directly access the corresponding remote phonebook.

6. Set the type as BLF List Key

It needs the cooperation with the Broadsoft server. The traditional BLF is that every number will need to be subscribed, so if the numbers that subscribed is so many that it will cause to obstruction. However, BLF List Key will put the numbers that needed to be subscribed in a group, and the phone use the URL of the group to subscribe and analyze the specific information of each number such as number, name, state and so on according to the notifications from the server. Then set the idle Memory key as BLF List Key, later if the state of an object changes, the corresponding LED will change.

7. set the type as Multicast

Set the multicast address and audio code, press this key to initiate the multicast.

Notice: Detailed feature see 8.3.4.7



## **5 Other functions**

### **5.1 Auto Handdown**

1. Press Menu ->Features-> Enter->Auto Handdown-> Enter.
2. Set the Mode Enable through the navigation key, then set Time, unit is minute, then press Save.
3. When the call ends, after the time that you have set, the phone will back to the idle interface.

### **5.2 Ban Anonymous Call**

1. Press Menu ->Features-> Enter->Ban Anonymous Call-> Enter.
2. Choose which sip you want to enable Ban Anonymous Call, and then press Enter, choose Enabled or Disabled through navigation key.
3. If you choose Enabled, the others can't call the phone by anonymous. If you choose Disabled, the others can call the phone by anonymous.

### **5.3 Ban Outing**

1. Press Menu ->Features-> Enter->ban outgoing> Enter
- 2.Enable the function, then you can not call any number.

### **5.4 Dial Plan**

1. Press Menu ->Features-> Enter->Dial Plan-> Enter.
2. The following plans you can set: Press # to Send, Timeout to Send, Timeout, Fixed Length Number, Press # to Do BXFER, BXFER On Onhook, AXFER On Onhook. You can enable or disable each dial plan.

### **5.5 Dial Peer**

1. Press Menu ->Features-> Enter->Dial Peer-> Enter.
2. Press Add to enter the Edit interface, and then input some information. For example: Number: 1T, Dest.: 0.0.0.0, Port: 5060, Mode: SIP, Alisa: all:3333, Suffix: no suffix, Del Len: 0. Then press Save. Then press Save.
3. Input 1+number (1234) in the dial interface, you can dial out 3333.  
You can refer to 8.3.3.4 DIAL PEER.

## **5.6 Auto Redial**

1. Press Menu ->Features-> Enter->Auto Redial-> Enter.
2. Choose Mode Enabled or Disabled through the navigation key. If you choose Enable, you also need to set Interval and Times, and then press Save.
3. After enable auto redial, calling out someone, if he is in busy, it will pop up a prompt box whether to auto redial, press OK, the phone will call out him according the Interval and Times that you set.

## **5.7 Call completion**

1. Press Menu ->Features-> Enter->Call Completion-> Enter.
2. Enable the function through the navigation key, and then Save .
3. Call out others, if he is in busy, it will pop up a prompt Call Completion Waiting number? Press OK, when he is in idle, it will pop up a prompt Call Completion Call number? Press OK, the phone will call out the number automatically.

## **5.8 Ring From Headset**

1. Press Menu ->Features-> Enter->Ring From Headset-> Enter.
2. Enable this function through the navigation key, the phone connects the headset, when the phone has an incoming call, it will ring from the headset.

## **5.9 Power Light**

1. Press Menu ->Features-> Enter->Power Light-> Enter.
2. Enable this function through the navigation key.

## **5.10 Hide DTMF**

1. Press Menu ->Features-> Enter->Hide DTMF-> Enter.
2. Through the navigation key to choose: Disabled, All, Delay, Last Show. When you set up a call with others and need to input the DTMF, the DTMF will show as you have set.

## **5.11 Password Dial**

1. Press Menu ->Features-> Enter->Password Dial-> Enter.
2. Enable this function, you can also set Prefix and Length. For example, you

want call out 1234567 and you set Password Dial Prefix 123 and Password Length 3, then enter the dial interface and input 1234567, and then the screen will show 123\*\*\*7.

## **5.12 Pre Dial**

1. Press Menu ->Features-> Enter->Pre Dial-> Enter.
2. Through navigation key to enable the feature,and to realize the Pre Dial function.

## **5.13 Action URL & Active URI**

1. Action URL: The action that the phone carries out e.g. open dnd can produces one URL, then the phone can send the HTTP Get of the URL to PC, then the phone can report the action to the PC.
2. Active URI: Enter the web page of the phone, PHONE->FEATURE, input Active URL Limit IP, You can input internet server (e.g. PC'IP), PC can send one URL to the phone, the phone will produce one action for example open dnd, so PC can control the phone.

## **5.14 Push XML**

Enter the web page of the phone->PHONE->FEATURE, input Push XML Server(e.g. PC'IP), then PC can push text, SMS, phonebook, advertisement,, execute etc. to phone to update the message or the phone makes an action.

# 6 Basic setting

## 6.1 Keyboard

1. Press Menu ->Settings-> Enter->Basic Setting-> Enter->Keyboard->Enter.
2. There are four items: DSS Keys, Multiplex, Long Click, SoftKey, You can set up respectively on them. Press the key Enter to the interface, then use the navigation keys to choose the function for the key according to you want.
3. Press the key OK to save.

## 6.2 Screen Set

1. Press Menu ->Settings-> Enter->Basic Setting-> Enter->Screen Set->Enter.
2. You can set Contrast and Brightness, press Enter and use the navigation keys to set, then press the key Save.

## 6.3 Ringer Set

1. Press Menu ->Settings-> Enter->Basic Setting-> Enter->Ringer Set->Enter.
2. You can set Ringer Volume and Ringer Type, press Enter and use the navigation keys to set, then press the key Save. In the Ringer Type, the default system rings have nine and the custom ringtones have five that can be set through the web page.

## 6.4 Voice Volume

1. Press Menu ->Settings-> Enter->Basic Setting-> Enter->Voice Volume->Enter.
2. Use the navigation keys to turn down or turn up the voice volume, the press the key Save.

## 6.5 Time & Date

1. Press Menu ->Settings->Enter->Basic Setting-> Enter->Time & Date->Enter.
2. You have two options to choose: Auto and Manual, use the navigation keys to choose, then press Save.

## **6.6 Greeting Word**

1. Press Menu ->Settings-> Enter->Basic Setting-> Enter->Greeting Word->Enter.
2. You can enter the message and press Save, it will display in the phone screen when the phone start up.

## **6.7 Language Setting**

1. Press Menu ->Settings-> Enter->Basic Setting-> Enter->Language->Enter.
2. DPH-400G/DPH-400GE support three languages, you can use the navigation keys to choose. The default two languages are English and Chinese.

# **7 Advanced settings**

## **7.1 Account**

Press Menu->Enter->Advanced settings, and then input the password to enter the interface, the default password is 123. You can set it through the web page. Then choose Account then press Enter, you can do some SIP settings.

## **7.2 Network**

Press Menu->Enter->Advanced settings, and then input the password to enter the interface. Then choose Network and press Enter, you can do network settings, you can refer to 2.2.1 Network settings.

## **7.3 Security**

Press Menu->Enter->Advanced settings, and then input the password to enter the interface. Then choose Security, you can configure Menu Password, Keylock Password, Keylock Status.

## **7.4 Maintenance**

Press Menu->Enter->Advanced settings, and then input the password to enter the interface. Then choose Maintenance and press Enter, you can configure Auto Provision, TR069, Backup, and Upgrade.

## **7.5 Factory Reset**

Press Menu->Enter->Advanced settings, and then input the password to enter the interface. Then choose Factory Reset and press Enter, you can choose Yes or No.

# 8 Web configuration

## 8.1 Introduction of configuration

### 8.1.1 Ways to configure

DPH-400G/DPH-400GE has three different ways to different users.

- Use phone keypad.
- Use web browser (recommendatory way).
- Use telnet with CLI command.

### 8.1.2 Password Configuration

There are two levels to access to phone: root level and general level. User with root level can browse and set all configuration parameters, while user with general level can set all configuration parameters except SIP (1~5) 's that some parameters cannot be changed, such as server address and port. User will has different access level with different username and password.

- Default user with general level:
  - ◆ username: guest
  - ◆ password: guest
- Default user with root level:
  - ◆ username: admin
  - ◆ password: admin

The default password of phone screen menu is 123.

## 8.2 Setting via web browser

When this phone and PC are connected to network, enter the IP address of the wan port in this phone as the URL (e.g. `http://xxx.xxx.xxx.xxx/` or `http://xxx.xxx.xxx.xxx:xxxx/`).

If you do not know the IP address, you can look it up on the phone's display by checking menu-Status.

The login page is as below picture

User:

Password:

## 8.3 Configuration via WEB

### 8.3.1 BASIC

#### 8.3.1.1 Status

**D-Link**

DPH-400GE // BASIC NETWORK VOIP PHONE MAINTENANCE SECURITY LOGOUT

STATUS  
WIZARD  
CALL LOG  
LANGUAGE

**WAN**

Connection Mode: DHCP  
MAC Address: 00:03:07:a9:b4:0b  
IP Address: 192.168.3.254  
IP Gateway: 192.168.1.1  
Bridge Mode: Enabled

**Accounts**

SIP Line 1:	@ :5060	Unapplied
SIP Line 2:	@ :5060	Unapplied
SIP Line 3:	@ :5060	Unapplied
SIP Line 4:	@ :5060	Unapplied
SIP Line 5:	@ :5060	Unapplied

BROADBAND

### Status

Field name	Explanation
WAN	Shows the configuration information on WAN port, including the connect mode of WAN port (Static, DHCP, PPPoE), MAC address, the IP address of WAN port, IP Gateway, ON or OFF bridge mode.
Accounts	Shows the phone numbers provided by the SIP LINE 1~5 servers.



The last line shows the version number.

### 8.3.1.2 Wizard

The screenshot shows the D-Link web interface for a DPH-400GE device. The top navigation bar includes tabs for BASIC, NETWORK, VOIP, PHONE, MAINTENANCE, SECURITY, and LOGOUT. The left sidebar contains links for STATUS, WIZARD (highlighted), CALL LOG, and LANGUAGE. The main content area is titled 'WAN Connection Mode' and features three radio button options: Static IP, DHCP (which is selected), and PPPoE. A 'Next' button is located below these options. At the bottom of the interface, there is a 'BROADBAND' section.

## Wizard

Please select the proper network mode according to the network condition. DPH-400G/DPH-400GE provide three different network settings:

- **Static:** If your ISP server provides you the static IP address, please select this mode, and then finish Static Mode setting. If you don't know about parameters of Static Mode setting, please ask your ISP for them.
- **DHCP:** In this mode, you will get the information from the DHCP server automatically; need not to input this information artificially.
- **PPPoE:** In this mode, you must input your ADSL account and password. You can also refer to 2.2.1 Network setting to speed setting your network.

Choose Static IP MODE, click **【NEXT】** can configure the network and SIP(default SIP1) simply, also can browse too. Click **【BACK】** can return to the last page.

**D-Link**

DPH-400GE / **BASIC** NETWORK VOIP PHONE MAINTENANCE SECURITY LOG

STATUS  
**WIZARD**  
 CALL LOG  
 LANGUAGE

**Static IP Settings**

IP Address: 192.168.2.40  
 Subnet Mask: 255.255.0.0  
 IP Gateway: 192.168.1.1  
 DNS Domain:  
 Primary DNS: 202.96.134.133  
 Secondary DNS: 202.96.128.68

Back Next

BROADBAND

IP Address	Input the IP address distributed to you.
Subnet Mask	Input the Netmask distributed to you.
IP Gateway	Input the Gateway address distributed to you.
DNS Domain	Set DNS domain postfix. When the domain which you input cannot be parsed, phone will automatically add this domain to the end of the domain which you input before and parse it again.
Primary DNS	Input your primary DNS server address.
Secondary DNS	Input your secondary DNS server address.

**D-Link**

DPH-400GE / **BASIC** NETWORK VOIP PHONE MAINTENANCE SECURITY LOG

STATUS  
**WIZARD**  
 CALL LOG  
 LANGUAGE

**Quick SIP Settings**

Display Name: 2041  
 Server Address: 192.168.1.2  
 Server Port: 5060  
 Authentication User: 2041  
 Authentication Password: ●●●●  
 SIP User: 2041  
 Enable Registration:

Back Next

BROADBAND

Display Name	Set the display name.
Server Address	Input your SIP server address.
Server Port	Set your SIP server port.
Authentication User	Input your SIP registered account name.
Authentication	Input your SIP registered password.

Password	
SIP User	Input the phone number assigned by your VOIP service provider.
Enable Registration	Start to register or not by selecting it or not.

The screenshot shows the D-Link router configuration interface. At the top is the D-Link logo. Below it is a navigation menu with tabs for BASIC, NETWORK, VOIP, PHONE, MAINTENANCE, SECURITY, and LOGO. The left sidebar contains links for STATUS, WIZARD, CALL LOG, and LANGUAGE. The main content area is titled 'WAN' and shows the following settings:

- Connection Mode: Static IP
- Static IP Address: 192.168.2.40
- IP Gateway: 192.168.1.1

Below the WAN settings is the 'SIP' section with the following settings:

- Server Address: 192.168.1.2
- Account: 2041
- Phone Number: 2041
- Registration: Enabled

At the bottom of the SIP section are 'Back' and 'Finish' buttons. The footer of the page says 'BROADBAND'.

Display detailed information that you manual configure.

Choose DHCP MODE, click **【NEXT】** can configure SIP(default SIP1) simply, also can browse too. Click **【BACK】** can return to the last page. Like Static IP MODE.

Choose PPPoE MODE, click **【NEXT】** can configure the PPPoE account/password and SIP(default SIP1) simply, also can browse too. Click **【BACK】** can return to the last page. Like Static IP MODE.

The screenshot shows the D-Link router configuration interface for PPPoE settings. At the top is the D-Link logo. Below it is a navigation menu with tabs for BASIC, NETWORK, VOIP, PHONE, MAINTENANCE, SECURITY, and LOGO. The left sidebar contains links for STATUS, WIZARD, CALL LOG, and LANGUAGE. The main content area is titled 'PPPoE Settings' and shows the following settings:

- Service Name: ANY
- User: user123
- Password: [masked]

At the bottom of the PPPoE settings section are 'Back' and 'Next' buttons. The footer of the page says 'BROADBAND'.

Service Name	It will be provided by ISP.
User	Input your ADSL account.

Password	Input your ADSL password.
Notice: Click <b>【Finish】</b> button after finished your setting, IP Phone will save the setting automatically and reboot, After reboot, you can dial by the SIP account.	

### 8.3.1.3 Call Log

You can query all the dialed calls through this page.

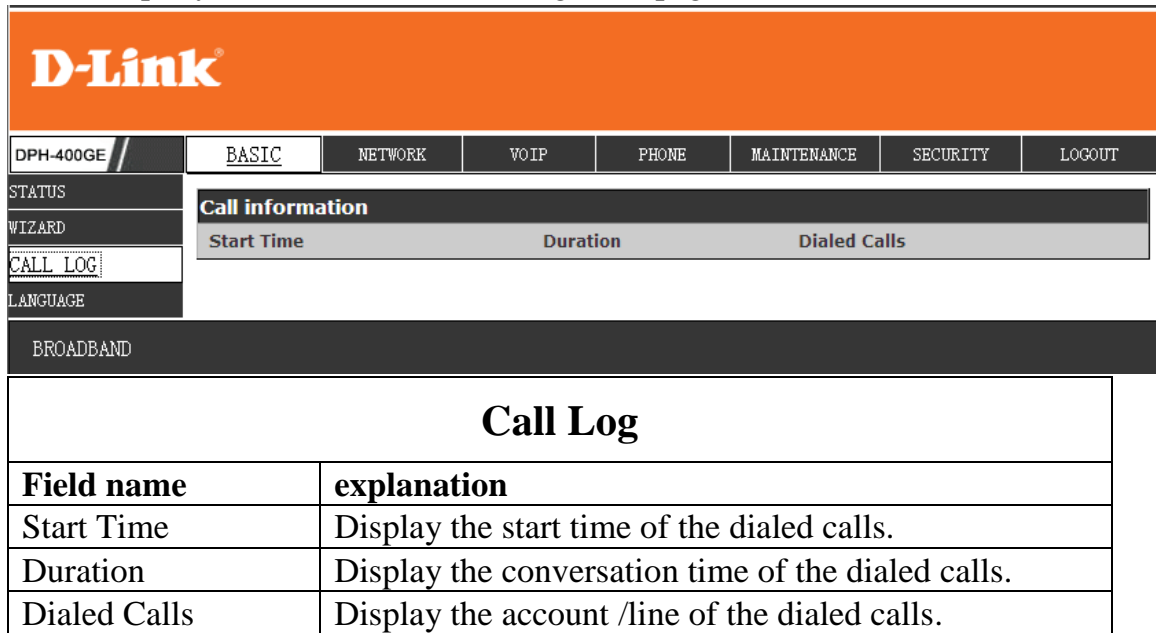

Field name	explanation
Start Time	Display the start time of the dialed calls.
Duration	Display the conversation time of the dialed calls.
Dialed Calls	Display the account /line of the dialed calls.

### 8.3.1.4 LANGUAGE

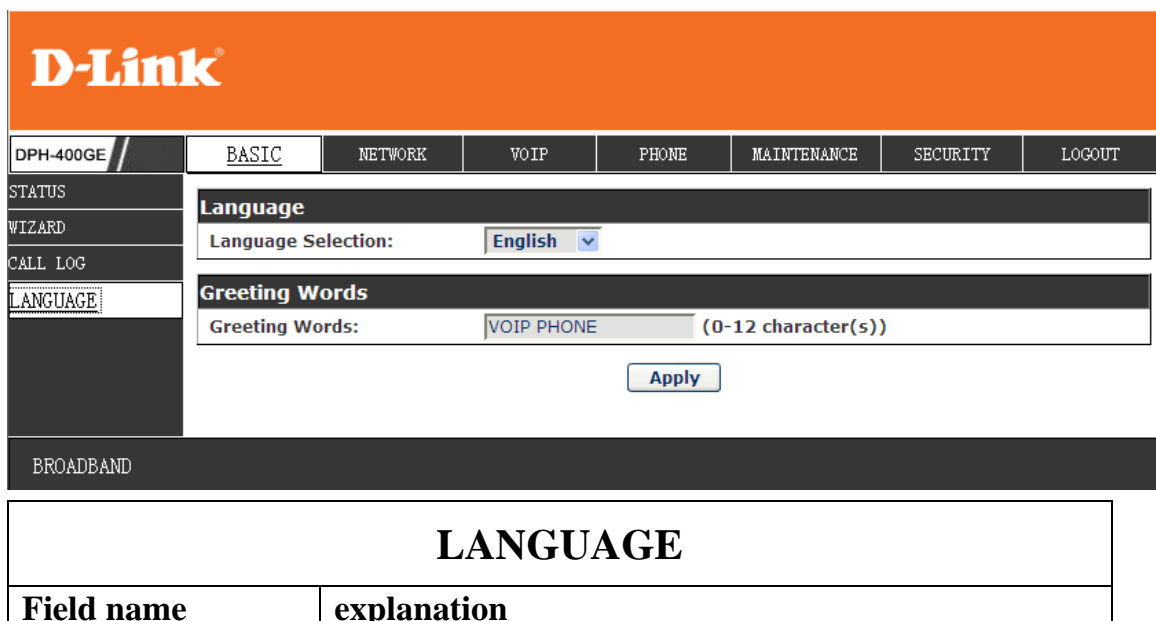

Field name	explanation
------------	-------------

Language	Set the language of phone, English is default.
Greeting Words	The greeting message will display on LCD when phone is idle. It can support 16 chars. the default chars are VOIP PHONE.
Notice: the maximal length of the greeting message is twelve English characters and five Chinese characters.	

## 8.3.2 Network

### 8.3.2.1 WAN

D-Link

<b>DPH-400GE</b>	BASIC	NETWORK	VOIP	PHONE	MAINTENANCE	SECURITY	LOGOUT
------------------	-------	---------	------	-------	-------------	----------	--------

WAN  
QOS&VLAN  
SERVICE PORT  
TIME&Date

#### WAN Status

Active IP Address:	192.168.2.40
Current Subnet Mask:	255.255.0.0
Current IP Gateway:	192.168.1.1
MAC Address:	00:03:07:a9:b4:0b
MAC Timestamp:	2013-10-22

#### WAN Settings

Static IP       DHCP       PPPoE

IP Address:	<input type="text" value="192.168.2.40"/>
Subnet Mask:	<input type="text" value="255.255.0.0"/>
IP Gateway:	<input type="text" value="192.168.1.1"/>
DNS Domain:	<input type="text"/>
Primary DNS:	<input type="text" value="202.96.134.133"/>
Secondary DNS:	<input type="text" value="202.96.128.68"/>

#### 802.1X Settings

802.1x Mode:	<input type="text" value="Disable"/>
Identity:	<input type="text" value="admin"/>
Password:	<input type="password" value="••••"/>
CA Certificate:	<input type="text"/> <input type="button" value="Browse"/> <input type="button" value="Upload"/>
Device Certificate:	<input type="text"/> <input type="button" value="Browse"/> <input type="button" value="Upload"/>

## WAN Status

WAN Status	
Active IP Address:	192.168.2.40
Current Subnet Mask:	255.255.0.0
Current IP Gateway:	192.168.1.1
MAC Address:	00:03:07:a9:b4:0b
MAC Timestamp:	2013-10-22
Active IP Address	The current IP address of the phone.
Current Subnet Mask	The current Netmask address.
MAC Address	The current MAC address of the phone.
Current IP Gateway	The current Gateway IP address.
MAC Timestamp	Shows the time of getting MAC address
WAN Settings	
Obtain DNS Server Automatically:	Enabled <input type="button" value="v"/>
Enable Vendor Identifier:	Disabled <input type="button" value="v"/>
Vendor Identifier:	DLINK DPH-400GE
Static IP <input type="radio"/>	DHCP <input checked="" type="radio"/> PPPoE <input type="radio"/>
<input type="button" value="Apply"/>	
<p>Please select the proper network mode according to the network condition. DPH-400G/DPH-400GE provide three different network settings:</p> <ul style="list-style-type: none"> <li>● Static: If your ISP server provides you the static IP address, please select this mode, and then finish Static Mode setting. If you don't know about parameters of Static Mode setting, please ask your ISP for them.</li> <li>● DHCP: In this mode, you will get the information from the DHCP server automatically; need not to input this information artificially.</li> <li>● PPPoE: In this mode, you must input your ADSL account and password. You can also refer to 2.2.1 Network setting to speed setting your network.</li> </ul>	
Obtain DNS server automatically	Select it to use DHCP mode to get DNS address, if you don't select it, you will use static DNS server. The default is selecting it.
Enable Vendor Identifier	Enable/Disabled Vendor Identifier
Vendor Identifier	Custom vendor identification
IP Address:	192.168.1.179
Subnet Mask:	255.255.255.0
IP Gateway:	192.168.1.1
DNS Domain:	
Primary DNS:	202.96.134.133
Secondary DNS:	202.96.128.68
<input type="button" value="Apply"/>	
If you use static mode, you need set it.	

IP Address	Input the IP address distributed to you.
Subnet Mask	Input the Netmask distributed to you.
IP Gateway	Input the Gateway address distributed to you.
DNS Domain	Set DNS domain postfix. When the domain which you input cannot be parsed, phone will automatically add this domain to the end of the domain which you input before and parse it again.
Primary DNS	Input your primary DNS server address.
Secondary DNS	Input your secondary DNS server address.
<p>Service Name: <input type="text" value="ANY"/></p> <p>User: <input type="text" value="user123"/></p> <p>Password: <input type="password" value="....."/></p> <p style="text-align: center;"><input type="button" value="Apply"/></p>	
If you uses PPPoE mode, you need to make the above setting.	
Service Name	It will be provided by ISP.
User	Input your ADSL account.
Password	Input your ADSL password.
<p>Notice:</p> <p>1) Click “Apply” button after finished your setting, IP Phone will save the setting automatically and new setting will take effect.</p> <p>2) If you modify the IP address, the web will not response by the old IP address. Your need input new IP address in the address column to logon in the phone.</p> <p>3) If networks ID which is DHCP server distributed is same as network ID which is used by LAN of system, system will use the DHCP IP to set WAN, and modify LAN’s networks ID (for example, system will change LAN IP from 192.168.10.1 to 192.168.11.1) when system uses DHCP client to get IP in startup; If system uses DHCP client to get IP in running status and network ID is also same as LAN’s, system will refuse to accept the IP to configure WAN. So WAN’s active IP will be 0.0.0.0.</p>	

### 8.3.2.2 Qos&VLAN

The VOIP phone support 802.1Q/P protocol and DiffServ configuration. VLAN functionality can use different VLAN IDs by setting signal/voice VLAN and data VLAN. The VLAN application of this phone is very flexible.

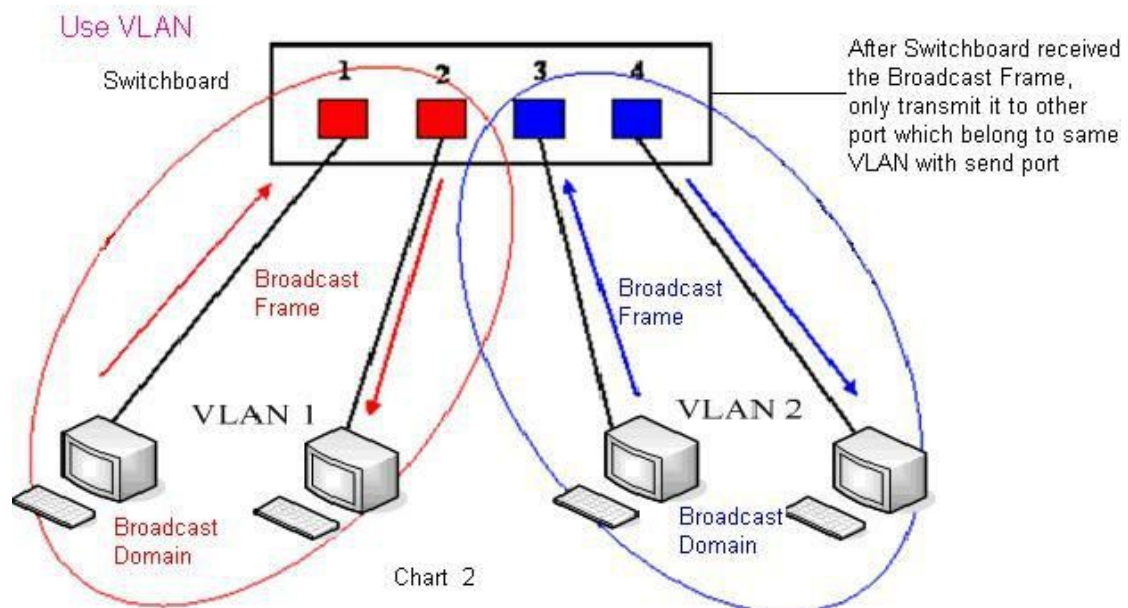
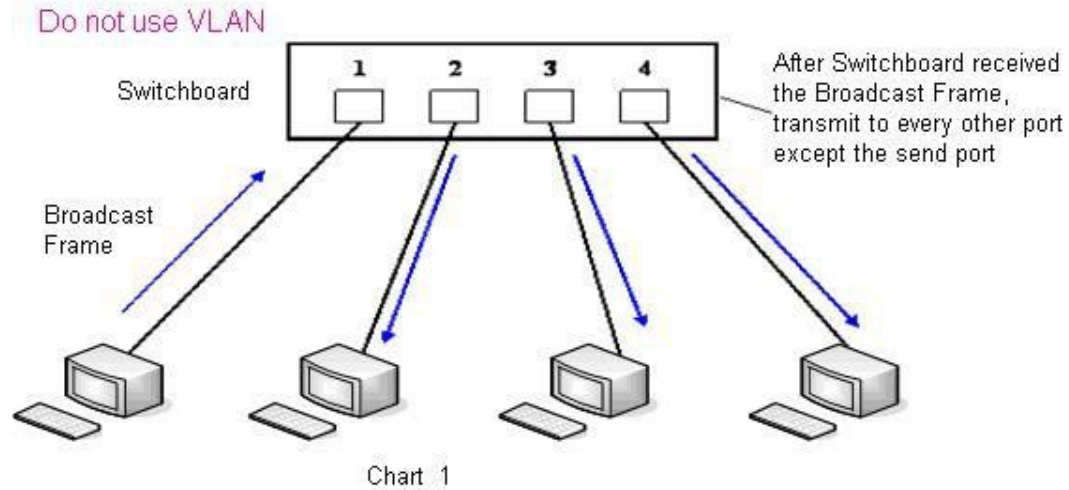

In chart 1, there is a layer 2 that switches without setting VLAN. Any broadcast frame will be transmitted to the other ports except the send port. For example, a broadcast information is sent out from port 1 then transmitted to port 2,3and 4.

In chart 2, red and blue indicate two different VLANs in the switch, and port 1 and port 2 belong to red VLAN, port 3 and port 4 belong to blue VLAN. If a broadcast frame is sent out from port 1, switch will transmit it to port 2, the other port in the red VLAN and not transmit it to port3 and port 4 in blue VLAN. By this means, VLAN divide the broadcast domain via restricting the range of broadcast frame transition.

Note: chart 2 use red and blue to identify the different VLAN, but in practice, VLAN uses different VLAN IDs to identify.



DPH-400GE	BASIC	<b>NETWORK</b>	VOIP	PHONE	MAINTENANCE	SECURITY	LOGOUT
WAN	<b>Link Layer Discovery Protocol (LLDP) Settings</b> Enable LLDP: <input type="checkbox"/> Enable Learning Function: <input type="checkbox"/> Packet Interval(1~3600): <input type="text" value="60"/> second(s)						
QoS&VLAN	<b>Quality of Service (Qos) Settings</b> Enable DSCP: <input type="checkbox"/> SIP DSCP: <input type="text" value="0"/> Audio RTP DSCP: <input type="text" value="0"/> (0~63)						
SERVICE PORT	<b>WAN Port VLAN Settings</b> Enable WAN Port VLAN: <input type="checkbox"/> WAN Port VLAN ID: <input type="text" value="0"/> (0~4095) SIP 802.1P Priority: <input type="text" value="0"/> (0~7) Audio 802.1P Priority: <input type="text" value="0"/> (0~7)						
TIME&Date	<b>LAN Port VLAN Settings</b> LAN Port VLAN Mode: <input type="text" value="Follow WAN"/> <input type="button" value="v"/> LAN Port VLAN ID: <input type="text" value="0"/> (0~4095)						
<input type="button" value="Apply"/>							
BROADBAND							

QoS & VLAN	
<b>LLDP Settings</b>	
Enable LLDP	Enable LLDP by selecting it.
Enable Learning Function	After enabling LLDP Learn, telephone can automatically learn the data of DSCP, 802.1p, VLAN ID from the switch. If the data is different from the data of the LLDP server, telephone will change its own value as the value of the switch (Synchronous with VLAN in switch).
Package Interval	The time interval of sending LLDP Packet.
<b>QoS Setting</b>	
Enable DSCP	Enable Dscp by selecting it.
SIP DSCP	Specify the value of the SIP Dscp.
Audio RTP DSCP	Specify the value of the Audio RTP Dscp.
<b>WAN Port VLAN Setting</b>	
Enable WAN Port VLAN	Enable WAN Port VLAN by selecting it.
WAN Port VLAN ID	Specify the value of the WAN Port VLAN ID, the range of the value is 0-4095.

SIP 8021.p Priority	Specify the value of the signal 802.1p priority, the range of the value is 0-7.
Audio 802.1p Priority	Specify the value of the voice 802.1p priority, the range of the value is 0-7.
<b>LAN Port VLAN Setting</b>	
LAN Port VLAN Mode	Follow WAN: Follow the WAN ID. Disable: Disable Port VALN. Enable: Enable Port VLAN and specify the Port VLAN ID different from WAN ID.
LAN Port VLAN ID	Specify the value of the Port VLAN ID different from WAN ID, the range of the value is 0-4095.

### 8.3.2.3 Service Port

You can set the port of telnet/HTTP/RTP by this page.

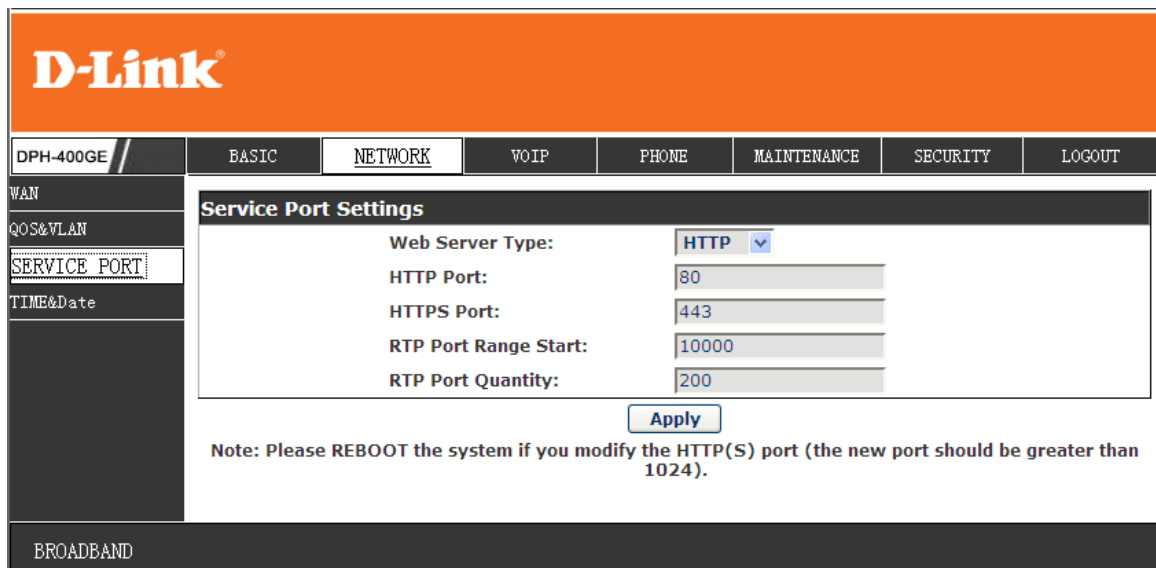

<b>SERVICE PORT</b>	
<b>Field name</b>	<b>explanation</b>
<b>Service Port Settings</b>	
Web Server Type	Specify Web Server Type with HTTP or HTTPS.
HTTP Port	Set web browser port, the default is 80 port, if you want to enhance system safety, you'd better change it into non-80 standard port; Example: The IP address is 192.168.1.70. and the port

	value is 8090, the accessing address is http://192.168.1.70:8090.
HTTPS Port	Before using the https, you must download https authentication certification into the phone, then set web browser port, the default is 443 port, if you want to enhance system safety, you'd better change it into non-443 standard port. You can access to the web in https after rebooting the phone.
Telnet Port	Set Telnet Port, the default is 23. You can change the value into others. Example: The IP address is 192.168.1.70. the telnet port value is 8023, the accessing address is telnet 192.168.1.70 8023.
RTP Port Range Start	Set the RTP Start Port. It is dynamic allocation.
RTP Port Number	Set the maximum quantity of RTP Port, the default is 200.
<p><b>Notice:</b></p> <ol style="list-style-type: none"> <li>1) You need save the configuration and reboot the phone after set this page.</li> <li>2) Please REBOOT the system if you modify the HTTP or telnet port number (the new number should be greater than 1024.)</li> <li>3) If you set 0 for the HTTP port, it will disable HTTP service.</li> </ol>	

#### 8.3.2.4 TIME&DATE

Setting time zone and SNTP (Simple Network Time Protocol) server according to your location, you can also manually adjust date and time in this web page.

DPH-400GE	BASIC	<u>NETWORK</u>	VOIP	PHONE	MAINTENANCE	SECURITY	LOGOUT
WAN	<b>Simple Network Time Protocol (SNTP) Settings</b>						
QOS&VLAN	Enable SNTP: <input checked="" type="checkbox"/>						
SERVICE PORT	Enable DHCP Time: <input type="checkbox"/>						
TIME&Date	Primary Server: <input type="text" value="209.81.9.7"/>						
	Secondary Server: <input type="text"/>						
	Timezone: <input type="text" value="(GMT+08:00)Beijing,Chongqing,Hong Kong,Urumqi"/>						
	Resync Period: <input type="text" value="60"/> second(s)						
	12-Hour Clock: <input type="checkbox"/>						
	Date Format: <input type="text" value="1 Jan Mon"/>						
	<input type="button" value="Apply"/>						
	<b>Daylight Saving Time Settings</b>						
	Enable: <input type="checkbox"/>						
	Offset: <input type="text" value="60"/> minutes(s)						
	Month: <input type="text" value="March"/>			Month: <input type="text" value="October"/>			
	Week: <input type="text" value="5"/>			Week: <input type="text" value="5"/>			
	Day: <input type="text" value="Sunday"/>			Day: <input type="text" value="Sunday"/>			
	Hour: <input type="text" value="2"/>			Hour: <input type="text" value="2"/>			
	Minute: <input type="text" value="0"/>			Minute: <input type="text" value="0"/>			
	<input type="button" value="Apply"/>						
	<b>Manual Time Settings</b>						
	Year: <input type="text"/>						
	Month: <input type="text"/>						
	Day: <input type="text"/>						
	Hour: <input type="text"/>						
	Minute: <input type="text"/>						
	<input type="button" value="Apply"/>						

## TIME&DATE

Field name	explanation
<b>Simple Network Time Protocol (SNTP) Settings</b>	
Enable SNTP	Enable SNTP by selecting it.
Enable DHCP Time	Enable DHCP Time by selecting it, then the phone will automatically synchronize the standard time.
Primary Server	Set SNTP Primary Server IP address.
Secondary Server	Set SNTP Secondary Server IP address.
Time Zone	Select the Time zone according to your location.
Resync Period	Set the time out, the default is 60 seconds.
12 -Hours Clock	Switch the time mechanism between 12 hours and 24 hours.

	Default is 24 hours mode.
Date format	Specify the date display format.
<b>Daylight Saving Time Settings</b>	
Enable	Enable daylight saving time.
Offset(minutes)	Setup the variety length.
Month	Setup start and end month.
Week	Setup start and end week.
Day	Setup start and end day.
Hour	Setup start and end hours.
Minute	Setup start and end minutes.
<b>Manual Time Settings</b>	
<div style="background-color: #333; color: white; padding: 2px;"><b>Manual Time Settings</b></div> <p>Year: <input type="text"/></p> <p>Month: <input type="text"/></p> <p>Day: <input type="text"/></p> <p>Hour: <input type="text"/></p> <p>Minute: <input type="text"/></p> <p style="text-align: right;"><input type="button" value="Apply"/></p>	
Notice: You need specify the above all items.	

## 8.3.3 VOIP

### 8.3.3.1 SIP

Set your SIP server in the following interface.



DPH-400GE	BASIC	NETWORK	<b>VOIP</b>	PHONE	MAINTENANCE	SECURITY	LOGOUT																																
<a href="#">SIP</a> <a href="#">STUN</a> <a href="#">DIAL PEER</a>	<div style="background-color: #333; color: white; padding: 2px;"><b>SIP Line Selection</b></div> <p>SIP 1 <input type="button" value="Load"/></p>																																						
<div style="background-color: #333; color: white; padding: 2px;"><b>Basic Settings &gt;&gt;</b></div> <table style="width: 100%; border-collapse: collapse;"> <tr> <td style="width: 30%;">Status:</td> <td style="color: red;">Registered</td> <td style="width: 30%;">Domain Realm:</td> <td><input type="text"/></td> </tr> <tr> <td>Server Address:</td> <td><input type="text" value="192.168.1.2"/></td> <td>Proxy Server Address:</td> <td><input type="text"/></td> </tr> <tr> <td>Server Port:</td> <td><input type="text" value="5060"/></td> <td>Proxy Server Port:</td> <td><input type="text"/></td> </tr> <tr> <td>Authentication User:</td> <td><input type="text" value="2041"/></td> <td>Proxy User:</td> <td><input type="text"/></td> </tr> <tr> <td>Authentication Password:</td> <td><input type="text" value="•••"/></td> <td>Proxy Password:</td> <td><input type="text"/></td> </tr> <tr> <td>SIP User:</td> <td><input type="text" value="2041"/></td> <td>Backup Server Address:</td> <td><input type="text"/></td> </tr> <tr> <td>Display Name:</td> <td><input type="text" value="2041"/></td> <td>Backup Server Port:</td> <td><input type="text" value="5060"/></td> </tr> <tr> <td>Enable Registration:</td> <td><input checked="" type="checkbox"/></td> <td>Server Name:</td> <td><input type="text"/></td> </tr> </table>								Status:	Registered	Domain Realm:	<input type="text"/>	Server Address:	<input type="text" value="192.168.1.2"/>	Proxy Server Address:	<input type="text"/>	Server Port:	<input type="text" value="5060"/>	Proxy Server Port:	<input type="text"/>	Authentication User:	<input type="text" value="2041"/>	Proxy User:	<input type="text"/>	Authentication Password:	<input type="text" value="•••"/>	Proxy Password:	<input type="text"/>	SIP User:	<input type="text" value="2041"/>	Backup Server Address:	<input type="text"/>	Display Name:	<input type="text" value="2041"/>	Backup Server Port:	<input type="text" value="5060"/>	Enable Registration:	<input checked="" type="checkbox"/>	Server Name:	<input type="text"/>
Status:	Registered	Domain Realm:	<input type="text"/>																																				
Server Address:	<input type="text" value="192.168.1.2"/>	Proxy Server Address:	<input type="text"/>																																				
Server Port:	<input type="text" value="5060"/>	Proxy Server Port:	<input type="text"/>																																				
Authentication User:	<input type="text" value="2041"/>	Proxy User:	<input type="text"/>																																				
Authentication Password:	<input type="text" value="•••"/>	Proxy Password:	<input type="text"/>																																				
SIP User:	<input type="text" value="2041"/>	Backup Server Address:	<input type="text"/>																																				
Display Name:	<input type="text" value="2041"/>	Backup Server Port:	<input type="text" value="5060"/>																																				
Enable Registration:	<input checked="" type="checkbox"/>	Server Name:	<input type="text"/>																																				

### Codecs Settings >>

#### Disabled Codecs

G. 711A  
G. 711U  
G. 722  
G. 723.1  
G. 726-32  
G. 729AB



#### Enabled Codecs

Empty list box for Enabled Codecs with scrollbars and arrow buttons.

### Advanced SIP Setting >>

Forward Type:	<input type="button" value="Disabled"/> ▾	Enable Hotline:	<input type="checkbox"/>
Forward Number:	<input type="text"/>	Hotline Number:	<input type="text"/>
No Ans. Fwd Wait Time:	<input type="text" value="60"/> (0~120)second(s)	Warm Line Wait Time:	<input type="text" value="0"/> (0~9)second(s)
Transfer Timeout:	<input type="text" value="0"/> second(s)	BLF Server:	<input type="text"/>
SIP Encryption:	<input type="checkbox"/>	Enable Auto Answer:	<input type="checkbox"/>
SIP Encryption Key:	<input type="text"/>	Auto Answer Timeout:	<input type="text" value="60"/> second(s)
RTP Encryption:	<input type="checkbox"/>	Enable Session Timer:	<input type="checkbox"/>
RTP Encryption Key:	<input type="text"/>	Session Timeout:	<input type="text" value="0"/> second(s)
Subscribe For MWI:	<input type="checkbox"/>	Conference Type:	<input type="button" value="Local"/> ▾
MWI Number:	<input type="text"/>	Conference Number:	<input type="text"/>
Subscribe Period:	<input type="text" value="3600"/> second(s)	Registration Expires:	<input type="text" value="3600"/> second(s)
Enable Service Code:	<input type="checkbox"/>		
DND On Code:	<input type="text"/>	DND Off Code:	<input type="text"/>
Always CFwd On Code:	<input type="text"/>	Always CFwd Off Code:	<input type="text"/>
Busy CFwd On Code:	<input type="text"/>	Busy CFwd Off Code:	<input type="text"/>
No Ans. CFwd On Code:	<input type="text"/>	No Ans. CFwd Off Code:	<input type="text"/>
Anonymous On Code:	<input type="text"/>	Anonymous Off Code:	<input type="text"/>
Keep Alive Type:	<input type="button" value="SIP Option"/> ▾	Keep Alive Interval:	<input type="text" value="60"/> second(s)
User Agent:	<input type="text"/>	Server Type:	<input type="button" value="COMMON"/> ▾
DTMF Type:	<input type="button" value="AUTO"/> ▾	RFC Protocol Edition:	<input type="button" value="RFC3261"/> ▾
DTMF SIP INFO Mode:	<input type="button" value="Send 10/11"/> ▾	Local Port:	<input type="text" value="5060"/>
Ring Type:	<input type="button" value="Default"/> ▾	Anonymous Call Edition:	<input type="button" value="None"/> ▾
Enable Rport:	<input type="checkbox"/>	Keep Authentication:	<input type="checkbox"/>
Enable PRACK:	<input type="checkbox"/>	Ans. With a Single Codec:	<input type="checkbox"/>
Enable Long Contact:	<input type="checkbox"/>	Auto TCP:	<input type="checkbox"/>
Convert URI:	<input checked="" type="checkbox"/>	Enable Strict Proxy:	<input type="checkbox"/>
Dial Without Registered:	<input type="checkbox"/>	Enable GRUU:	<input type="checkbox"/>
Ban Anonymous Call:	<input type="checkbox"/>	Enable Displayname Quote:	<input type="checkbox"/>
Enable DNS SRV:	<input type="checkbox"/>	Enable user=phone:	<input checked="" type="checkbox"/>
Enable Missed Call Log:	<input checked="" type="checkbox"/>	Click To Talk:	<input type="checkbox"/>
BLF List Number:	<input type="text"/>	Transport Protocol:	<input type="button" value="UDP"/> ▾
Enable BLF List:	<input type="checkbox"/>	Use VPN:	<input checked="" type="checkbox"/>
Respond 182 when Call waiting:	<input type="checkbox"/>	Enable DND:	<input type="checkbox"/>

SIP Global Settings >>			
Strict Branch:	<input type="checkbox"/>	Enable Group:	<input type="checkbox"/>
Registration Failure Retry Time:	<input type="text" value="32"/>	second(s)	
<input type="button" value="Apply"/>			

BROADBAND

SIP Config	
Field name	explanation
<b>SIP Line</b>	
Choose line to set info about SIP, there are 5 lines to choose. You can switch by <b>【Load】</b> button.	
<b>Basic Settings</b>	
Status	Shows if the phone has been registered the SIP server or not; or so, show Unapplied.
Server Address	Input your SIP server address.
Server Port	Set your SIP server port.
Authentication User	Input your SIP register account name.
Authentication Password	Input your SIP register password.
SIP User	Input the phone number assigned by your VoIP service provider. Phone will not register if there is no phone number configured.
Display Name	Set the display name.
Proxy Server Address	Set proxy server IP address(Usually, Register SIP Server configuration is the same as Proxy SIP Server. But if your VoIP service provider give different configurations between Register SIP Server and Proxy SIP Server, you need make different settings).
Proxy Server Port	Set your Proxy SIP server port.
Proxy User	Input your Proxy SIP server account.
Proxy Password	Input your Proxy SIP server password.
Domain Realm	Set the sip domain if needed, otherwise this VoIP phone will use the Register server address as sip domain automatically. (Usually it is same with registered server and proxy server IP address).
Backup Server Address	Input the Backup Server Address, if the primary server is unavailable , then the phone will enable the Backup Server Address
Backup Server Port	Specify the Backup Server Port

Server Name	Named the server
Enable Registration	Start to register or not by selecting it or not.
<b>Codecs Settings</b>	
Disable Codecs/Enable Codecs	Use the navigation keys to highlight the desired one in the Enable/Disable Codecs list, and press the desired to move to the other list.
<b>Advanced SIP Setting</b>	
Forward Type	<p>Select call forward mode, the default is Off</p> <p>Off: Close down calling forward</p> <p>Busy: If the phone is busy, incoming calls will be forwarded to the appointed phone.</p> <p>No answer: If there is no answer, incoming calls will be forwarded to the appointed phone after a specific.</p> <p>Always: Incoming calls will be forwarded to the appoint phone immediately. The phone will prompt the incoming while doing forward.</p>
Forward Number	Specify the number you want to forward.
No Answer Forward Wait Time	Specify the No Answer Forward Delay Time, if the Forward Type is No answer, incoming calls will be forwarded after the no answer forward wait time
Transfer Timeout	For the phone supports the transfer of certain special features server, set interval time between sending “bye” and hanging up after the phone transfers a call.
Enable Hot Line	Specify Hot Line by selecting it
Hot Line Number	Specify Hot Line Number, the phone dial the hot line number automatically at hands-free mode or handset mode after warm line time
Warm Line Wait Time	Specify the Warm Line Time
BLF Server	Ordinary BLF application is that the phone send subscription package to the registered server, if your server does not support subscription package, please input the BLF server so that it can separate register server and BLF server.
SIP Encryption	Enable/Disable SIP Encryption.



SIP Encryption Key	Set the key for sip encryption.
RTP Encryption	Enable/Disable RTP encryption.
RTP Encryption Key	Set the key for RTP encryption.
Enable Auto Answer	Enable Auto Answer by selecting it
Auto Answer Timeout	Specify Auto Answer Time, the phone auto answers the incoming call after Auto Answer Time
Enable Session Timer	Set Enable/Disable Session Timer, whether support RFC4028.It will refresh the SIP sessions.
Session Timeout	Set the session timeout
Subscribe for MWI	Enable the Subscribe for MWI by selecting it, the phone will send subscribe message for MWI to the SIP Server
MWI Number	Specify the MWI Number; Please contact your system administrator for the connecting code. Different systems have different codes.
Subscribe Period(s)	Overtime of resending subscribe packet. Suggest using the default configuration.
Conference Type	Specify the Conference Type, if you select the local, you needn't input the conference number
Conference Number	Specify the network conference number, please contact your system administrator for the network conference number
Registration Expire(s)	Set expire time of SIP server register, default is 60 seconds. If the register time of the server requested is longer or shorter than the expired time set, the phone will change automatically the time into the time recommended by the server, and register again.
Enable Service Code	If you want to realize the following function by the server, please enter the On Code and Off Code option, then when you choose to enable/disable following function on your IP phone, it will send message to the server, and the server will turn on/off the function immediately.
DND On Code	Set the DND On Code, When you press the DND hot key, the phone will send a message to the server, and the server will turn on the DND function. Then any calls to the extension will be rejected by the server automatically. And the incoming call record will not be displayed in the Call History.
DND Off Code	Set the DND Off Code, When you press the DND hot key, the phone will send a message to the server, and the server will turn off the DND function.
Always CFwd On Code	Set the Always CFwd On Code, when you choose to enable the always forward function on your phone, it

	will send message to the server, and the server will turn on the function immediately. When there are calls to the extension, the server will always forward it to the set number automatically. And the IP phone will not show the record in the call history anymore.
Always CFwd Off Code	Set the Always CFwd Off Code, when you choose to disable the always forward function on your phone, it will send message to the server, and the server will turn off the function immediately.
Busy CFwd On Code	Set the Busy CFwd On Code, when you choose to enable the busy forward function v on your phone, it will send message to the server, and the server will turn on the function immediately. When there are calls to the extension, the server will forward it to the set number automatically based the forward type. And the IP phone will not show the record in the call history anymore.
Busy CFwd Off Code	Set the Busy CFwd Off Code, when you choose to disable the busy forward function on your phone, it will send message to the server, and the server will turn off the function immediately.
No Answer CFwd On Code	Set the No Answer CFwd On Code, when you choose to enable the on answer forward function on your phone, it will send message to the server, and the server will turn on the function immediately. When there are calls to the extension, the server will forward it to the set number automatically based the forward type. And the IP phone will not show the record in the call history anymore.
No Answer CFwd Off Code	Set the No Answer CFwd Off Code, when you choose to disable the busy forward function on your phone, it will send message to the server, and the server will turn off the function immediately.
Ban Anonymous On Code	Set the Ban Anonymous On Code, When you choose to enable the ban anonymous call function on your IP phone, it will send information to the server, and the server will enable the ban anonymous call function for your IP phone automatically.
Ban Anonymous Off Code	Set the Ban Anonymous Off Code, When you choose to disable the ban anonymous call function on your IP phone, it will send information to the server, and the server will disable the ban anonymous call function for your IP phone

	automatically.
Keep Alive Type	Specify the keep alive type, if the type is option, the phone will send option sip message to server every NAT Keep Alive Period(s), then the server responses with 200 to keep alive. If the type is UDP, the phone will send UDP message to server to keep alive every NAT Keep Alive Period(s).
Keep Alive Interval	Set examining interval of the server, default is 60 seconds
User Agent	Set the user agent if have, the default is VoIP Phone 1.0
DTMF Type	Select DTMF sent mode, there are three modes: <ul style="list-style-type: none"> <li>● DTMF_In-band</li> <li>● DTMF_RFC2833</li> <li>● DTMF_SIP_INFO</li> <li>● DTMF_AUTO</li> </ul> Different VoIP Service providers may provide different modes.
DTMF SIP INFO Mode	There are two options: send 10/11 and send * / #
Ring Type	Set ring type of each line
Enable Rport	Enable/Disable system to support RFC3581. Via rport is special way to realize SIP NAT.
Enable PRACK	Enable or disable SIP PRACK function, suggest use the default config.
Enable Long Contact	Set more parameters in contact field; connection with SEM server
Convert URI	Convert # to %23 when send the URI.
Dial Without Registered	Set call out by proxy without registration;
Ban Anonymous Call	Set to ban Anonymous incoming Call;
Enable DNS SRV	Support DNS looking up with _sip. udp mode
Enable Missed Call Log	Enable the missed call log by it, the phone will save the missed call log into the call history record and display the missed calls on the idle screen, or won't save the missed call log into the call history record and display the missed calls on the idle screen.
Enable BLF List	Enable BLF List by selecting it, BLF list is a function which can monitor the group status, it is not one to one monitoring, but the information feedback from the sever to decide which BLF list will monitor
BLF List Number	Specify the BLF List Number
Respond 182 when	when there is a call in call waiting, the phone will

Call waiting	return 182 code
Server Type	Select the special type of server which is encrypted, or has some unique requirements or call flows.
RFC Protocol Edition	Select SIP protocol version to adapt for the SIP server which uses the same version as you select. For example, if the server is CISCO5300, you need to change to RFC2543; else phone may not cancel call normally. System uses RFC3261 as default.
Local Port	Set sip port of each line
RFC Protocol Edition	Set Anonymous call out safely; Support RFC3323and RFC3325;
Keep Authentication	Enable/Disable Keep Authentication System will take the last authentication field which is passed the authentication by server to the request packet. It will decrease the server's repeat authorization work, if it is enable.
Answer With A Single Codec	Enable/Disable the function when call is incoming, phone replies SIP message with just one codec which phone supports.
Auto TCP	Set to use automatically TCP protocol to guarantee usability of transport as message is above 1300 byte
Enable Strict Proxy	Support the special SIP server-when phone receives the packets sent from server, phone will use the source IP address, not the address in via field.
Enable GRUU	Set to support GRUU
Enable Display name Quote	Set to make quotation mark to display name as the phone sends out signal, in order to be compatible with server.
Enable user=phone	Enable user=phone by selecting it, it is contained in the invite sip message, in order to be compatible with server
Click to talk	Set click to Talk (need practical software support).
Transport Protocol	Set transport protocols, TCP or UDP or TLS;
Use VPN	Phone use vpn ip to communicate
Enable DND	When the type of DND feature is line, enable the DND feature for a line
<b>SIP Global Settings</b>	
Strict Branch	Enable the Strict Branch, the value of the branch must be in the beginning of z9hG4k in via field of the invite sip message received, or the phone won't response to the invite sip message. Notice: the deployment will become effective in all sip lines

Enable Group	Enable Group by selecting it, then the phone enable the sip group backup function Notice: the deployment will become effective in all sip lines
Registration Failure Retry Time	Specify the registration failure retry time, if the phone register failed, the phone will register again after registration failure retry time. Notice: the deployment will become effective in all sip lines.

### 8.3.3.2 STUN

In this web page, you can configure SIP STUN.

STUN: By STUN server, the phone in private network could know the type of NAT and the NAT mapping IP and port of SIP. The phone might register itself to SIP server with global IP and port to realize the device both calling and being called in private network.

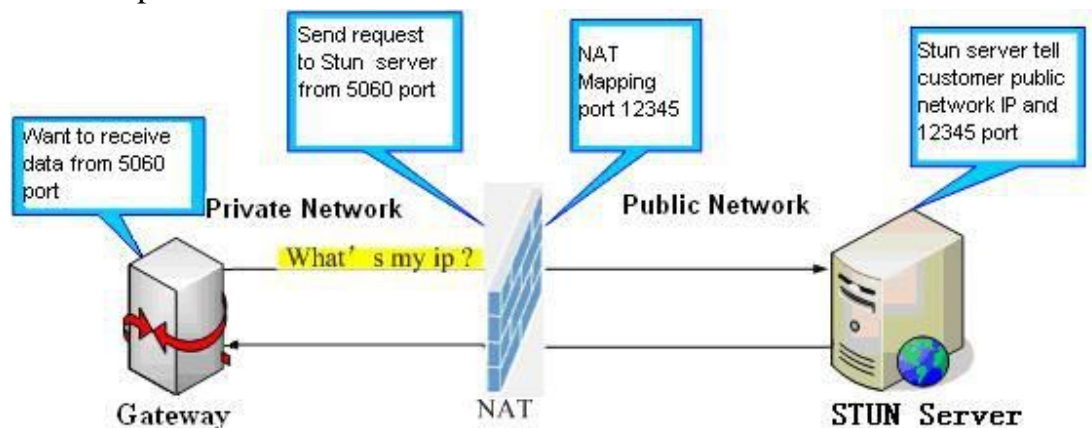

DPH-400GE	BASIC	NETWORK	<b>VOIP</b>	PHONE	MAINTENANCE	SECURITY	LOGOUT
SIP	<b>Simple Traversal of UDP through NATs (STUN) Settings</b>						
<b>STUN</b>	STUN NAT Traversal: <b>FALSE</b> Server Addr: <input type="text"/> Server Port: <input type="text" value="3478"/> Binding Period: <input type="text" value="50"/> second(s) SIP Waiting Time: <input type="text" value="800"/> millisecond(s)						
DIAL PEER	<b>SIP Line Using STUN</b> <input type="text" value="SIP 1"/> <input type="button" value="Load"/>						
	<b>Set Sip Line Enable STUN</b> Use STUN: <input type="checkbox"/> <input type="button" value="Apply"/>						
BROADBAND							

STUN	
Field name	explanation
Simple Traversal of UDP through NATs (STUN) Settings	
STUN NAT Traversal	Shows STUN NAT Transverse estimation, true means STUN can penetrate NAT, while False means not.
Server Address	Set your SIP STUN Server IP address.
Server Port	Set your SIP STUN Server Port.
Blinding Period	Set STUN blinding period(s). If NAT server finds that a NAT mapping is idle after time out, it will release the mapping and the system need send a STUN packet to keep the mapping effective and alive.
SIP Waiting Time	Specify the sip wait stun time; you can input the time depended on your network condition.
<b>Sip Line Using STUN</b>	
<b>SIP Line Using STUN</b> <input type="text" value="SIP 1"/> <input type="button" value="Load"/>	
<b>Set Sip Line Enable STUN</b> Use STUN: <input type="checkbox"/> <input type="button" value="Apply"/>	
Choose line to set info about SIP, There are 4 lines to choose. You can switch by <b>【Load】</b> button.	

Use STUN	Enable/Disable SIP STUN.
<b>Notice:</b> SIP STUN is used to realize SIP penetration to NAT. If your phone configures STUN Server IP and Port (default is 3478), and enable SIP Stun, you can use the ordinary SIP Server to realize penetration to NAT.	

### 8.3.3.3 DIAL PEER

This functionality offers you more flexible dial rule, you can refer to the following content to know how to use this dial rule. When you want to dial an IP address, the entry of IP addresses is very cumbersome, but by this functionality, you can set number 156 to replace 192.168.1.119 here.

Dial Peer Table						
Number	Destination	Port	Mode	Alias	Suffix	Deleted Length
156	192.168.1.119	5060	SIP	no alias	no suffix	0

When you want to dial a long distance call to Beijing, you need dial an area code 010 before local phone number, but you can also dial number 1 instead of 010 after we make a setting according to this dial rule. For example, you want to dial 01062213123, but you need dial only 162213123 to realize your long distance call after you make this setting.

Dial Peer Table						
Number	Destination	Port	Mode	Alias	Suffix	Deleted Length
1T	0.0.0.0	5060	SIP	rep:010	no suffix	1

To save the memory and avoid abundant input of user, add the follow functions:

Dial Peer Table						
Number	Destination	Port	Mode	Alias	Suffix	Deleted Length
13*****	0.0.0.0	5060	SIP	add:0	no suffix	0
13[5-9]*****	0.0.0.0	5060	SIP	add:0	no suffix	0

1.\* Match any single digit that is dialed.

If user makes the above configuration, after user dials 11 digit numbers started with 13, the phone will send out 0 plus the dialed numbers automatically.

2. [] Specifies a range that will match digit. It may be a range, a list of ranges separated by commas, or a list of digits.

If user makes the above configuration, after user dials 11 digit numbers started with from 135 to 139, the phone will send out 0 plus the dialed numbers automatically.

Use this phone you can realize dialing out via different lines without switch in web interface.

DPH-400GE //	BASIC	NETWORK	<b>VOIP</b>	PHONE	MAINTENANCE	SECURITY	LOGOUT
--------------	-------	---------	-------------	-------	-------------	----------	--------

SIP

STUN

**DIAL PEER**

**Dial Peer Table**

Number	Destination	Port	Mode	Alias	Suffix	Deleted Length
156	192.168.1.119	5060	SIP	no alias	no suffix	0
1T	0.0.0.0	5060	SIP	rep:010	no suffix	1
13*****	0.0.0.0	5060	SIP	add:0	no suffix	0
13[5-9]*****	0.0.0.0	5060	SIP	add:0	no suffix	0

**Add Dial Peer**

Phone Number:

Destination (optional):

Port(optional):

Alias(optional):

Call Mode: SIP v

Suffix(optional):

Deleted Length (optional):

**Dial Peer Option**

13[5-9]\*\*\*\*\* v

BROADBAND

## DIAL PEER

Field name	explanation
Phone number	There are two types of matching conditions: one is full matching, the other is prefix matching. In the Full matching, you need input your desired phone number in this blank, and then you need dial the phone number to realize calling to what the phone number is mapped. In the prefix matching, you need input your desired prefix number and T; then dial the prefix and a phone number to realize calling to what your prefix number is mapped. The prefix number supports at most 30 digits.
Destination	Set Destination address. This is optional config item. If you want to set peer to peer call, please input destination IP address or domain name. If you want to use this dial rule on SIP2 line, you need input 255.255.255.255 or 0.0.0.2 in it.SIP3 into 0.0.0.3.
Port	Set the Signal port, the default is 5060 for SIP.
Alias	Set alias. This is optional config item. If you don't set Alias, it will show no alias.
Note: There are four types of aliases.	



- 1) Add: xxx, it means that you need dial xxx in front of phone number, which will reduce dialing number length.
  - 2) All: xxx, it means that xxx will replace some phone number.
  - 3) Del: It means that phone will delete the number with length appointed.
  - 4) Rep: It means that phone will replace the number with length and number appointed.
- You can refer to the following examples of different alias application to know more how to use different aliases and this dial rule.

Call Mode	Select different signal protocol, SIP
Suffix	Set suffix, this is optional config item. It will show no suffix if you don't set it.
Delete Length	Set delete length. This is optional config item. For example: if the delete length is 3, the phone will delete the first 3 digits then send out the rest digits. You can refer to examples of different alias application to know how to set delete length.

**Examples of different alias application**

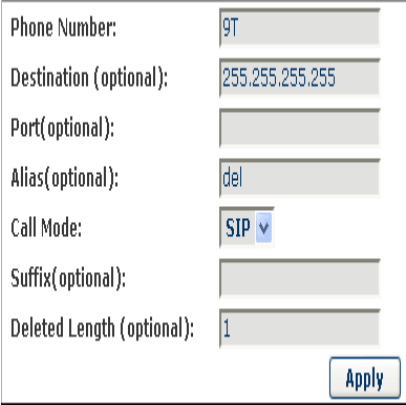
Set by web	explanation	example
	<p>You need set phone number, Destination, Alias and Delete Length. Phone number is XXXT; Destination is 255.255.255.255 (0.0.0.2) and Alias is del. This means any phone No. that starts with your set phone number will be sent via SIP2 line after the first several digits of your dialed phone number are deleted according to delete length.</p>	<p>If you dial "93333", the SIP2 server will receive "3333"</p>

<p>Phone Number: <input type="text" value="2"/></p> <p>Destination (optional): <input type="text"/></p> <p>Port(optional): <input type="text"/></p> <p>Alias(optional): <input type="text" value="all:33334444"/></p> <p>Call Mode: <input type="text" value="SIP"/></p> <p>Suffix(optional): <input type="text"/></p> <p>Deleted Length (optional): <input type="text"/></p> <p style="text-align: right;"><input type="button" value="Apply"/></p>	<p>This setting will realize speed dial function, after you dialing the numeric key “2”, the number after all will be sent out.</p>	<p>When you dial “2”, the SIP1 server will receive 33334444</p>
<p>Phone Number: <input type="text" value="8T"/></p> <p>Destination (optional): <input type="text"/></p> <p>Port(optional): <input type="text"/></p> <p>Alias(optional): <input type="text" value="add:0755"/></p> <p>Call Mode: <input type="text" value="SIP"/></p> <p>Suffix(optional): <input type="text"/></p> <p>Deleted Length (optional): <input type="text"/></p> <p style="text-align: right;"><input type="button" value="Apply"/></p>	<p>The phone will automatically send out alias number adding your dialed number, if your dialed number starts with your set phone number.</p>	<p>When you dial “8309“, the SIP1 server will receive “07558309”</p>
<p>Phone Number: <input type="text" value="010T"/></p> <p>Destination (optional): <input type="text"/></p> <p>Port(optional): <input type="text"/></p> <p>Alias(optional): <input type="text" value="rep:0086"/></p> <p>Call Mode: <input type="text" value="SIP"/></p> <p>Suffix(optional): <input type="text"/></p> <p>Deleted Length (optional): <input type="text" value="3"/></p> <p style="text-align: right;"><input type="button" value="Apply"/></p>	<p>You need set Phone Number, Alias and Delete Length. Phone number is XXXT and Alias is rep: xxx If your dialed phone number starts with your set phone number, the first digits same as your set phone number will be replaced by the alias number specified and New phone number will be send out.</p>	<p>When you dial “0106228”, the SIP1 server will receive “86106228”</p>
<p>Phone Number: <input type="text" value="147"/></p> <p>Destination (optional): <input type="text"/></p> <p>Port(optional): <input type="text"/></p> <p>Alias(optional): <input type="text"/></p> <p>Call Mode: <input type="text" value="SIP"/></p> <p>Suffix(optional): <input type="text" value="0011"/></p> <p>Deleted Length (optional): <input type="text"/></p> <p style="text-align: right;"><input type="button" value="Apply"/></p>	<p>If your dialed phone number starts with your set phone number. The phone will send out your dialed phone number adding suffix number.</p>	<p>When you dial “147”, the SIP1 server will receive “1470011”</p>

## 8.3.4 Phone

### 8.3.4.1 Audio

In this page, you can configure voice codec, input/output volume and so on.

D-Link

DPH-400GE	BASIC	NETWORK	VOIP	PHONE	MAINTENANCE	SECURITY	LOGOUT																																																				
<div style="background-color: #f2f2f2; padding: 2px;">AUDIO</div> <div style="background-color: #f2f2f2; padding: 2px;">FEATURE</div> <div style="background-color: #f2f2f2; padding: 2px;">DIAL PLAN</div> <div style="background-color: #f2f2f2; padding: 2px;">CONTACT</div> <div style="background-color: #f2f2f2; padding: 2px;">REMOTE CONTACT</div> <div style="background-color: #f2f2f2; padding: 2px;">WEB DIAL</div> <div style="background-color: #f2f2f2; padding: 2px;">FUNCTION KEY</div> <div style="background-color: #f2f2f2; padding: 2px;">EXT KEY</div> <div style="background-color: #f2f2f2; padding: 2px;">SOFTKEY</div> <div style="background-color: #f2f2f2; padding: 2px;">MCAST</div> <div style="background-color: #f2f2f2; padding: 2px;">TONE</div> <div style="background-color: #f2f2f2; padding: 2px;">ACTION URL</div>	<div style="background-color: #f2f2f2; padding: 2px; font-weight: bold;">Audio Settings</div> <table style="width: 100%; border-collapse: collapse;"> <tr> <td style="width: 30%;">First Codec:</td> <td style="width: 20%;">G.711A</td> <td style="width: 30%;">Second Codec:</td> <td style="width: 20%;">G.711U</td> </tr> <tr> <td>Third Codec:</td> <td>G.722</td> <td>Fourth Codec:</td> <td>G.729AB</td> </tr> <tr> <td>Fifth Codec:</td> <td>AMR</td> <td>Sixth Codec:</td> <td>G.722</td> </tr> <tr> <td>Seventh Codec:</td> <td>ILBC</td> <td>Eighth Codec:</td> <td>AMR-WB</td> </tr> <tr> <td>Ninth Codec:</td> <td>G.726-32</td> <td>Onhook Time:</td> <td>200 millisecond(s)</td> </tr> <tr> <td>Handset Volume:</td> <td>5 (1~9)</td> <td>Default Ring Type:</td> <td>Type 1</td> </tr> <tr> <td>Speakerphone Volume:</td> <td>5 (1~9)</td> <td>Headset Ring Volume:</td> <td>5 (1~9)</td> </tr> <tr> <td>Headset Volume:</td> <td>5 (1~9)</td> <td>Speakerphone Ring Volume:</td> <td>5 (1~9)</td> </tr> <tr> <td>ILBC Payload Type:</td> <td>97 (96~127)</td> <td>ILBC Payload Length:</td> <td>20ms</td> </tr> <tr> <td>AMR Payload Type:</td> <td>108 (96~127)</td> <td>AMR-WB Payload Type:</td> <td>109 (96~127)</td> </tr> <tr> <td>G.729AB Payload Length:</td> <td>20ms</td> <td>DTMF Payload Type:</td> <td>101 (96~127)</td> </tr> <tr> <td>G.723.1 Bit Rate:</td> <td>6.3kb/s</td> <td>Enable VAD:</td> <td><input type="checkbox"/></td> </tr> <tr> <td>Enable MWI Tone:</td> <td><input checked="" type="checkbox"/></td> <td></td> <td></td> </tr> </table> <p style="text-align: center; margin-top: 10px;"><a href="#" style="border: 1px solid #ccc; padding: 2px 10px; text-decoration: none; color: #000;">Apply</a></p>							First Codec:	G.711A	Second Codec:	G.711U	Third Codec:	G.722	Fourth Codec:	G.729AB	Fifth Codec:	AMR	Sixth Codec:	G.722	Seventh Codec:	ILBC	Eighth Codec:	AMR-WB	Ninth Codec:	G.726-32	Onhook Time:	200 millisecond(s)	Handset Volume:	5 (1~9)	Default Ring Type:	Type 1	Speakerphone Volume:	5 (1~9)	Headset Ring Volume:	5 (1~9)	Headset Volume:	5 (1~9)	Speakerphone Ring Volume:	5 (1~9)	ILBC Payload Type:	97 (96~127)	ILBC Payload Length:	20ms	AMR Payload Type:	108 (96~127)	AMR-WB Payload Type:	109 (96~127)	G.729AB Payload Length:	20ms	DTMF Payload Type:	101 (96~127)	G.723.1 Bit Rate:	6.3kb/s	Enable VAD:	<input type="checkbox"/>	Enable MWI Tone:	<input checked="" type="checkbox"/>		
First Codec:	G.711A	Second Codec:	G.711U																																																								
Third Codec:	G.722	Fourth Codec:	G.729AB																																																								
Fifth Codec:	AMR	Sixth Codec:	G.722																																																								
Seventh Codec:	ILBC	Eighth Codec:	AMR-WB																																																								
Ninth Codec:	G.726-32	Onhook Time:	200 millisecond(s)																																																								
Handset Volume:	5 (1~9)	Default Ring Type:	Type 1																																																								
Speakerphone Volume:	5 (1~9)	Headset Ring Volume:	5 (1~9)																																																								
Headset Volume:	5 (1~9)	Speakerphone Ring Volume:	5 (1~9)																																																								
ILBC Payload Type:	97 (96~127)	ILBC Payload Length:	20ms																																																								
AMR Payload Type:	108 (96~127)	AMR-WB Payload Type:	109 (96~127)																																																								
G.729AB Payload Length:	20ms	DTMF Payload Type:	101 (96~127)																																																								
G.723.1 Bit Rate:	6.3kb/s	Enable VAD:	<input type="checkbox"/>																																																								
Enable MWI Tone:	<input checked="" type="checkbox"/>																																																										
BROADBAND																																																											

<b>DSP Configuration</b>	
<b>Field name</b>	<b>explanation</b>
First Codec	The first preferential DSP codec:G.711A/U,G.722,G.723.1, G.726-32, G.729AB,ILBC,AMR,AMR-WB
Second Codec	The second preferential DSP codec: G.711A/U,G.722,G.723.1, G.726-32, G.729AB,ILBC,AMR,AMR-WB,NONE
Third Codec	The third preferential DSP codec: G.711A/U,G.722,G.723.1, G.726-32 , G.729AB, ILBC,AMR,AMR-WB,NONE
Fourth Codec	The forth preferential DSP codec: G.711A/U,G.722,G.723.1, G.726-32 , G.729AB, ILBC,AMR,AMR-WB,NONE
Fifth Codec	The fifth preferential DSP codec: G.711A/U,G.722,G.723.1, G.726-32, G.729AB,

	ILBC,AMR,AMR-WB,NONE
Sixth codec	The sixth preferential DSP codec: G.711A/U,G.722,G.723.1, G.726-32,G.729AB,ILBC,AMR,AMR-WB,NONE
Seventh Codec	The seventh preferential DSP codec: G.711A/U,G.722,G.723.1, G.726-32, G.729AB,ILBC,AMR,AMR-WB,NONE
Eighth Codec	The eighth preferential DSP codec: G.711A/U,G.722,G.723.1, G.726-32, G.729AB, ILBC,AMR,AMR-WB,NONE
Ninth Codec	The ninth preferential DSP codec: G.711A/U,G.722,G.723.1, G.726-32, G.729AB, ILBC,AMR,AMR-WB,NONE
Onhook Time	Specify the least reflection time of Hand down, the default is 200ms.
Default Ring Type	Select Ring Type
Handset Volume	Specify Handset Volume grade.
Speakerphone volume	Specify Speakerphone Volume grade.
Headset Volume	Specify Headset Volume grade.
Headset Ring Volume	Specify Headset Ring Volume grade
Speakerphone Ring Volume	Specify Speakerphone Ring Volume grade
ILBC Payload Type	Set ILBC payload type
ILBC Payload Length	Set ILBC Payload Length
AMR Payload Type	Set AMR payload type
AMR-WB Payload Type	Set AMR-WB payload type
G729AB Payload Length	Set G729 Payload Length
G723.1 Bit Rate	5.3kb/s or 6.3kb/s is available
DTMF Payload Type	Set DTMF Payload Type.
EnableVAD	Select it or not to enable or disable VAD. If enable VAD, G729 Payload length could not be set over 20ms.
Enable MWI Tone	the phone will play MWI tone when a new MWI comes

## 8.3.4.2 FEATURE

In this web page, you can configure Call Transfer, Call Waiting, 3 Ways Call, Black List, white list Limit List and so on.

**D-Link**

DPH-400GE // BASIC NETWORK VOIP **PHONE** MAINTENANCE SECURITY LOGOUT

AUDIO

**FEATURE**

DIAL PLAN

CONTACT

REMOTE CONTACT

WEB DIAL

FUNCTION KEY

EXT KEY

SOFTKEY

MCAST

STONE

ACTION URL

**Feature Settings**

DND (Do Not Disturb): **Disabled** Push XML Server:

Enable Call Transfer:  DND Return Code: **480(Temporarily Not Available)**

Semi-Attended Transfer:  Busy Return Code: **486(Busy Here)**

Enable Call Waiting:  Reject Return Code: **603(Decline)**

Enable 3-way Conference:  Active URI Limit IP:

Accept Any Call:  Hide DTMF: **Disabled**

Enable Auto Handdown:  Auto Handdown Time: **3** second(s)

Ring From Headset:  Enable Auto Redial:

Enable Silent Mode:  Auto Redial Interval: **10** (1~180)second(s)

Ban Outgoing:  Auto Redial Times: **10** (1~100)

Enable Intercom:  P2P IP Prefix:

Enable Intercom Mute:  Enable Password Dial:

Enable Intercom Tone:  Password Dial Prefix:

Enable Intercom Barge:  Password Length: **0** (0~31)

Turn Off Power Light:  Emergency Call Number: **110**

Enable Call Completion:  Enable Pre-Dial:

Enable Call Waiting Tone:  Auto Headset:

Enable Call History:  Enable Multi Line:

Enable Default Line:  Enable Auto Switch Line:

Allow IP Call:  Play Dialing DTMF Tone:

Play Talking DTMF Tone:

**Apply**

**Block Out Settings**

**Add**  **Delete**

BROADBAND

## FEATURE

Field name	explanation
Do Not Disturb	There are three options: Disabled: The phone accepts any normal incoming call Phone: The phone rejects any incoming call, the caller will automatically prompt hang up, but outgoing calls will not be affected Line: A line enabled DND will reject its any incoming call
Ban Outgoing	If you select Ban Outgoing to enable it, and you cannot dial out any number.

Enable Call Transfer	Enable Call Transfer by selecting it.
Semi-Attended Transfer	Enable Semi-Attended Transfer by selecting it
Enable Auto Handdown	The phone will hang up and return to the idle automatically at hands-free mode
Auto Handdown Time	Specify Auto Hand down Time, the phone will hang up and return to the idle automatically after Auto Hand down Time at hands-free mode, and play dial tone Auto Hand down Time at handset mode
Enable Auto Redial	Enable Auto Redial by selecting it, then the phone reminds whether redial, when the callee is busy or rejects
Auto Redial interval	Specify the Auto Redial interval,
Auto Redial Times	Specify the Auto Redial interval
Auto Headset	Enable the function and put on the headset, when there has a incoming call ,you can press the answer key or line key to answer the call through the headset ,and it's the same if enable auto answer function
Enable Intercom	Enable Intercom Mode by selecting it
Enable Intercom Mute	Enable mute mode during the intercom call
Enable Intercom Tone	If the incoming call is intercom call, the phone plays the intercom tone
Enable Intercom Barge	Enable Intercom Barge by selecting it, the phone auto answers the intercom call during a call. If the current call is intercom call, the phone will reject the second intercom call
P2P IP Prefix	Set Prefix in peer to peer IP call. For example: what you want to dial is 192.168.1.119, If you define P2P IP Prefix as 192.168.1., you dial only #119 to reach 192.168.1.119. Default is “.”. If there is no “.” Set, it means to disable dialing IP.
Turn Off Power Light	Enable Turn Off Power Light by selecting it
Emergency Call Number	Specify the Emergency Call Number. Despite the keyboard is locked ,you can dial the emergency call number
Enable Password Dial	Enable Password Dial by selecting it, When number entered is beginning with the password prefix, the following N numbers after the password prefix will be hidden as *, N stand for the value which you enter in the Password Length field. For example: you set the password prefix is 3, enter

	the Password Length is 2, then you enter the number 34567, it will display 3**67 on the phone
Password Dial Prefix	Specify the prefix of the password call number
Password Length	Specify the Password length
Enable Call Waiting	Enable Call Waiting by selecting it. then the phone reminds whether redial, when the caller is busy or rejects . if it's ok and the phone finds out that the caller is idle by sip message, it will reminds whether redial
Enable 3-way Conference	Enable 3-way conference by selecting it
Accept Any Call	If select it, the phone will accept the call even if the called number is IP .
Enable Call Completion	Enable Call Completion by selecting it, If the callee is busy, the sip server will inspect the callee status at intervals. If the callee is idle, the server will send notify message to inform the caller whether redial.
Enable Pre-dial	Disable this feature, in standby interface next number, will realize the number rules "send out over the time";Enable the feature ,then the number will not be send out over the time.
Enable Silent Mode	Enable Silent Mode by selecting it, the phone light will red blink to remind that there is a missed call instead of playing ring tone
Hide DTMF	Specify the hide DTMF mode
Ring From Headset	Enable Ring From Handset by selecting it, the phone plays ring tone from handset
DND Return Code	Specify DND Return code
Busy Return Code	Specify Busy Return Code
Reject Return Code	Specify Reject Return Code
Active URI Limit IP	Specify the server IP that remote control phone for corresponding operation
Push XML Server	Specify the Push XML Server, when phone receives request, it will determine whether to display corresponding content on the phone which sent by the specified server or not.
Enable Call Waiting Tone	Turn off this feature, you will not hear issued a " beep" sound with more calls
Enable Call History	You can see the phone call history
Enable Multi	Enable multi-line,10 road calls can be enabled, otherwise make

Line	at most two road calls
Enable Default Line	When enabled, a sip line becomes the default line; disabled, the phone will begin in accordance with the line from the SIP1 sequential search, select an available line for calls.
Enable Auto Switch Line	Prerequisite: Enable Default Line ON: If sip1 registration fails, it will automatically find the first available line down Off: If sip1 registration fails, does not automatically find the first available down the line, using the default line If default Line is disabled, automatic line switch function does not take effect
Allow IP Call	Enter the remote IP to make a call
Play Talking DTMF Tone	Press the number keys in a call, you can hear the sound of the end
Play Dialing tone	Press the number keys in dialing, you can hear the sound of the end
<b>Block Out Settings</b>	
Block out	Set Add/Delete Limit List. Please input the prefix of those phone numbers which you forbid the phone to dial out. For example, if you want to forbid those phones of 001 as prefix to be dialed out, you need input 001 in the blank of limit list, and then you cannot dial out any phone number whose prefix is 001. X and are wildcard x means matching any single digit. For example, 4xxx expresses any number with prefix 4 which length is 4 will be forbidden to dialed out means matching any arbitrary number digit. For example, 6 expresses any number with prefix 6 will be forbidden to dialed out.
Notice: Black List and Limit List can record at most 10 items respectively.	

### 8.3.4.3 DIAL PLAN

This system supports 4 dial modes:

- 1) End with “#”: dial your desired number, and then press #.
- 2) Fixed Length: the phone will intersect the number according to your specified length.
- 3) Time Out: After you stop dialing and waiting time out, system will send the number collected.
- 4) Press # to Do Blind Transfer: input the number you want to transfer to then press “#” you can transfer the current call to the number.
- 5) Blind Transfer on OnHook : input the number you want to transfer to then



- hang up handle or press speaker, you can transfer the current call to the number.
- 6) Attend Transfer on OnHook: hang up handle or press speaker you can realize the blind transfer function.
  - 7) Press DSS Key to Do Blind Transfer: press dss-key, the phone will transfer the current call to the third party
  - 8) User defined: you can customize digital map rules to make dialing more flexible. It is realized by defining the prefix of phone number and number length of dialing.

In order to keep some users' secondary dialing manner when dialing the external line with PBX, phone can be added a special rule to realize it. so user can dial a number as external line prefix and get the secondary dial tone to keep dial the external number. After finishing dialing, phone will send the prefix and external number totally to the server.

For example, there is a rule 9, xxxxxxxx in the digital map table. After dialing 9, phone will send the secondary dial tone, user may keep going dialing. After finished, phone will call the number which starts with 9; actually the number sent out is 9-digit with 9.

<b>DIAL PLAN Configuration</b>	
<b>Field name</b>	<b>explanation</b>
<b>Basic Setting</b>	
Press "#" to Send	Set Enable/Disable the phone ended with “#” dial.
Dial Fixed Length	Specify the Fixed Length of phone ending with.
Send after (3-30)	Set the timeout of the last dial digit. The call will be sent after timeout.

seconds	
Press # to Do Blind Transfer	Enable Blind Transfer On Hook, when executing Blind Transfer End with #, press # after inputting the number that you want to transfer, the phone will transfer the current call to the third party
Blind Transfer on OnHook	Enable Blind Transfer on On Hook, when executing Blind Transfer, hang up after inputting the number that you want to transfer, the phone will transfer the current call to the third party
Attend Transfer on OnHook	Enable Attend Transfer on On Hook, when executing Attended Transfer, hang up after the third party answers, the phone will transfer the current call to the third party
Press DSS Key to Do Blind Transfer	Enable press DSS Key to Do Blind Transfer, when executing Blind Transfer, press dss-key, the phone will transfer the current call to the third party

#### Dial Plan Table

Plans:

Add
▼
Delete

Below is user-defined digital map rule:  
 [] Specifies a range that will match digit. May be a range, a list of ranges separated by commas, or a list of digits.  
 \* Match any single digit that is dialed.  
 . Match any arbitrary number of digits including none.  
 Tn Indicates an additional time out period before digits are sent of n seconds in length. n is mandatory and can have a value of 0 to 9 seconds. Tn must be the last 2 characters of a dial plan. If Tn is not specified it is assumed to be T0 by default on all dial plans.

Plans:  
 "[1-8]xxx"  
 "9xxxxxxxx"  
 "911"  
 "99T4"  
 "9911x.t4"

Cause extensions 1000-8999 to be dialed immediately  
 Cause 8 digit numbers started with 9 to be dialed immediately  
 Cause 911 to be dialed immediately after it is entered.  
 Cause 99 to be dialed after 4 seconds.  
 Cause any number started with 9911 to be dialed 4 seconds after dialing ceases.

**Notice:** Dial plan can realised at speaker,pick handle or headset mode. End with “#”, Fixed Length, Time out and Digital Map Table can be used simultaneously, System will stop dialing and send number according

to your set rules.

### 8.3.4.4 CONTACT

You can input the name, phone number and select ring type for each name here.

**D-Link**

DPH-400GE // BASIC NETWORK VOIP PHONE MAINTENANCE SECURITY LOGOUT

AUDIO  
FEATURE  
DIAL PLAN  
**CONTACT**  
REMOTE CONTACT  
WEB DIAL  
FUNCTION KEY  
EXT KEY  
SOFTKEY  
MCAST  
TONE  
ACTION URL

**Phonebook Table**

Group: All [Hangup](#)

Index	Name	Office Number	Mobile Number	Other Number	Ring Type	Group
Page: [v]	[Pre] [Next]	friend [v]	[Add] [i]	[Add to Blacklist]	[Delete]	[Delete All]

**Add Contact**

Name: [ ] Ring Type: Default [v]  
 Office Number: [ ] Line: Auto [v]  
 Mobile Number: [ ] Line: Auto [v]  
 Other Number: [ ] Line: Auto [v]

Group Setting: Unselected Selected

friend home work business classmate [v] [->] [->] [Clear]

[Add] [Modify]

**Import Contact List**

Select File: [ ] [Browse] (\*.xml,\*.vcf,\*.csv) [Update]

**Export Contact List**

[Export XML] [Export CSV] [Export VCF]

**Group Option**

Group: friend [v]  
 Name: friend [ ]  
 Ring Type: Default [v]  
 [Add] [Modify] [Delete] [Delete All]

**Blacklist Settings**

Blacklist Item: [v] [Delete] [Delete All]

Type: Number [v]  
 Value: [ ] [Add]  
 Line: Auto [v]

Blacklist

BROADBAND

## CONTACT

**Field name**

**explanation**

<b>Phonebook Table</b>						
Group: <input type="text" value="All"/> <span style="float: right;"><a href="#">Hangup</a></span>						
Index	Name	Office Number	Mobile Number	Other Number	Ring Type	Group
Name	Shows the name corresponding to the phone number					
Number	Shows the phone number					
Ring Type	Shows the ring type of the incoming call.					
Group	Shows the group of the contact					
Notice: the maximum capability of the phonebook is 500 items, you can select many or a contact to add to group and add to blacklist, and delete many or a contact, and delete all contacts.						
<b>Add Contact List</b>						
Name	Specify the name corresponding to the phone number					
Office Number	Specify the office number					
Mobile Number	Specify the mobile number					
Other Number	Specify the other number					
Ring Type	Specify the ring type for the phone number					
Line	Specify the sip line for the each number					
Group setting	Select the group from the unselected group to selected list for the contact; you can select many groups for the contact.					
Notice: the add button for adding a new contact, the modify button for modifying the added contact, the clear all button for clear all input information of the contact						
<b>Group Option</b>						
Group	Select the added groups, then modify or delete and so on					
Name	Input the name of the group, then click the add button, you can add a new group.					
Ring Type	Specify the ring type for the group as adding a new group					
<b>Import Contact List</b>						
Select File	Click the browse button to select the phonebook file that you want to import, than click update button, the phonebook file selected will be added to the phone.					
<b>Export Contact File</b>						
Export XML	Click export xml button to export phonebook file of xml model					
Export CSV	Click export xml button to export phonebook file of csv model					
Export VCF	Click export xml button to export phonebook file of					

	vcf model
<b>Blacklist Settings</b>	
Type	Select the blacklist type, you can select number or prefix of number
Value	Input number or prefix of number
Line	Select the sip line
<p>Notice: the add button for adding a new blacklist, the delete button for deleting one item, the delete all button for deleting all items.</p> <p>If user does not want to answer some phone calls, add these phone numbers to the Black List, and these calls will be rejected.x and are wildcard x means matching any single digit. for example, 4xxx expresses any number with prefix 4 which length is 4 will be forbidden to be responded.</p> <p>DOT (.) means matching any arbitrary number digit. for example, 6. expresses any number with prefix 6 will be forbidden to be responded.</p> <p>If user wants to allow a number or a series of number incoming, he may add the number(s) to the list as the white list rule. the configuration rule is -number, for example, -123456, or -1234xx</p>	
<b>Blacklist</b>	
4149	
Means any incoming number is forbidden except for 4119 Note: End with DOT (.) when set up the white list	

## 8.3.4.5 REMOTE CONTACT

The screenshot shows the D-Link web interface for the DPH-400GE device. The 'PHONE' tab is selected, and the 'REMOTE CONTACT' option is highlighted in the left sidebar. The main content area is divided into two sections: 'Remote Phonebook Settings' and 'LDAP Settings'.

**Remote Phonebook Settings:** This section contains a table with 4 rows. Each row has columns for 'Index', 'Phonebook Name', 'Server URL', 'SIP Line', 'User', and 'Password'. The 'SIP Line' column has a dropdown menu set to 'AUTO'. An 'Apply' button is located below the table.

**LDAP Settings:** This section is titled 'LDAP Settings' with a dropdown menu set to 'LDAP 1'. It contains several fields: 'Display Title', 'Server Address', 'Authentication' (dropdown set to 'None'), 'Username', 'Search Base', 'Telephone' (set to 'telephoneNumber'), 'Other' (set to 'home'), 'Version' (dropdown set to 'Version 3'), 'Server Port' (set to '389'), 'Line' (dropdown set to 'AUTO'), 'Password', 'Enable Calling Search' (checkbox), 'Mobile' (set to 'mobile'), and 'Display Name' (set to 'cn'). An 'Apply' button is located at the bottom.

You need to match a XML Phonebook address and you can directly access to the corresponding remote phonebook on the phone.

Remote Phonebook Setting	
Phonebook Name	Custom the phonebook name displayed on the phone
Server URL	Specify the server url of the remote phonebook
Sip Line	Specify the sip line for the remote phonebook
Authentication	Specify the authentication mode for remote phonebook
Username/password	Input the authentication username and password

(Note: remote book support the modes as HTTP ,FTP ,TFTP)

LDAP Settings	
Display Title	LDAP phonebook name
Version	LDAP version
Server Address	LDAP server address
Server port	LDAP server port

Authentication	There are four options: NONE, DIGEST-MD5, CRAM-MD5, Simple
Line	contacts call using the selected line
Username	Enter username
Password	Enter password
Search Base	query the root directory access to LDAP
Enable Calling Search	the phone search LDAP server in the outgoing / incoming call . If a contact is searched, its name will be displayed on the screen
Telephone	Contacts' telephone
Mobile	Contacts' mobile phone
Other	Contacts' other information
Display Name	Contacts' displayname

### 8.3.4.6 WEB DIAL

You can make a call through the WEB DIAL, enter the Dial Num then press Dial, if you want to finish the talk, press Hang-up.

### 8.3.4.7 MCAST

**D-Link**

DPH-400GE // BASIC NETWORK VOIP **PHONE** MAINTENANCE SECURITY LOGOUT

AUDIO  
FEATURE  
DIAL PLAN  
CONTACT  
REMOTE CONTACT  
WEB DIAL  
FUNCTION KEY  
EXT KEY  
SOFTKEY  
**MCAST**  
TONE  
ACTION URL

**MCAST Settings**

Priority: 1

Enable Page Priority:

Index/Priority	Name	Host:port
1		
2		
3		
4		
5		
6		
7		
8		
9		
10		

Apply

BROADBAND

Use the multicast function to send notice to every member of the multicast is simple and easy. By setting the multicast key on your phone, you can send multicast RTP flow to the pre-configured multicast address. By listening multicast address is configured on the phone, listen and play the multicast address to send the RTP stream.

#### Send multicast setting

On the phone web page,function key-function key,set a function key, as shown

DSS Key 8 Multicast 239.1.1.1:1366 AUTO G.711A

Value format IP:Port, the IP address of multicast is range from 224.0.0.0 to 239.255.255.255,port is greater than 1024

If multicast codec is G722, the LCD screen will displays "HD", which means the phone is sending high-definition voice stream

Operate steps:

1、 When the phone is idle, press multicast key

Multicast RTP stream is sended to pre-configured multicast address (IP: Port)。 The phone which listens to multicast address in the local network can



receive the RTP stream. Multicast functionkey LED lights yellow.  
LCD screen displays the following:



- 2、 Press the hold softkey to hold the current multicast session
- 3、 Press the end softkey again or multicast functionkey, multicast session can be stopped

Notice: RTP stream is one side, that is from a sender to a receiver. when the phone initiates a multicast RTP session in a call,the current call is on hold.

### **Receive multicast setting**

You can set up the phone monitoring 10 different multicast addresses to receive these multicast RTP stream.

You have two method to receive RTP stream of multicast that can be set up through the web page: Enable priorities of normal calls and Enable page Priority:

Enable priorities of normal call by select it, if the incoming RTP stream priority of multicast lower than the priority of current for normal calls, the phone will ignore the RTP stream of multicast. If the incoming RTP stream priority of multicast higher than the priority of current for normal calls, the phone will receive the RTP stream of multicast, and hold the current call.

Disabled priorities of normal call by select disable, the phone will ignore all local network RTP stream of multicast.

Options as follows:

1-10:the priority defined for normal calls,1 the highest level,10 the lowest level

Disabled: Ignore all RTP stream of multicast

### **Enable Page Priority**

Page priority determines the phone how to handle the newly received multicast RTP stream when in a multicast session. Enabled page priority, the phone will automatically ignore the low priority multicast RTP stream and receive the high priority multicast RTP stream and hold the current multicast session; If not enabled, the phone will automatically ignore all incoming multicast RTP stream.

Web page is set as follows:

## MCAST Settings

Priority:

Enable Page Priority:

Index/Priority	Name	Host:port
1	ss	239.1.1.1:1366
2	ee	239.1.1.1:1367

Now multicast ss has higher priority than multicast ee, the highest priority is for normal calls

Notice: When a multicast session begins, multicast sender and receiver will beep

### 8.3.4.8 TONE

**D-Link**

DPH-400GE / BASIC NETWORK VOIP **PHONE** MAINTENANCE SECURITY LOGOUT

AUDIO  
FEATURE  
DIAL PLAN  
CONTACT  
REMOTE CONTACT  
WEB DIAL  
FUNCTION KEY  
EXT KEY  
SOFTKEY  
MCAST  
**TONE**  
ACTION URL

### Tone Settings

Tone Standard:

Dial Tone:

Ring Back Tone:

Busy Tone:

Congestion Tone:

Call waiting Tone:

Holding Tone:

Error Tone:

Stutter Tone:

Information Tone:

Dial Recall Tone:

Measage Tone:

Howler Tone:

Number Unobtainable Tone:

Warning Tone:

Record Tone:

Auto Answer Tone:

BROADBAND

You can select the desired tone standard, also can customize the settings

### 8.3.4.9 Action URL

DPH-400GE //	BASIC	NETWORK	VOIP	PHONE	MAINTENANCE	SECURITY	LOGOUT	
AUDIO	<b>Action URL Settings</b>							
FEATURE	Setup Completed:	<input type="text"/>						
DIAL PLAN	Registration Success:	<input type="text"/>						
CONTACT	Registration Disabled:	<input type="text"/>						
REMOTE CONTACT	Registration Failed:	<input type="text"/>						
WEB DIAL	Off Hook:	<input type="text"/>						
FUNCTION KEY	On Hook:	<input type="text"/>						
EXT KEY	Incoming Call	<input type="text"/>						
SOFTKEY	Outgoing Call:	<input type="text"/>						
MCAST	Call Established:	<input type="text"/>						
TONE	Call Terminated:	<input type="text"/>						
<b>ACTION URL</b>	DND Enabled:	<input type="text"/>						
	DND Disabled:	<input type="text"/>						
	Always Forward Enabled:	<input type="text"/>						
	Always Forward Disabled:	<input type="text"/>						
	Busy Forward Enabled:	<input type="text"/>						
	Busy Forward Disabled:	<input type="text"/>						
	No Ans. Forward Enabled:	<input type="text"/>						
	No Ans. Forward Disabled:	<input type="text"/>						
	Transfer Call:	<input type="text"/>						
	Blind Transfer Call:	<input type="text"/>						
	Attended Transfer Call:	<input type="text"/>						
	Hold:	<input type="text"/>						
	Resume:	<input type="text"/>						
	Mute:	<input type="text"/>						
	Unmute:	<input type="text"/>						
	Missed Call:	<input type="text"/>						
	IP Changed:	<input type="text"/>						
	Idle To Busy:	<input type="text"/>						
	Busy To Idle:	<input type="text"/>						
					<input type="button" value="Apply"/>			

Specify the Action URL that Record the operation of phone, send these corresponding information to server, url:http://InternalServer/FileName.xml?(Internal Server is server ip, FileName is name of xml that contains the action message )

## 8.3.5 Function Key



<b>DPH-400GE</b>	BASIC	NETWORK	VOIP	PHONE	MAINTENANCE	SECURITY	LOGOUT
------------------	-------	---------	------	-------	-------------	----------	--------

AUDIO FEATURE DIAL PLAN CONTACT REMOTE CONTACT WEB DIAL <b>FUNCTION KEY</b> EXT KEY SOFTKEY MCAST TONE ACTION URL	<h3 style="background-color: #333; color: white; padding: 2px;">Screen Configuration</h3> Contrast: <input style="width: 50px;" type="text" value="5"/> (1~9)      Enable Backlight: <input checked="" type="checkbox"/> Backlight Time: <input style="width: 50px;" type="text" value="30"/> <div style="text-align: right; margin-top: 5px;"><a href="#">Apply</a></div>
--	--

Function Key Settings						
Key	Type	Value	Line	Subtype	Pickup Number	
DSS Key 1	Line		SIP1	None		
DSS Key 2	Line		SIP2	None		
DSS Key 3	Line		SIP3	None		
DSS Key 4	Line		SIP4	None		
DSS Key 5	Line		SIP5	None		
DSS Key 6	Key Event		AUTO	MWI		
DSS Key 7	Key Event		AUTO	Headset		
DSS Key 8	Key Event		AUTO	Release		

[Apply](#)

Programmable Key Settings				
Key	Desktop	Dialer	Calling	Desktop Long Pressed
Up	History	Prev. Line	Prev. Call	Status
Down	Status	Next Line	Next Call	None
Left	Pre Account	None	Volume Down	None
Right	Next Account	None	Volume Up	Speed Dial
OK	Menu	None	None	None

[Apply](#)

BROADBAND

### 8.3.5.1 Function Key

Field name	explanation
Contrast	Set contrast of screen
Enable Backlight	Set enable/disable backlight
Backlight Time	You don't operate the phone more than a backlight timeout setting, the backlight will turn off automatically
<b>Line Key Settings</b>	
<b>Line:</b> select Auto, SIP1, SIP2, SIP3, SIP4, or IAX2 in function key type. After you set it, you pick up handset or hands-free, press this function key, and then you can use the corresponding SIP line.	

**Function Key Settings**

key	Show the function key's serial number
Type	Memory Key: settings can be stored in key storage for each number, the standby or off-hook, select the function keys on the keyboard can call this number. Line, set the dial mode (Auto, SIP1, SIP2, SIP3, SIP4, IAX2).Key Key Event functions, monitor state. DTMF: In the call, send DTMF URL: You can input remote book url
Value	Set the type parameter values.
Line	Choose which lines to use this feature.
Subtype	Select the function parameters Key Event and Memory Event.
Pickup Number	The value of SubType is the number to BLF or Presence.

**NOTICE:**

- memory keys can be configured through the following: **Speed Dial function**, through the configuration of the key corresponding to the number of ways as shown below.



User can press the F1 key to allocate this number by line1 line.

- **Intercom function**, you can press this key in standby to automatically answer the call and make each other.



User can be configured in accordance with push to talk function the way: 4116 was the other number; Then press the standby button and make it automatically answer the call 4116.

- key can be configured through the following events:  
For example:

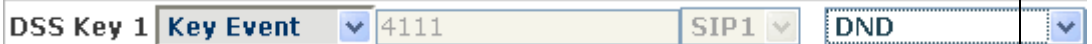

### 8.3.5.2 EXT KEY

DPH-400GE	BASIC	NETWORK	VOIP	PHONE	MAINTENANCE	SECURITY	LOGOUT																																																																																																																																																																		
AUDIO	Expansion Module Selection																																																																																																																																																																								
FEATURE	Expansion Module 1		Load	Not Connected																																																																																																																																																																					
DIAL PLAN	<table border="1"> <thead> <tr> <th>Key</th> <th>Type</th> <th>Value</th> <th>Line</th> <th>Subtype</th> <th>Pickup Number</th> </tr> </thead> <tbody> <tr><td>F 1</td><td>None</td><td></td><td>AUTO</td><td>None</td><td></td></tr> <tr><td>F 2</td><td>None</td><td></td><td>AUTO</td><td>None</td><td></td></tr> <tr><td>F 3</td><td>None</td><td></td><td>AUTO</td><td>None</td><td></td></tr> <tr><td>F 4</td><td>None</td><td></td><td>AUTO</td><td>None</td><td></td></tr> <tr><td>F 5</td><td>None</td><td></td><td>AUTO</td><td>None</td><td></td></tr> <tr><td>F 6</td><td>None</td><td></td><td>AUTO</td><td>None</td><td></td></tr> <tr><td>F 7</td><td>None</td><td></td><td>AUTO</td><td>None</td><td></td></tr> <tr><td>F 8</td><td>None</td><td></td><td>AUTO</td><td>None</td><td></td></tr> <tr><td>F 9</td><td>None</td><td></td><td>AUTO</td><td>None</td><td></td></tr> <tr><td>F 10</td><td>None</td><td></td><td>AUTO</td><td>None</td><td></td></tr> <tr><td>F 11</td><td>None</td><td></td><td>AUTO</td><td>None</td><td></td></tr> <tr><td>F 12</td><td>None</td><td></td><td>AUTO</td><td>None</td><td></td></tr> <tr><td>F 13</td><td>None</td><td></td><td>AUTO</td><td>None</td><td></td></tr> <tr><td>F 14</td><td>None</td><td></td><td>AUTO</td><td>None</td><td></td></tr> <tr><td>F 15</td><td>None</td><td></td><td>AUTO</td><td>None</td><td></td></tr> <tr><td>F 16</td><td>None</td><td></td><td>AUTO</td><td>None</td><td></td></tr> <tr><td>F 17</td><td>None</td><td></td><td>AUTO</td><td>None</td><td></td></tr> <tr><td>F 18</td><td>None</td><td></td><td>AUTO</td><td>None</td><td></td></tr> <tr><td>F 19</td><td>None</td><td></td><td>AUTO</td><td>None</td><td></td></tr> <tr><td>F 20</td><td>None</td><td></td><td>AUTO</td><td>None</td><td></td></tr> <tr><td>F 21</td><td>None</td><td></td><td>AUTO</td><td>None</td><td></td></tr> <tr><td>F 22</td><td>None</td><td></td><td>AUTO</td><td>None</td><td></td></tr> <tr><td>F 23</td><td>None</td><td></td><td>AUTO</td><td>None</td><td></td></tr> <tr><td>F 24</td><td>None</td><td></td><td>AUTO</td><td>None</td><td></td></tr> <tr><td>F 25</td><td>None</td><td></td><td>AUTO</td><td>None</td><td></td></tr> <tr><td>F 26</td><td>None</td><td></td><td>AUTO</td><td>None</td><td></td></tr> </tbody> </table>							Key	Type	Value	Line	Subtype	Pickup Number	F 1	None		AUTO	None		F 2	None		AUTO	None		F 3	None		AUTO	None		F 4	None		AUTO	None		F 5	None		AUTO	None		F 6	None		AUTO	None		F 7	None		AUTO	None		F 8	None		AUTO	None		F 9	None		AUTO	None		F 10	None		AUTO	None		F 11	None		AUTO	None		F 12	None		AUTO	None		F 13	None		AUTO	None		F 14	None		AUTO	None		F 15	None		AUTO	None		F 16	None		AUTO	None		F 17	None		AUTO	None		F 18	None		AUTO	None		F 19	None		AUTO	None		F 20	None		AUTO	None		F 21	None		AUTO	None		F 22	None		AUTO	None		F 23	None		AUTO	None		F 24	None		AUTO	None		F 25	None		AUTO	None		F 26	None		AUTO	None	
Key	Type	Value	Line	Subtype	Pickup Number																																																																																																																																																																				
F 1	None		AUTO	None																																																																																																																																																																					
F 2	None		AUTO	None																																																																																																																																																																					
F 3	None		AUTO	None																																																																																																																																																																					
F 4	None		AUTO	None																																																																																																																																																																					
F 5	None		AUTO	None																																																																																																																																																																					
F 6	None		AUTO	None																																																																																																																																																																					
F 7	None		AUTO	None																																																																																																																																																																					
F 8	None		AUTO	None																																																																																																																																																																					
F 9	None		AUTO	None																																																																																																																																																																					
F 10	None		AUTO	None																																																																																																																																																																					
F 11	None		AUTO	None																																																																																																																																																																					
F 12	None		AUTO	None																																																																																																																																																																					
F 13	None		AUTO	None																																																																																																																																																																					
F 14	None		AUTO	None																																																																																																																																																																					
F 15	None		AUTO	None																																																																																																																																																																					
F 16	None		AUTO	None																																																																																																																																																																					
F 17	None		AUTO	None																																																																																																																																																																					
F 18	None		AUTO	None																																																																																																																																																																					
F 19	None		AUTO	None																																																																																																																																																																					
F 20	None		AUTO	None																																																																																																																																																																					
F 21	None		AUTO	None																																																																																																																																																																					
F 22	None		AUTO	None																																																																																																																																																																					
F 23	None		AUTO	None																																																																																																																																																																					
F 24	None		AUTO	None																																																																																																																																																																					
F 25	None		AUTO	None																																																																																																																																																																					
F 26	None		AUTO	None																																																																																																																																																																					
CONTACT	Apply																																																																																																																																																																								
REMOTE CONTACT																																																																																																																																																																									
WEB DIAL																																																																																																																																																																									
FUNCTION KEY																																																																																																																																																																									
EXT KEY																																																																																																																																																																									
SOFTKEY																																																																																																																																																																									
MCAST																																																																																																																																																																									
STONE																																																																																																																																																																									
ACTION URL																																																																																																																																																																									

**EXT KEY** has the same usage with the Function key. “In” port connects the phone, “Out” port connects the next one, if there is only, you don’t need for power supply, if there are more than one, you need supply 5V power for the first one, and use RJ-45 direct connector.

### 8.3.5.3 SOFTKEY

**D-Link**

DPH-400GE // BASIC NETWORK VOIP **PHONE** MAINTENANCE SECURITY LOGOUT

**Softkey Settings**

Softkey Mode: More

Screen: Call Dialer

Unselected Softkeys	Selected Softkeys
None	Delete
Call Back (CBack)	None
Clear	Dial
History	Exit
In	
Join	
Missed	
MWI	
Next Line (Next)	
Out	
Pause	
Phonebook (Dir)	
Pickup	
Prev. Line (Prev.)	
Redial	

Apply

BROADBAND

You can configure different functions in different screens for every softkey.

### 8.3.6 Maintenance

#### 8.3.6.1 Auto Provision

**D-Link**

DPH-400GE // BASIC NETWORK VOIP PHONE **MAINTENANCE** SECURITY LOGOUT

**Auto Provision Settings**

Current Config Version: 2.0002

Common Config Version: 2.0002

CPE Serial Number: 00100400XH020010000000010e597052

User:

Password:

Config Encryption Key:

Common Config Encryption Key:

Save Autoprovision Information:

**DHCP Option Settings >>**

DHCP Option Setting: DHCP Option 66

Custom DHCP Option: 66 (128~254)

**Plug and Play (PnP) Settings >>**

Enable PnP:	<input checked="" type="checkbox"/>
PnP Server:	<input type="text" value="224.0.1.75"/>
PnP Port:	<input type="text" value="5060"/>
PnP Transport:	<input type="text" value="UDP"/>
PnP Interval:	<input type="text" value="1"/> hour(s)

**Phone Flash Settings >>**

Server Address:	<input type="text" value="0.0.0.0"/>
Config File Name:	<input type="text"/>
Protocol Type:	<input type="text" value="FTP"/>
Update Interval:	<input type="text" value="1"/> hour(s)
Update Mode:	<input type="text" value="Disabled"/>

**TR069 Settings >>**

Enable TR069:	<input type="checkbox"/>
ACS Server Type:	<input type="text" value="Common"/>
ACS Server URL:	<input type="text" value="0.0.0.0"/>
ACS User:	<input type="text" value="admin"/>
ACS Password:	<input type="password" value="....."/>
TR069 Auto Login:	<input type="checkbox"/>
"Inform" Sending Period:	<input type="text" value="3600"/> second(s)

BROADBAND

Fanvil endpoint supports PnP and DHCP and Phone Flash to obtain the parameters. The PnP and DHCP and Phone Flash are all deployed, endpoint will go by the following process to try to obtain the server address and other parameters, when it boots up:

DHCP option → PnP server → Phone Flash

<b>Auto Provision</b>	
<b>Field name</b>	<b>explanation</b>
<b>Auto Update Setting</b>	
Current Config Version	Show the current config file's version. If the version of the configuration downloaded is higher than the version of the running configurations, the auto provision would upgrade, or stop here. If the endpoints confirm the configuration by Digest method, the endpoints wouldn't upgrade configuration unless the configuration in the server is different with the running configuration.
Common Config Version	Show the common config file's version. If the configuration downloaded and the running



	configurations are the same, the auto provision would stop here. If the endpoints confirm the configuration by Digest method, the endpoints wouldn't upgrade configuration unless the configuration in the server is different with the running configuration.
CPE Serial Number	Show CPE Serial Number
User	Specify FTP/HTTP/HTTPS server Username. System will use anonymous if username keep blank.
Password	Specify FTP/HTTP/HTTPS server Password.
Config Encrypt Key	Input the Encrypt Key, if the configuration file is encrypted.
Common Config Encrypt Key	Input the Common Encrypt Key, if the Common Configuration file is encrypted
Save Autoprovision Information	Save the username and password authentication message of http/https/ftp and input ID message in the phone until the URL in the server changes
<b>DHCP Option Setting</b>	
DHCP Option Setting	Specify DHCP Option. DHCP option supports DHCP custom option and DHCP option 66 and DHCP option 43 to obtain the parameters. You could choose one method among them, the default is DHCP option disable.
Custom DHCP Option	A valid Custom DHCP Option is from 128 to 254. The Custom DHCP Option must be in accordance with the one defined in the DHCP server.
<b>Plug and Play</b>	
Enable PnP	Enable PnP by selecting it, than the phone will send SIP SUBSCRIBE messages to a multicast address when it boots up. Any SIP server understanding that message will reply with a SIP NOTIFY message containing the Auto Provisioning Server URL where the phones can request their configuration.
PnP Server	Specify the PnP Server
PnP Port	Specify the PnP Server
PnP Transport	Specify the PnP Transfer protocol
PnP Interval	Specify the Interval time, unit is hour
<b>Phone Flash</b>	
Server Address	Set FTP/TFTP/HTTP/HTTPS server IP address for auto update. The address can be IP address or Domain name with subdirectory.
Config File Name	Set configuration file's name which need to update. System will use MAC as config file name if config file

	name keep blank. For example, 000102030405.。
Protocol Type	Specify the Protocol type FTP、 TFTP or HTTP.
Update Interval	Specify update interval time, unit is hour.
Update Mode	Different update modes: 1. Disable: means no update 2. Update after reboot: means update after reboot. 3. Update at time interval: means periodic update.
<b>TR069 Settings</b>	
Enable TR069	Enable TR069 by selecting it
ACS Server Type	Specify the ACS Server Type
ACS Server URL	Specify the ACS Server URL
ACS User	Specify ACS User
ACS Password	Specify ACS Password
Periodix Interval	It will check every 6 minutes
TR069 Auto Login	Enable TR069 Auto Login by selecting it
"Inform" Sending Period	Specify the “inform” Sending Period, unit is second

### 8.3.6.2 Syslog Config

Syslog is a protocol which is used to record the log messages with client/server mechanism. Syslog server receives the messages from clients, and classifies them based on priority and type. Then these messages will be written into log by some rules which administrator can configure. This is a better way for log management.

8 levels in debug information:

Level 0---emergency: This is highest default debug info level. Your system cannot work.

Level 1---alert: Your system has deadly problem.

Level 2---critical: Your system has serious problem.

Level 3---error: The error will affect your system working.

Level 4---warning: There are some potential dangers. But your system can work.

Level 5---notice: Your system works well in special condition, but you need to check its working environment and parameter.

Level 6---info: the daily debugging info.

Level 7---debug: the lowest debug info Professional debugging info from R&D person.

At present, the lowest level of debug information is info; debug level only can be displayed on telnet.

The screenshot shows the D-Link web interface for a DPH-400GE device. The top navigation bar includes tabs for BASIC, NETWORK, VOIP, PHONE, MAINTENANCE (selected), SECURITY, and LOGOUT. A left sidebar contains menu items: AUTOPROVISION, SYSLOG (selected), CONFIG, UPDATE, ACCESS, and REBOOT. The main content area is divided into four sections:

- Syslog Settings:** Includes fields for Server Address (0.0.0.0), Server Port (514), MGR Log Level (None), SIP Log Level (None), and an Enable Syslog checkbox (unchecked).
- Watch Dog:** Includes an Enable Watch Dog checkbox (checked) and an Apply button.
- Web Capture:** Includes Start and Stop buttons.
- Port Mirror Setting:** Includes a Port Mirror checkbox (unchecked) and an Apply button.

At the bottom of the interface, there is a BROADBAND section.

## Syslog Configuration

Field name	explanation
<b>Syslog Setting</b>	
Server Address	Set Syslog server IP address.
Server Port	Set Syslog server port.
MGR Log Level	Set the level of MGR log.
SIP Log Level	Set the level of SIP log.
Enable Syslog	Select it or not to enable or disable syslog.
<b>Watch Dog</b>	
Enable Watch Dog	Phone will automatically restart in case of failure
<b>Web Capture</b>	
Start	Click the start button when you need capture the WAN packet stream of the phone, then open or save the file as the interface
Stop	Click the end button to stop capturing the packet stream
<b>Port mirror Setting</b>	When Port mirror Setting is enabled, device under the LAN port can obtain the data from WAN port

### 8.3.6.3 Config

The screenshot shows the D-Link web interface for a DPH-400GE device. The top navigation bar includes tabs for BASIC, NETWORK, VOIP, PHONE, MAINTENANCE (selected), SECURITY, and LOGOUT. The left sidebar lists various system functions: AUTOPROVISION, SYSLOG, CONFIG (selected), UPDATE, ACCESS, and REBOOT. The main content area is titled 'Maintenance' and contains three sections:

- Save Configuration:** A section with a 'Save' button and the instruction: 'Click "Save" button to save the configuration files!'.
- Backup Configuration:** A section with the instruction: 'Save all Network and VoIP settings.' and two links: 'Right Click here to Save as Config File(.txt)' and 'Right Click here to Save as Config File(.xml)'.
- Clear Configuration:** A section with a 'Clear' button and the instruction: 'Click "Clear" button to clear the configuration files!'.

At the bottom of the interface, there is a 'BROADBAND' section.

<b>Config Setting</b>	
<b>Field name</b>	<b>explanation</b>
Save Configuration	You can save all changes of configurations. Click the Save button, all changes of configuration will be saved, and be effective immediately.
Backup Configuration	Right clicks on “Right click here...” and select “Save Target As config File(.txt)” then you will save the config file in .txt format, or select “Save Target As config File(.xml)” then you will save the config file in .xml format
Clear Configuration	User can restore factory default configuration and reboot the phone. If you login as Admin, the phone will reset all configurations and restore factory default; if you login as Guest, the phone will reset all configurations except for VoIP accounts (SIP1-4 and IAX2) and version number.

### 8.3.6.4 Update

You can update your configuration with your config file in this web page.

DPH-400GE //	BASIC	NETWORK	VOIP	PHONE	<b>MAINTENANCE</b>	SECURITY	LOGOUT
AUTOPROVISION	<b>Web Update</b>						
SYSLOG	Select File: <input type="text"/> <input type="button" value="Browse"/> (*.z,*.txt,*.xml,*.vcf,*.csv,*.wav) <input type="button" value="Update"/>						
CONFIG	<b>TFTP/FTP Update</b>						
<b>UPDATE</b>	Server Address: <input type="text"/>						
ACCESS	User: <input type="text"/>						
REBOOT	Password: <input type="text"/>						
	File Name: <input type="text"/>						
	Type: <input type="text" value="Application Update"/>						
	Protocol: <input type="text" value="FTP"/>						
	<input type="button" value="Apply"/>						
	<b>Update Logo File</b>						
	Select File: <input type="text"/> <input type="button" value="Browse"/> <input type="button" value="Update"/>						
	<b>Delete Logo File</b>						
	Select File: <input type="text"/> <input type="button" value="Delete"/>						
	<b>Logo File</b>						
BROADBAND							

Update	
Field name	explanation
<b>Web Update</b>	
Web Update	Click the browse button, find out the config file saved before or provided by manufacturer, download it to the phone directly, press “Update” to save. You can also update downloaded update file, logo picture, ring, mmiset file by web.
<b>FTP Update</b>	
Server Address	Set the FTP/TFTP server address for download/upload. The address can be IP address or Domain name with subdirectory.
User	Set the FTP server Username for download/upload.
Password	Set the FTP server password for download/upload.
File name	Set the name of update file or config file. The default name is the MAC of the phone, such as

	000102030405.
<b>Notice:</b> You can modify the exported config file. And you can also download config file which includes several modules that need to be imported. For example, you can download a config file just keep with SIP module. After reboot, other modules of system still use previous setting and are not lost.	
Type	Action type that system want to execute: 1. Application update: download system update file 2. Config file export: Upload the config file to FTP/TFTP server, name and save it. 3. Config fie import: Download the config file to phone from FTP/TFTP server. The configuration will be effective after the phone is reset. 4. Phone book export (.vcf, .csv, .xml): Upload the phonebook file to FTP/TFTP server, name and save it. 5. PhoneBook import (.vcf, .csv, .xml): Download the phonebook file to phone from FTP/TFTP server.
Protocol	Select FTP/TFTP server
<b>Update Logo File</b>	
Select File	Specify the URL of the logo file
<b>Delete Logo File</b>	
Select File	Select the logo that you want to delete
<b>Logo File</b>	
Logo File	Show the logo file

### 8.3.6.5 ACCESS

You can add or delete user account, and change the authority of each user account in this web page.

DPH-400GE /	BASIC	NETWORK	VOIP	PHONE	<b>MAINTENANCE</b>	SECURITY	LOGOUT
AUTOPROVISION	LCD Menu Password Settings						
SYSLOG	Menu Password: <input type="password" value="..."/>						<input type="button" value="Apply"/>
CONFIG	Keyboard Lock Settings						
UPDATE	PIN to Lock: <input type="text"/>						
<b>ACCESS</b>	Keyboard Password: <input type="password" value="..."/>						<input type="button" value="Apply"/>
REBOOT	Enable Keyboard Lock: <input type="checkbox"/>						
	User Settings						
	User		User Level				
	admin		Root				
	guest		General				
	Add User						
	User:		<input type="text"/>				
	Password:		<input type="password"/>				
	Confirm:		<input type="password"/>				
	User Level:		Root <input type="button" value="v"/>				
							<input type="button" value="Apply"/>
	Account Option						
	admin <input type="button" value="v"/>		<input type="button" value="Delete"/>		<input type="button" value="Modify"/>		
BROADBAND							

## Access Configuration

Field name	explanation								
Keyboard Password	Set the password for entering the setting menu of the phone by the phone's key board. The password is digit.								
<table border="1"> <thead> <tr> <th colspan="2">User Settings</th> </tr> <tr> <th>User</th> <th>User Level</th> </tr> </thead> <tbody> <tr> <td>admin</td> <td>Root</td> </tr> <tr> <td>guest</td> <td>General</td> </tr> </tbody> </table>		User Settings		User	User Level	admin	Root	guest	General
User Settings									
User	User Level								
admin	Root								
guest	General								
This table shows the current user existed.									
User	Set account user name.								
User Level	Set user level, Root user has the right to modify configuration, General can only read.								
Password	Set the password.								
Confirm	Confirm the password.								
Select the account and click the <b>Modify</b> to modify the selected account, and click the <b>Delete</b> to delete the selected account.									
General user only can add the user whose level is General.									

### 8.3.6.6 REBOOT

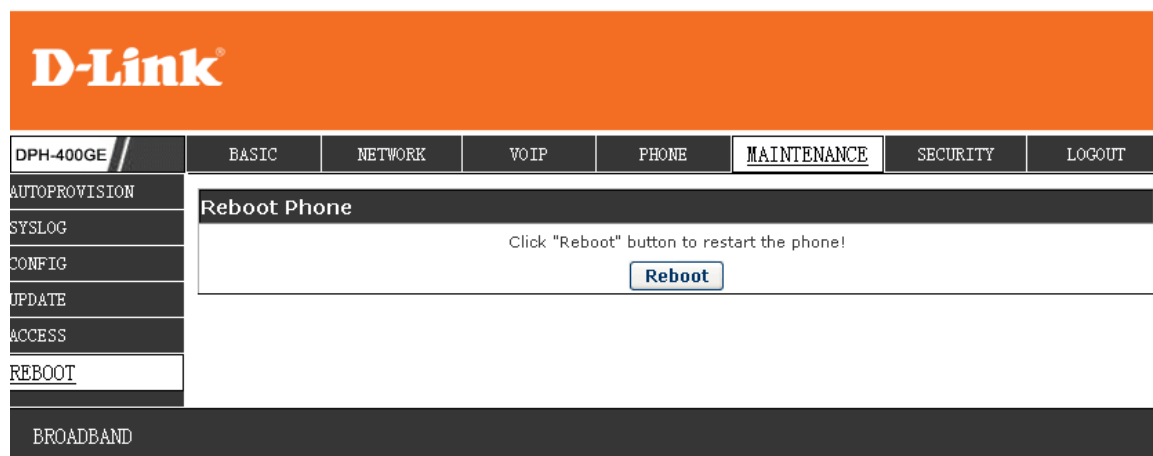

If you modified some configurations which need the phone's reboot to be effective, you need click the Reboot, then the phone will reboot immediately.  
**Notice:** Before reboot, you need confirm that you have saved all configurations.

## 8.3.7 Security

### 8.3.7.1 Web Filter

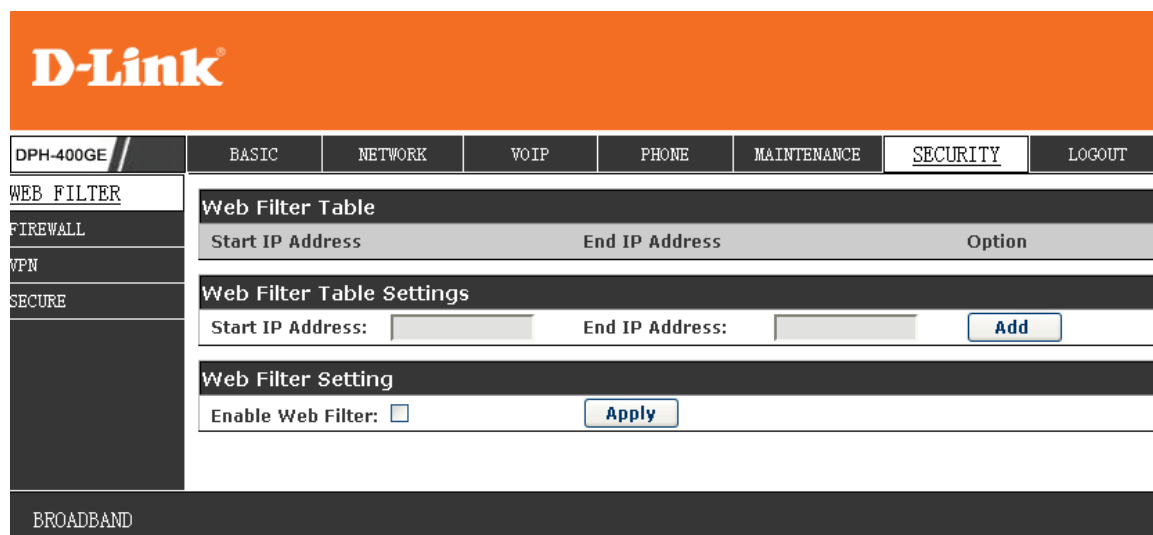

### WEB Filter

User could make some device own IP, which is pre-specified, access to the MMI of the phone to config and manage the phone.

Field name	explanation
------------	-------------

Web Filter Table Settings:

Add or delete the IP address segments that access to the phone.



Set initial IP address in the Start IP column, Set end IP address in the End IP column, and click Add to add this IP segment. You can also click Delete to delete the selected IP segment.

Web Filter setting      Select it or not to enable or disable Web Filter. Click **Apply** to make it effective.

**Notice:** Do not set your visiting IP outside the Web filter range, otherwise, you cannot logon through the web.

### 8.3.7.2 Firewall

The screenshot shows the D-Link web interface for the DPH-400GE device. The 'SECURITY' tab is selected. The 'FIREWALL' section is active, showing the following configuration options:

- Firewall Type:** Enable Input Rules  and Enable output Rules . An **Apply** button is present.
- Firewall Input Rule Table:** A table with columns: Index, Deny/Permit, Protocol, Src Address, Src Mask, Src Port Range, Dst Addr, Dst Mask, Port.
- Firewall Output Rule Table:** A table with columns: Index, Deny/Permit, Protocol, Src Address, Src Mask, Src Port Range, Dst Addr, Dst Mask, Dst Port Range.
- Firewall Settings:**
  - Input/Output: **Input** (dropdown)
  - Src Address: [text input]
  - Dst Addr: [text input]
  - Deny/Permit: **Deny** (dropdown)
  - Src Mask: [text input]
  - Dst Mask: [text input]
  - Protocol: **UDP** (dropdown)
  - Src Port Range: [text input]
  - Des Port Range: [text input]
- Rule Delete Option:**
  - Input/Output: **Input** (dropdown)
  - Index To Be Deleted: [text input]
  - Delete** button

## Firewall Configuration

In this web interface, you can set up firewall to prevent unauthorized Internet users from accessing private networks connected to the Internet (input rule), or prevent unauthorized private network devices from accessing the Internet (output rule).

Firewall supports two types of rules: input access rule and output access rule. Each type supports at most 10 items.

Through this web page, you could set up and enable/disable firewall with input/output rules. System could prevent unauthorized access, or access other networks set in rules for security. Firewall, is also called access list, is a simple implementation of a Cisco-like access list (firewall). It supports two

access lists: one for filtering input packets, and the other for filtering output packets. Each kind of list could be added 10 items.  
We will give you an instance for your reference.

Field name	explanation
Enable Input Rules	Select it to Enable Input Rules
Enable Output Rules	Select it to Enable Output Rules
Input / Output	Specify current adding rule by selecting input rule or output rule.
Deny/Permit	Specify current adding rule by selecting Deny rule or Permit rule.
Protocol	Filter protocol type. You can select TCP, UDP, ICMP, or IP.
Port Range	Set the filter Port range
Src Address	Set source address. It can be single IP address, network address, complete address 0.0.0.0, or network address similar to *.*.*.0
Des Address	Set the destination address. It can be IP address, network address, complete address 0.0.0.0, or network address similar to *.*.*.*
Src Mask	Set the source address' mask. For example, 255.255.255.255 means just point to one host; 255.255.255.0 means point to a network which network ID is C type.
Dest Mask	Set the destination address' mask. For example, 255.255.255.255 means just point to one host; 255.255.255.0 means point to a network which network ID is C type.

Click the **Add** button if you want to add a new output rule.  
Then enable out access, and click the Apply button.  
So when devices execute to ping 192.168.1.118, system will deny the request to send icmp request to 192.168.1.118 for the out access rule. But if devices ping other devices which network ID is 192.168.1.0, it will be normal.

Click the **Delete** button to delete the selected rule.

Click the **Add** button if you want to add a new output rule.  
Then enable out access, and click the Apply button.  
So when devices execute to ping 192.168.1.118, system will deny the request to send icmp request to 192.168.1.118 for the out access rule. But if devices ping other devices which network ID is 192.168.1.0, it will be normal.

Click the **Delete** button to delete the selected rule.

### 8.3.7.3 VPN

This web page provides us a safe connect mode by which we can make remote access to enterprise inner network from public network. That is to say, you can set it to connect public networks in different areas into inner network via a special tunnel.

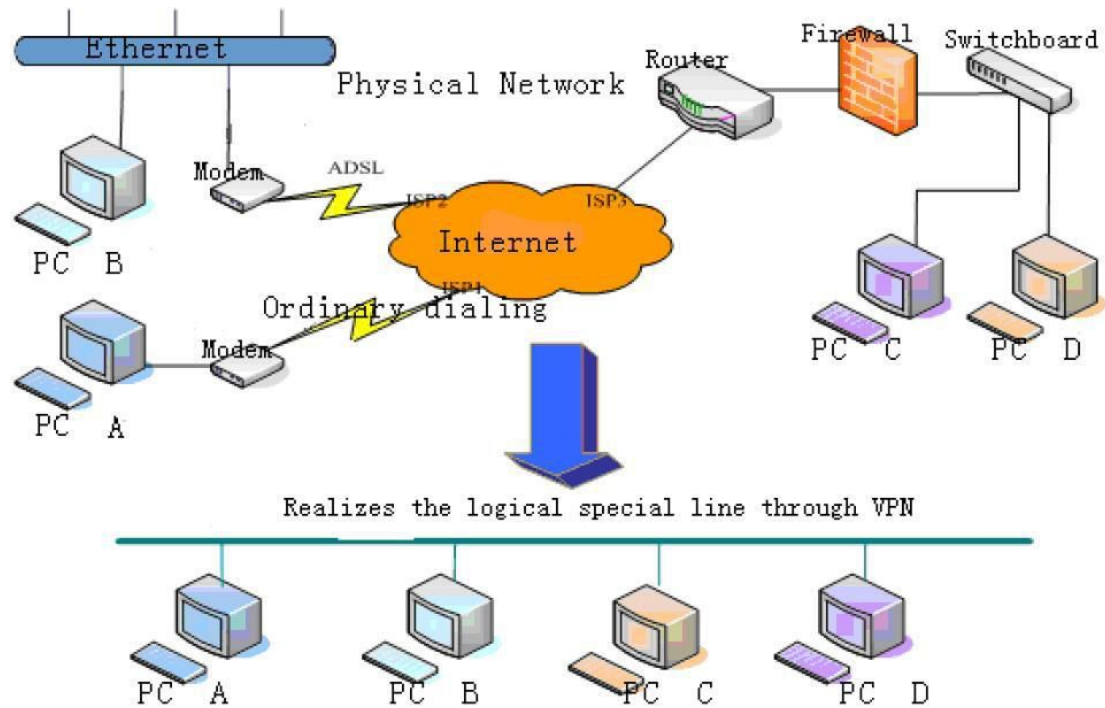

## D-Link

<b>DPH-400GE</b>	BASIC	NETWORK	VOIP	PHONE	MAINTENANCE	<b>SECURITY</b>	LOGOUT
WEB FILTER	<div style="background-color: #f0f0f0; padding: 2px;"><b>Virtual Private Network (VPN) Status</b></div> <div style="border: 1px solid #ccc; padding: 2px; margin-top: 2px;">IP Address: 0.0.0.0</div> <div style="background-color: #f0f0f0; padding: 2px; margin-top: 5px;"><b>VPN Mode</b></div> <div style="padding: 2px; margin-top: 2px;"> <input type="checkbox"/> Enable VPN  <input type="radio"/> L2TP <span style="margin-left: 100px;"><input checked="" type="radio"/> OpenVPN</span> </div> <div style="background-color: #f0f0f0; padding: 2px; margin-top: 5px;"><b>Layer 2 Tunneling Protocol (L2TP)</b></div> <div style="padding: 2px; margin-top: 2px;">           VPN Server Address: <input style="width: 100px;" type="text"/> VPN User: <input style="width: 100px;" type="text"/>            VPN Password : <input style="width: 100px;" type="password"/> </div> <div style="text-align: center; margin-top: 5px;"> <input type="button" value="Apply"/> </div>						
FIREWALL							
VPN							
SECURE	BROADBAND						

<h2 style="margin: 0;">VPN Configuration</h2>	
<b>Field name</b>	<b>explanation</b>

VPN IP	Shows the current VPN IP address
Select L2TP. You can choose only one for current state. After you select it, you'd better save configuration and reboot your phone.	
Enable VPN	Select it or not to enable or disable VPN;
VPN Server Addr	Set VPN L2TP Server IP address
VPN User Name	Set User Name access to VPN L2TP Server
VPN Password	Set Password access to VPN L2TP Server

### 8.3.7.4 Security

<b>Security</b>	
<b>Field name</b>	<b>explanation</b>
<b>Update Security File</b>	
Select Security File	Select the security file you want to update, then click Update button to update
<b>Delete Security File</b>	
Select Security File	Select the security file you want to delete, then click Delete button to update
SIP TLS File	Show SIP TLS authentication certification file
HTTPS File	Show HTTPS authentication certification file

Open VPN Files

Show Open VPN File authentication certification file

### 8.3.8 Logout

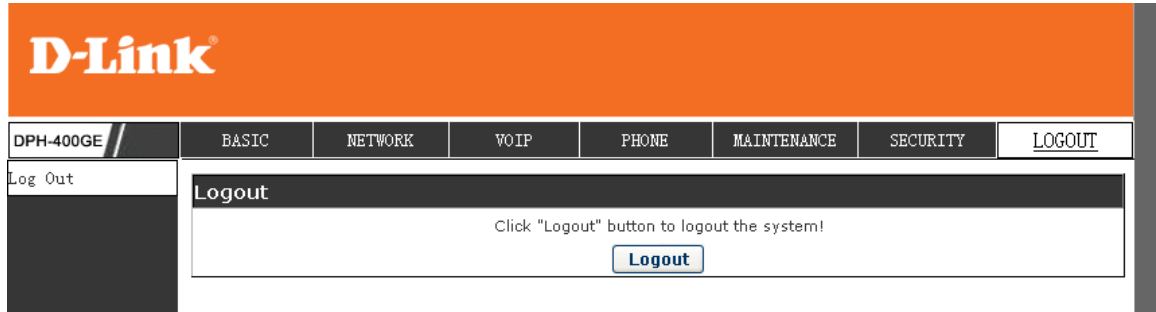

Click **Logout**, and you will exit web page. If you want to enter it next time, you need input user name and password again.

# 9 Appendix

## 9.1 Specification

### 9.1.1 Hardware

Item	DPH-400G/DPH-400GE	
Adapter (Input / Output)	Input: 100-240V Output: 5V 1A	
port	WAN	10/100Base- T RJ-45 1 PORT
	LAN	10/100Base- T RJ-45 1 PORT
	EXT	RJ11 1 PORT
Power Consumption	Idle: 2.5W/Active: 2.8W	
LCD Size	128x64 53.5 x 70mm	
Operation Temperature	0~40℃	
Relative Humidity	10~65%	
CPU	Broadcom	
SDRAM	64MB	
Flash	128MB	
Dimension(L x W x H)	295×295×175mm	
Weight	1.5kg	

### 9.1.2 Voice features

- SIP supports 5 SIP servers
- Support SIP 2.0 (RFC3261) and correlative RFCs
- Codec: G.711A/u, G.722, G.723.1,G.726-32,G.729.AB,ILBC, AMR, AMR-WB
- Echo cancellation: G.168 Compliance in LEC, additional acoustic echo cancellation(AEC) can reach 96ms max filter length in hands-free mode
- Support Voice Gain Setting, VAD, CNG
- Support full duplex hands-free
- Support multi line/HD Voice

- SIP support SIP domain, SIP authentication(none basic, MD5), DNS name of server, Peer to Peer/ IP call
- Automatically select calling line, if one line can't be connected, the phone can automatically switch to other line to call.
- 9 kinds of ring types and 3 user-defined music rings
- DTMF Relay: support SIP info, DTMF Relay, RFC2833
- SIP application: SIP Call forward/transfer (blind/attended) /hold/waiting/3 way talking/SMS/pickup /join call /redial /unredial/multi line/intercom/BLF/presence/push to talk/auto redial/call return
- Call control features: Flexible dial map, hotline, empty calling No. reject service, black list for reject authenticated call, white list, limit call, no disturb, caller ID, CLIR(reject the anonymous call), CLIP(make a call with anonymous), Dial without register.
- Support phonebook 500 records, Incoming calls / outgoing calls / missed calls. Each supports 100 records.
- 6 line keys defined as multi line with screen display or used as SIP line keys
- 8 DSS keys
- Soft keys programmable, function keys programmable
- Code synchronization via IP PBX/IMS
- Support EXT DSS consoles with 5 max
- Support click to dial via web phone book
- Voice codec setting for each SIP line
- Support keypad lock, and emergency call during the keypad lock
- Customized lcd logo
- Ring play via headset or speaker setting
- Signal tone parameters customized
- Phonebook supports vcard standard
- 12/24 hours time display
- Support daylight saving time
- Support path, group
- Support SIP Privacy
- Support SMS
- Support WMI
- Support Speed dial
- Support XML

### **9.1.3 Network features**



- WAN: support bridge model
- Support PPPoE for xDSL
- Support VLAN (optional: voice vlan/ data vlan)
- Support VPN (L2TP) function

- Wan Port supports main DNS and secondary DNS server, can select dynamically to get DNS in DHCP mode or statically set DNS address.
- Support DHCP client on WAN
- QoS with DiffServ
- Network tools in telnet server: including ping, telnet client
- Support Gigabit Ethernet

### 9.1.4 Maintenance and management

- Upgrade firmware through POST mode
- Web ,telnet and keypad management
- Management with different account right
- LCD and WEB configuration can be modified into requested language, and support multi-language dynamically shifted
- Upgrade firmware through HTTP,HTTPS FTP or TFTP Telnet remote management/ upload/download setting file
- Support Syslog
- Support Auto Provisioning (upgrade firmware or configuration file)

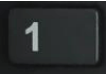
## 9.2 Digit-character map table

Keypad	Character	Keypad	Character
	1 @		7 P Q R S p q r s
	2 A B C a b c		8 T U V t u v
	3 D E F d e f		9 W X Y Z w x y z
	4 G H I g h i		*./
	5 J K L j k l		0
	6 M N O m n o		#/=