

# Fanvil Product User Manual

## IP Phone

### Model: C62



**Corporate Headquarters**  
**Fanvil Technology Co., Ltd**  
**Address: Unit 4A, Building NO.7,**  
**Tian An Industrial Park, Nan Shan District, Shenzhen 518054 China**  
**Web Site: [www.Fanvil.com](http://www.Fanvil.com)**  
**Tel: +86 755 26402199**  
**Fax: +86 755 26402618**



## Safety Notices

Please read the following safety notices before installing or using this phone. They are crucial for the safe and reliable operation of the device.

- Please use the external power supply that is included in the package. Other power supplies may cause damage to the phone, affect the behavior or induce noise.
- Before using the external power supply in the package, please check with home power voltage. Inaccurate power voltage may cause fire and damage.
- Please do not damage the power cord. If power cord or plug is impaired, do not use it, it may cause fire or electric shock.
- The plug-socket combination must be accessible at all times because it serves as the main disconnecting device.
- Do not drop, knock or shake it. Rough handling can break internal circuit boards.
- Do not install the device in places where there is direct sunlight. Also do not put the device on carpets or cushions. It may cause fire or breakdown.
- Avoid exposure the phone to high temperature, below 0°C or high humidity.

Avoid wetting the unit with any liquid.

- Do not attempt to open it. Non-expert handling of the device could damage it. Consult your authorized dealer for help, or else it may cause fire, electric shock and breakdown.
- Do not use harsh chemicals, cleaning solvents, or strong detergents to clean it. Wipe it with a soft cloth that has been slightly dampened in a mild soap and water solution.
- When lightning, do not touch power plug or phone line, it may cause an electric shock.
- Do not install this phone in an ill-ventilated place.
- You are in a situation that could cause bodily injury. Before you work on any equipment, be aware of the hazards involved with electrical circuitry and be familiar with standard practices for preventing accidents.

# Table of Content

<b>1</b>	<b><u>INTRODUCING C62 VOIP PHONE</u></b> .....	<b>6</b>
1.1	<u>THANK YOU FOR YOUR PURCHASING C62</u> .....	6
1.2	<u>DELIVERY CONTENT</u> .....	6
1.3	<u>KEYPAD</u> .....	6
1.4	<u>PORT FOR CONNECTING</u> .....	8
1.5	<u>ICON INTRODUCTION</u> .....	8
1.6	<u>LED INTRODUCTION</u> .....	9
<b>2</b>	<b><u>INITIAL CONNECTING AND SETTING</u></b> .....	<b>11</b>
2.1	<u>CONNECT THE PHONE</u> .....	11
2.1.1	<u>Connect to network</u> .....	11
2.1.2	<u>Power adaptor connection</u> .....	12
2.2	<u>BASIC INITIALIZATION</u> .....	12
2.2.1	<u>Network settings</u> .....	12
<b>3</b>	<b><u>C62'S BASIC FUNCTION</u></b> .....	<b>14</b>
3.1	<u>MAKING A CALL</u> .....	14
3.1.1	<u>Call Device</u> .....	14
3.1.2	<u>Call Methods</u> .....	14
3.2	<u>ANSWERING A CALL</u> .....	14
3.3	<u>DND</u> .....	15
3.4	<u>CALL FORWARD</u> .....	15
3.5	<u>CALL HOLD</u> .....	15
3.6	<u>CALL WAITING</u> .....	15
3.7	<u>MUTE</u> .....	16
3.8	<u>CALL TRANSFER</u> .....	16
3.9	<u>3-WAY CONFERENCE CALL</u> .....	16
3.10	<u>MULTIPLE-WAY CALL</u> .....	17
<b>4</b>	<b><u>C62'S ADVANCED FUNCTION</u></b> .....	<b>18</b>
4.1	<u>CALL PICKUP</u> .....	18
4.2	<u>JOIN CALL</u> .....	18
4.3	<u>REDIAL / UNREDIAL</u> .....	18
4.4	<u>CLICK TO DIAL</u> .....	19
4.5	<u>CALL BACK</u> .....	19
4.6	<u>AUTO ANSWER</u> .....	19
4.7	<u>HOTLINE</u> .....	19
4.8	<u>APPLICATION</u> .....	19
4.8.1	<u>SMS</u> .....	19
4.8.2	<u>Memo</u> .....	20
4.8.3	<u>Voice Mail</u> .....	20
4.9	<u>PROGRAMMABLE KEY CONFIGURATION</u> .....	20

<b>5</b>	<b><u>C62'S BASIC SETTING</u></b> .....	<b>23</b>
5.1	<u>KEYBOARD</u> .....	23
5.2	<u>SCREEN SET</u> .....	23
5.3	<u>RINGER SET</u> .....	23
5.4	<u>VOICE VOLUME</u> .....	23
5.5	<u>TIME &amp; DATE</u> .....	23
5.6	<u>GREETING WORD</u> .....	24
5.7	<u>LANGUAGE SET</u> .....	24
<b>6</b>	<b><u>C62'S ADVANCED SETTINGS</u></b> .....	<b>25</b>
6.1	<u>ACCOUNT</u> .....	25
6.2	<u>NETWORK</u> .....	25
6.3	<u>SECURITY</u> .....	25
6.4	<u>MAINTENANCE</u> .....	25
6.5	<u>FACTORY RESET</u> .....	25
<b>7</b>	<b><u>WEB CONFIGURATION</u></b> .....	<b>26</b>
7.1	<u>INTRODUCTION OF CONFIGURATION</u> .....	26
7.1.1	<u>Ways to configure</u> .....	26
7.1.2	<u>Password Configuration</u> .....	26
7.2	<u>SETTING VIA WEB BROWSER</u> .....	26
7.3	<u>CONFIGURATION VIA WEB</u> .....	27
7.3.1	<u>BASIC</u> .....	27
7.3.1.1	<u>Status</u> .....	27
7.3.1.2	<u>Wizard</u> .....	28
7.3.1.3	<u>Call Log</u> .....	30
7.3.1.4	<u>MMI SET</u> .....	31
7.3.2	<u>Network</u> .....	32
7.3.2.1	<u>WAN Config</u> .....	32
7.3.2.2	<u>LAN Config</u> .....	34
7.3.2.3	<u>Qos Config</u> .....	35
7.3.2.4	<u>Service Port</u> .....	37
7.3.2.5	<u>DHCP SERVER</u> .....	39
7.3.2.6	<u>SNTP</u> .....	40
7.3.3	<u>VOIP</u> .....	42
7.3.3.1	<u>SIP Config</u> .....	42
7.3.3.2	<u>IAX2 Config</u> .....	47
7.3.3.3	<u>Stun Config</u> .....	48
7.3.3.4	<u>DIAL PEER setting</u> .....	50
7.3.4	<u>Phone</u> .....	53
7.3.4.1	<u>DSP Config</u> .....	53
7.3.4.2	<u>Call Service</u> .....	54
7.3.4.3	<u>Digital Map Configuration</u> .....	57
7.3.4.4	<u>Phone Book</u> .....	58

7.3.4.5	<u>Function Key</u> .....	60
7.3.5	<u>Maintenance</u> .....	64
7.3.5.1	<u>Auto Provision</u> .....	64
7.3.5.2	<u>Syslog Config</u> .....	65
7.3.5.3	<u>Config Setting</u> .....	66
7.3.5.4	<u>Update</u> .....	67
7.3.5.5	<u>Account Config</u> .....	68
7.3.5.6	<u>Reboot</u> .....	69
7.3.6	<u>Security</u> .....	70
7.3.6.1	<u>MMI Filter</u> .....	70
7.3.6.2	<u>Firewall</u> .....	71
7.3.6.3	<u>NAT Config</u> .....	73
7.3.6.4	<u>VPN Config</u> .....	75
7.3.7	<u>Logout</u> .....	77
<b>8</b>	<b><u>APPENDIX</u></b> .....	<b>78</b>
8.1	<u>SPECIFICATION</u> .....	78
8.1.1	<u>Hardware</u> .....	78
	<u>Voice features</u> .....	78
8.1.2	<u>Network features</u> .....	79
8.1.3	<u>Maintenance and management</u> .....	80
8.2	<u>DIGIT-CHARACTER MAP TABLE</u> .....	80

# **1 Introducing C62 VoIP Phone**

## **1.1 Thank you for purchasing C62**

Thank you for purchasing C62. C62 is a full-feature telephone that provides voice communication over the same IP network that your computer uses. This phone functions not only much like a traditional phone, allowing to place and receive calls, and enjoy other features that traditional phone has, but also it own many data services features which you could not expect from a traditional telephone.

This guide will help you easily to use the various features and services available on your phone.

## **1.2 Delivery Contents**

Please check whether the delivery contains the following parts:

The base unit with display and keypad

The handset

The handset cable

The power supply



The Ethernet cable

The User Manual

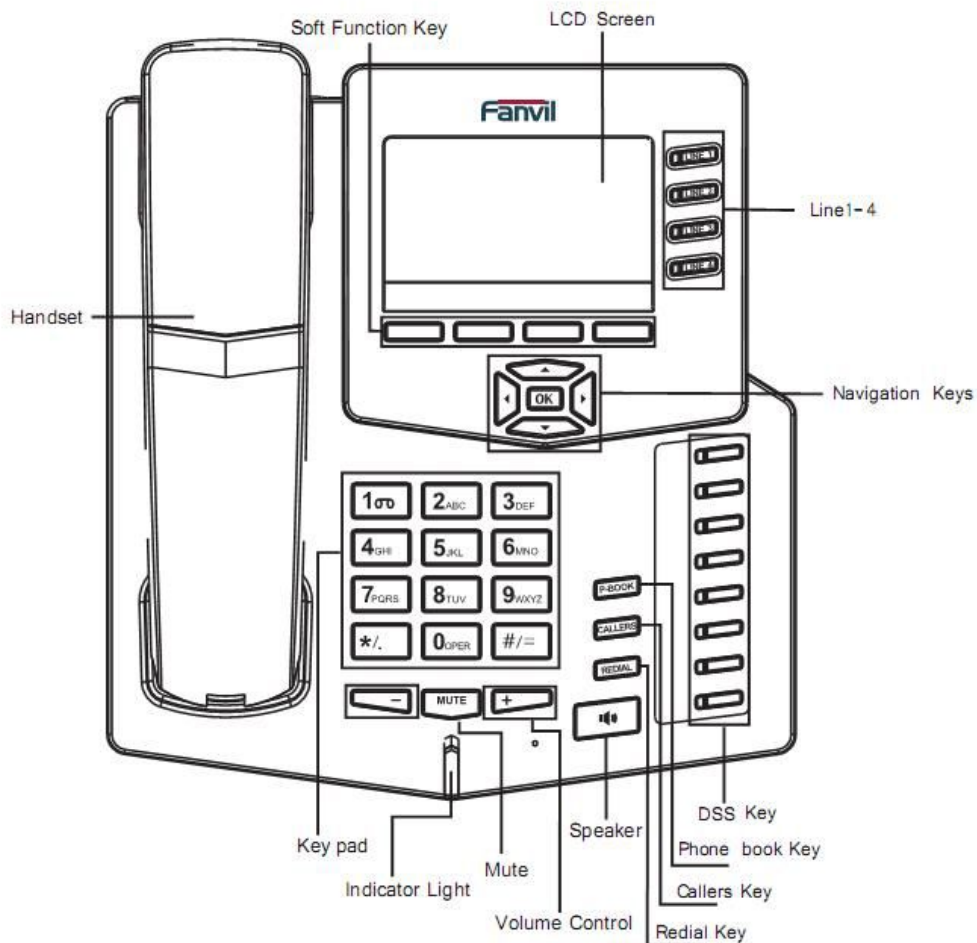
IP Phone is designed to look like conventional phone; the following photo shows a broad overview of the IP Phone.



## 1.3 Keypad

Key	Key name	Function Description
	Navigation	Navigation key assist users for operating. In idle state they have special function. You can configure through the web page according to your patterns of use.
	Phone Book	Access to phone book, and check the record list by adding new records and revising the record. When check the phone book records, press this key again will return to idle interface.
	mute	Press this key in calling mode, and you can hear the other side, and the other side cannot hear you.



Line1/2 /3/4 Here are four SIP lines; user could select any one to make the call, if it has been registered.



Volume +/-

Turn down or turn up the volume by pressing these two keys.



Redial

1. In the hook off /hands-free mode, use the key to dial the last call number;
2. In stand-by mode, it has a function to check the Outgoing Call.

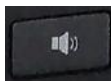

Hands-free

Make the phone into hands-free mode.



Indicator light

If the light blinking, indicate the phone has missed call. It also can indicate there is new incoming call.



Soft key 1/2/3/4

Keys combination, include functions such as History/PBook /DND /Menu /Del /Redial /Send /Quit/Answer/Divert/Reject/Hold/Transfer/Conf/Close and so on.



Callers

View the Missed call, Incoming Call and Outgoing Call.



Digital keyboard

Inputting the phone number or DTMF.









DSS keys

You can configure them with your own functions in the web page.







---









## 1.4 Port for connecting

Port	Port name	description
	Power switch	Input: 5V AC, 1A
	WAN	10/100M Connect it to ether Network
	LAN	10/100M Connect it to PC
	Headset	Port type: RJ-9 connector
	Handset	Port type: RJ-9 connector
	External console interface	Port type: RJ-45 direct connector

## 1.5 Icon introduction

Icon	Description
	Call out
	Call in
	Call hold
	Auto answer
	Call mute
	Contact
	DND(Do not Disturb)

	In hand free mode
	In handset mode
	In headset mode
	SMS
	Missed call
	Call forward

## 1.6 LED introduction

Table 1 Call/Line Appearance Button LEDs for BLF

LED Status	Description
Steady green	The object is in idle status
Slow blinking red	The object is ringing
Steady red	The object is active
Fast blinking red	The object is not available
Off	It is not active as call/line appearance

Table 2 Call/Line Appearance Button LEDs for Presence

LED Status	Description
Steady green	The object is online
Slow blinking red	The object is ringing
Steady red	The object is active
Fast blinking red	The object is not available
Off	It is not active as call/line appearance

Table 3 Line key LEDs

LED Status	Description
Steady green	The account is active
Fast Blinking red	There is an incoming call to the account
Slow Blinking red	The call is on hold
Off	Call/line appearance is active

Table 4 Power Indication LED

LED Status	Description
Steady red	Power on
Fast Blinking red	There is an incoming call
Slow Blinking red	There is a missed call

---

Off

Power off

---

## 2 Initial connecting and Setting

### 2.1 Connect the phone

#### 2.1.1 Connect to network

Step 1: Connect the IP Phone to the corporate IP network. Before you connect the phone to the network, please check if your network can be accessed normally.

You can do this in one of two ways, depending on how your workspace is set up.

Direct network connection—by this method, you need at least one available Ethernet port in your workspace. Use the Ethernet cable in the package to connect WAN port on the back of your phone to the Ethernet port in your workspace. Since this VoIP Phone has router functionality, whether you have a broadband router or not, you can make direct network connect. The following two figures are for your reference.

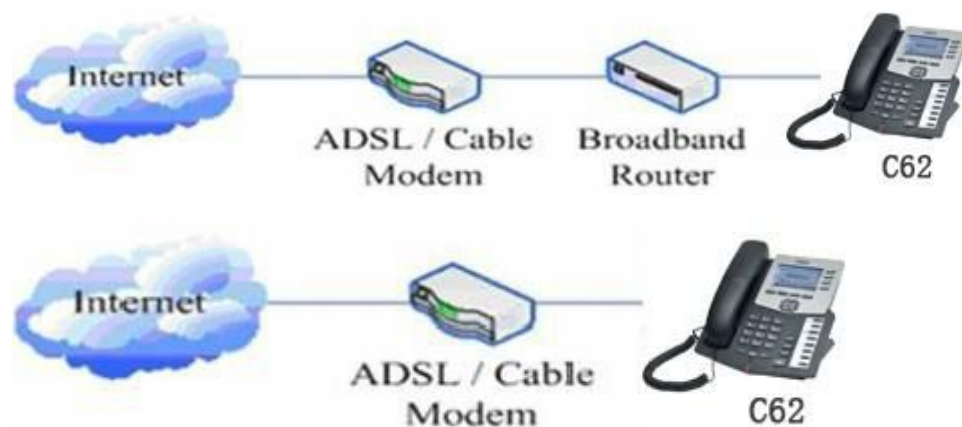

Shared network connection—Use this method if you have a single Ethernet port in your workspace with your desktop computer already connected to it. First, disconnect the Ethernet cable from the computer and attach it to the WAN port on the back of your phone. Next, use the Ethernet cable in the package to connect LAN port on the back of your phone to your desktop computer. Your IP Phone now shares a network connection with your computer. The following figure is for your reference.



Step 2: Connect the handset to the handset port by the handset cable in the package.

Step 3: connect the power supply plug to the DC 5V adapter port on the back of the phone. Use the power cable to connect the power supply to a standard power outlet in your workspace.

Step 4: After power up, the phone's LCD screen displays "Initializing". Later, a ready screen typically displays the date, time.

If your LCD screen displays different information from the above, you need refer to the next section "Initial setting" to set your network online mode.

If your VoIP phone registers into corporate IP telephony Server, your phone is ready to use.

## 2.1.2 Power adaptor connection

Make sure that the power you use is comply with the parameters of power adaptor.

1. Plug power adaptor to power socket.
2. Plug power adaptor's DC output to the DC5V port of C62 to start up.
3. There will be displayed "initializing" on the screen. After finishing startup, phone will show current date and time and so forth.
4. If phone has registered to the server, you can place or answer calls.

## 2.2 Basic Initialization

C62 is provided with a plenty of functions and parameters for configuration. User needs some network and VoIP knowledge so that he could understand the meanings of parameters. In order to make user use the phone more easily and conveniently, there are basic configurations introduced which is mandatory to ensure phone calls available.

### 2.2.1 Network settings

Make sure that network is connected already before setting network of phone. C62 uses DHCP to get WAN IP configurations, so phone could access to network as long as there is DHCP server in it. If there is no DHCP server available, phone has to be changed WAN network setting to Static IP or PPPoE.

### **Setting PPPoE mode (for ADSL connection)**

1. Get PPPoE account and password first.
2. Press soft4 (Menu)->Settings->Advanced Setting, then enter passwords(123), and choose network ->WAN->Net Mode, enter and choose PPPoE through navigation keys and press the Save key.
3. Press Soft4 (Quit), then choose PPPoE Set, press soft3 (enter).
4. The screen will show the current information. Press Soft1 (Del) to delete it, then input your PPPoE user and password and press Soft3 (Save).
5. Press Soft3 (Quit) six times to return to the idle screen.
6. Check the status. If the screen shows “**Negotiating...**” it shows that the phone is trying to access to the PPPoE Server; if it shows an IP address, then the phone has already get IP with PPPoE.

### **Setting Static IP mode (static ADSL/Cable, or no PPPoE / DHCP network)**

1. Prepare the network's parameters first, such as IP Address, Net mask, Default Gateway and DNS server IP addresses. If you don't know these information, please contact the service provider or technician of network.
2. Press Menu->Settings->Advanced Setting, then enter passwords(123), and choose network ->WAN->Net Mode, enter and choose Static through navigation keys and press the Save key.
3. Press Quit, then choose Static Set, press Enter.
4. The screen will show the current information, and then press Del to delete. Input your IP address, Mask, Gateway, DNS, and press “save” key to save what you input.
5. Press Quit six times to return to the idle screen.
6. Check the status, the screen shows “**Static**” .the screen shows the IP address and gateway which were set just now, if the phone could display the right time, it shows that Static IP mode takes effect.

### **Setting DHCP mode**



1. Press Menu->Settings->Advanced Setting, then enter passwords, and choose network ->WAN->Net Mode, enter and choose DHCP through navigation keys and press the Save key.
2. Press Quit six times to return to the idle screen.
3. Check the status, the screen shows “**DHCP**”, If the screen shows the IP address and gateway which were set just now, it shows that DHCP mode takes effect.

## 3 C62's basic function

### 3.1 Making a call

#### 3.1.1 How to make/answer calls

You can make a phone call via the following devices:

1. Pick up the handset,  icon will be showed in the idle screen.
2. Press the Speaker button,  icon will be showed in the idle screen.
3. Press the Headset button if the headset is connected to the Headset Port in advance. The icon  will be showed in the idle screen.

#### 3.1.2 Call Methods

You can press an available line button if there is more than one account, then dial the number you want to call.

1. Press the Directory soft key, and then use the navigation key to highlight you're choosing.
  2. Press History soft key, use the navigation key to highlight your choosing (press Left/Right button to choose Missed Calls, Incoming Calls and Outgoing Calls.
  3. Press the Redial button to call the last number called.
  4. Press the DSS keys which are set as speed dial buttons.
- Then press the Send button or Send softkey to make the call if necessary.

### 3.2 Answering a call

#### Answering an incoming call

1. If you have just one incoming call, lift the handset, or press the Speaker button/ Answer softkey to answer using the speakerphone, or press the headset button to answer the call.
2. If you have already in calls and need to answer the new call, press the answer softkey.

During the conversation, you can alternate between Headset, Handset and Speaker phone by pressing the corresponding buttons or picking up the handset.

### 3.3 DND

Press DND softkey to active DND Mode. Further incoming calls will be rejected and the display shows:  icon. Press DND softkey again to deactivate DND mode. If there are some incoming calls rejected in DND mode, you can find the incoming call records in the Call History.

### 3.4 Call Forward

This feature allows you to forward an incoming call to another phone number. The display showed  icon.

The following call forwarding events can be configured:

**Off:** Call forwarding is deactivated by default.

**Always:** Incoming calls are immediately forwarded.

**Busy:** Incoming calls are immediately forwarded when the phone is busy.

**No Answer:** Incoming calls are forwarded when the phone is not answered after a specific period time.

To configure Call Forward via Phone interface:

1. Press Menu ->Features->Enter->Call Forward->Enter.
2. There are 4 options: Off, Always, Busy, No Answer.
3. If you choose one of them (except Off), enter the phone number you want to forward your calls to. Press Save to save the changes.

### 3.5 Call Hold

1. Press the Hold button or Hold softkey to put your active call on hold.
2. If there is only one call on hold, press the Unhold softkey to retrieve the call.
3. If there are more than one call on hold, press the line button, and the Up/Down button to highlight the call, then press the Unhold button to retrieve the call.

### 3.6 Call Waiting

1. Press Menu ->Features->Enter->Call Waiting->Enter.
2. Use the navigation keys to active or deactivate call waiting.
3. Then press the Save to save the changes.



## 3.7 Mute

Press Mute button during the conversation, icon  will be showed in the LCD.

Then the other side will not hear you, but you can hear him. Press it again to get the phone to normal conversation.

## 3.8 Call transfer

### 1. Blind Transfer

During talk, press the key Transf, and then dial the number that you want to transfer to, and finished by "#". Phone will transfer the current call to the third party. After finishing transfer, the call you talk to will be hanged up. User can not select SIP line when phone transfers call.

### 2. Attended Transfer

During talk, press the key Transf, then input the number that you want to transfer to and press soft key-Send. After that third party answers, then press Transfer to complete the transfer. (You need enable call waiting and call transfer first). If there are two calls, you can just talk to one, and keep hold to the other one. The one who is keep hold cannot speak to you or hear from you. Note: the server that user uses must support RFC3515 or it might not be used

### 3. Semi attended Transfer

During the talk, press Transf firstly, and then press soft key-Send after inputting the number that you want to transfer. You are waiting for answering; now, press Transf and the transfer will be done. (To use this feature, you need enable call waiting and call transfer first).

## 3.9 3-way conference call

1. Press the Conf softkey during an active call.
2. The first call is placed on hold. Then you will hear a dial tone. Dial the number to conference in, then press Send key.
3. When the call is answered, press Conf and add the first call to the conference.
4. If you want to release the conference, press Split key.

## 3.10 Multiple-way call

If user has 4 line calls and wants to invite the five party during the call, they can press Conf or Transf “New Call”, press OK, enter the number ,then press Send and wait for the other party to answer. When the multiple-way calls, you

can press the arrow keys to select a call.

## 4 C62's advanced function

### 4.1 Call pickup

Call pickup is implemented by simulating pickup function of PBX. it's that, when A calls B, B rings but no answer, at this moment, C can hook off and input an appointed prefix plus B's number, pick up A's call and talk with A. The following chart shows how to configure an appointed prefix in dial peer to have call pick up function.

Number	Destination	Port	Mode	Alias	Suffix	Del Length
*1*T	0.0.0.0	5060	SIP	rep:pickup	no suffix	3

\*1\* means appointed prefix code. After making the above configuration, C can dial \*1\* plus B's phone number to pick up A's call. User can set prefix in random, in the case of no affecting current dialing rules.

### 4.2 Join call

When B is calling C, A can join in the existing call by inputting an appointed prefix numbers plus B or C number, if B or C also supports join call. The following chart shows how to configure an appointed prefix in dial peer to have join call function.

Number	Destination	Port	Mode	Alias	Suffix	Del Length
*2*T	0.0.0.0	5060	SIP	rep:joincall	no suffix	3

\*2\* means appointed prefix code. After making the above configuration, A can dial \*2\* plus B or C number to join B and C's call. User can set prefix in random, in the case of no affecting current dialing rules.

### 4.3 Redial / Unredial

If B is in busy line when A calls B, A will get notice: busy, please hang up. If A want to connect B as soon as B is in idle, he can use redial function at the moment and he can dials an appointed prefix number plus B's number to realize redial function.

What is redial function? A can't not build a call with B when B is in busy, then A will subscribe B's calling mode at 60 second intervals. Once B is available, A will get reminder of rings to hook off, while A hooks off, A will call B automatically. If at this time A is occupied temporarily and unwilling to contact B, A also can cancel the redial function by dialing an appointed prefix plus B's number before making the redial function.

Number	Destination	Port	Mode	Alias	Suffix	Del Length
*3*T	0.0.0.0	5060	SIP	rep:redial	no suffix	3
*4*T	0.0.0.0	5060	SIP	rep:unredial	no suffix	3

\*3\* is appointed prefix code. After making the above configuration, A can dial \*3\* plus B's phone number to make the redial function.

\*4\* is appointed prefix code. After configuration, A can dial \*4\* to cancel redial function.

User can set prefix in random, in the case of no affecting current dialing rules.

## 4.4 Click to dial

When user A browses in an appointed Web page, user A can click to call user B via a link (this link to user B), then user A's phone will ring, after A hooks off, the phone will dial to B.

## 4.5 Call back

This function allows you dial out the last incoming phone call.

## 4.6 Auto answer

When there is an incoming call, after no answer time arrived, the phone will answer the call automatically.

## 4.7 Hotline/Warmline

You can set hotline number for every sip, and dial the number immediately when you hook off; if you set up Warm Line Time, the phone will play dial tone first. After warm line time is timed out, phone would call out the hotline number automatically

## 4.8 Application

### 4.8.1 SMS

- 1) Press Menu ->Application->Enter->SMS->Enter.
- 2) Use the navigation keys to highlight the options. You can read the message in the Inbox/Outbox.
- 3) After view the new message, you can press Reply to reply the message, and use the 123 softkey to change the Input Method, when enter the reply message,

press OK, then use the navigation keys to select the line from which you want to send, then Send.

4) If you want to write a message, you can press New and enter message. Use the 123 softkey to change the Input Method. When you input the message you want to send, press OK, then use the navigation keys to select the line from which you want to send, then Send.

5) If you want to delete the message, after view the message, press Del, then you have three options to choose: Yes, All, No.

## 4.8.2 Memo

You can add some memos to record some important things to remind you.

Press Menu->Application->Memo->Enter->Add.

There are some options to configure: Mode, Date, Time, text, Ring. When the configuration is completed, press Save.

## 4.8.3 Voice Mail

1) Press Menu->Voice Mail->Enter.

2) Use the navigation keys to highlight the line for which you want to set, press Edit, and use the navigation key to turn on the mode, and the input the number. Press 123 softkey to choose the proper input method.

3) Press Save to save the change.

4) To view the new voicemail, Press the Voicemail softkey directly. Press Dial, then you may be prompted to enter the password, then you can listen to your new and old messages.

## 4.9 DSS Key Configuration

The phone has 12 programmable keys which are able to set up to many functions per key. The following list shows the functions you can set on the programmable keys and provides a description for each function. The default configuration for each key is N/A which means the key hasn't been set for any functions.

1. Set the type as Memory Key

Press Menu->Settings->Basic Setting->Enter->DSS Key, you have two options: Line As DSS Keys and Memory As DSS Keys, choose one you want to make the assignment, use the navigation key to choose the type as memory key. In the Dial field, you have some options, such as Normal, Speed Dial, Intercom, BLF, Presence, and MWI.

### Speed dial

You can configure the key as a simplified speed dial key. This key function

allows you to easily access your most dialed numbers.

### **Intercom**

You can configure the key for Intercom code and it is useful in an office environment as a quick access to connect to the operator or the secretary.

Note: Your VoIP PBX must support this feature. And make sure the intercom extension enable the Auto-answer function.

### **BLF**

BLF is also called “Busy lamp field”, and it is used to prompt the user to pay attention to the state of the object than has been subscribed, and used to cooperate with the server to pick up the phone call. You can configure the key for Busy Lamp Field (BLF) which allows you to monitor the status (idle, ringing, or busy) of other SIP account. User can dial out on a BLF configured key. Please refer to “LED Instruction” for more detail about the LED status in different situation.

Note: In the Web interface, you can also set the pickup number to active the pickup function. For example, if you set the BLF number as 212, and the pickup number is 189, then when there is an incoming call to 212, press the BLF key, it will call out the 189 automatically to pick up the incoming call on 212.

### **Presence**

Presence is called present, and compared to the BLF, it can also check whether object online

### **MWI**

When the key is configured as MWI, you are allowed to access voicemail quickly by pressing this key.

2. Set the type as Line

You can set these keys as line keys, and press it, it will enter dialer interface.

3. Set the type as Key Event

You can set these keys as Key Event, and the subtype have many options.

Choose one and it will have corresponding function.

- None
- MWI
- DND (Do Not Disable)
- Hold
- A\_Transfer (Attended Transfer)
- B\_Transfer (Blind Transfer)
- Phone Book
- Redial
- Pick up
- Join
- Auto-redial
- CFwd (Call Forward)
- History (Call Record)
- Flash

- Memo
- Headset
- Release: Press the key you can end the call.
- Lock: Press the key you can lock the keyboard.
- SMS
- Call Back

4. Set the type as Dtmf

You can configure the key as Dtmf. This key function allows you to easily dial or edit dial number.

5. Set the type as Remote

You need to match a XML Phonebook address, pressing the button you can directly access the corresponding remote phonebook.

6. Set the type as BLF List Key

It needs the cooperation with the Broadsoft server. The traditional BLF is that every number will need to be subscribed, so if the numbers that subscribed is so many that it will cause to obstruction. However, BLF List Key will put the numbers that needed to be subscribed in a group, and the phone use the URL of the group to subscribe and analyze the specific information of each number such as number, name, state and so on according to the notifications from the server. Then set the idle Memory key as BLF List Key, later if the state of an object changes, the corresponding LED will change.

## **5 C62's basic setting**

### **5.1 Keyboard**

1. Press Menu ->Settings-> Enter->Basic Setting-> Enter->Keyboard->Enter.
2. There are four items: DSS Keys, Multiplex, Long Click, SoftKey. You can set up respectively on them. Press the key Enter to the interface, then use the navigation keys to choose the function for the key according to you want.
3. Press the key OK to save.

### **5.2 Screen Set**

1. Press Menu ->Settings-> Enter->Basic Setting-> Enter->Screen Set->Enter.
2. You can set Contrast and Brightness, press Enter and use the navigation keys to set, then press the key Save.

### **5.3 Ringer Set**

1. Press Menu ->Settings-> Enter->Basic Setting-> Enter->Ringer Set->Enter.
2. You can set Ringer Volume and Ringer Type, press Enter and use the navigation keys to set, then press the key Save. In the Ringer Type, the default system rings have nine and the custom ringtones have five that can be set through the web page.

### **5.4 Voice Volume**

1. Press Menu ->Settings-> Enter->Basic Setting-> Enter->Voice Volume->Enter.
2. Use the navigation keys to turn down or turn up the voice volume, the press the key Save.

### **5.5 Time & Date**

1. Press Menu ->Settings->Enter->Basic Setting-> Enter->Time & Date->Enter.
2. You have two options to choose: Auto and Manual, use the navigation keys to choose, then press Save.



## **5.6 Greeting Word**

1. Press Menu ->Settings-> Enter->Basic Setting-> Enter->Greeting Word->Enter.
2. You can enter the message and press Save, it will display in the phone screen when the phone start up.

## **5.7 Language Set**

1. Press Menu ->Settings-> Enter->Basic Setting-> Enter->Language Set->Enter.
2. C62 supports 2 languages, you can use the navigation keys to choose. Now there are English and Chinese as 2 default languages.

## **6 C62's advanced settings**

### **6.1 Account**

Press Menu->Enter->Advanced settings, and then input the password to enter the interface, the default password is 123. You can set it through the web page. Then choose Account then press Enter, you can do some sip settings.

### **6.2 Network**

Press Menu->Enter->Advanced settings, and then input the password to enter the interface. Then choose Network and press Enter, you can do network settings, you can refer to 2.2.1 Network settings.

### **6.3 Security**

Press Menu->Enter->Advanced settings, and then input the password to enter the interface. Then choose Security, you can configure Menu Password, Keylock Password, Keylock Status and whether to ban Outgoing.

### **6.4 Maintenance**

Press Menu->Enter->Advanced settings, and then input the password to enter the interface. Then choose Maintenance and press Enter, you can configure Auto Provision, Backup, and Upgrade.

### **6.5 Factory Reset**

Press Menu->Enter->Advanced settings, and then input the password to enter the interface. Then choose Factory Reset and press Enter, you can choose Yes or No.

# 7 Web configuration

## 7.1 Introduction of configuration

### 7.1.1 Ways to configure

C62 has three different ways to different users.

- Use phone keypad.
- Use web browser (recommendatory way) .
- Use telnet with CLI command.

### 7.1.2 Password Configuration

There are two levels to access to phone: root level and general level. User with root level can browse and set all configuration parameters, while user with general level can set all configuration parameters except SIP (1-2) or IAX2's that some parameters cannot be changed, such as server address and port. User will has different access level with different username and password.

- Default user with general level:
  - ◆ username: guest
  - ◆ password: guest
- Default user with root level:
  - ◆ username: admin
  - ◆ password: admin

The default password of phone screen menu is 123.

## 7.2 Setting via web browser

When this phone and PC are connected to network, enter the IP address of the wan port in this phone as the URL (e.g. `http://xxx.xxx.xxx.xxx/` or `http://xxx.xxx.xxx.xxx:xxxx/`).

If you do not know the IP address, you can look it up on the phone's display by

pressing Status button.  
The login page is as below picture

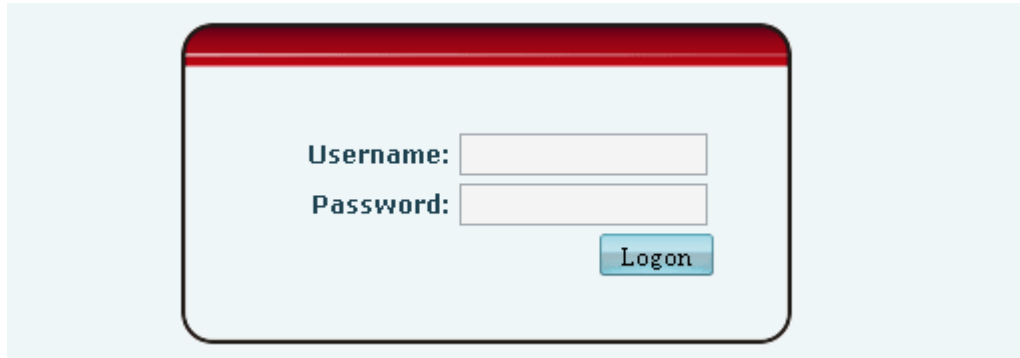

After you configure the ip phone, you need click save button in config under Maintenance in the left catalog to save your configuration. Otherwise the phone will lose your modification after power off and on.

## 7.3 Configuration via WEB

### 7.3.1 BASIC

#### 7.3.1.1 Status

STATUS			
WIZARD			
CALL LOG			
MMI SET			
<b>Network</b>			
WAN		LAN	
Connect Mode	DHCP	IP Address	192.168.10.1
MAC Address	00:01:03:9f:99:14	DHCP Server	ON
IP Address	192.168.1.17		
Gateway	192.168.1.1		
<b>Phone Number</b>			
SIP LINE 1	1111@192.168.1.2 :5060		Registered
SIP LINE 2	4140@192.168.1.2 :5060		Unapplied
SIP LINE 3	4141@192.168.1.4 :5060		Registered
SIP LINE 4	@ :5060		Unapplied
IAX2	@:4569		Unapplied

### Status

Field name	Explanation
Network	Shows the configuration information on WAN and LAN port, including the connect mode of WAN port (Static, DHCP, PPPoE), MAC address, the IP address

	of WAN port and LAN port, ON or OFF of DHCP mode of LAN port.
Phone Number	Shows the phone numbers provided by the SIP LINE 1-4 servers and IAX2. The last line shows the version number and issued date.

### 7.3.1.2 Wizard

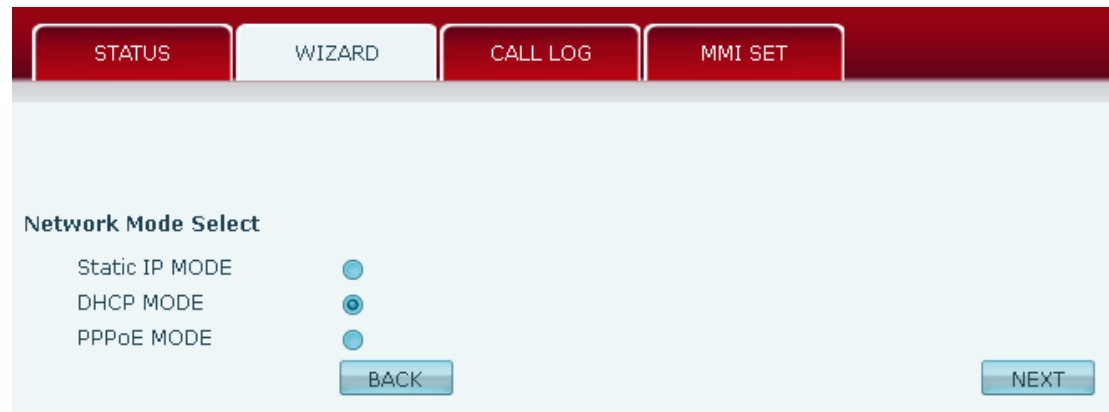

### Wizard

Please select the proper network mode according to the network condition. BW530 provide three different network settings:

- Static: If your ISP server provides you the static IP address, please select this mode, then finish Static Mode setting. If you don't know about parameters of Static Mode setting, please ask your ISP for them.
- DHCP: In this mode, you will get the information from the DHCP server automatically; need not to input this information artificially.
- PPPoE: In this mode, your must input your ADSL account and password.

You can also refer to 3.2.1 Network setting to speed setting your network.

Choose Static IP MODE, click **【NEXT】** can config the network and

SIP(default SIP1) simply, also can browse too. Click **【BACK】** can return to the last page.

**Static IP Set**

Static IP Address

Netmask

Gateway

DNS Domain

Primary DNS

Alter DNS

Static IP Address	Input the IP address distributed to you.
Netmask	Input the Netmask distributed to you.
Gateway	Input the Gateway address distributed to you.
DNS Domain	Set DNS domain postfix. When the domain which you input cannot be parsed, phone will automatically add this domain to the end of the domain which you input before and parse it again.
Primary DNS	Input your primary DNS server address.
Alter DNS	Input your standby DNS server address.

**SIMPLE SIP SET**

Display Name

Server Address

Server Port

User Name

Password

Phone Number

Enable Register

Display Name	Set the display name.
Server Address	Input your SIP server address.
Server Port	Set your SIP server port.
User Name	Input your SIP register account name.
Password	Input your SIP register password.
Phone Number	Input the phone number assigned by your VOIP service provider.
Enable Register	Start to register or not by selecting it or not.

WAN	
Connect Mode	STATIC
Static IP Address	192.168.1.179
Gateway	192.168.1.1

---

SIP	
Register Server	192.168.1.2
User Name	1111
PhoneNumber	1111
Register	ON

Display detailed information that you manual config.

Choose DHCP MODE, click **【NEXT】** can config SIP(default SIP1) simply, also can browse too. Click **【BACK】** can return to the last page. Like Static IP MODE。

Choose PPPoE MODE, click **【NEXT】** can config the PPPoE account/password and SIP(default SIP1) simply, also can browse too. Click **【BACK】** can return to the last page. Like Static IP MODE。

WAN Setting		
Static <input type="radio"/>	DHCP <input type="radio"/>	PPPOE <input checked="" type="radio"/>
<input checked="" type="checkbox"/> Obtain DNS server automatically		
PPPOE Server	<input type="text" value="ANY"/>	
Username	<input type="text" value="user123"/>	
Password	<input type="password" value="....."/>	
<input type="button" value="APPLY"/>		

PPPoE Server	It will be provided by ISP.
Username	Input your ADSL account.
Password	Input your ADSL password.

Notice: Click **【Finish】** button after finished your setting, IP Phone will save the setting automatically and reboot, After reboot, you can dial by the SIP account.

### 7.3.1.3 Call Log

You can query all the outgoing through this page.

#### Call information

Start Time                      Last Time                      Called Number

## Call Log

Field name	explanation
Start Time	Display the start time of the outgoing record.
Last Time	Display the conversation time of the outgoing record.
Called Number	Display the account/protocol/line of the outgoing record.

### 7.3.1.4 MMI SET

The screenshot shows a menu with four tabs: STATUS, WIZARD, CALL LOG, and MMI SET. The MMI SET tab is selected. Below the tabs, there are two sections: 'Language Selection' and 'Greeting Message Set'. In the 'Language Selection' section, there is a label 'Language Set:' followed by a dropdown menu showing 'English'. In the 'Greeting Message Set' section, there is a dropdown menu showing 'Text Message' and a text input field containing 'VOIP PHONE'. At the bottom right, there is an 'APPLY' button.

## MMI SET

Field name	explanation
Language Set	Set the language of phone, English is default.
Greeting Message	The greeting message will display on lcd when phone is idle. It can support 16 chars. the default chars are VOIP PHONE.



## 7.3.2 Network

### 7.3.2.1 WAN Config

WAN	LAN	QOS	SERVICE PORT	DHCP SERVER	SNTF
<b>WAN Status</b>					
Active IP	192.168.1.17				
Current Netmask	255.255.255.0				
Current Gateway	192.168.1.1				
MAC Address	00:01:03:9f:99:14				
Get MAC Time	2011-11-4				
<b>WAN Setting</b>					
Static <input checked="" type="radio"/>		DHCP <input type="radio"/>		PPPOE <input type="radio"/>	
<input checked="" type="checkbox"/> Obtain DNS server automatically					
Static IP Address	<input type="text" value="192.168.1.179"/>				
Netmask	<input type="text" value="255.255.255.0"/>				
Gateway	<input type="text" value="192.168.1.1"/>				
DNS Domain	<input type="text"/>				
Primary DNS	<input type="text" value="202.96.134.133"/>				
Alter DNS	<input type="text" value="202.96.128.68"/>				
<input type="button" value="APPLY"/>					
<b>802.1X Setting</b>					
Username	<input type="text" value="testuser"/>				
Password	<input type="password" value="....."/>				
Enable 802.1x	<input type="checkbox"/>				
<input type="button" value="APPLY"/>					

### WAN Config

#### WAN Status

Active IP	192.168.1.17
Current Netmask	255.255.255.0
Current Gateway	192.168.1.1
MAC Address	00:01:03:9f:99:14
Get MAC Time	2011-11-4

Active IP	The current IP address of the phone.
Current Netmask	The current Netmask address.
MAC Address	The current MAC address of the phone.
Current Gateway	The current Gateway IP address.
Get MAC Time	Shows the time of getting MAC address

## WAN Setting

Static

DHCP

PPPOE

Obtain DNS server automatically

Please select the proper network mode according to the network condition.

BW530 provide three different network settings:

- **Static:** If your ISP server provides you the static IP address, please select this mode, then finish Static Mode setting. If you don't know about parameters of Static Mode setting, please ask your ISP for them.
- **DHCP:** In this mode, you will get the information from the DHCP server automatically; need not to input this information artificially.
- **PPPoE:** In this mode, your must input your ADSL account and password.

You can also refer to 3.2.1 Network setting to speed setting your network.

Obtain DNS server automatically	Select it to use DHCP mode to get DNS address, if you don't select it, you will use static DNS server. The default is selecting it.
---------------------------------	---

Static IP Address	192.168.1.179
Netmask	255.255.255.0
Gateway	192.168.1.1
DNS Domain	
Primary DNS	202.96.134.133
Alter DNS	202.96.128.68

If you use static mode, you need set it.

IP Address	Input the IP address distributed to you.
Netmask	Input the Netmask distributed to you.
Gateway	Input the Gateway address distributed to you.
DNS Domain	Set DNS domain postfix. When the domain which you input cannot be parsed, phone will automatically add this domain to the end of the domain which you input before and parse it again.
Primary DNS	Input your primary DNS server address.
Alter DNS	Input your standby DNS server address.

PPPOE Server	ANY
Username	user123
Password	••••••••

If you uses PPPoE mode, you need to make the above setting.

PPPoE Server	It will be provided by ISP.
Username	Input your ADSL account.
Password	Input your ADSL password.

Notice:

- 1) Click “Apply” button after finished your setting, IP Phone will save the setting automatically and new setting will take effect.
- 2) If you modify the IP address, the web will not response by the old IP address. You need input new IP address in the address column to logon in the phone.
- 3) If networks ID which is DHCP server distributed is same as network ID which is used by LAN of system, system will use the DHCP IP to set WAN, and modify LAN’s networks ID(for example, system will change LAN IP from 192.168.10.1 to 192.168.11.1) when system uses DHCP client to get IP in startup; If system uses DHCP client to get IP in running status and network ID is also same as LAN’s, system will refuse to accept the IP to configure WAN. So WAN’s active IP will be 0.0.0.0

### 7.3.2.2 LAN Config

### LAN Config

Field name	explanation
LAN IP	Specify LAN static IP.
Netmask	Specify LAN Netmask.
DHCP Service	Select the DHCP server of LAN port or not. After you modify the LAN IP address, phone will amend and adjust the DHCP Lease Table and save the result amended automatically according to the IP address and Netmask. You need restart the phone and the DHCP server setting will take effect.
NAT	Select NAT or not.
Bridge Mode	Select Bridge Mode or not: If you select Bridge Mode, the phone will no longer set IP address for LAN physical port, LAN and WAN will join in the same network. Click “Apply”, the phone will reboot.

Notice: If you choose the bridge mode, the LAN configuration will be disabled.

### 7.3.2.3 Qos Config

The VOIP phone support 802.1Q/P protocol and DiffServ configuration. VLAN functionality can use different VLAN IDs for WAN and LAN port. The VLAN application of this phone is very flexible.

Do not use VLAN

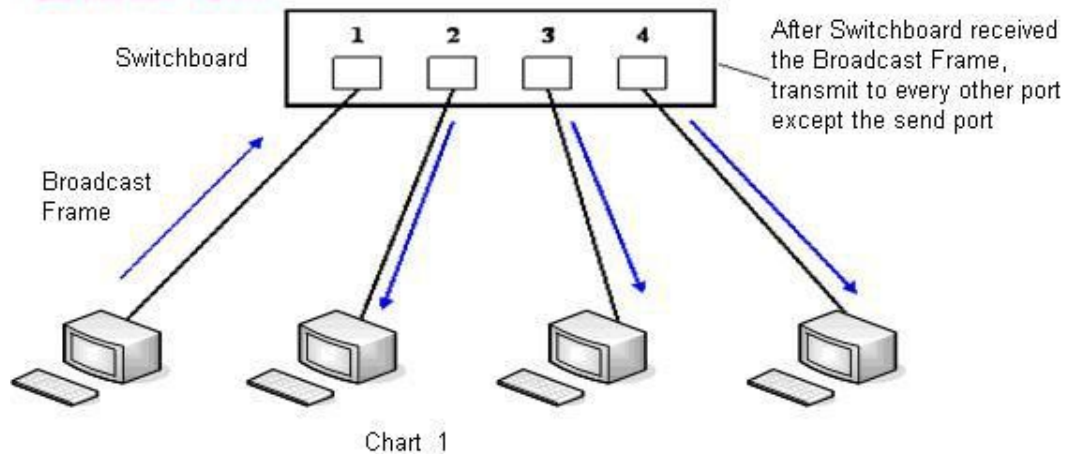

Use VLAN

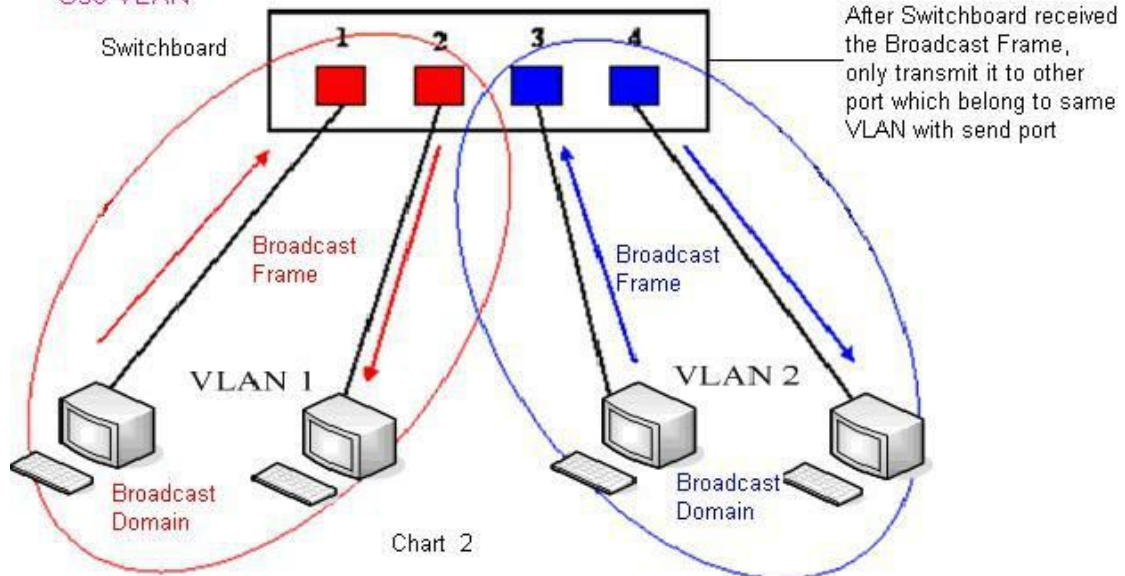

In chart 1, there is a layer 2 that switches without setting VLAN. Any broadcast frame will be transmitted to the other ports except the send port. For example, a broadcast information is sent out from port 1 then transmitted to port 2,3 and 4. In chart 2, red and blue indicate two different VLANs in the switch, and port 1 and port 2 belong to red VLAN, port 3 and port 4 belong to blue VLAN. If a broadcast frame is sent out from port 1, switch will transmit it to port 2, the

other port in the red VLAN and not transmit it to port3 and port 4 in blue VLAN. By this means, VLAN divide the broadcast domain via restricting the range of broadcast frame transition.

Note: chart 2 use red and blue to identify the different VLAN, but in practice, VLAN uses different VLAN IDs to identify.

The screenshot shows a configuration page with a dark red header containing tabs for WAN, LAN, QoS, SERVICE PORT, DHCP SERVER, and SNTP. The QoS tab is active. Below the header, the page title is 'QoS Set'. The configuration area includes several options: 'VLAN ID Check Enable' (checked), 'DiffServ Enable' (checked), 'Voice 802.1P Priority' (0), 'Voice VLAN ID' (256), 'Enable Port Vlan' (checked), 'VLAN Enable' (checked), 'Voice/Data VLAN differentiated' (Undifferentiated), 'DiffServ Value' (0x b8), 'Data 802.1P Priority' (0), and 'Data VLAN ID' (254). An 'APPLY' button is located at the bottom center.

## QoS Configuration

Field name	explanation
VLAN Enable	Before select it to enable VLAN, you need enable Bridge mode in LAN config.
VLAN ID Check Enable	Enable VLAN ID check by selecting it. After enable VLAN ID check, if VLAN ID of a data package is not the same with the phones or a data package do not have VLAN ID, the data package will be discarded.
Voice/Data VLAN differentiated	After enable VLAN, system will set packets with different type of VLAN ID. Undifferentiated means after using VLAN, both VoIP packets and other data packets will use the voice VLAN ID; tag differentiated means after using VLAN, VoIP(signal and voice) packets will add voice VLAN ID, and other data packets will add data VLAN ID; data untagged means after using VLAN, only VoIP packets will add voice VLAN ID. Other data packets will not use VLAN.
DiffServ Enable	Select it or not to Enable or disable DiffServ.
DiffServ Value	Set DiffServ value, the common value is 0x00.
Voice 802.1P Priority	Specify 802.1P Priority of voice/signal data package.
Data 802.1P Priority	Set 802.1p of data VLAN. Non-VoIP data (such as http, telnet, ping etc) will use this value to set VLAN package.
Voice VLAN ID	Set VLAN ID of voice/signal data package.
Data VLAN ID	Set 802.1q of data VLAN ID. Non-VoIP data (such as http, telnet, ping etc) will use this value to set VLAN

package.

### 7.3.2.4 Service Port

You can set the port of telnet/HTTP/RTP by this page.

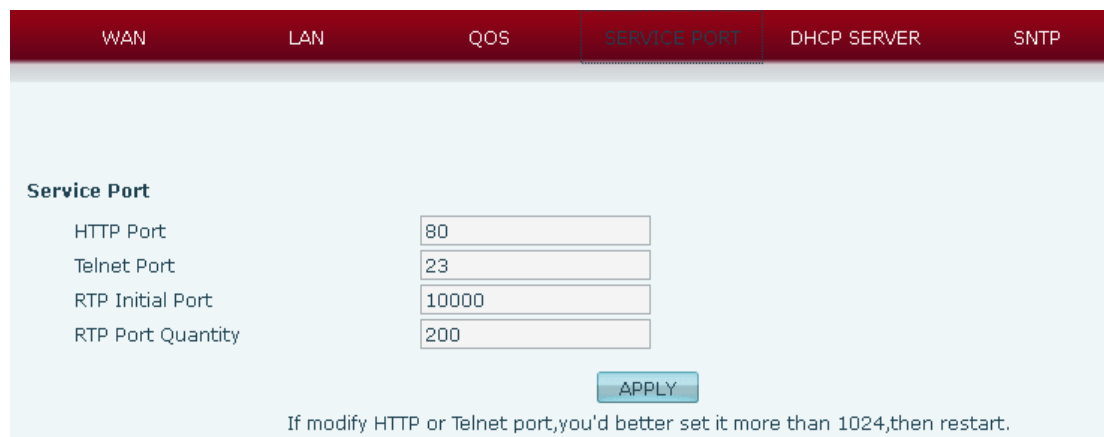

Service Port

HTTP Port: 80

Telnet Port: 23

RTP Initial Port: 10000

RTP Port Quantity: 200

APPLY

If modify HTTP or Telnet port, you'd better set it more than 1024, then restart.

## SERVICE PORT

Field name	explanation
HTTP Port	set web browser port, the default is 80 port, if you want to enhance system safety, you'd better change it into non-80 standard port; Example: The IP address is 192.168.1.70. and the port value is 8090, the accessing address is http://192.168.1.70:8090
Telnet Port	Set Telnet Port, the default is 23. You can change the value into others. Example: The IP address is 192.168.1.70. the telnet port value is 8023, the accessing address is telnet 192.168.1.70 8023
RTP Initial Port	Set the RTP Initial Port. It is dynamic allocation.
RTP Port Quantity	Set the maximum quantity of RTP Port, the default is 200.

#### Notice:

- 1) You need save the configuration and reboot the phone after set this page.
- 2) If you modify the port of Telnet and HTTP, you would better set the value more than 1024 because the port value less than 1024 is system port reserved.
- 3) If you set 0 for the HTTP port, it will disable HTTP service.

## 7.3.2.5 DHCP SERVER

WAN
LAN
QOS
SERVICE PORT
DHCP SERVER
SNTP

**DHCP Leased Table**

Leased IP Address	Client Hardware Address

**DHCP Lease Table**

Name	Start IP	End IP	Lease Time	Netmask	Gateway	DNS
lan	192.168.10.1	192.168.10.30	1440	255.255.255.0	192.168.10.1	192.168.10.1

**DHCP Lease Table Setting**

Lease Table Name

Start IP

End IP

Lease Time  (minute)

Netmask

Gateway

DNS

**DHCP Lease Table Delete**

Lease Table Name lan ▾

**DNS relay Setting**

DNS Relay

## DHCP SERVER

Field name	explanation
DHCP Leased Table	IP-MAC mapping table. If the LAN port of the phone connects to a device, this table will show the IP and MAC address of this device.

DHCP Lease Table						
Name	Start IP	End IP	Lease Time	Netmask	Gateway	DNS
lan	192.168.10.1	192.168.10.30	1440	255.255.255.0	192.168.10.1	192.168.10.1

Shows the DHCP Lease Table, the unit of Lease time is Minute.

Lease Table Name	Specify the name of the lease table
Start IP	Set the start IP address of the lease table
End IP	Set the end IP address of the lease table, the network device connected to LAN port will get IP address between Start IP and End IP by DHCP.
Netmask	Set the Netmask of the lease table
Gateway	Set the Gateway of the lease table
Lease Time	Set the Lease Time of the lease table

DNS Set the default DNS server IP of the lease table; Click the **Add** button to submit and add this lease table

---

**DHCP Lease Table Delete**

Lease Table Name

---

Select name of lease table, click the **Delete** button will delete the selected lease table from DHCP lease table.

---

DNS Relay Select DNS Relay, the default is enabled. Click the **Apply** button to become effective.

---

**Notice:**

- 1) The size of lease table cannot be larger than the quantity of C network IP address. We recommend you to use the default lease table and not modify it.
  - 2) If you modify the DHCP lease table, you need save the configuration and reboot.
- 

### 7.3.2.6 SNTP

Setting time zone and SNTP (Simple Network Time Protocol) server according to your location, you can also manually adjust date and time in this web page.



WAN	LAN	QOS	SERVICE PORT	DHCP SERVER	SNTTP
<b>SNTTP Time Set</b>					
Main Server	<input type="text" value="209.81.9.7"/>				
BackUp Server	<input type="text"/>				
Time Zone	<input type="text" value="(GMT+08:00)Beijing,Chongqing,Hong Kong,Urumqi"/>				
Time Out	<input type="text" value="60"/>	(seconds)			
12 Hours Systems	<input type="checkbox"/>				
SNTTP	<input checked="" type="checkbox"/>				
Date Format	<input type="text" value="YYYY MM DD"/>				
Date Seperator	<input type="text" value="/"/>				
<input type="button" value="APPLY"/>					
<b>Daylight Timeset</b>					
Enable Daylight	<input type="checkbox"/>				
Time shift (minutes)	<input type="text" value="60"/>				
Time Zone	Start Date		End Date		
Month	<input type="text" value="March"/>		<input type="text" value="October"/>		
Week	<input type="text" value="5"/>		<input type="text" value="5"/>		
Day	<input type="text" value="Sunday"/>		<input type="text" value="Sunday"/>		
Hour	<input type="text" value="2"/>		<input type="text" value="2"/>		
Minute	<input type="text" value="0"/>		<input type="text" value="0"/>		
<input type="button" value="APPLY"/>					
<b>Manual Timeset</b>					
Year	<input type="text"/>				
Months	<input type="text"/>				
Day	<input type="text"/>				
Hour	<input type="text"/>				
Minute	<input type="text"/>				
<input type="button" value="APPLY"/>					

## SNTTP

Field name	explanation
Server	Set SNTTP Server IP address.
Time Zone	Select the Time zone according to your location.
Time Out	Set the time out, the default is 60 seconds.
12 Hours Systems	Switch the time mechanism between 12 hours and 24 hours. Default is 24 hours mode.
SNTTP	Select the SNTTP, and click Apply to make the SNTTP Times effective.
Enable Daylight	Enable daylight saving time
Time shift(minutes)	Setup the variety length
Month	Setup stat and end month
Week	Setup start and end week
Day	Setup start and end day
Hour	Setup start and end hours

---

Minute

---

Setup start and end minutes

---

Year	<input type="text"/>
Months	<input type="text"/>
Day	<input type="text"/>
Hour	<input type="text"/>
Minute	<input type="text"/>

---

Notice: You need specify the above all items.

---

## 7.3.3 VOIP

### 7.3.3.1 SIP Config

Set your SIP server in the following interface.

SIP	IAX2	STUN	DIAL PEER
-----	------	------	-----------

---

**SIP Line Select**

---

**Basic Setting**

Register Status	Registered	Display Name	<input type="text"/>
Server Name	<input type="text"/>	Proxy Server Address	<input type="text"/>
Server Address	192.168.1.2	Proxy Server Port	<input type="text"/>
Server Port	5060	Proxy Username	<input type="text"/>
Account Name	<input type="text"/>	Proxy Password	<input type="text"/>
Password	<input type="text"/>	Domain Realm	<input type="text"/>
Phone Number	<input type="text"/>	Enable Register	<input checked="" type="checkbox"/>

Advanced Set

---

**Advanced SIP Setting**

Register Expire Time	<input type="text" value="60"/> seconds	Forward Type	<input type="text" value="Off"/>
NAT Keep Alive Interval	<input type="text" value="60"/> seconds	Forward Phone Number	<input type="text"/>
User Agent	<input type="text" value="Voip Phone 1.0"/>	Server Type	<input type="text" value="COMMON"/>
Signal Key	<input type="text"/>	DTMF Mode	<input type="text" value="DTMF_RFC2833"/>
Media Key	<input type="text"/>	RFC Protocol Edition	<input type="text" value="RFC3261"/>
Local Port	<input type="text" value="5060"/>	Transport Protocol	<input type="text" value="UDP"/>
Ring Type	<input type="text" value="Default"/>	RFC Privacy Edition	<input type="text" value="NONE"/>
Hot Line Number	<input type="text"/>	Subscribe Expire Time	<input type="text" value="300"/> seconds
Enable HotLine	<input type="checkbox"/>	WarmLine Time	<input type="text" value="0"/> (0-9)seconds
Conference Number	<input type="text"/>	Enable Conference Number	<input type="checkbox"/>
Transfer Expire Time	<input type="text" value="0"/> seconds	MWI Number	<input type="text"/>
Click To Talk	<input type="checkbox"/>	Subscribe for MWI	<input type="checkbox"/>
Enable Keep Authentication	<input type="checkbox"/>	Signal Encode	<input type="checkbox"/>
NAT Keep Alive	<input type="checkbox"/>	Rtp Encode	<input type="checkbox"/>
Enable Via rport	<input type="checkbox"/>	Enable Session Timer	<input type="checkbox"/>
Enable PRACK	<input type="checkbox"/>	Answer With Single Codec	<input type="checkbox"/>
Long Contact	<input type="checkbox"/>	Auto TCP	<input type="checkbox"/>
Enable URI Convert	<input checked="" type="checkbox"/>	Enable Strict Proxy	<input type="checkbox"/>
Dial Without Register	<input type="checkbox"/>	Enable GRUU	<input type="checkbox"/>
Ban Anonymous Call	<input type="checkbox"/>	Enable Displayname Quote	<input type="checkbox"/>
Enable DNS SRV	<input type="checkbox"/>	Enable user=phone	<input checked="" type="checkbox"/>
Enable Missed Call Log	<input checked="" type="checkbox"/>		

**Codecs**

<p>Disable codecs</p> <div style="border: 1px solid #ccc; padding: 5px; min-height: 100px;"> G711A  G711U  G722  G723  G726-32  G729  AMR </div>	<input type="button" value="→"/> <input type="button" value="←"/>	<p>Enable codecs</p> <div style="border: 1px solid #ccc; padding: 5px; min-height: 100px;"> </div>	<input type="button" value="↑"/> <input type="button" value="↓"/>
<input type="button" value="APPLY"/>			

## SIP Config

Field name	explanation
<p><b>SIP Line Select</b></p> <div style="display: flex; justify-content: space-between; align-items: center;"> <div style="border: 1px solid #ccc; padding: 2px 5px;">SIP 1 ▾</div> <div style="border: 1px solid #ccc; padding: 2px 10px; background-color: #e0e0e0;">Load</div> </div>	

Choose line to set info about SIP, there are 3 lines to choose. You can switch by **【Load】** button.

Register Status	Shows if the phone has been registered the SIP server or not; or so, show Unapplied.
Server Name	Set the server name.
Server Address	Input your SIP server address.
Server Port	Set your SIP server port.
Account Name	Input your SIP register account name.

Password	Input your SIP register password.
Phone Number	Input the phone number assigned by your VoIP service provider. Phone will not register if there is no phone number configured.
Display Name	Set the display name.
Proxy Server Address	Set proxy server IP address (Usually, Register SIP Server configuration is the same as Proxy SIP Server. But if your VoIP service provider give different configurations between Register SIP Server and Proxy SIP Server, you need make different settings.)
Proxy Server Port	Set your Proxy SIP server port.
Proxy Username	Input your Proxy SIP server account.
Proxy Password	Input your Proxy SIP server password.
Domain Realm	Set the sip domain if needed, otherwise this VoIP phone will use the Register server address as sip domain automatically. (Usually it is same with registered server and proxy server IP address).
Enable Register	Start to register or not by selecting it or not.
Register Expire Time	Set expire time of SIP server register, default is 60 seconds. If the register time of the server requested is longer or shorter than the expire time set, the phone will change automatically the time into the time recommended by the server, and register again.
NAT Keep Alive Interval	Set examining interval of the server, default is 60 seconds
User Agent	Set the user agent if have, the default is VoIP Phone 1.0
Signal Key	Set the key for signal encryption
Media Key	Set the key for RTP encryption
Local port	Set sip port of each line
Ring type	Set ring type of each line
Hot line Number	Set hot line number of each line
Conference Number	Configure conference number in server conference.
Transfer Expire Time	For the phone supports the transfer of certain special features server, set interval time between sending "bye" and hanging up after the phone transfers a call.
Enable subscribe	Enable the option ,the phone will receive the notify from the server.
Enable Keep Authentication	Enable/Disable Keep Authentication System will take the last authentication field which is passed the

authentication by server to the request packet. It will decrease the server's repeat authorization work, if it is enable.

NAT Keep Alive	<p>Enable/Disable keeps NAT of SIP alive.</p> <p>If some server refuse to register with too short interval time, and has no packets sending to device in private network to keep NAT alive, user could set this function ON. It need set the keep alive interval time less than the NAT server's.</p>
Enable Via rport	<p>Enable/Disable system to support RFC3581. Via rport is special way to realize SIP NAT.</p>
Enable PRACK	<p>Enable or disable SIP PRACK function, suggest use the default config.</p>
Long Contact	<p>Set more parameters in contact field; connection with SEM server</p>
Enable URI Convert	<p>Convert # to %23 when send the URI.</p>
Dial Without Register	<p>Set call out by proxy without registration;</p>
Ban Anonymous Call	<p>Set to ban Anonymous Call;</p>
Enable DNS SRV	<p>Support DNS looking up with sip.udp mode</p>
Forward Type	<p>Select call forward mode, the default is Off</p> <p>Off: Close down calling forward</p> <p>Busy: If the phone is busy, incoming calls will be forwarded to the appointed phone.</p> <p>No answer: If there is no answer, incoming calls will be forwarded to the appointed phone.</p> <p>Always: Incoming calls will be forwarded to the appoint phone directly. The phone will Prompt the incoming while doing forward.</p>
Forward Phone Number	<p>Appoint your forward phone number.</p>
Server Type	<p>Select the special type of server which is encrypted, or has some unique requirements or call flows.</p>
DTMF Mode	<p>Select DTMF sending mode, there are three modes:</p> <ul style="list-style-type: none"> <li>● DTMF_RELAY</li> <li>● DTMF_RFC2833</li> <li>● DTMF_SIP_INFO</li> </ul> <p>Different VoIP Service providers may provide different modes.</p>
	<p>Select SIP protocol version to adapt for the SIP</p>

RFC Protocol Edition	server which uses the same version as you select. For example, if the server is CISCO5300, you need to change to RFC2543, else phone may not cancel call normally. System uses RFC3261 as default.
Transport Protocol	Set transport protocols, TCP or UDP;
RFC Privacy Edition	Set Anonymous call out safely; Support RFC3323and RFC3325;
Subscribe Expire Time	Overtime of resending subscribe packet. Suggest using the default config.
Enable Conference number	Set to use sever conference.
MWI Number	Input the number of the server's voice-mail box
Click to Talk	Set click to Talk (need practical software support).
Signal Encode	Enable/Disable Signal Encrypt.
RTP Encode	Enable/Disable RTP Encrypt.
Enable Session Timer	Set Enable/Disable Session Timer, whether support RFC4028.It will refresh the SIP sessions.
Answer With Single Codec	Enable/Disable the function when call is incoming, phone replies SIP message with just one codec which phone supports.
Auto TCP	Set to use automatically TCP protocol to guarantee usability of transport as message is above 1300 byte
Enable Strict Proxy	Support the special SIP server-when phone receives the packets sent from server, phone will use the source IP address, not the address in via field.
Enable GRUU	Set to support GRUU
Enable Display name Quote	Set to make quotation mark to display name as the phone sends out signal, in order to be compatible with server.
codecs	You may set up different codecs for every SIP line. If there is no codecs list in a SIP line, system would use the DSP codecs list.

### 7.3.3.2 IAX2 Config

**IAX2**

Register Status Unapplied

IAX2 Server Addr

IAX2 Server Port

Account Name

Account Password

Phone Number

Local Port

Voice Mail Number

Voice Mail Text

Echo Test Number

Echo Test Text

Refresh Time  Seconds

Enable Register

Enable G.729

### IAX2 Config

Field name	explanation
Register Status	Shows if the phone has been registered the IAX2 server or not.
IAX2 Server Addr	Input your IAX2 server address.
IAX2 Server Port	Set your IAX2 server port, the default is 4569.
Account Name	Input your IAX2 register account name.
Account Password	Input your IAX2 register password.
Phone Number	Input your assigned phone number (usually it is same you're your IAX2 account name).
Local Port	Set your local sport, the default is 4569.
Voice Mail Number	Specify the voice mail's number.

Voice Mail Text	Specify the voice mail's name.
Echo Test Number	Set echo test number. If IAX2 server supports echo test, and echo test number is non-numeric, system could set an echo test number to replace the echo test text. So user can dial the numeric number to test echo voice test. This function is provided with server to make endpoint to test whether endpoint could talk through server normally.
Echo Test Text	Specify echo test text's name.
Refresh Time	Set expire time of IAX2 server register, you can set it between 60 and 3600 seconds.
Enable Register	Start to register the IAX2 server or not by selecting it or not.
Enable G.729	Enable or disable code G.729 by selecting it or not

### 7.3.3.3 Stun Config

In this web page, you can config SIP STUN.

STUN: By STUN server, the phone in private network could know the type of NAT and the NAT mapping IP and port of SIP. The phone might register itself to SIP server with global IP and port to realize the device both calling and being called in private network.

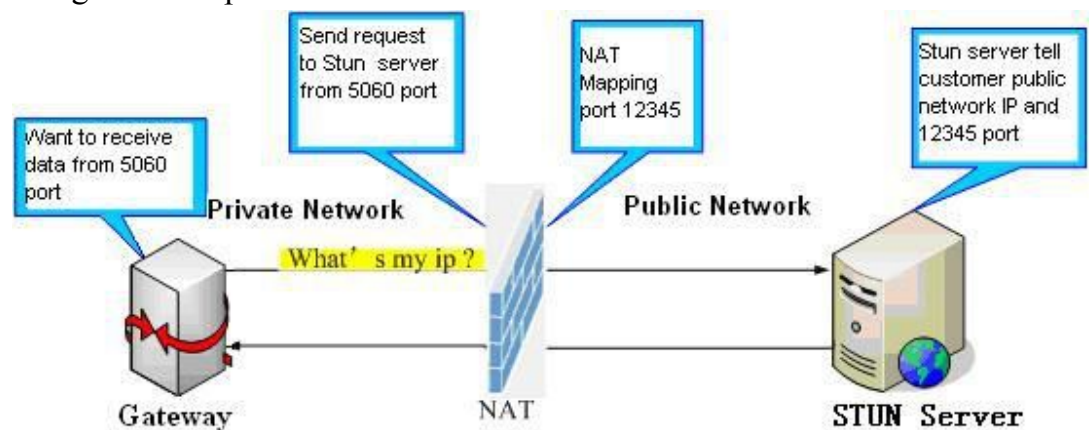



SIP	IAX2	STUN	DIAL PEER
<b>STUN Set</b>			
STUN NAT Transverse		FALSE	
STUN Server Addr		<input type="text"/>	
STUN Server Port		3478	
STUN Effect Time		50	Seconds
Local SIP Port		5060	
<input type="button" value="APPLY"/>			
<b>Set Sip Line Enable STUN</b>			
<input type="text" value="SIP 1"/>		<input type="button" value="Load"/>	
Use STUN		<input type="checkbox"/>	
<input type="button" value="APPLY"/>			

## STUN

Field name	explanation
STUN NAT Transverse	Shows STUN NAT Transverse estimation, true means STUN can penetrate NAT, while False means not.
STUN Server Addr	Set your SIP STUN Server IP address
STUN Server Port	Set your SIP STUN Server Port
STUN Effect Time	Set STUN Effective Time. If NAT server finds that a NAT mapping is idle after time out, it will release the mapping and the system need send a STUN packet to keep the mapping effective and alive.
Local SIP Port	Set the SIP port.

<b>Set Sip Line Enable STUN</b>			
<input type="text" value="SIP 1"/>		<input type="button" value="Load"/>	
Use STUN		<input type="checkbox"/>	
<input type="button" value="APPLY"/>			

Choose line to set info about SIP, There are 3 lines to choose. You can switch by **【Load】** button.

Use Stun                      Enable/Disable SIP STUN.

**Notice:** SIP STUN is used to realize SIP penetration to NAT. If your phone configures STUN Server IP and Port (default is 3478), and enable SIP Stun, you can use the ordinary SIP Server to realize penetration to NAT.

### 7.3.3.4 DIAL PEER setting

This functionality offers you more flexible dial rule, you can refer to the following content to know how to use this dial rule. When you want to dial an IP address, the entry of IP addresses is very cumbersome, but by this functionality, you can set number 156 to replace 192.168.1.119 here.

Dial Peer Table							
Number	Destination	Port	Mode	Alias	Suffix	Del Length	
156	192.168.1.119	5060	SIP	no alias	no suffix	0	

When you want to dial a long distance call to Beijing, you need dial an area code 010 before local phone number, but you can also dial number 1 instead of 010 after we make a setting according to this dial rule. For example, you want to dial 01062213123, but you need dial only 162213123 to realize your long distance call after you make this setting.

Dial Peer Table							
Number	Destination	Port	Mode	Alias	Suffix	Del Length	
1T	0.0.0.0	5060	SIP	rep:010	no suffix	1	

To save the memory and avoid abundant input of user, add the follow functions:

Dial Peer Table							
Number	Destination	Port	Mode	Alias	Suffix	Del Length	
13*****	0.0.0.0	5060	SIP	add:0	no suffix	0	
13[5-9]*****	0.0.0.0	5060	SIP	add:0	no suffix	0	

1.\* Match any single digit that is dialed.

If user makes the above configuration, after user dials 11 digit numbers started with 13, the phone will send out 0 plus the dialed numbers automatically.

2. [] Specifies a range that will match digit. It may be a range, a list of ranges separated by commas, or a list of digits.

If user makes the above configuration, after user dials 11 digit numbers started with from 135 to 139, the phone will send out 0 plus the dialed numbers automatically.

Use this phone you can realize dialing out via different lines without switch in web interface.

SIP	IAX2	STUN	DIAL PEER
-----	------	------	-----------

**Dial Peer Table**

Number	Destination	Port	Mode	Alias	Suffix	Del Length
13*****	0.0.0.0	5060	SIP	add:0	no suffix	0
13[5-9]*****	0.0.0.0	5060	SIP	add:0	no suffix	0
156	192.168.1.119	5060	SIP	no alias	no suffix	0
1T	0.0.0.0	5060	SIP	add:0	no suffix	0

**Add Dial Peer**

Phone Number

Destination (optional)

Port(optional)

Alias(optional)

Call Mode

Suffix(optional)

Delete Length (optional)

**Dial Peer Option**

## DIAL PEER



Field name	explanation
Phone number	There are two types of matching conditions: one is full matching, the other is prefix matching. In the Full matching, you need input your desired phone number in this blank, and then you need dial the phone number to realize calling to what the phone number is mapped. In the prefix matching, you need input your desired prefix number and T; then dial the prefix and a phone number to realize calling to what your prefix number is mapped. The prefix number supports at most 30 digits
Destination	Set Destination address. This is optional config item. If you want to set peer to peer call, please input destination IP address or domain name. If you want to use this dial rule on SIP2 line, you need input 255.255.255.255 or 0.0.0.2 in it.SIP3 into 0.0.0.3
Port	Set the Signal port, the default is 5060 for SIP.
Alias	Set alias. This is optional config item. If you don't set Alias, it will show no alias.
<p>Note: There are four types of aliases.</p> <p>1) Add: xxx, it means that you need dial xxx in front of phone number, which will reduce dialing number length.</p> <p>2) All: xxx, it means that xxx will replace some phone number.</p> <p>3) Del: It means that phone will delete the number with length appointed.</p>	

4) Rep: It means that phone will replace the number with length and number appointed.

You can refer to the following examples of different alias application to know more how to use different aliases and this dial rule.

Call Mode	Select different signal protocol, SIP or IAX2
Suffix	Set suffix, this is optional config item. It will show no suffix if you don't set it.
Delete Length	Set delete length. This is optional config item. For example: if the delete length is 3, the phone will delete the first 3 digits then send out the rest digits. You can refer to examples of different alias application to know how to set delete length.

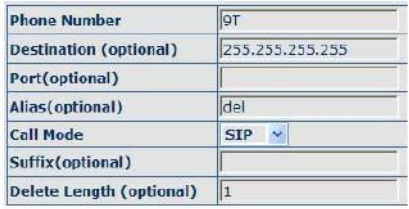
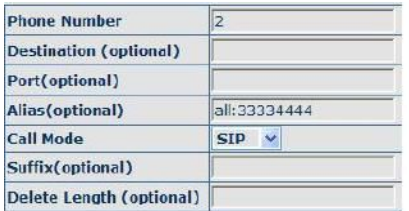
### Examples of different alias application

Set by web	explanation	example
	<p>You need set phone number, Destination, Alias and Delete Length. Phone number is XXXT; Destination is 255.255.255.255 (0.0.0.2) and Alias is del.</p> <p>This means any phone No. that starts with your set phone number will be sent via SIP2 line after the first several digits of your dialed phone number are deleted according to delete length.</p>	<p>If you dial "93333", the SIP2 server will receive "3333"</p>
	<p>This setting will realize speed dial function, after you dialing the numeric key "2", the number after all will be sent out.</p>	<p>When you dial "2", the SIP1 server will receive 33334444</p>
	<p>The phone will automatically send out alias number adding your dialed number, if your dialed number starts with your set phone number.</p>	<p>When you dial "8309", the SIP1 server will receive "07558309"</p>

<table border="1"> <tr><td>Phone Number</td><td>010T</td></tr> <tr><td>Destination (optional)</td><td></td></tr> <tr><td>Port(optional)</td><td></td></tr> <tr><td>Alias(optional)</td><td>rep:0086</td></tr> <tr><td>Call Mode</td><td>SIP</td></tr> <tr><td>Suffix(optional)</td><td></td></tr> <tr><td>Delete Length (optional)</td><td>3</td></tr> </table>	Phone Number	010T	Destination (optional)		Port(optional)		Alias(optional)	rep:0086	Call Mode	SIP	Suffix(optional)		Delete Length (optional)	3	<p>You need set Phone Number, Alias and Delete Length. Phone number is XXXT and Alias is rep: xxx</p> <p>If your dialed phone number starts with your set phone number, the first digits same as your set phone number will be replaced by the alias number specified and New phone number will be send out.</p>	<p>When you dial “0106228”, the SIP1 server will receive “86106228”</p>
Phone Number	010T															
Destination (optional)																
Port(optional)																
Alias(optional)	rep:0086															
Call Mode	SIP															
Suffix(optional)																
Delete Length (optional)	3															
<table border="1"> <tr><td>Phone Number</td><td>147</td></tr> <tr><td>Destination (optional)</td><td></td></tr> <tr><td>Port(optional)</td><td></td></tr> <tr><td>Alias(optional)</td><td></td></tr> <tr><td>Call Mode</td><td>SIP</td></tr> <tr><td>Suffix(optional)</td><td>0011</td></tr> <tr><td>Delete Length (optional)</td><td></td></tr> </table>	Phone Number	147	Destination (optional)		Port(optional)		Alias(optional)		Call Mode	SIP	Suffix(optional)	0011	Delete Length (optional)		<p>If your dialed phone number starts with your set phone number. The phone will send out your dialed phone number adding suffix number.</p>	<p>When you dial “147”, the SIP1 server will receive “1470011”</p>
Phone Number	147															
Destination (optional)																
Port(optional)																
Alias(optional)																
Call Mode	SIP															
Suffix(optional)	0011															
Delete Length (optional)																

## 7.3.4 Phone

### 7.3.4.1 DSP Config

In this page, you can configure voice codec, input/output volume and so on.

DSP	CALL SERVICE	DIGITAL MAP	PHONE BOOK	REMOTE PBOOK	WEB DIAL
-----	--------------	-------------	------------	--------------	----------

**DSP Configuration**

First Codec	<input type="text" value="g711Ulaw64k"/>	Second Codec	<input type="text" value="g711Alaw64k"/>
Third Codec	<input type="text" value="g729"/>	Fourth Codec	<input type="text" value="g723"/>
Fifth Codec	<input type="text" value="g726-32"/>	Sixth Codec	<input type="text" value="g722"/>
Seventh Codec	<input type="text" value="AMR"/>	AMR Payload Type	<input type="text" value="108"/> (96-127)
Handdown Time	<input type="text" value="200"/> ms	Default Ring Type	<input type="text" value="Type 1"/>
Input Volume	<input type="text" value="3"/> (1-9)	Output Volume	<input type="text" value="5"/> (1-9)
Handfree Volume	<input type="text" value="5"/> (1-9)	Ring Volume	<input type="text" value="5"/> (1-9)
G729 Payload Length	<input type="text" value="20ms"/>	Signal Standard	<input type="text" value="China"/>
G722 Timestamps	<input type="text" value="160/20ms"/>	G723 Bit Rate	<input type="text" value="6.3kb/s"/>
VAD	<input type="checkbox"/>	Dtmf Payload Type	<input type="text" value="101"/> (96-127)

## DSP Configuration

Field name	explanation
First Codec	The first preferential DSP codec: G.711A/u, G.722, G.723, G.729, G.726, AMR
Second Codec	The second preferential DSP codec: G.711A/u, G.722, G.723, G.729, G.726, AMR
Third Codec	The third preferential DSP codec: G.711A/u, G.722, G.723, G.729, G.726, AMR
Fourth Codec	The fourth preferential DSP codec: G.711A/u, G.722, G.723, G.729, G.726, AMR
Fifth Codec	The fifth preferential DSP codec: G.711A/u, G.722, G.723, G.729, G.726, AMR
Sixth Codec	The fifth preferential DSP codec: G.711A/u, G.722, G.723, G.729, G.726, AMR
Seventh Codec	The fifth preferential DSP codec: G.711A/u, G.722, G.723, G.729, G.726, AMR
Input Volume	Specify Input (MIC) Volume grade.;
Hands-free Volume	Specify Hands-free Volume grade
G729 Payload Length	Set G729 Payload Length
AMR payload type	Set AMR payload type
Hand down Time	Specify the least reflection time of Hand down, the default is 200ms.
Ring Type	Select Ring Type
Output Volume	Specify Output (receiver) Volume grade.
Ring Volume	Specify Ring Volume grade
G722 Timestamps	160/20ms or 320/20ms is available
G723 Bit Rate	5.3kb/s or 6.3kb/s is available
Default Ring Type	Set up the ring by default
Signal Standard	Select Signal Standard.
VAD	Select it or not to enable or disable VAD. If enable VAD, G729 Payload length could not be set over 20ms.

### 7.3.4.2 Call Service

In this web page, you can configure Hotline, Call Transfer, Call Waiting, 3 Ways Call, Black List, white list Limit List and so on.

DSP    CALL SERVICE    DIGITAL MAP    PHONE BOOK    REMOTE PBOOK    WEB DIAL

---

**Call Service Setting**

Hot Line	<input type="text"/>	No Answer Time	<input type="text" value="20"/> (seconds)
P2P IP Prefix	<input type="text" value="."/>	Auto Answer	<input type="checkbox"/>
Do Not Disturb	<input checked="" type="checkbox"/>	Ban Outgoing	<input checked="" type="checkbox"/>
Enable Call Transfer	<input checked="" type="checkbox"/>	Enable Call Waiting	<input checked="" type="checkbox"/>
Enable Three Way Call	<input checked="" type="checkbox"/>	Accept Any Call	<input checked="" type="checkbox"/>
Auto Handdown	<input checked="" type="checkbox"/>	Auto Handdown Time	<input type="text" value="3"/> (seconds)
Enable Auto Redial	<input type="checkbox"/>	Enable Call Completion	<input type="checkbox"/>
Mute Mode	<input type="checkbox"/>	Ring From Headset	<input type="checkbox"/>
Intercom Mode	<input checked="" type="checkbox"/>	Intercom Mute	<input type="checkbox"/>
Intercom Tone	<input checked="" type="checkbox"/>	Intercom Barge	<input checked="" type="checkbox"/>
Warm Line Time	<input type="text" value="0"/> (0-9s)	DND Return Code	480(Temporarily not available) ▾
Reject Return Code	603(Decline) ▾	Busy Return Code	486(Busy here) ▾
Emergency Call Number	<input type="text" value="110"/>		

---

**Black List**

Black List

▾

---

**Limit List**

Limit List

▾

## Call Service

Field name	explanation
Hotline	Specify Hotline number. If you set the number, you cannot dial any other numbers.
No Answer Time	Specify No Answer Time
P2P IP Prefix	Set Prefix in peer to peer IP call. For example: what you want to dial is 192.168.1.119, If you define P2P IP Prefix as 192.168.1., you dial only #119 to reach 192.168.1.119. Default is ".". If there is no "." Set, it means to disable dialing IP.
Do Not Disturb	Select NO Disturb, the phone will reject any incoming call, the callers will be reminded by busy, but any outgoing call from the phone will work well.
Ban Outgoing	If you select Ban Outgoing to enable it, and you cannot dial out any number.
Enable Call Transfer	Enable Call Transfer by selecting it.
Enable Call Waiting	Enable Call Waiting by selecting it.
Enable Three Way Call	Enable Three Way Call

Accept Any Call	If select it, the phone will accept the call even if the called number is not belong to the phone.
Auto handdown	Enable the phone to auto hang up a call after the call is finished
Auto handdown time	Set the auto handdown time. System would play the busy tone and then hang up automatically
Enable auto redial	Enable system to redial a call automatically
Enable call completion	Enable system to redial a call via SIP automatically.
Auto Answer	If select it, the phone will auto answer when there is an incoming call.
Mute mode	Enable system without ring play
Ring from headset	Set up ring play via headset if a headset is inserted to a phone
Intercom mode	Enable system call with intercom mode
Intercom mute	Enable the intercom answering party with mute
Intercom tone	Enable the intercom answering party answer immediately even if it is talking
Intercom barge	Enable the intercom answering party ring and then answer it.
Warm line time	Set up warm line time
DND return code	Set up SIP response code for DND
Reject return code	Set up SIP response code for reject
Busy return code	Set up SIP response code for busy
Imergency call number	Set up an available called number if keylock is enabled
	Set Add/Delete Black list. If user does not want to answer some phone calls, add these phone numbers to the Black List, and these calls will be rejected. x and are wildcard x means matching any single digit. for example, 4xxx expresses any number with prefix 4 which length is 4 will be forbidden to be responded.
Black List	DOT (.) means matching any arbitrary number digit. for example, 6. expresses any number with prefix 6 will be



forbidden to be responded.

If user wants to allow a number or a series of number incoming, he may add the number(s) to the list as the white list rule. the configuration rule is -number, for example, -123456, or -1234xx

Black List
-4119
.

Means any incoming number is forbidden except for 4119

Note: End with DOT (.) when set up the white list

Limit List

Set Add/Delete Limit List. Please input the prefix of those phone numbers which you forbid the phone to dial out. For example, if you want to forbid those phones of 001 as prefix to be dialed out, you need input 001 in the blank of limit list, and then you cannot dial out any phone number whose prefix is 001.

X and are wildcard x means matching any single digit. For example, 4xxx expresses any number with prefix 4 which length is 4 will be forbidden to dialed out means matching any arbitrary number digit. For example, 6 expresses any number with prefix 6 will be forbidden to dialed out.

Notice: Black List and Limit List can record at most 10 items respectively.

### 7.3.4.3 Digital Map Configuration

This system supports 4 dial modes:

- 1) End with “#”: dial your desired number, and then press #.
- 2) Fixed Length: the phone will intersect the number according to your specified length.
- 3) Time Out: After you stop dialing and waiting time out, system will send the number collected.
- 4) User defined: you can customize digital map rules to make dialing more flexible. It is realized by defining the prefix of phone number and number length of dialing.

In order to keep some users' secondary dialing manner when dialing the external line with PBX, phone can be added a special rule to realize it. so user can dial a number as external line prefix and get the secondary dial tone to keep dial the external number. After finishing dialing, phone will send the prefix and external number totally to the server.

For example, there is a rule 9, xxxxxxxx in the digital map table. After dialing 9, phone will send the secondary dial tone, user may keep going dialing. After finished, phone will call the number which starts with 9; actually the number

sent out is 9-digit with 9.

## Digital Map Configuration

Field name	explanation
End with "#"	Set Enable/Disable the phone ended with “#” dial.
Fixed Length	Specify the Fixed Length of phone ending with.
Time out	Set the timeout of the last dial digit. The call will be sent after timeout.

Below is user-defined digital map rule:

[] Specifies a range that will match digit. May be a range, a list of ranges separated by commas, or a list of digits.

\* Match any single digit that is dialed.

. Match any arbitrary number of digits including none.

Tn Indicates an additional time out period before digits are sent of n seconds in length. n is mandatory and can have a value of 0 to 9 seconds. Tn must be the last 2 characters of a dial plan. If Tn is not specified it is assumed to be T0 by default on all dial plans.

RULE
"[1-8]xxx"
"9xxxxxxxx"
"911"
"99T4"
"9911x.T4"

Cause extensions 1000-8999 to be dialed immediately

Cause 8 digit numbers started with 9 to be dialed immediately

Cause 911 to be dialed immediately after it is entered.

Cause 99 to be dialed after 4 seconds.

Cause any number started with 9911 to be dialed 4 seconds after dialing ceases.

**Notice:** End with “#”, Fixed Length, Time out and Digital Map Table can be used simultaneously, System will stop dialing and send number according to your set rules.

### 7.3.4.4 Phone Book

You can input the name, phone number and select ring type for each name here.

## Phone Book

Field name	explanation
	<a href="#">Hangup</a>
Index	Name
Office Num	Mobile Num
Other Num	Ring Type

Shows the detail of current phonebook.

**Name** Shows the name corresponding to the phone number

**Number** Shows the phone number

**Ring Type** Shows the ring type of the incoming call.

Click “Modify” to change the selected information and click the “Delete” to delete the selected record.

**Notice:** the maximum capability of the phonebook is 500 items

DSP	CALL SERVICE	DIGITAL MAP	PHONE BOOK	REMOTE PBOOK	WEB DIAL
-----	--------------	-------------	------------	--------------	----------

**Remote PhoneBook Setting**

Index	Phone book name	Phone book address
1	<input type="text"/>	<input type="text"/>
2	<input type="text"/>	<input type="text"/>
3	<input type="text"/>	<input type="text"/>
4	<input type="text"/>	<input type="text"/>

You need to match a XML Phonebook address and you can directly access the corresponding remote phonebook.

DSP	CALL SERVICE	DIGITAL MAP	PHONE BOOK	REMOTE PBOOK	WEB DIAL
-----	--------------	-------------	------------	--------------	----------

**Web Dial Set**

Dial Num

Select Line

You can make a call through the WEB DIAL, enter the Dial Num then press Dial, if you want to finish the talk, press Hang-up.

## 7.3.4.5 Function Key

FUNCTION KEY
External Console
SOFTKEY

---

**Interface Configuration**

Contrast  (1-9)      Luminance  (0-1)

---

**Line Key Setting**

Line Key	Type	Value	Line	SubType	Pickup Number
Line Key 1	Line	<input type="text"/>	SIP1	None	<input type="text"/>
Line Key 2	Line	<input type="text"/>	SIP2	None	<input type="text"/>
Line Key 3	Line	<input type="text"/>	SIP3	None	<input type="text"/>
Line Key 4	Line	<input type="text"/>	SIP4	None	<input type="text"/>

---

**Function Key Setting**

Memory Key	Type	Value	Line	SubType	Pickup Number
DSS Key 1	Key Event	<input type="text"/>	Auto	Release	<input type="text"/>
DSS Key 2	Key Event	<input type="text"/>	Auto	MWI	<input type="text"/>
DSS Key 3	Key Event	<input type="text"/>	Auto	Head Set	<input type="text"/>
DSS Key 4	None	<input type="text"/>	Auto	None	<input type="text"/>
DSS Key 5	None	<input type="text"/>	Auto	None	<input type="text"/>
DSS Key 6	None	<input type="text"/>	Auto	None	<input type="text"/>
DSS Key 7	None	<input type="text"/>	Auto	None	<input type="text"/>
DSS Key 8	None	<input type="text"/>	Auto	None	<input type="text"/>

---

**Programmable Key**

Key	Desktop	Dailer	Calling	Desktop Long Press
Up	History	pLine	pCall	Status
Down	Status	nLine	nCall	Not set
Left	None	Not set	Not set	Not set
Right	None	Not set	Not set	Sdial
OK	Menu	Not set	Not set	Not set

## Function Key

Field name	explanation
Contrast	Set contrast of screen
Luminance	Set luminance of screen

Line Key	Type	Value	Line	SubType	Pickup Number
Line Key 1	Line		SIP1	None	
Line Key 2	Line		SIP2	None	
Line Key 3	Line		SIP3	None	
Line Key 4	Line		SIP4	None	

**Line:** select Auto, SIP1, SIP2, SIP3, SIP4, or IAX2 in function key type. After you set it, you pick up handset or hands-free, press this function key, and then you can use the corresponding IP line.

Memory Key	Type	Value	Line	SubType	Pickup Number
DSS Key 1	Memory Key		SIP1	None	
DSS Key 2	Key Event		Auto	MWI	
DSS Key 3	Key Event		Auto	Head Set	
DSS Key 4	None		Auto	None	
DSS Key 5	None		Auto	None	
DSS Key 6	None		Auto	None	
DSS Key 7	None		Auto	None	
DSS Key 8	None		Auto	None	

Memory key Type	Set the memory key's serial number
Type	Memory Key: settings can be stored in key storage for each number, the standby or off-hook, select the function keys on the keyboard can call this number. Line, set the dial mode (Auto, SIP1, SIP2, SIP3, SIP4, IAX2).Key Key Event functions, monitor state DTMF: In the call, send DTMF
Value	Set the type parameter values
Line	Choose which lines to use this feature
Subtype	Select the function parameters Key Event

**NOTICE:**

- memory keys can be configured through the following:  
**Speed Dial function**, through the configuration of the key corresponding to the number of ways as shown below

F 1	Memory Key	4116	SIP1	Speed Dial
-----	------------	------	------	------------

User can press the F1 key to allocate this number by line1 line.

**Push To Talk function**, you can press this key in standby to automatically answer the call and make each other;

F 2    Memory Key    4116    SIP1    Push To Talk

User can be configured in accordance with push to talk function the way: 4116 was the other number; Then press the standby button and make it automatically answer the call 4116;

- key can be configured through the following events:

For example:

F 1    Key Event       SIP1    DND

### External Console

External Console has the same usage with the Function key. “In” port connects the phone, “Out” port connects the next one, if there is only, you don’t need for power supply, if there are more than one, you need supply 5V power for the first one, and use RJ-45 direct connector.

FUNCTION KEY    External Console    SOFTKEY

External Console Select

External Console 1    Load    NOT Connected

ExConsole Key	Type	Value	Line	SubType	Pickup Number
F 1	Memory Key	1234	SIP1	Intercom	
F 2	Key Event		SIP1	MWI	
F 3	Line	SIP1	SIP1	None	
F 4	Dtmf	123456	SIP1	None	
F 5	None	SIP1	SIP1	None	
F 6	None	SIP1	SIP1	None	
F 7	None	SIP1	SIP1	None	
F 8	None	SIP1	SIP1	None	
F 9	None	SIP1	SIP1	None	
F 10	None	SIP1	SIP1	None	
F 11	None	SIP1	SIP1	None	
F 12	None	SIP1	SIP1	None	
F 13	None	SIP1	SIP1	None	
F 14	None	SIP1	SIP1	None	
F 15	None	SIP1	SIP1	None	

### SOFTKEY

You can configure different functions in different screens for every soft keys.

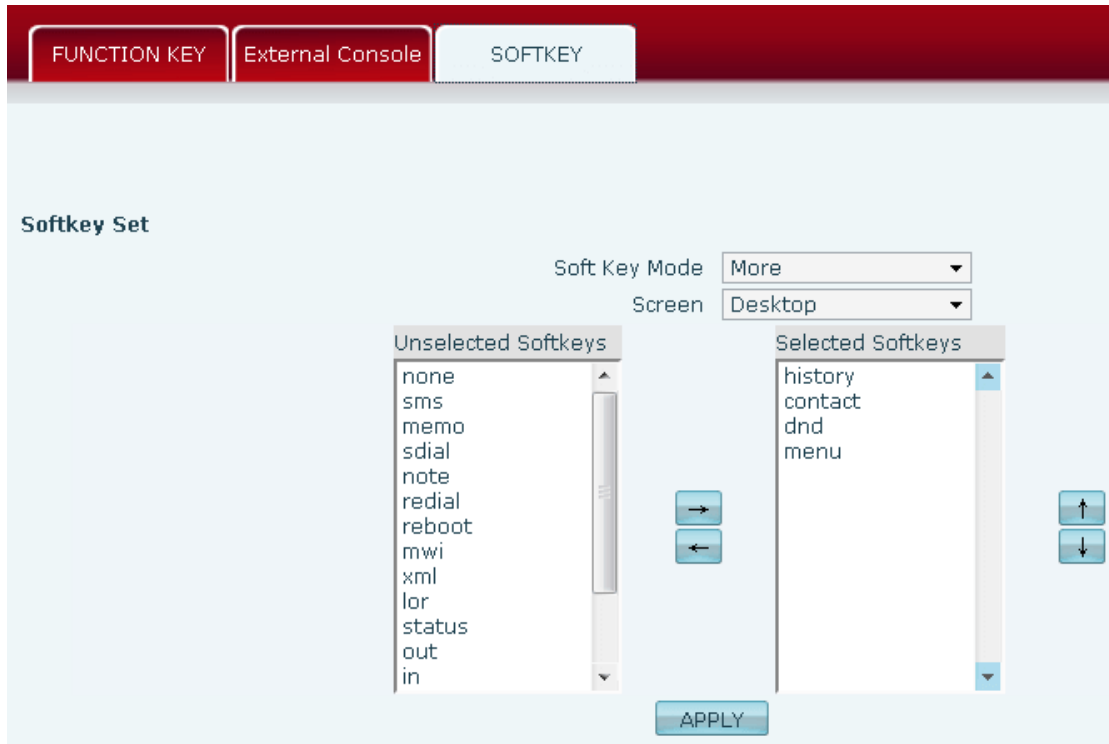

## 7.3.5 Maintenance

### 7.3.5.1 Auto Provision

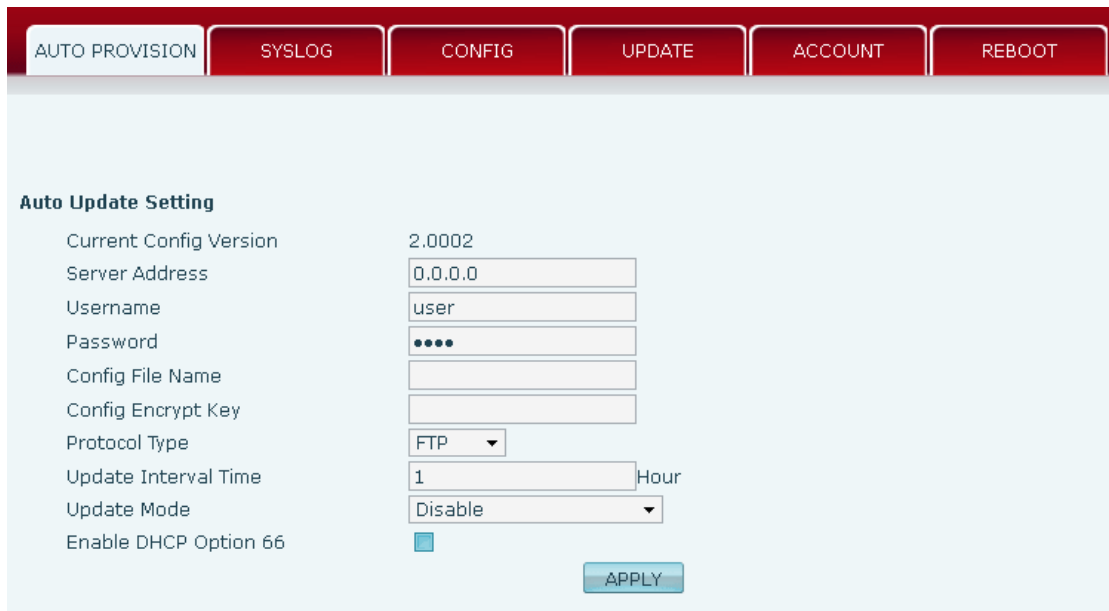

### Auto Provision

Field name	explanation
Current Config	Show the current config file's version.



Version	
Server Address	Set FTP/TFTP/HTTP server IP address for auto update. The address can be IP address or Domain name with subdirectory.
Username	Set FTP server Username. System will use anonymous if username keep blank.
Password	Set FTP server Password.
Config File Name	Set configuration file's name which need to update. System will use MAC as config file name if config file name keep blank. For example, 000102030405.。
Config Encrypt Key	Input the Encrypt Key, if the configuration file is encrypted.
Protocol Type	Select the Protocol type FTP、 TFTP or HTTP.
Update Interval Time	Set update interval time, unit is hour.
Update Mode	Different update modes: 1. Disable: means no update 2. Update after reboot: means update after reboot. 3. Update at time interval: means periodic update.
Enable DHCP Option 66	This option is enabled, TFTP server address defaults to the value of option 66.

### 7.3.5.2 Syslog Config

Syslog is a protocol which is used to record the log messages with client/server mechanism. Syslog server receives the messages from clients, and classifies them based on priority and type. Then these messages will be written into log by some rules which administrator can configure. This is a better way for log management.

8 levels in debug information:

Level 0---emergency: This is highest default debug info level. Your system cannot work.

Level 1---alert: Your system has deadly problem.

Level 2---critical: Your system has serious problem.

Level 3---error: The error will affect your system working.

Level 4---warning: There are some potential dangers. But your system can work.

Level 5---notice: Your system works well in special condition, but you need to check its working environment and parameter.

Level 6---info: the daily debugging info.

Level 7---debug: the lowest debug info Professional debugging info from R&D

person.

At present, the lowest level of debug information send to Syslog is info; debug level only can be displayed on telnet.

**Syslog Set**

Server IP: 0.0.0.0  
Server Port: 514  
MGR Log Level: None  
SIP Log Level: None  
IAX2 Log Level: None  
Enable Syslog:

APPLY

## Syslog Configuration

Field name	explanation
Server IP	Set Syslog server IP address.
Server Port	Set Syslog server port.
MGR Log Level	Set the level of MGR log.
SIP Log Level	Set the level of SIP log.
IAX2 Log Level	Set the level of IAX2 log.
Enable Syslog	Select it or not to enable or disable syslog.

### 7.3.5.3 Config Setting

**Save Configuration**

Press the "Save" button to save the configuration files !

Save

**Backup Config**

Save all Network and VoIP settings.  
Right Click here to Save as Config File (.txt)

**Clear Configuration**

Press the "Clear" button to Clear the configuration files !

Clear

## Config Setting

Field name	explanation
Save Config	You can save all changes of configurations. Click the Save button, all changes of configuration will be saved, and be effective immediately. .
Backup Config	Right clicks on “Right click here...” and select “Save Target As...” then you will save the config file in .txt format
Clear Config	User can restore factory default configuration and reboot the phone. If you login as Admin, the phone will reset all configurations and restore factory default; if you login as Guest, the phone will reset all configurations except for VoIP accounts (SIP1-2 and IAX2) and version number.

### 7.3.5.4 Update

You can update your configuration with your config file in this web page.

The screenshot shows a web interface with a navigation bar at the top containing buttons for AUTO PROVISION, SYSLOG, CONFIG, UPDATE, ACCOUNT, and REBOOT. Below the navigation bar, there are two main sections:

- Web Update:** This section features a text input field labeled "Select file" followed by a "浏览..." (Browse) button. To the right of the input field is a file type filter "(\*.z;\*.txt;\*.au;\*.vcf;\*.wav)" and an "Update" button.
- FTP Update:** This section contains several input fields and dropdown menus:
  - Server: A text input field.
  - Username: A text input field.
  - Password: A text input field.
  - File Name: A text input field.
  - Type: A dropdown menu currently set to "Application update".
  - Protocol: A dropdown menu currently set to "FTP".
 An "APPLY" button is located at the bottom right of this section.

## Update

Field name	explanation
Web Update	Click the browse button, find out the config file saved before or provided by manufacturer, download it to the phone directly, press “Update” to save. You can also update downloaded update file, logo picture, ring, mmiset file by web.
Server	Set the FTP/TFTP server address for download/upload. The address can be IP address or

	Domain name with subdirectory.
Username	Set the FTP server Username for download/upload.
Password	Set the FTP server password for download/upload.
File name	Set the name of update file or config file. The default name is the MAC of the phone, such as 000102030405.

**Notice:** You can modify the exported config file. And you can also download config file which includes several modules that need to be imported. For example, you can download a config file just keep with SIP module. After reboot, other modules of system still use previous setting and are not lost.

	Action type that system want to execute:
Type	<ol style="list-style-type: none"> <li>1. Application update: download system update file</li> <li>2. Config file export: Upload the config file to FTP/TFTP server, name and save it.</li> <li>3. Config file import: Download the config file to phone from FTP/TFTP server. The configuration will be effective after the phone is reset.</li> <li>4. Phone book export (.vcf): Upload the phonebook file to FTP/TFTP server, name and save it.</li> <li>5. PhoneBook import (.vcf): Download the phonebook file to phone from FTP/TFTP server.</li> </ol>
Protocol	Select FTP/TFTP server

### 7.3.5.5 Account Config

You can add or delete user account, and change the authority of each user account in this web page

AUTO PROVISION
SYSLOG
CONFIG
UPDATE
ACCOUNT
REBOOT

---

**Set Menu Password**

Menu Password  Set

---

**Set Keyboard Password**

Keyboard Password

Set Fast KeyLock Code

Enable Keyboard Lock

Set

---

**User Set**

User Name	User Level
admin	Root
guest	General

---

**Add User**

User Name

User Level Root ▼

Password

Confirm

Submit

---

**Account Option**

admin ▼ Delete Modify

## Account Configuration

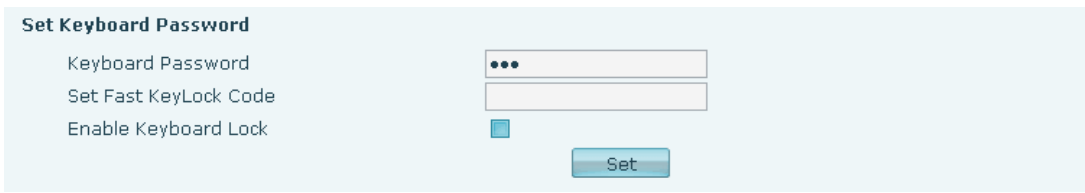
Field name	explanation
Menu Password	Set the password for entering the setting menu of the phone by the phone's key board. The password is digit.
Set fast keylock	
	
Keylock setting	Set up the key lock password. It must be digit and no longer than 6.
Enable keyboard lock	Enable or disable keylock function.
Access accounts list	

User Set	
User Name	User Level
admin	Root
guest	General

This table shows the current user existed.

User Name	Set account user name.
User Level	Set user level, Root user has the right to modify configuration, General can only read.
Password	Set the password.
Confirm	Confirm the password.

Select the account and click the **Modify** to modify the selected account, and click the **Delete** to delete the selected account.

General user only can add the user whose level is General.

### 7.3.5.6 Reboot

The screenshot shows a web interface for managing a phone. A dark red navigation bar at the top contains several menu items: 'AUTO PROVISION', 'SYSLOG', 'CONFIG', 'UPDATE', 'ACCOUNT', and 'REBOOT'. Below this bar, the main content area has a light blue background. It features the heading 'Reboot Phone' and a central instruction: 'Press the "Reboot" button to reboot Phone !'. Directly below the instruction is a blue button labeled 'Reboot'.

If you modified some configurations which need the phone's reboot to be effective, you need click the Reboot, then the phone will reboot immediately.

**Notice:** Before reboot, you need confirm that you have saved all configurations.

## 7.3.6 Security

### 7.3.6.1 MMI Filter

MMI FILTER FIREWALL NAT VPN

**MMI Filter Table**

Start IP	End IP	Option
----------	--------	--------

**MMI Filter Table Set**

Start IP  End IP

**MMI Filter Table Set**

MMI Filter

### MMI Filter

User could make some device own IP, which is pre-specified, access to the MMI of the phone to config and manage the phone.

Field name	explanation						
<b>MMI Filter Table</b>							
<table border="1"><thead><tr><th>Start IP</th><th>End IP</th><th>Option</th></tr></thead><tbody><tr><td><input type="text" value="192.168.1.15"/></td><td><input type="text" value="192.168.1.20"/></td><td><input type="button" value="Modify"/> <input type="button" value="Delete"/></td></tr></tbody></table>	Start IP	End IP	Option	<input type="text" value="192.168.1.15"/>	<input type="text" value="192.168.1.20"/>	<input type="button" value="Modify"/> <input type="button" value="Delete"/>	
Start IP	End IP	Option					
<input type="text" value="192.168.1.15"/>	<input type="text" value="192.168.1.20"/>	<input type="button" value="Modify"/> <input type="button" value="Delete"/>					

MMI Filter IP Table list:

**MMI Filter Table Set**

Start IP  End IP

Add or delete the IP address segments that access to the phone.

Set initial IP address in the Start IP column, Set end IP address in the End IP column, and click Add to add this IP segment. You can also click Delete to delete the selected IP segment.

MMI Filter Select it or not to enable or disable MMI Filter. Click **Apply** to make it effective.

**Notice:** Do not set your visiting IP outside the MMI filter range, otherwise, you cannot logon through the web.

## 7.3.6.2 Firewall

**Firewall Type**

In\_access Enable  Out\_access Enable

---

**Firewall Input Rule Table**

Index	Deny/Permit	Protocol	Src Addr	Src Mask	Des Addr	Des Mask	Range	Port
-------	-------------	----------	----------	----------	----------	----------	-------	------

---

**Firewall Output Rule Table**

Index	Deny/Permit	Protocol	Src Addr	Src Mask	Des Addr	Des Mask	Range	Port
-------	-------------	----------	----------	----------	----------	----------	-------	------

---

**Firewall Set**

Input/Output:  Src Addr:

Deny/Permit:  Des Addr:

Protocol Type:  Src Mask:

Port Range:   Des Mask:

---

**Rule Delete**

Input/Output:  Index To Be Deleted:

### Firewall Configuration

In this web interface, you can set up firewall to prevent unauthorized Internet users from accessing private networks connected to the Internet (input rule), or prevent unauthorized private network devices from accessing the Internet (output rule).

Firewall supports two types of rules: input access rule and output access rule. Each type supports at most 10 items.

Through this web page, you could set up and enable/disable firewall with input/output rules. System could prevent unauthorized access, or access other networks set in rules for security. Firewall, is also called access list, is a simple implementation of a Cisco-like access list (firewall). It supports two access lists: one for filtering input packets, and the other for filtering output packets. Each kind of list could be added 10 items.

We will give you an instance for your reference.

**Firewall Type**

In\_access Enable  Out\_access Enable



**Firewall Set**

Input/Output:       Src Addr:

Deny/Permit:       Des Addr:

Protocol Type:       Src Mask:

Port Range:        Des Mask:

Field name	explanation
In access enable	Select it to Enable in_ access rule
out access enable	Select it to Enable out_ access rule
Input / Output	Specify current adding rule by selecting input rule or output rule.
Deny/Permit	Specify current adding rule by selecting Deny rule or Permit rule.
Protocol Type	Filter protocol type. You can select TCP, UDP, ICMP, or IP.
Port Range	Set the filter Port range
Src Addr	Set source address. It can be single IP address, network address, complete address 0.0.0.0, or network address similar to *.*.*.0
Des Addr	Set the destination address. It can be IP address, network address, complete address 0.0.0.0, or network address similar to *.*.*.*
Src Mask	Set the source address' mask. For example, 255.255.255.255 means just point to one host; 255.255.255.0 means point to a network which network ID is C type.
Des Mask	Set the destination address' mask. For example, 255.255.255.255 means just point to one host; 255.255.255.0 means point to a network which network ID is C type.

Click the **Add** button if you want to add a new output rule.

**Firewall Output Rule Table**

Index	Deny/Permit	Protocol	Src Addr	Src Mask	Des Addr	Des Mask	Range	Port
1	Deny	ICMP	192.168.1.14	255.255.255.0	192.168.1.118	255.255.255.0	More than	0

Then enable out access, and click the Apply button.

So when devices execute to ping 192.168.1.118, system will deny the request to send icmp request to 192.168.1.118 for the out access rule. But if devices ping other devices which network ID is 192.168.1.0, it will be normal.

**Rule Delete**

Input/Output:       Index To Be Deleted:

Click the **Delete** button to delete the selected rule.

### 7.3.6.3 NAT Config

NAT is abbreviated from Net Address Translation; it's a protocol responsible for IP address translation. In other word, it is responsible for transforming IP and port of private network to public, also is the IP address mapping which we usually say.

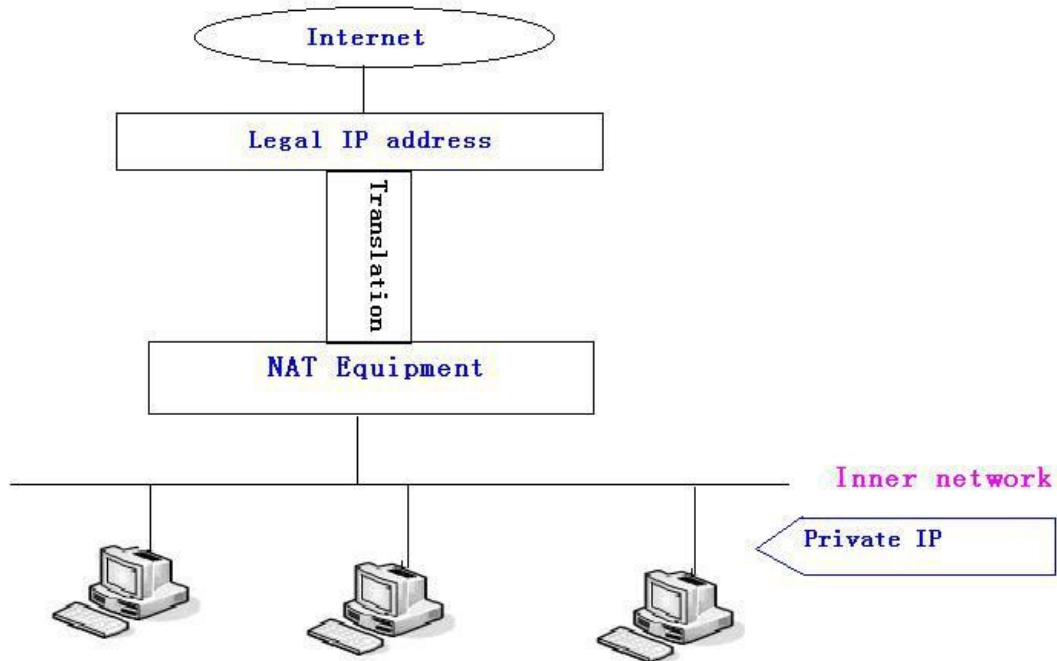

DMZ config:

In order to make some intranet equipments support better service for extranet, and make internal network security more effectively, these equipments open to extranet need be separated from the other equipments not open to extranet by the corresponding isolation method according to different demands. We can provide the different security level protection in terms of the different resources by building a DMZ region which can provide the network level protection for the equipments environment, reduce the risk which is caused by providing service to distrust customer, and is the best position to put public information. The following chart describes the network access control of DMZ.

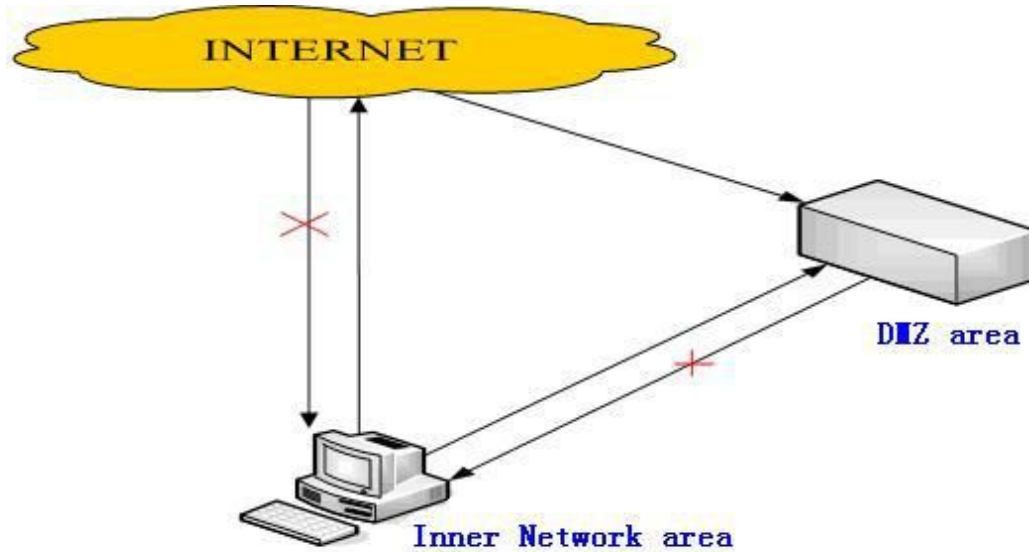

MMI FILTER	FIREWALL	NAT	VPN
<b>Protocol Set</b>			
<input checked="" type="checkbox"/> IPsec ALG	<input checked="" type="checkbox"/> FTP ALG	<input checked="" type="checkbox"/> PPTP ALG	
<input type="button" value="APPLY"/>			
<b>NAT Table</b>			
Inside IP	Inside TCP Port	Outside TCP Port	
Inside IP	Inside UDP Port	Outside UDP Port	
<b>NAT Table Option</b>			
Transfer Type	TCP	Outside Port	<input type="text"/>
Inside IP	<input type="text"/>	Inside Port	<input type="text"/>
<input type="button" value="Add"/>		<input type="button" value="Delete"/>	
<input type="button" value="DMZ Config"/>			

## NAT Configuration

Field name	explanation
IPsec ALG	It is an encryption technology. Select it to enable IPsec ALG, the default is enable
FTP ALG	FTP is a service of connection layer which can transform intranet IP into extranet IP when intranet IP is sending out packet. Select it to enable FTP ALG, the default is enable
PPTP ALG	Select it enable PPTP ALG, the default is enable
Inside IP	Inside TCP Port
Shows the NAT TCP mapping table	
Inside IP	Inside UDP Port
Outside UDP Port	

Shows the NAT UDP mapping table

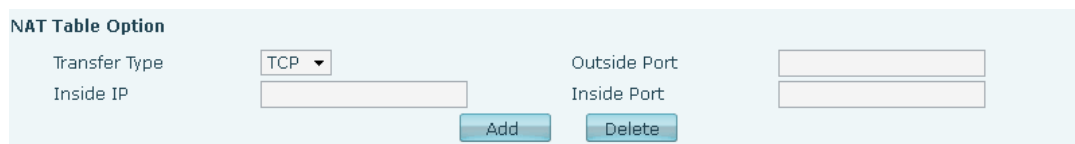

NAT Table Option

Transfer Type: TCP

Inside IP:

Outside Port:

Inside Port:

Add Delete

**Transfer Type** Select the NAT mapping protocol style, TCP or UDP

**Inside IP** Set the IP address of device which is connected to LAN interface to do NAT mapping.

**Inside Port** Set the LAN port of the NAT mapping

**Outside Port** Set the WAN port of the NAT mapping

**Notice:** After finish setting, click the Add button to add new mapping table; click the Delete button to delete the selected mapping table.

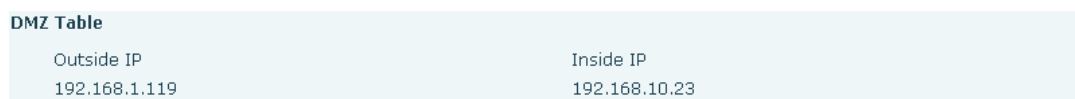

DMZ Table

Outside IP	Inside IP
192.168.1.119	192.168.10.23

Shows the outside WAN port IP address and the inside LAN port IP address.

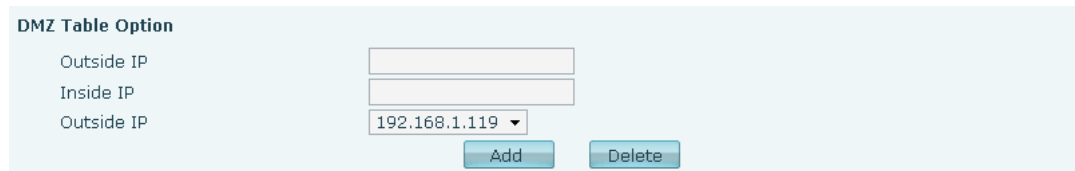

DMZ Table Option

Outside IP:

Inside IP:

Outside IP: 192.168.1.119

Add Delete

**Outside IP** Set the outside Wan port IP address of DMZ.

**Inside IP** Set the inside LAN port IP address of DMZ

Click the **Add** button to add new table; click the **Delete** button to delete the selected mapping table.

**Notice:** 10M/100M adaptive means the network card, and other equipment physical consultations speed, testing speed under bridge mode near to 100M, in order to ensure the quality of voice and communications real-time performance, we made some sacrifices of NAT under the transmission performance. Transmit with full capability only when system is idle, so cannot guarantee that the transmission speed reach to 100M.

#### 7.3.6.4 VPN Config

This web page provides us a safe connect mode by which we can make remote access to enterprise inner network from public network. That is to say, you can set it to connect public networks in different areas into inner network via a special tunnel.

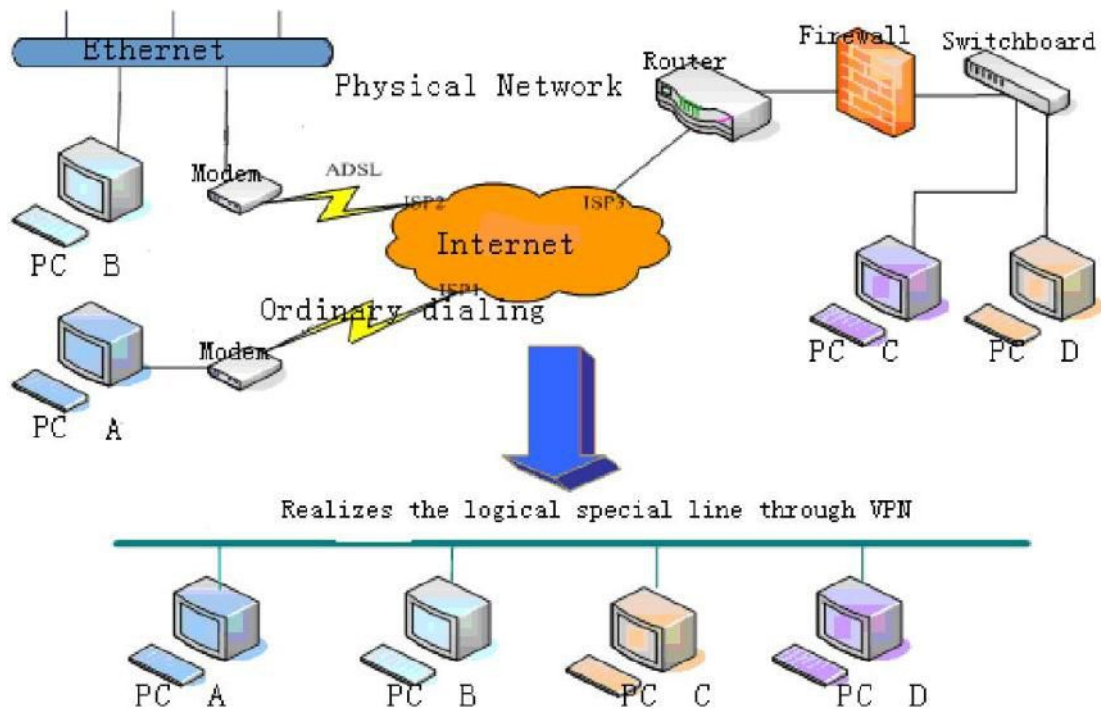

MMI FILTER	FIREWALL	NAT	VPN
<b>VPN IP</b>			
0.0.0.0			
<b>VPN Mode</b>			
<input checked="" type="radio"/> L2TP		<input type="checkbox"/> Enable VPN	
<b>L2TP</b>			
VPN Server Addr	<input type="text"/>	VPN User Name	<input type="text"/>
VPN Password	<input type="text"/>		
<input type="button" value="APPLY"/>			

## VPN Configuration

Field name	explanation
VPN IP	Shows the current VPN IP address
<b>VPN Mode</b>	
<input checked="" type="radio"/> L2TP	<input type="checkbox"/> Enable VPN

Select L2TP. You can choose only one for current state. After you select it, you'd better save configuration and reboot your phone.

Enable VPN                      Select it or not to enable or disable VPN;

**L2TP**

VPN Server Addr	<input type="text"/>	VPN User Name	<input type="text"/>
VPN Password	<input type="text"/>		

---

VPN Server Addr	Set VPN L2TP Server IP address
VPN User Name	Set User Name access to VPN L2TP Server
VPN Password	Set Password access to VPN L2TP Server

---

### 7.3.7 Logout

**Logout**

Press the "Logout" button to Logout Phone !

Click **Logout**, and you will exit web page. If you want to enter it next time, you need input user name and password again.

# 8 Appendix

## 8.1 Specification

### 8.1.1 Hardware

Item		C62(P)
Adapter (Input / Output)		Input: 100-240V Output: 5V 1A
port	WAN	10/100Base- T RJ-45 1 PORT
	LAN	10/100Base- T RJ-45 1 PORT
Power Consumption		Idle: 2.5W/Active: 2.8W
LCD Size		128x64 53.5 x 70mm
Operation Temperature		0~40°C
Relative Humidity		10~65%
CPU		Broadcom
SDRAM		16MB
Flash		4MB
Dimension(L x W x H)		
Weight		

### Voice features

- SIP supports 4 SIP servers
- Support SIP 2.0 (RFC3261) and correlative RFCs
- Codec: G.711A/u, G.723.1 high/low, G.729a/b, G.722, G.726, AMR
- Echo cancellation: G.168 Compliance in LEC, additional acoustic echo cancellation(AEC) can reach 96ms max filter length in hands-free mode
- Support Voice Gain Setting, VAD, CNG
- Support full duplex hands-free
- Support multi line/HD Voice
- SIP support SIP domain, SIP authentication(none basic, MD5), DNS name of server, Peer to Peer/ IP call

- Automatically select calling line, if one line can't be connected, the phone can automatically switch to other line to call.
- 9 kinds of ring types and 5 user-defined music rings
- DTMF Relay: support SIP info, DTMF Relay, RFC2833
- SIP application: SIP Call forward/transfer (blind/attended) /hold/waiting/3 way talking/SMS/pickup /join call /redial /unredial/multi line/intercom/BLF/presence/push to talk/auto redial/call return
- Call control features: Flexible dial map, hotline, empty calling No. reject service, black list for reject authenticated call, white list, limit call, no disturb, caller ID, CLIR(reject the anonymous call), CLIP(make a call with anonymous), Dial without register.
- Support phonebook 500 records, Incoming calls / outgoing calls / missed calls. Each supports 100 records.
- Support IAX2
- 4 line keys defined as multi line with screen display or used as SIP line keys
- 8 DSS keys
- Soft keys programmable, function keys programmable
- Code synchronization via IP PBX/IMS
- Support EXT DSS consoles with 5 max
- Support click to dial via web phone book/Group listening
- Voice codec setting for each SIP line
- Support keypad lock, and emergency call during the keypad lock
- Customized lcd logo
- Ring play via headset or speaker setting
- Signal tone parameters customized
- Phonebook supports vcard standard
- 12/24 hours time display
- Support daylight saving time
- Support path, group
- Support SIP Privacy
- Support SMS
- Support WMI
- Support Speed dial
- Support XML

### **8.1.2 Network features**

- WAN/LAN: support bridge and router model
- Support PPPoE for xDSL
- Support basic NAT and NAPT
- Support VLAN
- NAT Penetrate, Stun Penetrate















- Support DMZ
- Support VPN (L2TP) function
- Wan Port supports main DNS and secondary DNS server, can select dynamically to get DNS in DHCP mode or statically set DNS address.
- Support DHCP client on WAN
- Support DHCP server on LAN
- QoS with DiffServ
- Network tools in telnet server: including ping, trace route, telnet client

### 8.1.3 Maintenance and management

- Upgrade firmware through POST mode
- Web ,telnet and keypad management
- Management with different account right
- LCD and WEB configuration can be modified into requested language, and support multi-language dynamically shifted
- Upgrade firmware through HTTP, FTP or TFTP Telnet remote management/ upload/download setting file
- Support Syslog
- Support Auto Provisioning (upgrade firmware or configuration file)

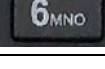
## 8.2 Digit-character map table

Keypad	Character	Keypad	Character
	1 @		7 P Q R S p q r s
	2 A B C a b c		8 T U V t u v
	3 D E F d e f		9 W X Y Z w x y z
	4 G H I g h i		* / .
	5 J K L j k l		0
	6 M N O m n o		# / =