

EDS-405A/408A Series Hardware Installation Guide

Moxa EtherDevice™ Switch

Ninth Edition, December 2014



© 2014 Moxa Inc. All rights reserved.
Reproduction without permission is prohibited.

P/N: 1802004000018

Overview

The Moxa EtherDevice™ EDS-405A/408A series, which includes both 5 and 8-port smart Ethernet switches, is a cost-effective solution for your Ethernet connections. In addition, the built-in smart alarm function helps system maintainers monitor the health of your Ethernet network.

Package Checklist

The Moxa EDS-405A/408A switches are shipped with the following items. If any of these items is missing or damaged, please contact your customer service representative for assistance.

- EDS-405A or EDS-408A Ethernet switch
- RJ45-to-DB9 console port cable
- Protective caps for unused ports
- Panel mounting kit (optional—must order separately)
- Hardware installation guide
- CD-ROM with user's manual and Windows utility
- Warranty card

EDS-405A/408A Panel Layout (standard)

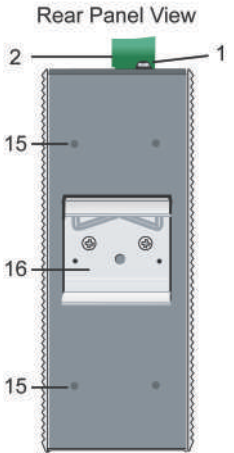
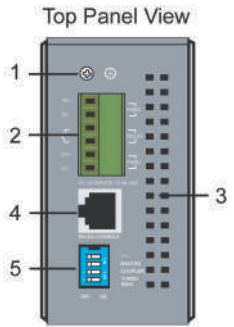
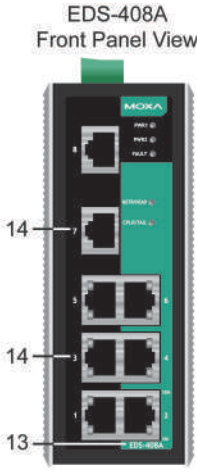
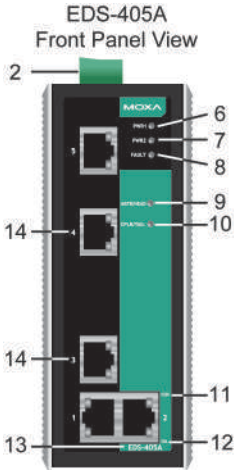

1. Grounding screw
2. Terminal block for power input PWR1/PWR2 and relay output
3. Heat dissipation vents
4. Console port
5. DIP switches
6. Power input PWR1 LED
7. Power input PWR2 LED
8. Fault LED
9. MSTR/HEAD: LED indicator
10. CPLR/TAIL: LED indicator
11. TP port's 100 Mbps LED
12. TP port's 10 Mbps LED
13. Model Name
14. 10/100BaseT(X) ports
15. Screw hole for wall mounting kit
16. DIN-Rail kit

EDS-405A/408A-MM (SC-type) Panel Layout

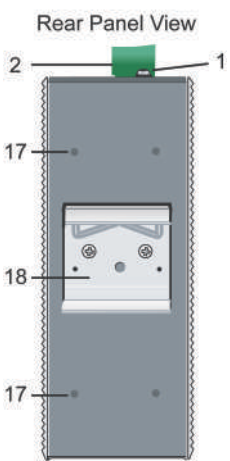
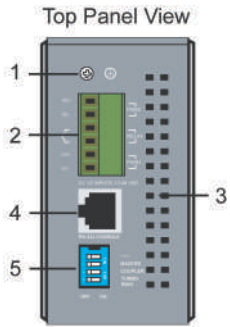
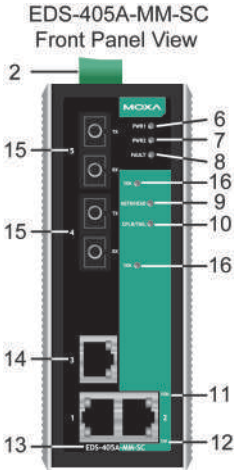

NOTE:

The appearance of the EDS-405A-SS-SC is identical to that of the EDS-405A-MM-SC. The appearance of the EDS-408A-SS-SC is identical to that of the EDS-408A-MM-SC.

1. Grounding screw
2. Terminal block for power input PWR1/PWR2 and relay output
3. Heat dissipation vents
4. Console port
5. DIP switches
6. Power input PWR1 LED
7. Power input PWR2 LED
8. Fault LED
9. MSTR/HEAD: LED indicator
10. CPLR/TAIL: LED indicator
11. TP port's 100 Mbps LED
12. TP port's 10 Mbps LED
13. Model Name
14. 10/100BaseT(X) ports
15. 100BaseFX ports
16. FX port's 100 Mbps LEDs
17. Screw hole for wall mounting kit
18. DIN-Rail kit

EDS-405A/408A-MM (ST-type) Panel Layout

EDS-405A-MM-ST
Front Panel View

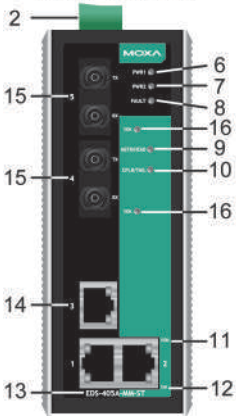

EDS-408A-MM-ST
Front Panel View

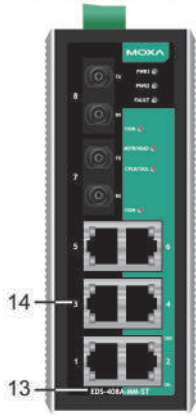

Top Panel View

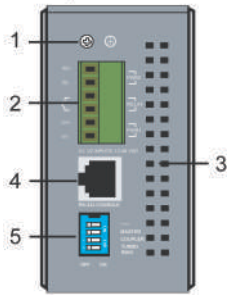

Rear Panel View

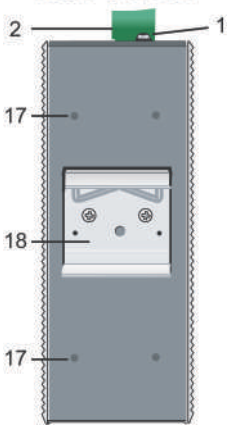

1. Grounding screw
2. Terminal block for power input PWR1/PWR2 and relay output
3. Heat dissipation vents
4. Console port
5. DIP switches
6. Power input PWR1 LED
7. Power input PWR2 LED
8. Fault LED
9. MSTR/HEAD: LED indicator
10. CPLR/TAIL: LED indicator
11. TP port's 100 Mbps LED
12. TP port's 10 Mbps LED
13. Model Name
14. 10/100BaseT(X) ports
15. 100BaseFX ports
16. FX port's 100 Mbps LEDs
17. Screw hole for wall mounting kit
18. DIN-Rail kit

EDS-408A-3M Panel Layout (SC/ST-type)

EDS-408A-3M-SC
Front Panel View

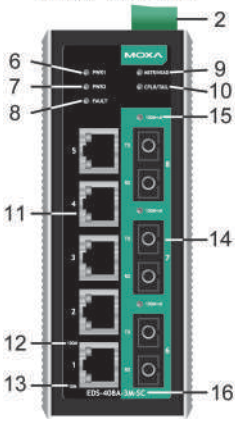

EDS-408A-3M-ST
Front Panel View

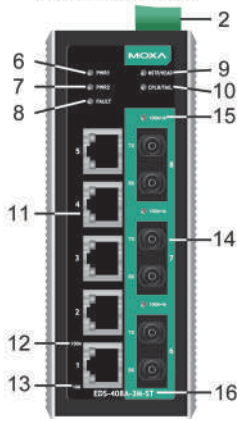

Top Panel View

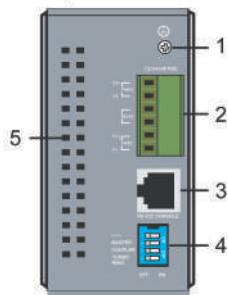

Rear Panel View

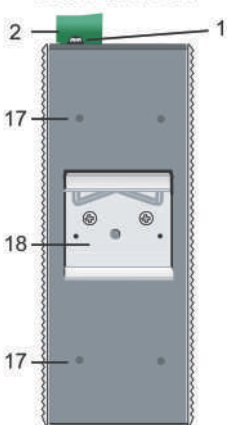

NOTE:

The appearance of the EDS-408A-3S-SC, EDS-408A-1M2S-SC, and EDS-408A-2M1S-SC are identical to that of the EDS-408A-3M-SC.

1. Grounding screw
2. Terminal block for power input PWR1/PWR2 and relay output
3. Console port
4. DIP switches
5. Heat dissipation vents
6. Power input PWR1 LED
7. Power input PWR2 LED
8. Fault LED
9. MSTR/HEAD: LED indicator
10. CPLR/TAIL: LED indicator
11. 10/100BaseT(X) ports
12. TP port's 100 Mbps LED
13. TP port's 10 Mbps LED
14. 100BaseFX ports
15. 1 FX port's 100Mbps LEDs
100M-M: multi mode FX port
100M-S: single mode FX port
16. Model Name
17. Screw hole for wall mounting kit
18. DIN-Rail kit

Mounting Dimensions (unit = mm)

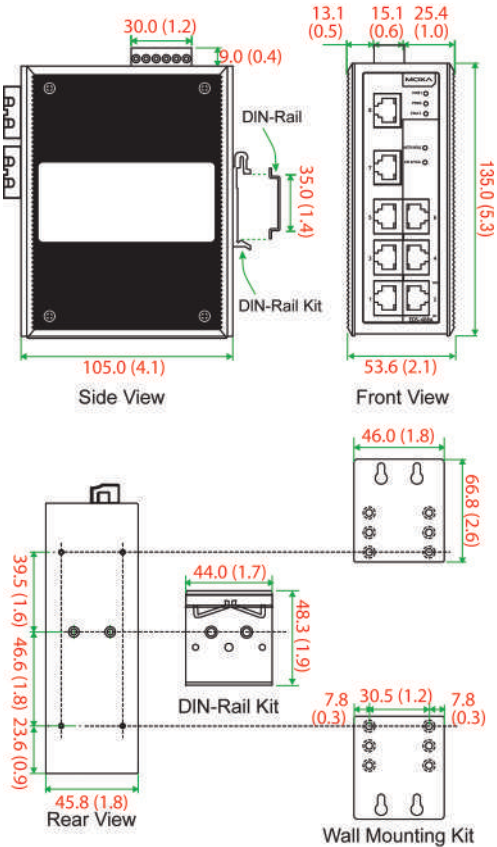

Unit = mm (inch)

DIN-Rail Mounting

The aluminum DIN-Rail attachment plate should already be fixed to the back panel of the EDS-405A/408A when you take it out of the box. If you need to reattach the DIN-Rail attachment plate, make sure the stiff metal spring is situated towards the top, as shown in the following figures.

STEP 1:

Insert the top of the DIN-Rail into the slot just below the stiff metal spring.

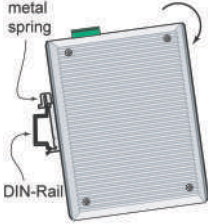

STEP 2:

The DIN-Rail attachment unit will snap into place as shown.

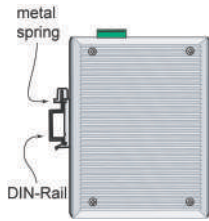

To remove the Moxa EtherDevice switch from the DIN-Rail, simply reverse Steps 1 and 2.

Wall Mounting (optional)

For some applications, you will find it convenient to mount the EDS-405A/408A on the wall, as shown in the following figures.

STEP 1:

Remove the aluminum DIN-Rail attachment plate from the EDS-405A/408A's rear panel, and then attach the wall mount plates with M3 screws, as shown in the diagram at the right.

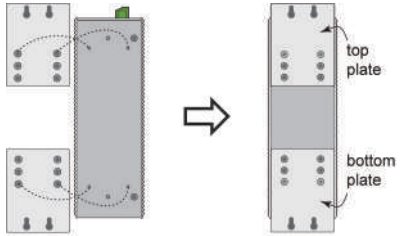

STEP 2:

Mounting the EDS-405A/408A on the wall requires 4 screws. Use the switch, with wall mount plates attached, as a guide to mark the correct locations of the 4 screws. The heads of the screws should be less than 6.0 mm in diameter, and the shafts should be less than 3.5 mm in diameter, as shown in the figure at the right.

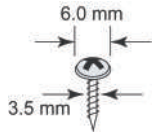

NOTE Before tightening the screws into the wall, make sure the screw head and shank size are suitable by inserting the screw into one of the keyhole-shaped apertures of the wall mounting plates.

Do not screw the screws in completely—leave about 2 mm to allow room for sliding the wall mount panel between the wall and the screws.

STEP 3: Once the screws are fixed in the wall, insert the four screw heads through the large parts of the keyhole-shaped apertures, and then slide the EDS-405A/408A downwards, as indicated. Tighten the four screws for added stability.

ATEX Information

1. Certificate number: DEMKO 08 ATEX 0712961X
2. Ambient range ($-40^{\circ}\text{C} \leq T_{\text{amb}} \leq 75^{\circ}\text{C}$)
3. Certification string:
EDS-405A: Ex nA nC IIC T4 Gc
EDS-408A: EX nA nC op is IIC T4 Gc
4. Standards covered (EN 60079-0:2012, EN 60079-15:2010)
5. The conditions of safe usage:



- These products must be mounted in an IP54 enclosure.
- Install in an area of pollution degree 2 or less.
- Use a conductor wire of size 0.2 mm² or greater.
- PROVISIONS SHOULD BE MADE, EXTERNAL TO THE APPARATUS, TO PREVENT THE RATED VOLTAGE FROM BEING EXCEEDED BY TRANSIENT DISTURBANCES OF MORE THAN 40%.

Wiring Requirements



WARNING

Safety First!

Be sure to disconnect the power cord before installing and/or wiring your Moxa EtherDevice Switch.

Calculate the maximum possible current in each power wire and common wire. Observe all electrical codes dictating the maximum current allowable for each wire size.

If the current goes above the maximum ratings, the wiring could overheat, causing serious damage to your equipment.

Be sure to read and follow these important guidelines:

- Use separate paths to route wiring for power and devices. If power wiring and device wiring paths must cross, make sure the wires are perpendicular at the intersection point.
NOTE: Do not run signal or communications wiring and power wiring through the same wire conduit. To avoid interference, wires with different signal characteristics should be routed separately.
- Use the type of signal transmitted through a wire to determine which wires should be kept separate. The rule of thumb is that wiring that shares similar electrical characteristics can be bundled together.
- Keep input wiring and output wiring separate.
- When necessary, you should label the wiring to all devices in the system.

Grounding the EtherDevice Switch

Grounding and wire routing help limit the effects of noise due to electromagnetic interference (EMI). Run the ground connection from the ground screw to the grounding surface prior to connecting devices.



ATTENTION

This product is intended to be mounted to a well-grounded mounting surface, such as a metal panel.

Wiring the Relay Contact

The Relay Contact consists of the two middle contacts of the terminal block on the EDS-405A/408A's top panel. Refer to the next section for detailed instructions on how to connect the wires to the terminal block connector, and how to attach the terminal block connector to the terminal block receptor.

In this section, we explain the meaning of the two contacts used to connect the Alarm Contact.

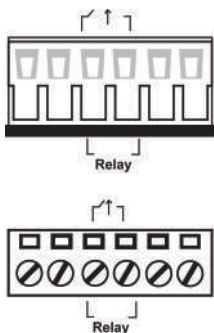

FAULT: The two middle contacts of the 6-contact terminal block connector are used to detect both power faults and port faults. The two wires attached to the fault contacts form an open circuit when:

A relay warning event is triggered.

OR

The EDS-405A/408A is the Master of this Turbo Ring, and the Turbo Ring is broken.

OR

There is a start-up failure.

If none of these three conditions is satisfied, the fault circuit will remain closed.

Wiring the Redundant Power Inputs

The top two contacts and the bottom two contacts of the 6-contact terminal block connector on the EDS-405A/408A's top panel are used for the EDS-405A/408A's two DC inputs. Top and front views of one of the terminal block connectors are shown in the following figures:

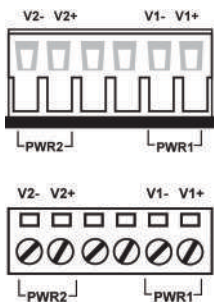

STEP 1: Insert the negative/positive DC wires into the V-/V+ terminals, respectively.

STEP 2: To keep the DC wires from pulling loose, use a small flat-blade screwdriver to tighten the wire-clamp screws on the front of the terminal block connector.

STEP 3: Insert the plastic terminal block connector prongs into the terminal block receptor, which is located on the EDS-405A/408A's top panel.



ATTENTION

Before connecting the EDS-405A/408A to the DC power inputs, make sure the DC power source voltage is stable.

Communication Connections

EDS-408A models have 5, 6, or 8 10/100BaseT(X) Ethernet ports, and 3, 2, or 0 (zero) 100BaseFX (SC/ST-type connector) fiber ports. EDS-405A models have 3 or 5 10/100BaseT(X) Ethernet ports, and 2 or 0 (zero) 100 BaseFX (SC/ST-type connector) fiber ports.

10/100BaseT(X) Ethernet Port Connection

The 10/100BaseT(X) ports located on the EDS's front panel are used to connect to Ethernet-enabled devices.

Next, we show pinouts for both MDI (NIC-type) ports and MDI-X (HUB/Switch-type) ports, and also show cable wiring diagrams for **straight-through and cross-over Ethernet cables**.

10/100Base T(x) RJ45 Pinouts

MDI Port Pinouts

Pin	Signal
1	Tx+
2	Tx-
3	Rx+
6	Rx-

MDI-X Port Pinouts

Pin	Signal
1	Rx+
2	Rx-
3	Tx+
6	Tx-

8-pin RJ45

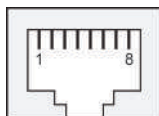

RJ45 (8-pin) to RJ45 (8-pin) Straight-Through Cable Wiring

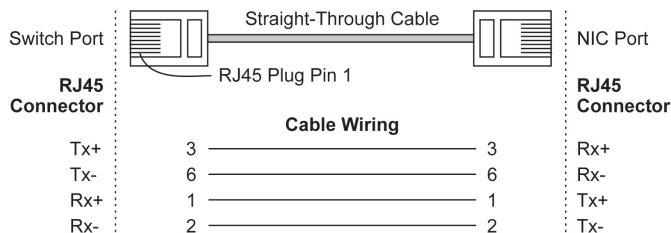

RJ45 (8-pin) to RJ45 (8-pin) Cross-Over Cable Wiring

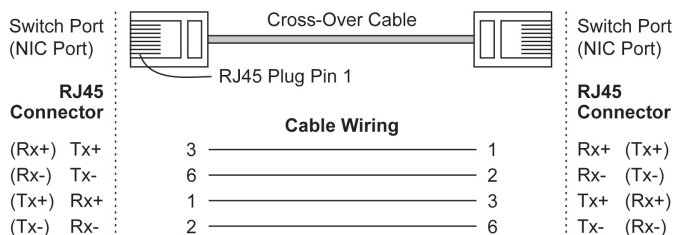

100BaseFX Ethernet Port Connection

The concept behind the SC/ST port and cable is quite straightforward. Suppose you are connecting devices I and II; contrary to electrical signals, optical signals do not require a circuit in order to transmit data. Consequently, one of the optical lines is used to transmit data from device I to device II, and the other optical line is used transmit data from device II to device I, for full-duplex transmission.

Remember to connect the Tx (transmit) port of device I to the Rx (receive) port of device II, and the Rx (receive) port of device I to the Tx (transmit) port of device II. If you make your own cable, we suggest labeling the two sides of the same line with the same letter (A-to-A and B-to-B, as shown below, or A1-to-A2 and B1-to-B2).

SC-Port Pinouts

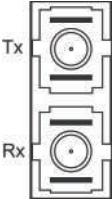

SC-Port to SC-Port Cable Wiring

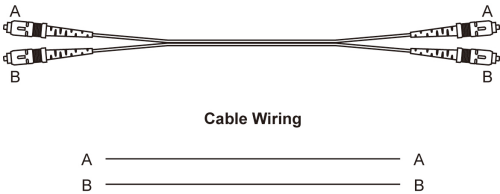

ST-Port Pinouts



ST-Port to ST-Port Cable Wiring

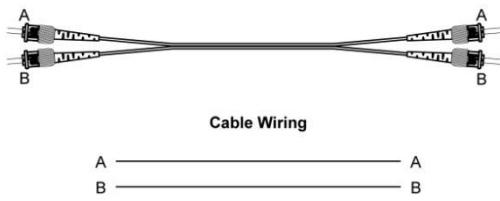



ATTENTION This is a Class 1 Laser/LED product. To avoid causing serious damage to your eyes, do not stare directly into the laser beam.

Redundant Power Inputs

Both power inputs can be connected simultaneously to live DC power sources. If one power source fails, the other live source acts as a backup, and automatically supplies the EDS-405A/408A with power.

Relay Contact

The Moxa EtherDevice switch has one relay contact located on the top panel. For detailed instructions on how to connect the relay contact power wires to the two middle contacts of the 6-contact terminal block connector, see the **Wiring the Relay Contact** section. A typical scenario would be to connect the fault circuit to a warning light located in the control room. The light can be set up to switch on when a fault is detected.

The relay contact has two terminals that form a fault circuit for connecting to an alarm system. The two wires attached to the fault contacts form an open circuit when (1) a relay warning event is triggered, (2) the EDS-405A/408A is the Master of this Turbo Ring, and the Turbo Ring is broken, or (3) there is a start-up failure. If none of these three conditions occur, the fault circuit will be closed.

Turbo Ring DIP Switch Settings

EDS-405A/408A series switches are plug-and-play managed redundant Ethernet switches. The proprietary Turbo Ring protocol was developed by Moxa to provide better network reliability and faster recovery time. Moxa Turbo Ring's recovery time is less than 300 ms (**Turbo Ring**) or 20 ms (**Turbo Ring V2**) —compared to a 3 to 5-minute recovery time for commercial switches—decreasing the possible loss caused by network failures in an industrial setting.

There are 4 Hardware DIP Switches for Turbo Ring on the top panel of the EDS-405A/408A that can be used to set up the Turbo Ring easily within seconds. If you do not want to use a hardware DIP switch to set up Turbo Ring, you can use a web browser, Telnet, or console to disable this function.

NOTE Refer to the **Turbo Ring DIP Switch** section and **Using Communication Redundancy** section in the user's manual for detailed information about the settings and usage of **Turbo Ring** and **Turbo Ring V2**.

EDS-405A/408A Series DIP Switches

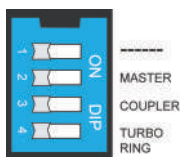

The default setting for each DIP Switch is OFF. The following table explains the effect of setting the DIP Switch to the ON position.

"Turbo Ring" DIP Switch Settings

DIP 1	DIP 2	DIP 3	DIP 4
Reserved for future use.	<u>ON</u> : Enables this EDS as the Ring Master.	<u>ON</u> : Enables the default "Ring Coupling" ports.	<u>ON</u> : Activates DIP switches 1, 2, 3 to configure "Turbo Ring" settings.
	<u>OFF</u> : This EDS will not be the Ring Master.	<u>OFF</u> : Do not use this EDS as the ring coupler.	<u>OFF</u> : DIP switches 1, 2, 3 will be disabled.

"Turbo Ring V2" DIP Switch Settings

DIP 1	DIP 2	DIP 3	DIP 4
<u>ON</u> : Enables the default "Ring Coupling (backup)" port.	<u>ON</u> : Enables this EDS as the Ring Master.	<u>ON</u> : Enables the default "Ring Coupling" port.	<u>ON</u> : Activates DIP switches 1, 2, 3 to configure "Turbo Ring V2" settings.
<u>OFF</u> : Enables the default "Ring Coupling (primary)" port.	<u>OFF</u> : This EDS will not be the Ring Master.	<u>OFF</u> : Do not use this EDS as a ring coupler.	<u>OFF</u> : DIP switches 1, 2, 3 will be disabled.

NOTE If you do not enable any of the EDS-405A/408A switches to be the Ring Master, the Turbo Ring protocol will automatically choose the EDS-405A/408A with the smallest MAC address range to be the Ring Master. If you accidentally enable more than one EDS-405A/408A to be the Ring Master, these EDS-405A/408A switches will auto-negotiate to determine which switch will be the Ring Master.

NOTE To switch on the Master or Coupler functions of the DIP switch, you need to enable the Turbo Ring Pole first.

LED Indicators

There are several LEDs on the EDS's front panel. The function of each LED is described in the following table.

LED	Color	State	Description
PWR1	AMBER	On	Power is being supplied to power input PWR1.
		Off	Power is not being supplied to power input PWR1.
PWR2	AMBER	On	Power is being supplied to power input PWR2.
		Off	Power is not being supplied to power input PWR2.
FAULT	RED	On	When (1) a relay warning event is triggered, (2) the EDS-405A/408A is the Master of this Turbo Ring, and the Turbo Ring is broken, or (3) start-up failure.
		Off	When a relay warning event is not triggered.
MSTR/HEAD	GREEN	On	When the EDS-405A/408A is set as the Master of the Turbo Ring, or as the Head of the Turbo Chain.
		Blinking	The EDS-405A/408A has become the Ring Master of the Turbo Ring, or the Head of the Turbo Chain, after the Turbo Ring or the Turbo Chain is down.
		Off	When the EDS-405A/408A is not the Master of this Turbo Ring or is set as the Member of the Turbo Chain.
CPLR/TAIL	GREEN	On	When the EDS-405A/408A coupling function is enabled to form a back-up path, or when it's set as the Tail of the Turbo Chain.
		Blinking	When the Turbo Chain is down.
		Off	When the EDS-405A/408A disables the coupling function, or is set as the Member of the Turbo Chain.
10M (TP)	GREEN	On	TP port's 10 Mbps link is active.
		Blinking	Data is being transmitted at 10 Mbps.
		Off	TP Port's 10 Mbps link is inactive.

100M (TP)	GREEN	On	TP port's 100 Mbps link is active.
		Blinking	Data is being transmitted at 100 Mbps.
		Off	TP Port's 100 Mbps link is inactive.
100M (FX)	GREEN	On	FX port's 100 Mbps is active.
		Blinking	Data is being transmitted at 100 Mbps.
		Off	FX port's 100 Mbps is inactive.

Auto MDI/MDI-X Connection

The Auto MDI/MDI-X function allows users to connect the EDS-405A/408A's 10/100BaseTX ports to any kind of Ethernet device, without needing to pay attention to the type of Ethernet cable being used for the connection. This means that you can use either a *straight-through* cable or *cross-over* cable to connect the EDS-405A/408A to Ethernet devices.

Specifications

Technology		
Standards	IEEE802.3, 802.3u, 802.3x, 802.1D, 802.1Q, 802.1w, 802.1p	
Protocols	IGMP V1/V2 device, GMRP, GVRP, SNMPv1/v2c/v3, DHCP Server/Client, TFTP, SNMP, SMTP, RARP, RMON, HTTP, Telnet, Syslog, DHCP Option 66/67/82, BootP, LLDP, Modbus TCP, IPv6	
MIB	MIB-II, Ethernet-Like MIB, P-BRIDGE MIB, RMON MIB Group 1, 2, 3, 9, Bridge MIB, RSTP MIB	
Forwarding and Filtering Rate	148810 pps	
Processing Type	Store and Forward	
Flow Control	IEEE802.3x flow control, back pressure flow control	
Interface		
RJ45 Ports	10/100BaseT(X) auto negotiation speed, F/H duplex mode, and auto MDI/MDI-X connection	
Fiber Ports	100BaseFX ports (SC/ST connector)	
Console	RS-232 (RJ45)	
LED Indicators	PWR1, PWR2, FAULT, 10/100M (TP port), 100M (Fiber Port), CPLR/TAIL and MSTR/HEAD	
Relay Contact	One relay output with current carrying capacity of 1A @ 24 VDC	
DIP Switches	Master, Coupler, Turbo Ring, Reserve	
Optical Fiber		
	Multi-mode	Single-mode
Wavelength	1300 nm	1310 nm
Max. Tx	-10 dBm	0 dBm
Min. Tx	-20 dBm	-5 dBm
Rx Sensitivity	-32 dBm	-34 dBm
Link Budget	12 dB	29 dB
Typical Distance	5 km ^a , 4 km ^b	40 km ^c
Saturation	-6 dBm	-3 dBm
a. when using [50/125 μm, 800 MHz*km] cable		
b. when using [62.5/125 μm, 500 MHz*km] cable		
c. when using [9/125 μm, 3.5 PS/(nm*km)] cable		

Power	
Input Voltage	EDS-405A/408A: 12 to 45 VDC, redundant inputs EDS-408A-3S-SC-48: ±24/±48 VDC (-60 to -19 VDC or 19 to 60 VDC), redundant inputs (The mixing of power polarity system is prohibited.)
Input Current (@ 24 V)	EDS-405A: Max. 0.24 A EDS-408A: Max. 0.21 A EDS-405A-MM, EDS-405A-SS: Max. 0.32 A EDS-408A-MM, EDS-408A-SS: Max. 0.26 A EDS-408A-3M/3S/2M1S/1M2S: Max. 0.32 A
Connection	One removable 6-pin terminal block
Overload Current Protection	Present
Reverse Polarity Protection	Present
Physical Characteristics	
Housing	Metal, IP30 protected
Dimensions	53.6 × 135 × 105 mm
Weight	0.65 kg (EDS-405A models) 0.89 kg (EDS-408A models)
Installation	DIN-Rail, Wall Mounting (optional kit)
Environmental Limits	
Operating Temperature	0 to 60°C (32 to 140°F); -40 to 75°C (-40 to 167°F) for -T models
Storage Temperature	-40 to 85°C (-40 to 185°F)
Ambient Relative Humidity	5% to 95% (non-condensing)
Regulatory Approvals	
Safety	EDS-405A/408A: UL 60950-1, UL 508, CSA C22.2 No. 60950-1, EN 60950-1 EDS-408A-3S-SC-48: UL508 (Pending)
Hazardous Location	UL/cUL Class I, Division 2, Groups A, B, C and D ATEX Zone 2 : EDS-405A: Ex nC nL IIC T4 EDS-408A: EX nA nC op is IIC T4 Gc
EMI	FCC Part 15, CISPR (EN 55022) class A
EMS	EN 61000-4-2 (ESD), Level 3 EN 61000-4-3 (RS), Level 3 EN 61000-4-4 (EFT), Level 3 EN 61000-4-5 (Surge), Level 3 EN 61000-4-6 (CS), Level 3
Shock	IEC 60068-2-27
Freefall	IEC 60068-2-32
Vibration	IEC 60068-2-6
WARRANTY	5 years

Technical Support Contact Information

www.moxa.com/support

Moxa Americas:

Toll-free: 1-888-669-2872

Tel: 1-714-528-6777

Fax: 1-714-528-6778

Moxa China (Shanghai office):

Toll-free: 800-820-5036

Tel: +86-21-5258-9955

Fax: +86-21-5258-5505

Moxa Europe:

Tel: +49-89-3 70 03 99-0

Fax: +49-89-3 70 03 99-99

Moxa Asia-Pacific:

Tel: +886-2-8919-1230

Fax: +886-2-8919-1231