

NPort 5000AI-M12 Series User Manual

Second Edition, June 2014

www.moxa.com/product



© 2014 Moxa Inc. All rights reserved.
Reproduction without permission is prohibited.

NPort 5000AI-M12 Series User Manual

The software described in this manual is furnished under a license agreement and may be used only in accordance with the terms of that agreement.

Copyright Notice

Copyright ©2014

Moxa Inc.

All rights reserved.

Reproduction without permission is prohibited.

Trademarks

The MOXA logo is a registered trademark of Moxa Inc.

All other trademarks or registered marks in this manual belong to their respective manufacturers.

Disclaimer

Information in this document is subject to change without notice and does not represent a commitment on the part of Moxa.

Moxa provides this document as is, without warranty of any kind, either expressed or implied, including, but not limited to, its particular purpose. Moxa reserves the right to make improvements and/or changes to this manual, or to the products and/or the programs described in this manual, at any time.

Information provided in this manual is intended to be accurate and reliable. However, Moxa assumes no responsibility for its use, or for any infringements on the rights of third parties that may result from its use.

This product might include unintentional technical or typographical errors. Changes are periodically made to the information herein to correct such errors, and these changes are incorporated into new editions of the publication.

Technical Support Contact Information

www.moxa.com/support

Moxa Americas

Toll-free: 1-888-669-2872

Tel: +1-714-528-6777

Fax: +1-714-528-6778

Moxa Europe

Tel: +49-89-3 70 03 99-0

Fax: +49-89-3 70 03 99-99

Moxa China (Shanghai office)

Toll-free: 800-820-5036

Tel: +86-21-5258-9955

Fax: +86-10-6872-3958

Moxa Asia-Pacific

Tel: +886-2-8919-1230

Fax: +886-2-8919-1231

Table of Contents

| | |
|--|------------|
| 1. Introduction | 1-1 |
| Overview | 1-2 |
| Package Checklist | 1-2 |
| Product Features | 1-2 |
| Product Specifications | 1-3 |
| 2. Getting Started | 2-1 |
| NPort 5150AI-M12 Series Appearance | 2-2 |
| NPort 5250AI-M12 Series Appearance | 2-2 |
| NPort 5450AI-M12 Series Appearance | 2-3 |
| Connecting the Hardware | 2-3 |
| Wiring Requirements | 2-3 |
| Hardware Installation Procedure | 2-4 |
| Panel/Wall Mounting | 2-4 |
| DIN-Rail Mounting (optional) | 2-4 |
| Connecting the Power | 2-5 |
| Connecting to the Network | 2-5 |
| Connecting to a Serial Device | 2-6 |
| LED Indicators | 2-6 |
| 3. Initial IP Address Configuration | 3-1 |
| Initializing the NPort's IP Address | 3-2 |
| Factory Default IP Address | 3-2 |
| NPort Administration Suite | 3-2 |
| ARP | 3-2 |
| Telnet Console | 3-3 |
| Serial Console (19200, n, 8, 1) | 3-6 |
| 4. Choosing the Proper Operation Mode | 4-1 |
| Overview | 4-2 |
| Real COM Mode | 4-2 |
| RFC2217 Mode | 4-3 |
| TCP Server Mode | 4-3 |
| TCP Client Mode | 4-3 |
| UDP Mode | 4-4 |
| Pair Connection Mode | 4-4 |
| Ethernet Modem Mode | 4-4 |
| Reverse Telnet Mode | 4-5 |
| Disabled Mode | 4-5 |
| 5. Web Console Configuration | 5-1 |
| Opening Your Browser | 5-2 |
| Quick Setup | 5-4 |
| Export/Import | 5-6 |
| Basic Settings | 5-6 |
| Network Settings | 5-7 |
| LLDP Settings | 5-10 |
| Serial Settings | 5-10 |
| Operating Settings | 5-12 |
| Real COM Mode | 5-13 |
| RFC2217 Mode | 5-16 |
| TCP Server Mode | 5-18 |
| TCP Client Mode | 5-21 |
| UDP Mode | 5-25 |
| Pair Connection Mode | 5-27 |
| Ethernet Modem Mode | 5-29 |
| Reverse Telnet Mode | 5-31 |
| Disabled Mode | 5-32 |
| Accessible IP Settings | 5-33 |
| Auto Warning Settings | 5-34 |
| Auto warning: Email and SNMP trap | 5-34 |
| Event Type | 5-35 |
| Upgrade Firmware | 5-37 |
| Monitor | 5-37 |
| Monitor Line | 5-37 |
| Monitor Async | 5-38 |
| Monitor Async-Settings | 5-38 |
| Change Password | 5-39 |
| Load Factory Default | 5-39 |
| Save/Restart | 5-40 |

| | | |
|-----------|---|------------|
| 6. | Configuring NPort Administrator | 6-1 |
| | Overview | 6-2 |
| | Installing NPort Administrator | 6-2 |
| | Configuration | 6-4 |
| | Broadcast Search | 6-5 |
| | Unlock Password Protection | 6-6 |
| | Configuring the NPort 5000AI-M12 | 6-7 |
| | Upgrading the Firmware..... | 6-9 |
| | Export Configuration | 6-10 |
| | Import Configuration | 6-10 |
| | Monitor | 6-11 |
| | Port Monitor | 6-15 |
| | COM Mapping..... | 6-15 |
| | On-line COM Mapping | 6-16 |
| | Off-line COM Mapping | 6-19 |
| | COM Grouping..... | 6-20 |
| | Creating a COM Group | 6-20 |
| | Deleting a COM Group | 6-22 |
| | Adding a Port to a COM Group | 6-24 |
| | Removing a Port from a COM Group | 6-25 |
| | Modify Ports in a COM Group | 6-27 |
| | Changing the COM Number of a COM Group | 6-27 |
| | Changing Advanced Settings and Serial Parameters of the COM Group..... | 6-29 |
| | Changing the Serial Port Specified as Signal Port for the COM Group | 6-31 |
| | IP Address Report..... | 6-32 |
| 7. | IP Serial Library | 7-1 |
| | Overview | 7-2 |
| | IP Serial Library Function Groups..... | 7-3 |
| | Example Program | 7-3 |
| A. | Pinouts and Cable Wiring | A-1 |
| | Pin Assignments and Cable Wiring | A-2 |
| | Ethernet M12..... | A-2 |
| | Power M12 | A-2 |
| | RS-232/422/485 (male DB9) Pinouts..... | A-2 |
| | Serial Cable Wiring Diagrams | A-3 |
| | Female DB9 to Male DB9..... | A-3 |
| B. | Well Known Port Numbers | B-1 |
| C. | SNMP Agents with MIB II & RS-232 Like Groups..... | C-1 |
| D. | Auto IP Report Protocol | D-1 |
| E. | Compliance Notice..... | E-1 |

Introduction

Welcome to the NPort 5000AI-M12 Series of industrial serial device servers. There are a total of nine models in this series and they will be referred to collectively as the "NPort 5000AI-M12 Series" in this manual.

The nine models in the NPort 5000AI-M12 Series are:

| | |
|----------------------------|--|
| NPort 5150AI-M12 | 1-port RS-232/422/485 Device Server , 1 x 10/100BaseT(X) with M12 Connector, M12 Power Input, -25 to 55°C |
| NPort 5150AI-M12-CT | 1-port RS-232/422/485 Device Server , 1 x 10/100BaseT(X) with M12 Connector, M12 Power Input, -25 to 55°C, Conformal Coating |
| NPort 5150AI-M12-T | 1-port RS-232/422/485 Device Server , 1 x 10/100BaseT(X) with M12 Connector, M12 Power Input, -40 to 75°C |
| NPort 5250AI-M12 | 2-port RS-232/422/485 Device Server , 1 x 10/100BaseT(X) with M12 Connector, M12 Power Input, -25 to 55°C |
| NPort 5250AI-M12-CT | 2-port RS-232/422/485 Device Server , 1 x 10/100BaseT(X) with M12 Connector, M12 Power Input, -25 to 55°C, Conformal Coating |
| NPort 5250AI-M12-T | 2-port RS-232/422/485 Device Server , 1 x 10/100BaseT(X) with M12 Connector, M12 Power Input, -40 to 75°C |
| NPort 5450AI-M12 | 4-port RS-232/422/485 Device Server , 1 x 10/100BaseT(X) with M12 Connector, M12 Power Input, -25 to 55°C |
| NPort 5450AI-M12-CT | 4-port RS-232/422/485 Device Server , 1 x 10/100BaseT(X) with M12 Connector, M12 Power Input, -25 to 55°C, Conformal Coating |
| NPort 5450AI-M12-T | 4-port RS-232/422/485 Device Server , 1 x 10/100BaseT(X) with M12 Connector, M12 Power Input, -40 to 75°C |

The following topics are covered in this chapter:

- **Overview**
- **Package Checklist**
- **Product Features**
- **Product Specifications**

Overview

NPort 5000AI-M12 device server is designed to make serial devices network-ready in an instant and is compliant with EN 50155 and EN 50121-4 standards, allowing them to perform reliably in rolling stock and wayside applications where high level vibration is present. Use the NPort 5000AI-M12 device servers to give your PC software direct access to serial devices from anywhere on the network.

Package Checklist

Before installing the NPort 5000AI-M12 series device servers, verify that the package contains the following items:

Standard Accessories

- 1 NPort 5000AI-M12 serial device server
- Documentation and Software CD
- Quick Installation Guide (printed)
- Warranty Card

Optional Accessories

- DR-45-24 45W/2A DIN-Rail 24 VDC Power Supply with universal 85 to 264 VAC input
- DR-75-24 75W/3.2A DIN-Rail 24 VDC Power Supply with universal 85 to 264 VAC input
- DR-120-24 120W/5A DIN-Rail 24 VDC Power Supply with 88 to 132 VAC/176 to 264 VAC input
- DK-TN-5308 DIN-Rail kit

NOTE: Notify your sales representative if any of the above items is missing or damaged.

Product Features

The NPort 5000AI-M12 Series are the world's first EN 50155 compliant device servers and includes:

- Speedy 3-step web-based configuration
- COM port grouping and UDP multicast applications
- Real COM/TTY drivers for Windows and Linux
- Standard TCP/IP interface and versatile TCP and UDP operation modes
- Compliant with EN 50121-4 and essential sections of EN 50155
- M12 connector and IP40 metal housing
- 2 KV isolation for serial signals

Product Specifications

Ethernet Interface

Number of Ports: 1

Speed: 10/100 Mbps, auto MDI/MDIX

Connector: M12

Serial Interface

Number of Ports: 1/2/4

Serial Standards: RS-232/422/485

Connector: DB9 male

Serial Line Protection: 15 KV ESD protection for all signals

RS-485 Data Direction Control: ADDC® (automatic data direction control)

Serial Communication Parameters

Data Bits: 5, 6, 7, 8

Stop Bits: 1, 1.5, 2

Parity: None, Even, Odd, Space, Mark

Flow Control: RTS/CTS and DTR/DSR (RS-232 only), XON/XOFF

Baudrate: 50 to 921.6 Kbps

Serial Signals

RS-232: TxD, RxD, RTS, CTS, DTR, DSR, DCD, GND

RS-422: Tx+, Tx-, Rx+, Rx-, GND

RS-485-4w: Tx+, Tx-, Rx+, Rx-, GND

RS-485-2w: Data+, Data-, GND

Software

Network Protocols: ICMP, IP, TCP, UDP, DHCP, BOOTP, Telnet, DNS, SNMP V1, HTTP, SMTP, IGMP V1/2, LLDP

Configuration Options: Web Console (with new Quick Setup), Telnet Console, Windows Utility

Windows Real COM Drivers: Windows 98/ME/NT/2000, Windows XP/2003/Vista/2008/7 x86/x64

Fixed TTY Drivers: SCO Unix, SCO OpenServer, UnixWare 7, UnixWare 2.1, SVR 4.2, QNX 4.25, QNX 6, Solaris 10, FreeBSD, AIX 5.x, HP-UX 11i, Mac 10.3

Linux Real TTY Drivers: Linux kernel 2.4.x, 2.6.x, 3.x

Physical Characteristics

Housing: Metal, IP40 protection

Weight: 0.56 kg (1.23 lb)

Dimensions: 80 x 216.6 x 52.9 mm (3.15 x 8.53 x 2.08 in)

Environmental Limits

Operating Temperature:

Standard Models: -25 to 55°C (-13 to 131°F)

Wide Temp. Models: -40 to 75°C (-40 to 167°F) EN 50155 Compliant

Ambient Relative Humidity: 5 to 95% (non-condensing)

Storage Temperature: -40 to 85°C (-40 to 185°F) EN 50155 Compliant

Power Requirements

Input Voltage: 12 to 48 VDC

Power Consumption:

NPort 5150AI-M12: 310mA @12V

NPort 5150AI-M12-CT: 310mA @12V

NPort 5150AI-M12-T: 310mA @12V

NPort 5250AI-M12: 360mA @12V

NPort 5250AI-M12-CT: 360mA @12V

NPort 5250AI-M12-T: 360mA @12V

NPort 5450AI-M12: 440mA @12V

NPort 5450AI-M12-CT: 440mA @12V

NPort 5450AI-M12-T: 440mA @12V

Connector: M12

For railway rolling stock applications, the device must use a galvanically isolated power supply that is compliant with the EN 50155 standard.

Standards and Certifications

EMI: EN 55022 Class A, FCC Part 15 Subpart B Class A

Safety: UL 60950-1, EN 60950-1

EMC: EC, FCC

EMS: EN 55024

Rail Traffic: EN 50155, EN 50121-4

Reliability

Alert Tools: Built-in buzzer and RTC

Automatic Reboot Trigger: Built-in WDT (watchdog timer)

MTBF (mean time between failures):

NPort 5150AI-M12: 789,341 hrs

NPort 5250AI-M12: 639,622 hrs

NPort 5450AI-M12: 467,777 hrs

Warranty

Warranty Period: 5 years

Details: See www.moxa.com/warranty

Getting Started

In this chapter, we give instructions on installing NPort 5000AI-M12 device servers. Software installation is covered in subsequent chapters.

The following topics are covered in this chapter:

- ❑ **NPort 5150AI-M12 Series Appearance**
- ❑ **NPort 5250AI-M12 Series Appearance**
- ❑ **NPort 5450AI-M12 Series Appearance**
- ❑ **Connecting the Hardware**
 - Wiring Requirements
- ❑ **Hardware Installation Procedure**
 - Panel/Wall Mounting
 - DIN-Rail Mounting (optional)
 - Connecting the Power
 - Connecting to the Network
 - Connecting to a Serial Device
 - LED Indicators

NPort 5150AI-M12 Series Appearance

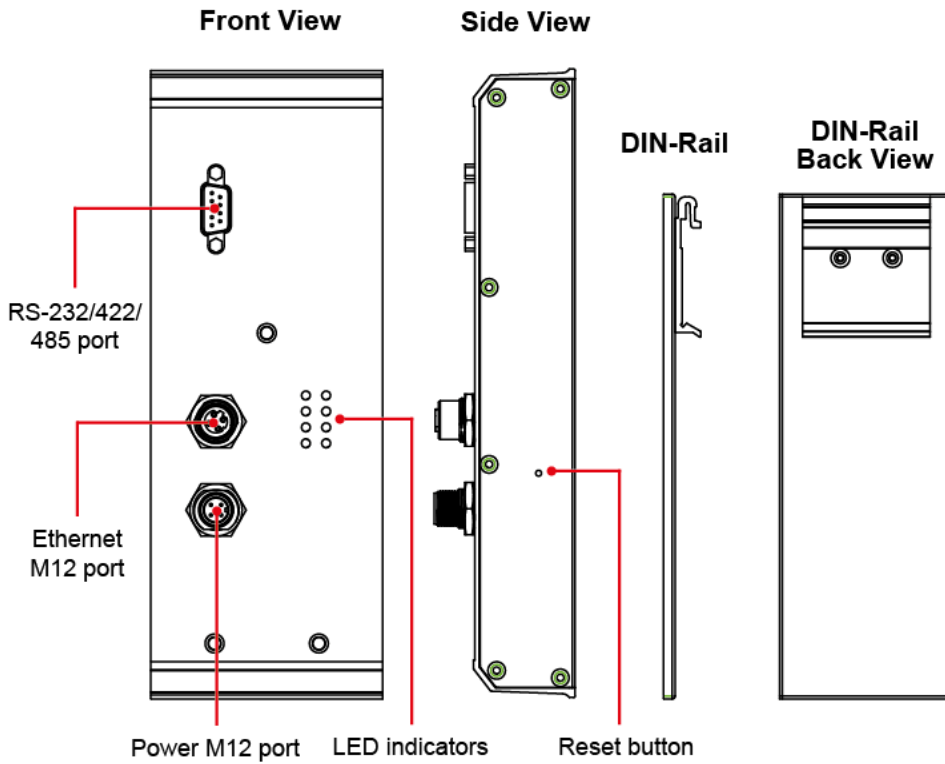

NPort 5250AI-M12 Series Appearance

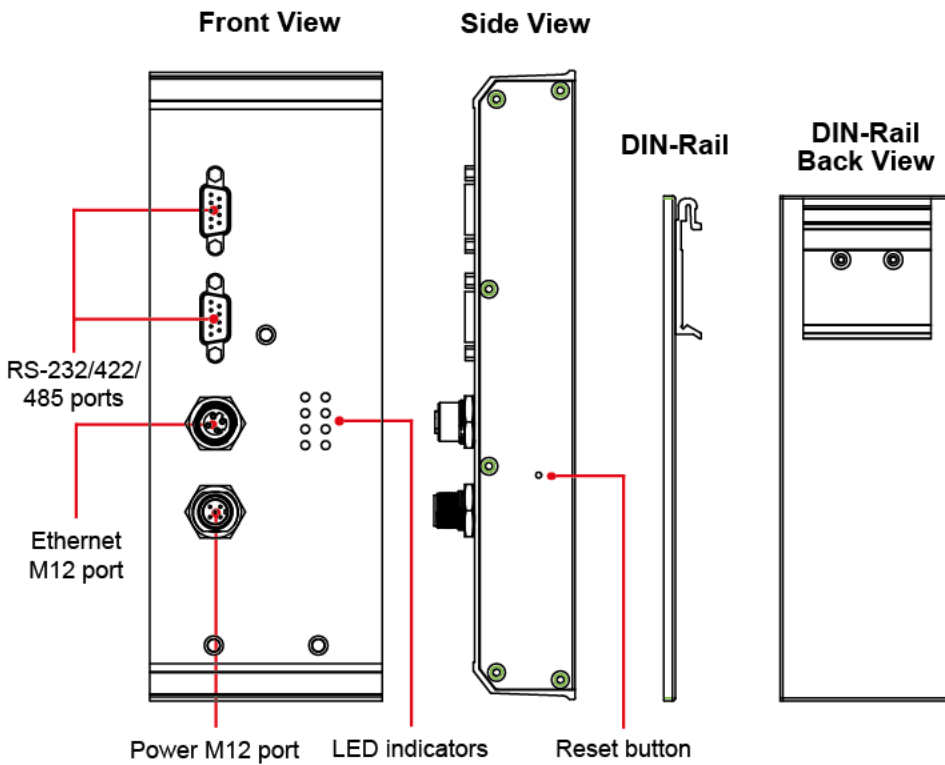

NPort 5450AI-M12 Series Appearance

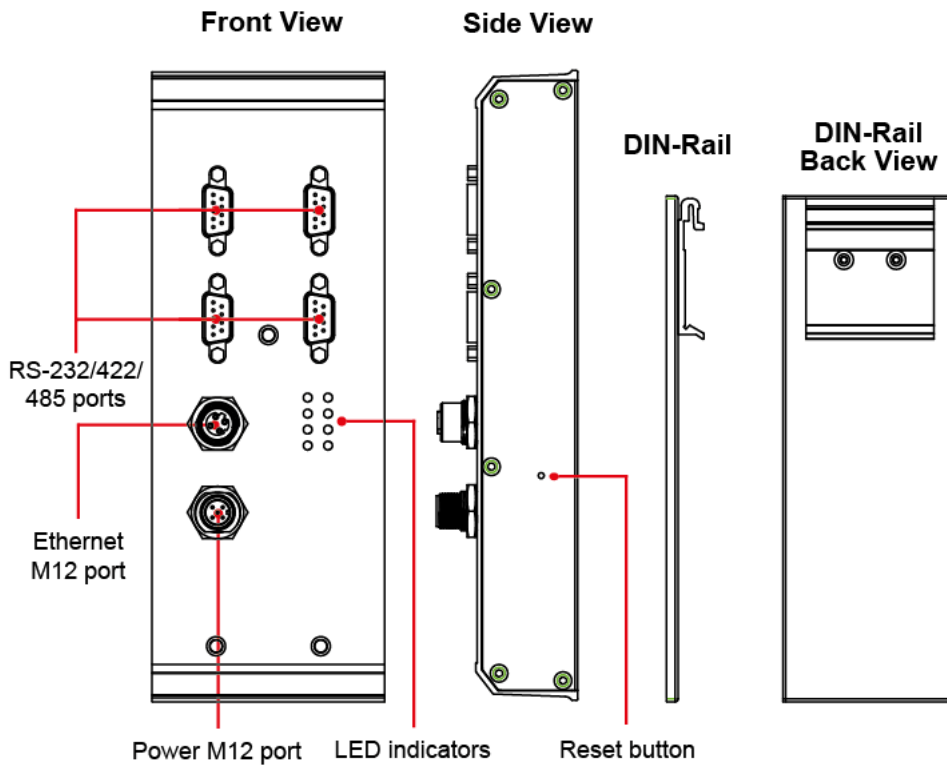

Connecting the Hardware

This section describes how to connect NPort 5000AI-M12 to serial devices for first time testing purposes. We cover **Wiring Requirements**, **Connecting the Power**, **Connecting to the Network**, **Connecting to a Serial Device**, and **LED Indicators**.

Wiring Requirements



ATTENTION

Safety First!

Be sure to disconnect the power cord before installing and/or wiring your NPort 5000AI-M12 Series.

Wiring Caution!

Calculate the maximum possible current in each power wire and common wire. Observe all electrical codes dictating the maximum current allowable for each wire size.

If the current goes above the maximum ratings, the wiring could overheat, causing serious damage to your equipment.

Temperature Caution!

Please take care when handling NPort 5000AI-M12. When plugged in, NPort 5000AI-M12's internal components generate heat, and consequently the casing may feel hot to the touch. When installed with other components, make sure that there is at least 2 cm clearance on all sides of NPort 5000AI-M12 in order to allow proper heat dissipation.

You should observe the following:

- Use separate paths to route wiring for power and devices. If power wiring and device wiring paths must cross, make sure the wires are perpendicular at the intersection point.
NOTE: Do not run signal or communication wiring and power wiring in the same wire conduit. To avoid interference, wires with different signal characteristics should be routed separately.
- You can use the type of signal transmitted through a wire to determine which wires should be kept separate. The rule of thumb is that wiring that shares similar electrical characteristics can be bundled together.
- Keep input wiring and output wiring separate.
- Where necessary, it is strongly advised that you label wiring to all devices in the system.

Hardware Installation Procedure

Panel/Wall Mounting

Mounting the NPort 5000AI-M12 on the wall requires 3 screws. Please use the 3 screws included.

STEP 1: Prepare the 3 screw holes on the wall according to the positions of the 3 screw holes on the device server shown on the mounting dimension diagram.

STEP 2: Use one screw to go through the top-middle screw hole on the device server and screw it into the wall.

STEP 3: Screw in the remaining 2 screws through the bottom-left and bottom-right holes on the device server to the wall.

NOTE Please use the screws (M3 x 40 mm) included.

DIN-Rail Mounting (optional)

With the optional DIN-Rail mounting kit DK-TN-5308 (must be purchased separately), you can mount the NPort 5000AI-M12 on a 35mm DIN-Rail.

STEP 1: Fix the DIN-Rail attachment plate onto the rear panel of the device server as shown in the figure at the right.

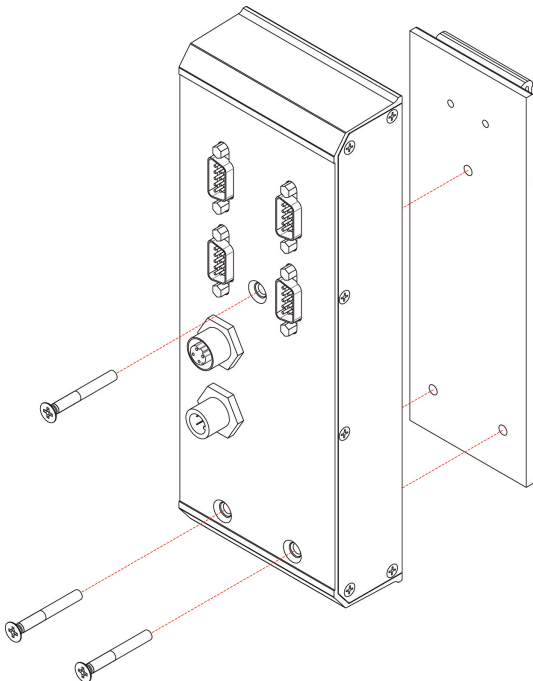

STEP 2: Position the NPort 5000AI-M12 on the DIN-Rail, tilting to hook clamps over the top edge of the rail.

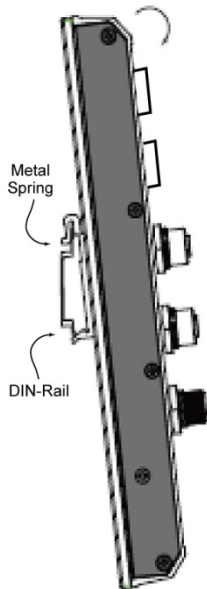

STEP 3: Swing the device server down fully onto the DIN-Rail until both clamps completely latch.

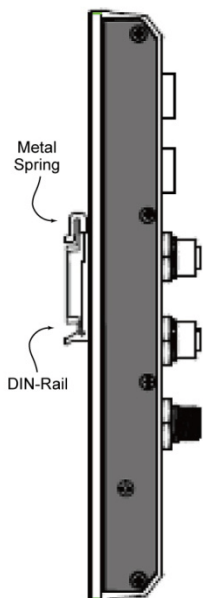

Connecting the Power

Connect the power line with the NPort 5000AI-M12's M12 connector. If the power is properly supplied, the "Ready" LED will show a solid red color until the system is ready, at which time the "Ready" LED will change to a green color.

Connecting to the Network

Connect one end of the Ethernet cable to the NPort 5000AI-M12's 10/100M Ethernet port and the other end of the cable to the Ethernet network. If the cable is properly connected, the NPort 5000AI-M12 will indicate a valid connection to the Ethernet in the following ways:

- The Ethernet LED maintains a solid green color when connected to a 100 Mbps Ethernet network.
- The Ethernet LED maintains a solid orange color when connected to a 10 Mbps Ethernet network.
- The Ethernet LED will flash when Ethernet packets are being transmitted or received.

Connecting to a Serial Device

Connect the serial data cable between NPort 5000AI-M12 and the serial device. Serial data cables are optional accessories for NPort.

LED Indicators

The top panels of all NPort 5000AI-M12 have four LED indicators, as described in the following table.

| Name | Color | Function | |
|-------------------|--|---|--|
| PWR | green | Power is being supplied to the power input. | |
| Ready | red | Steady on: | Power is on and NPort is booting up. |
| | | Blinking: | Indicates an IP conflict, or DHCP/BOOTP server did not respond properly. |
| | green | Steady on: | Power is on and NPort is functioning normally. |
| | | Blinking: | The NPort has been located by NPort Administrator's Location function. |
| off | Power is off, or a power error condition exists. | | |
| 10M, 100M | orange | 10 Mbps Ethernet connection. | |
| | green | 100 Mbps Ethernet connection. | |
| | off | Ethernet cable is disconnected. | |
| P1, P2, P3, P4 | orange | Serial port is receiving data. | |
| | green | Serial port is transmitting data. | |
| | off | No data is being transmitted or received through the serial port. | |

Initial IP Address Configuration

When setting up your NPort 5000AI-M12 for the first time, the first thing you should do is configure the IP address. This chapter introduces the methods that can be used to configure the device server's IP address. **Select one of the initial IP Address configuration methods to configure NPort 5000AI-M12's IP Address.** For more details about network settings, see the **Network Settings** section from **Chapter 5, Web Console Configuration**.

The following topics are covered in this chapter:

- ❑ **Initializing the NPort's IP Address**
- ❑ **Factory Default IP Address**
- ❑ **NPort Administration Suite**
- ❑ **ARP**
- ❑ **Telnet Console**
- ❑ **Serial Console (19200, n, 8, 1)**

Initializing the NPort's IP Address

1. Determine whether your NPort 5000AI-M12 needs to use a Static IP or Dynamic IP (either DHCP or BOOTP application).
2. **If the NPort 5000AI-M12 is used in a Static IP environment**, you can use NPort Administration Suite, ARP, Web Console, Telnet Console, or Serial Console to configure the new IP address.
3. **If the NPort 5000AI-M12 is used in a Dynamic IP environment**, you can use NPort 5000AI-M12 Administration Suite, Web Console, Telnet Console, or Serial Console to configure NPort 5000AI-M12 to get an IP address dynamically with DHCP, DHCP/BOOTP, or BOOTP.



ATTENTION

Consult your network administrator on how to reserve a fixed IP address for your NPort 5000AI-M12 in the MAC-IP mapping table when using a DHCP Server or BOOTP Server. In most applications, you should assign a fixed IP address to your NPort 5000AI-M12.

Factory Default IP Address

NPort 5000AI-M12 products are configured with the following default private IP address:

Default IP address: 192.168.127.254

(IP addresses of the form 192.168.xxx.xxx are referred to as private IP addresses, since it is not possible to directly access a device configured with a private IP address from a public network. For example, you would not be able to ping such a device from an outside Internet connection. NPort 5000AI-M12 applications that require sending data over a public network, such as the Internet, require setting up the server with a valid public IP address, which can be leased from a local ISP.)

NPort Administration Suite

NPort Administration Suite consists of some useful utility programs that are used to configure and manage your NPort 5000AI-M12.

See Chapter 5 for details on how to install NPort Administration Suite, and how to use this suite of useful utilities to set up IP addresses and configure your NPort 5000AI-M12 Series serial device servers.

ARP

You can make use of the ARP (Address Resolution Protocol) command to set up an IP address for your NPort 5000AI-M12. The ARP command tells your computer to associate the NPort 5000AI-M12's MAC address with the intended IP address. You must then use Telnet to access the NPort 5000AI-M12, at which point the device server's IP address will be reconfigured.



ATTENTION

In order to use this setup method, both your computer and NPort 5000AI-M12 must be connected to the same LAN. Or, you may use a cross-over Ethernet cable to connect the NPort 5000AI-M12 directly to your computer's Ethernet card. Before executing the ARP command, your NPort 5000AI-M12 must be configured with the factory default IP address (192.168.127.254), and your computer and the NPort 5000AI-M12 must be on the same subnet.

Take the following steps to use ARP to configure the IP address:

1. Obtain a valid IP address for your NPort 5000AI-M12 from your network administrator.
2. Obtain the NPort 5000AI-M12's MAC address from the label on its bottom panel.
3. Execute the 'arp -s' command from your computer's MS-DOS prompt by typing:

```
arp -s 192.168.200.100 00-90-E8-xx-xx-xx
```

This is where 192.168.200.100 is the new IP address and 00-90-E8-xx-xx-xx is the MAC address for your NPort 5000AI-M12. (Be sure to use the actual IP address and MAC address for your NPort 5000AI-M12.)

4. Next, execute a special Telnet command by typing:

```
telnet 192.168.200.100 6000
```

After issuing this command, a Connect failed message will appear, as shown here. After the NPort reboots, its IP address should be updated to the new address, and you can reconnect using either Telnet, Web, or Administrator to check that the update was successful.



Telnet Console

Depending on how your computer and network are configured, you may find it convenient to use network access to set up your NPort 5000AI-M12's IP address. This can be done using Telnet.



ATTENTION

Figures in this chapter were generated using the NPort 5000AI-M12I.

1. From the Windows desktop, click on **Start** and then select **Run**.
2. Type **telnet 192.168.127.254** (use the correct IP address if different from the default) in the Open text input box, and then click **OK**.

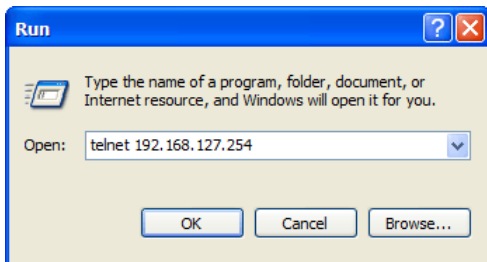

3. When the Telnet window opens, if you are prompted to input the Console password, input the password and then press **Enter**.

Note that this page will only appear if the NPort is password protected.

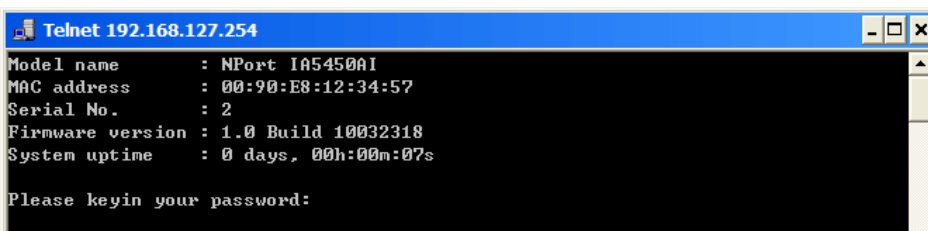

4. Type **2** to select Network settings, and then press **Enter**.

```
<< Main menu >>
(1) Basic settings
(2) Network settings
(3) Serial settings
(4) Operating settings
(5) Accessible IP settings
(6) Auto warning settings
(7) Monitor
(8) Ping
(9) Change password
(a) Load factory default
(v) View settings
(s) Save/Restart
(q) Quit

Key in your selection: 2_
```

5. Type **1** to select IP address and then press **Enter**.

```
<< Main menu->Network settings >>
(1) IP address
(2) Netmask
(3) Gateway
(4) IP configuration
(5) DNS server 1
(6) DNS server 2
(7) SNMP
(8) SNMP community name
(9) SNMP contact
(a) SNMP location
(b) Auto report to IP
(c) Auto report to UDP port
(d) Auto report period
(e) LLDP
(f) LLDP Message Transmit Interval
(v) View settings
(m) Back to main menu
(q) Quit

Key in your selection: 1
```

6. Use the **Backspace** key to erase the current IP address, type in the **new IP address**, and then press **Enter**.

```
<< Main menu->Network settings >>
(1) IP address
(2) Netmask
(3) Gateway
(4) IP configuration
(5) DNS server 1
(6) DNS server 2
(7) SNMP
(8) SNMP community name
(9) SNMP contact
(a) SNMP location
(b) Auto report to IP
(c) Auto report to UDP port
(d) Auto report period
(e) LLDP
(f) LLDP Message Transmit Interval
(v) View settings
(m) Back to main menu
(q) Quit

Key in your selection: 1
IP address: 192.168.127.253_
```

7. Press any key to continue...

```

<< Main menu->Network settings >>
(1) IP address
(2) Netmask
(3) Gateway
(4) IP configuration
(5) DNS server 1
(6) DNS server 2
(7) SNMP
(8) SNMP community name
(9) SNMP contact
(a) SNMP location
(b) Auto report to IP
(c) Auto report to UDP port
(d) Auto report period
(e) LLDP
(f) LLDP Message Transmit Interval
(v) View settings
(m) Back to main menu
(q) Quit

Key in your selection: 1
IP address: 192.168.127.253
Set IP address success

Press any key to continue..._

```

8. Type **m** and then press **Enter** to return to the main menu.

```

<< Main menu->Network settings >>
(1) IP address
(2) Netmask
(3) Gateway
(4) IP configuration
(5) DNS server 1
(6) DNS server 2
(7) SNMP
(8) SNMP community name
(9) SNMP contact
(a) SNMP location
(b) Auto report to IP
(c) Auto report to UDP port
(d) Auto report period
(e) LLDP
(f) LLDP Message Transmit Interval
(v) View settings
(m) Back to main menu
(q) Quit

Key in your selection: m_

```

9. Type **s** and then press **Enter** to Save/Restart the system.

```

Model name       : NPort IA5450AI
MAC address      : 00:90:E8:12:34:57
Serial No.       : 2
Firmware version : 1.0 Build 10032318
System uptime    : 0 days, 00h:06m:48s

<< Main menu >>
(1) Basic settings
(2) Network settings
(3) Serial settings
(4) Operating settings
(5) Accessible IP settings
(6) Auto warning settings
(7) Monitor
(8) Ping
(9) Change password
(a) Load factory default
(v) View settings
(s) Save/Restart
(q) Quit

Key in your selection: s

```

- Type **y** and then press **Enter** to save the new IP address and restart the NPort 5000AI-M12.

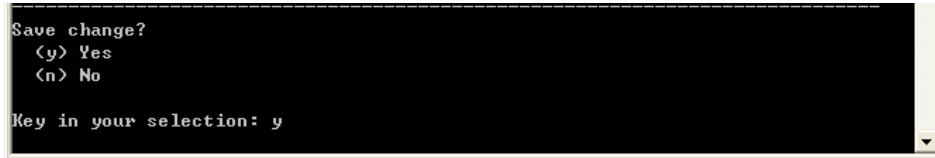

Serial Console (19200, n, 8, 1)

You may use the RS-232 console port to set up the IP address for NPort 5000AI-M12. We suggest using PComm Terminal Emulator, which is available free of charge as part of the PComm Lite program suite, to carry out the installation procedure, although other similar utilities may also be used.



ATTENTION

The **Serial Console** is at serial port 1 of the NPort 5000AI-M12 Series, with RS-232 mode.

Before you start to configure the NPort 5000AI-M12 via serial console, turn off the power and connect the serial cable from NPort 5000AI-M12 to your computer's serial port.

- Connect NPort 5000AI-M12's serial port 1 directly to your computer's male RS-232 serial port.
- From the Windows desktop click on **Start** → **Programs** → **PComm Lite** → **Terminal Emulator**.
- When the PComm Terminal Emulator window opens, first click on the **Port Manager** menu item and select **Open**, or simply click on the Open icon.

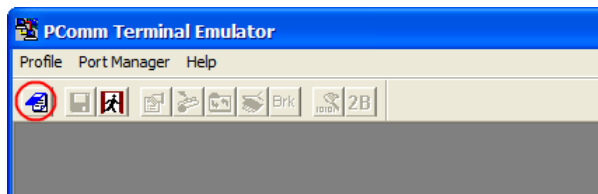

- The Property window opens automatically. From the **Communication Parameter** page, select the appropriate COM port for the connection, COM1 in this example, and 19200 for Baud Rate, 8 for Data Bits, None for Parity, and 1 for Stop Bits.
- From the **Property** window's Terminal page, select **ANSI** or **VT100** for **Terminal Type** and then click **OK**. Note: If you select Dumb Terminal as the terminal type, some of the console functions—especially the "Monitor" function—may not work properly.

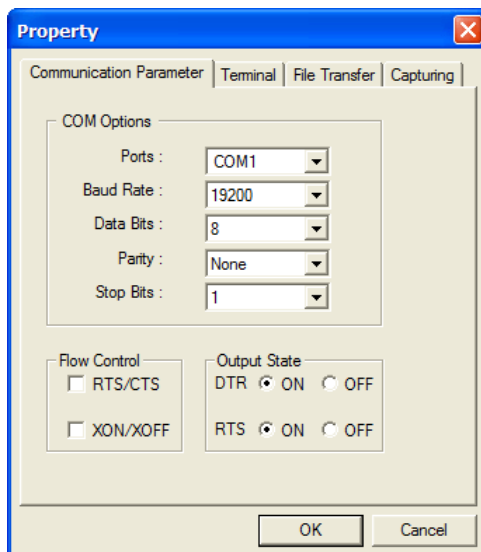

- 6. Press the "`" key continuously and then power on the NPort 5000AI-M12.

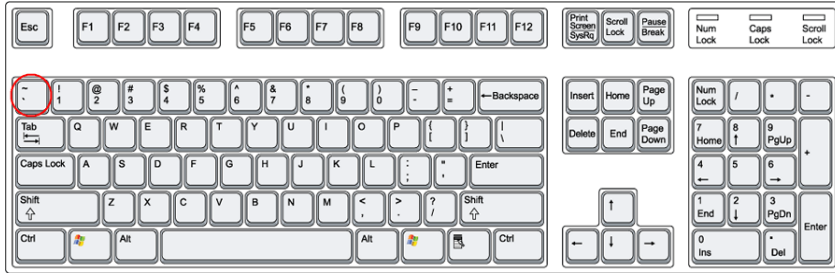

- 7. The NPort 5000AI-M12 will automatically switch from data mode to console mode as it receives a continuous string of "`" characters.
- 8. Input the **password** when prompted. Note that this page will only appear when the NPort 5000AI-M12 has been set up for password protection.

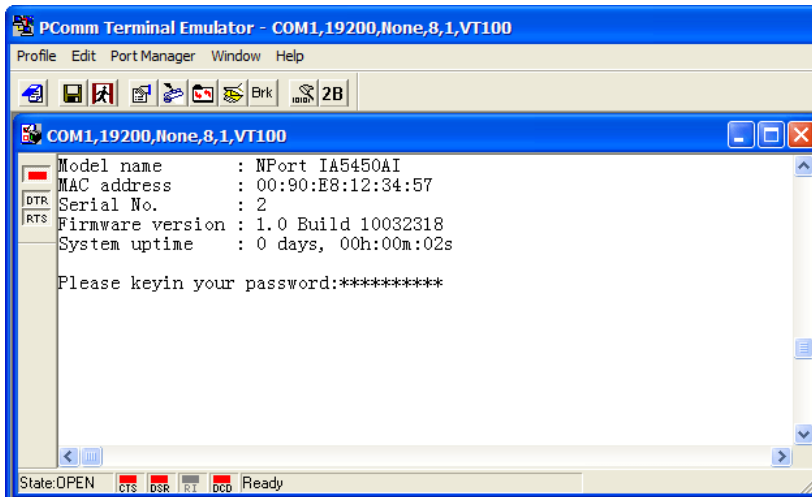

- 9. Start configuring the IP address under Network Settings. Refer to step 4 in the Telnet Console section for the rest of the IP settings.

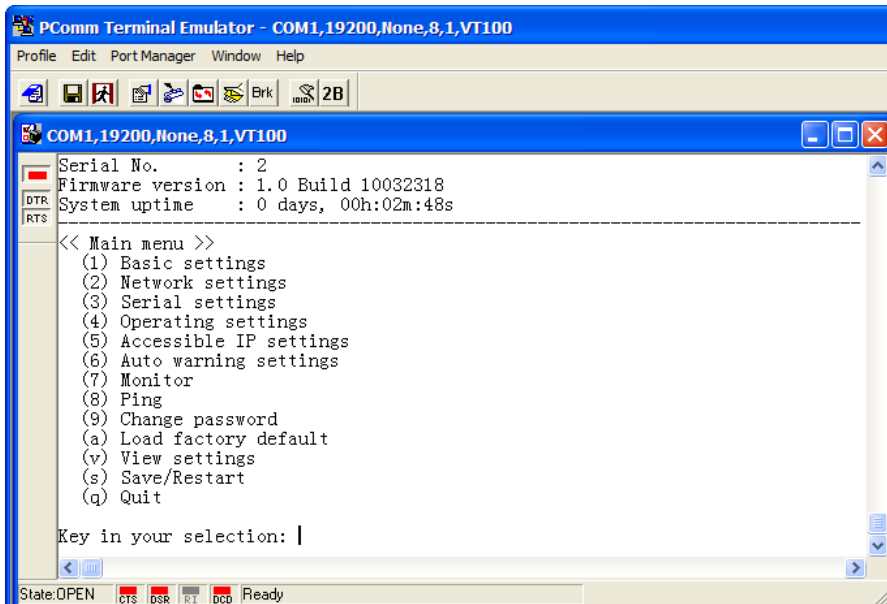

Choosing the Proper Operation Mode

In this chapter, we describe the various NPort 5000AI-M12 operation modes. The options include an operation mode that uses a driver installed on the host computer, and operation modes that rely on TCP/IP socket programming concepts. After choosing the proper operation mode in this chapter, refer to Chapter 5 for detailed configuration parameter definitions.

The following topics are covered in this chapter:

- ❑ **Overview**
- ❑ **Real COM Mode**
- ❑ **RFC2217 Mode**
- ❑ **TCP Server Mode**
- ❑ **TCP Client Mode**
- ❑ **UDP Mode**
- ❑ **Pair Connection Mode**
- ❑ **Ethernet Modem Mode**
- ❑ **Reverse Telnet Mode**
- ❑ **Disabled Mode**

Overview

NPort 5000AI-M12 Serial Device Servers network-enable traditional RS-232/422/485 devices, in which a Serial Device Server is a tiny computer equipped with a CPU, real-time OS, and TCP/IP protocols that can bi-directionally translate data between the serial and Ethernet formats. Your computer can access, manage, and configure remote facilities and equipment over the Internet from anywhere in the world.

Traditional SCADA and data collection systems rely on serial ports (RS-232/422/485) to collect data from various kinds of instruments. Since NPort 5000AI-M12 Serial Device Servers network-enable instruments equipped with an RS-232/422/485 communication port, your SCADA and data collection system will be able to access all instruments connected to a standard TCP/IP network, regardless of whether the devices are used locally or at a remote site.

NPort 5000AI-M12 is an external IP-based network device that allows you to expand the number of serial ports for a host computer on demand. As long as your host computer supports the TCP/IP protocol, you won't be limited by the host computer's bus limitation (such as ISA or PCI), or lack of drivers for various operating systems.

In addition to providing socket access, NPort 5000AI-M12 also comes with a Real COM/TTY driver that transmits all serial signals intact. This means that your existing COM/TTY-based software can be preserved, without needing to invest in additional software.

Three different Socket Modes are available: TCP Server, TCP Client, and UDP Server/Client. The main difference between the TCP and UDP protocols is that TCP guarantees delivery of data by requiring the recipient to send an acknowledgement to the sender. UDP does not require this type of verification, making it possible to offer speedier delivery. UDP also allows unicast or multicast of data to only one IP or groups of IP addresses.

Real COM Mode

NPort 5000AI-M12 comes equipped with COM drivers that work with Windows 98/ME/NT/2000, Windows XP/2003/Vista/2008/7 x86/x64 systems, and also TTY drivers for Linux or Unix systems. The driver establishes a transparent connection between host and serial device by mapping the IP:Port of the NPort 5000AI-M12's serial port to a local COM/TTY port on the host computer. Real COM Mode also supports up to 8 simultaneous connections, so that multiple hosts can collect data from the same serial device at the same time.

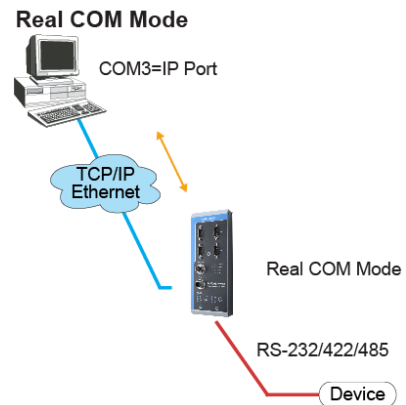



ATTENTION

The driver used for Real COM Mode comes with the NPort Administrator. The driver is installed automatically on your computer when you install NPort Administration Suite.

One of the major conveniences of using Real COM Mode is that Real COM Mode allows users to continue using RS-232/422/485 serial communications software that was written for pure serial communications applications. The driver intercepts data sent to the host's COM port, packs it into a TCP/IP packet, and then redirects it through the host's Ethernet card. At the other end of the connection, the NPort 5000AI-M12 accepts the Ethernet frame, unpacks the TCP/IP packet, and then transparently sends it to the appropriate serial device attached to one of the NPort 5000AI-M12's serial ports.



ATTENTION

Real COM Mode allows several hosts to have access control over the same NPort 5000AI-M12. The driver that comes with your NPort 5000AI-M12 controls host access to attached serial devices by checking the host’s IP address. Refer to Accessible IP Settings in Chapter 5 for more details.

RFC2217 Mode

RFC2217 mode is similar to Real COM mode in that a driver is used to establish a transparent connection between a host computer and a serial device by mapping the serial port on the NPort 5000AI-M12 to a local COM port on the host computer. RFC2217 defines general COM port control options based on the Telnet protocol. Third party drivers that support RFC2217 are widely available on the Internet and can be used to implement Virtual COM mapping to your NPort 5000AI-M12 serial port(s).

TCP Server Mode

In TCP Server mode, NPort 5000AI-M12 is configured with a unique IP:Port address on a TCP/IP network. NPort 5000AI-M12 waits passively to be contacted by the host computer, allowing the host computer to establish a connection with and get data from the serial device. This operation mode also supports up to 8 simultaneous connections, so that multiple hosts can collect data from the same serial device—at the same time.

As illustrated in the figure, data transmission proceeds as follows:

1. The host requests a connection from the NPort 5000AI-M12 configured for TCP Server Mode.
2. Once the connection is established, data can be transmitted in both directions—from the host to the NPort 5000AI-M12, and from the NPort 5000AI-M12 to the host.

TCP Server Mode

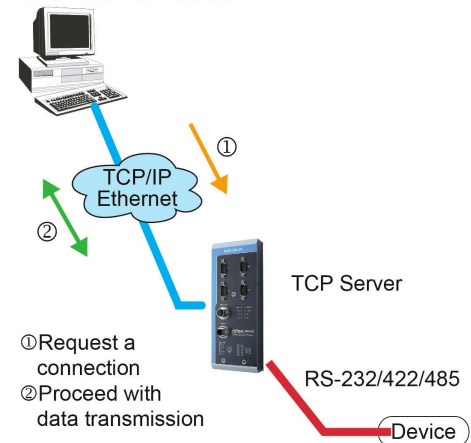

TCP Client Mode

In TCP Client mode, the NPort 5000AI-M12 can actively establish a TCP connection to a pre-defined host computer when serial data arrives.

After the data has been transferred, the NPort can automatically disconnect from the host computer by using the **TCP alive check time** or **Inactivity time** settings. Refer to chapter 5 for more details.

As illustrated in the figure, data transmission proceeds as follows:

1. The NPort 5000AI-M12 configured for TCP Client Mode requests a connection from the host.
2. Once the connection is established, data can be transmitted in both directions—from the host to the NPort 5000AI-M12, and from the NPort 5000AI-M12 to the host.

TCP Client Mode

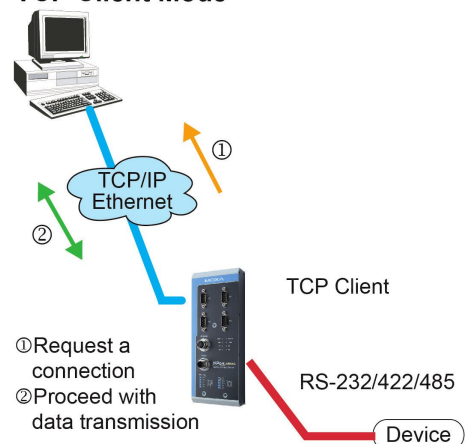

UDP Mode

Compared to TCP communication, UDP is faster and more efficient. In UDP mode, you can not only unicast but also multicast data from the serial device to multiple host computers, and the serial device can also receive data from multiple host computers, making this mode ideal for message display applications.

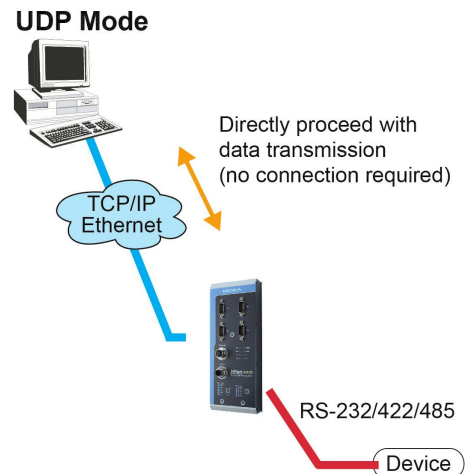

Pair Connection Mode

Pair Connection Mode employs two NPort 5000AI-M12 units in tandem, and can be used to remove the 15-meter distance limitation imposed by the RS-232 interface. One NPort 5000AI-M12 is connected from its RS-232 port to the COM port of a PC or other type of computer, such as a hand-held PDA, and the serial device is connected to the RS-232 port of the other NPort 5000AI-M12. The two NPort 5000AI-M12 units are then connected to each other with a cross-over Ethernet cable, both are connected to the same LAN, or in a more advanced setup, they communicate with each other over a WAN (i.e., through one or more routers). Pair Connection Mode transparently transfers both data and modem control signals (although it cannot transmit the DCD signal) between the two NPort device servers.

Ethernet Modem Mode

Ethernet Modem Mode is designed for use with legacy operating systems, such as MS-DOS, that do not support TCP/IP Ethernet. By connecting one of NPort 5000AI-M12's serial port to the MS-DOS computer's serial port, it is possible to use legacy software originally designed to transmit data via modem, but now transmit the data over the Ethernet.

Reverse Telnet Mode

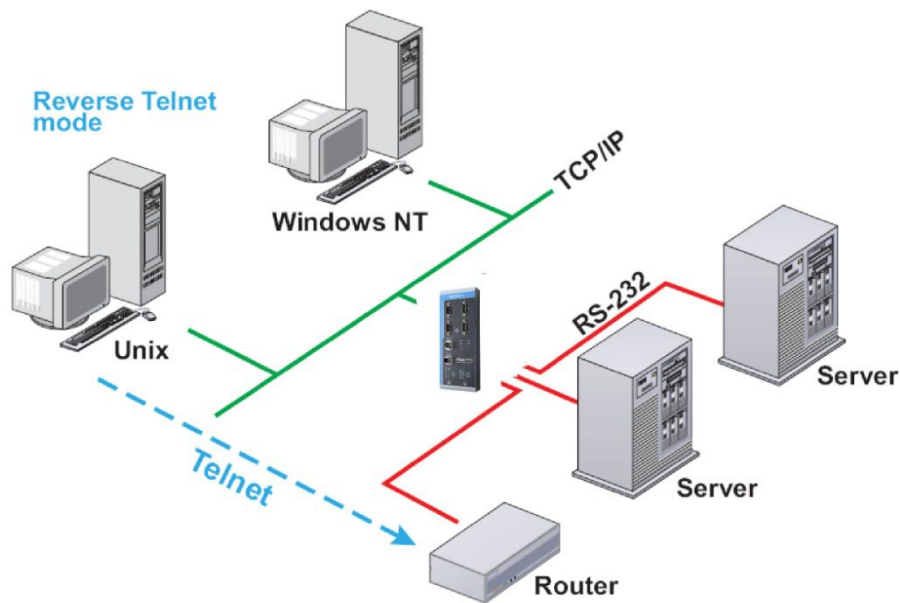

Console management is commonly used by connecting to Console/AUX or COM ports of routers, switches, and UPS units. Rtelnet works the same as RAW mode in that only one TCP port is listened to after booting up. The system then waits for a host on the network to initiate a connection. The difference is that the RAW mode does not provide the conversion function provided by Telnet. If the connected devices need to use the CR/LF conversion function when controlling, then users must choose Rtelnet mode.

Disabled Mode

When the Operation Mode for a particular port is set to **Disabled**, that port will be disabled.

Web Console Configuration

The Web Console is the most user-friendly of the methods available to configure the NPort 5000AI-M12. In this chapter, we introduce the Web Console function groups and function definitions.

The following topics are covered in this chapter:

- ❑ **Opening Your Browser**
- ❑ **Quick Setup**
- ❑ **Export/Import**
- ❑ **Basic Settings**
- ❑ **Network Settings**
- ❑ **LLDP Settings**
- ❑ **Serial Settings**
- ❑ **Operating Settings**
 - Real COM Mode
 - RFC2217 Mode
 - TCP Server Mode
 - TCP Client Mode
 - UDP Mode
 - Pair Connection Mode
 - Ethernet Modem Mode
 - Reverse Telnet Mode
 - Disabled Mode
- ❑ **Accessible IP Settings**
- ❑ **Auto Warning Settings**
 - Auto warning: Email and SNMP trap
 - Event Type
- ❑ **Upgrade Firmware**
- ❑ **Monitor**
 - Monitor Line
 - Monitor Async
 - Monitor Async-Settings
- ❑ **Change Password**
- ❑ **Load Factory Default**
- ❑ **Save/Restart**

Opening Your Browser

1. Make sure your browser has cookies enabled. To enable cookies in Internet Explorer, right click on the Internet Explorer icon on your desktop, select Properties, click on the Security tab, and then select Enable under Allow cookies that are stored on your computer, Allow per-session cookies (not stored), and File download.

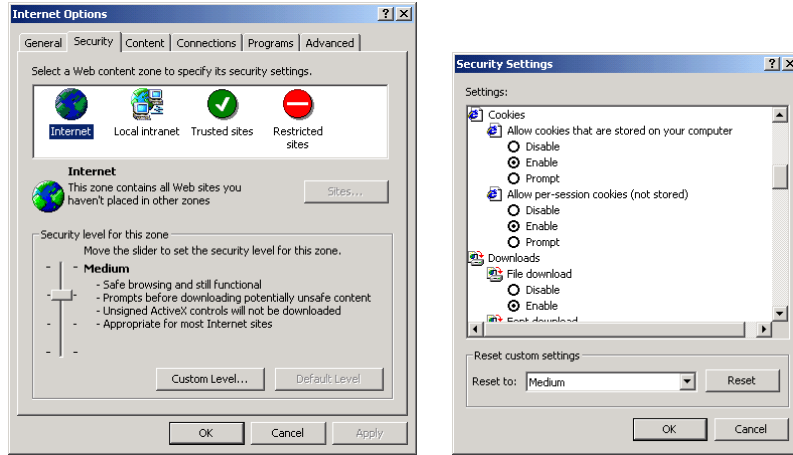

2. Enter the IP address of your device in the address field of the browser, then press the Enter key. The default IP address is **192.168.127.254**.
3. Input the password if prompted. The password will be transmitted with MD5 encryption over Ethernet. Note that you will not be prompted to enter the password if the NPort 5000AI-M12 is not currently password-protected.

MOXA® Total Solution for Industrial Device Networking www.moxa.com

| | | | | | |
|-------|------------------|------------|-------------------|-------------|----------------------|
| Model | - NPort IA5450AI | IP | - 192.168.127.254 | MAC Address | - 00:90:E8:12:34:57 |
| Name | - NP1A5450AI_2 | Serial NO. | - 2 | Firmware | - 1.0 Build 10032318 |

Password:

Login



ATTENTION

If you use other web browsers, remember to enable the functions to “allow cookies that are stored on your computer” or “allow per-session cookies.”
NPort 5000AI-M12 uses cookies only for password transmission.



ATTENTION

Refer to Chapter 3, **Initial IP Address Configuration**, to see how to configure the IP address. Examples shown in this chapter use the Factory Default IP address (192.168.127.254).

4. The NPort 5000AI-M12 homepage will open next. There are two buttons on this page: **Quick setup** and **Export/Import**. You can click **Overview** at any time to go back to this page. The following sections introduce these two convenient functions and all the other specific settings in the **Main Menu** on the left.



ATTENTION

If you can't remember the password, the **ONLY** way to configure the NPort 5000AI-M12 is to load factory defaults by using the "Reset to default" button located at the top side of NPort 5000AI-M12. Remember to export the configuration file when you have finished the configuration. After using the "Reset to default" button to load factory defaults, your configuration can be easily reloaded into the NPort 5000AI-M12 with the **Import** function.



ATTENTION

If your NPort 5000AI-M12 application requires using password protection, you must enable the cookie function in your browser. If the cookie function is disabled, you will not be allowed to enter the Web Console Screen.

Quick Setup

Quick Setup streamlines configuration of your NPort into three basic and quick steps that covers the most commonly-used settings. At any time while in Quick Setup you may click the **Back** button to return to the previous step, or the **Cancel** button to reverse all settings. For more detailed settings, please refer to the "Basic Settings," "Network Settings," "Serial Settings," and "Operating Settings," sections later in this chapter.

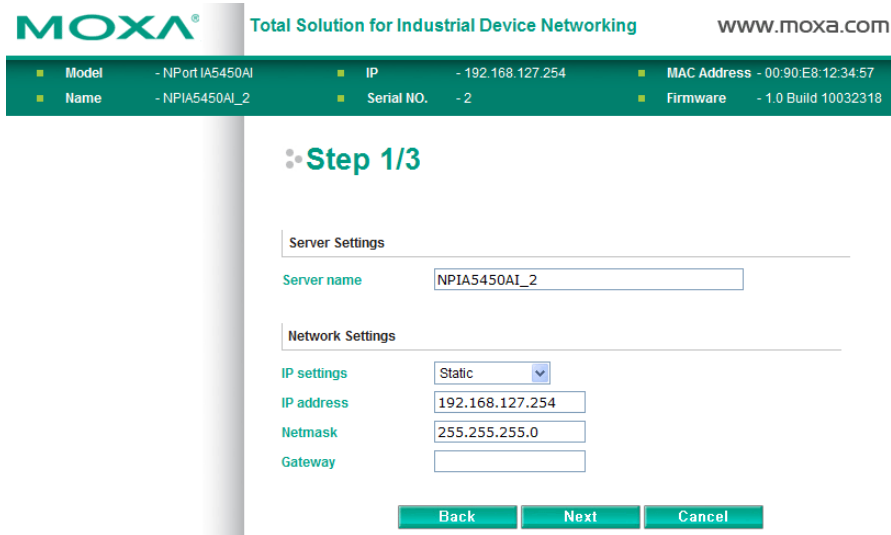

In Step 1/3, you must assign a valid IP address to the NPort 5000AI-M12 before it will work in your network environment. Your network system administrator should provide you with an IP address and related settings for your network. In addition, the server name field is a useful way to specify the location or application of different NPort 5000AI-M12s.

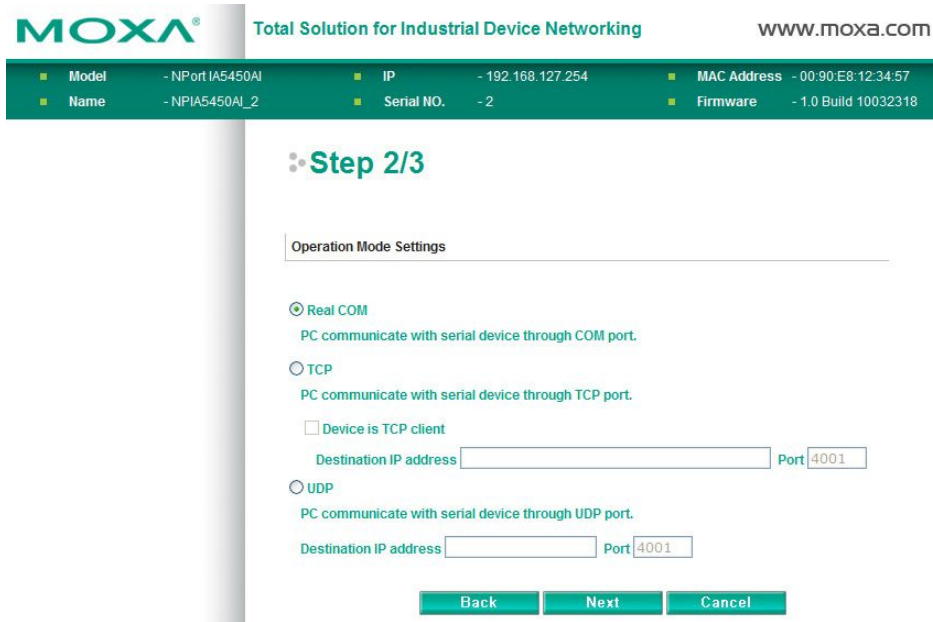

In the Step 2/3, you must specify which operation mode you will use. If your operation mode is not **Real COM**, **TCP Server**, **TCP Client** or **UDP mode**, please click **Cancel** and to go back to main menu and choose **Operating Settings** to select your proper setting.

MOXA Total Solution for Industrial Device Networking www.moxa.com

| | | | | | |
|-------|------------------|------------|-------------------|-------------|----------------------|
| Model | - NPort IA5450AI | IP | - 192.168.127.254 | MAC Address | - 00:90:E8:12:34:57 |
| Name | - NPIA5450AI_2 | Serial NO. | - 2 | Firmware | - 1.0 Build 10032318 |

Step 3/3

Serial Settings

Baud rate: 115200

Data bits: 8

Stop bits: 1

Parity: None

Interface: RS-232

Back Next Cancel

In the Step 3/3, you can modify the serial settings.

MOXA Total Solution for Industrial Device Networking www.moxa.com

| | | | | | |
|-------|------------------|------------|-------------------|-------------|----------------------|
| Model | - NPort IA5450AI | IP | - 192.168.127.254 | MAC Address | - 00:90:E8:12:34:57 |
| Name | - NPIA5450AI_2 | Serial NO. | - 2 | Firmware | - 1.0 Build 10032318 |

Finish Settings

Your changes have not been saved. Please check that your settings in the following and click Save/Restart for the updates to take effect or click Back to modify it.

Basic Settings

Server name: NPIA5450AI_2

Network Settings

IP settings: Static

IP: 192.168.127.254

Netmask: 255.255.255.0

Gateway:

Operation Mode Settings

Mode: RealCOM

Parameters: ---

Serial Settings

Baudrate: 115200

Parameters: Data bits: 8, Stop bits: 1, Parity: None

Interface: RS-232

Back Save/Restart Cancel

Review your settings at the **Finish Settings** page to confirm that they are correct, and then click the **Save/Restart** button to restart the device with the new settings.

MOXA Total Solution for Industrial Device Networking www.moxa.com

| | | | | | |
|-------|------------------|------------|-------------------|-------------|----------------------|
| Model | - NPort IA5450AI | IP | - 192.168.127.254 | MAC Address | - 00:90:E8:12:34:57 |
| Name | - NPIA5450AI_2 | Serial NO. | - 2 | Firmware | - 1.0 Build 10032318 |

Settings saved / Restarting...

Home

Note that if you changed the IP address, you will not be able to return to the Home Page with the **Home** button.

Export/Import

Export/Import allows you to back up and recover your settings.



Click **Export** to store all configuration data into a default file, **<Servername>.txt**. Click the **Import** button to upload a configuration file to the NPort 5000AI-M12.

Basic Settings

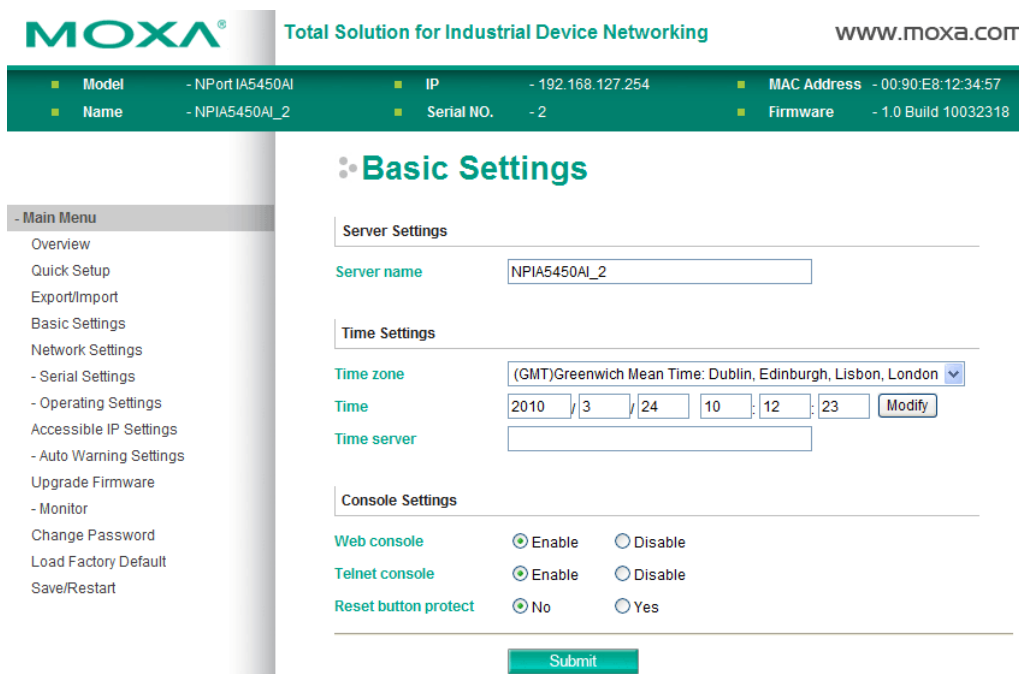

Server name

| Setting | Factory Default | Necessity |
|--------------------|-----------------------------|-----------|
| 1 to 39 characters | NP[model name]_[Serial No.] | Optional |

This option is useful for specifying the location or application of different NPort 5000AI-M12s.

Web/Telnet Console

The "Disable" option for "Web Console" and "Telnet Console" is included for security reasons. In some cases, you may want to disable one or both of these console utilities as an extra precaution to prevent unauthorized users from accessing your NPort 5000AI-M12. The factory default for both Web console and Telnet console is **Enable**.

Web console

| Setting | Factory Default | Necessity |
|-------------------|-----------------|-----------|
| Enable or Disable | Enable | Required |

Telnet console

| Setting | Factory Default | Necessity |
|-------------------|-----------------|-----------|
| Enable or Disable | Enable | Required |



ATTENTION

If you disable both the “Web console” and “Telnet console,” you can still use NPort Administrator to configure NPort 5000AI-M12 device servers locally or remotely over the network. Refer to Chapter 6 for more details.

Reset button protect

| Setting | Factory Default | Necessity |
|-----------|-----------------|-----------|
| No or Yes | None | Optional |

Network Settings

You must assign a valid IP address to the NPort 5000AI-M12 before it will work in your network environment. Your network system administrator should provide you with an IP address and related settings for your network. The IP address must be unique within the network (otherwise, the NPort 5000AI-M12 will not have a valid connection to the network). First time users can refer to Chapter 3, **Initial IP Address Configuration**, for more information.

You can choose from four possible **IP Configuration** modes—**Static**, **DHCP**, **DHCP/BOOTP**, and **BOOTP**—located under the web console screen’s IP configuration drop-down box.

IP configuration

| Method | Function Definition | Default |
|------------|--|---------|
| Static | User defined IP address, Netmask, Gateway. | |
| DHCP | DHCP Server assigned IP address, Netmask, Gateway, DNS, and Time Server | |
| DHCP/BOOTP | DHCP Server assigned IP address, Netmask, Gateway, DNS, and Time Server, or BOOTP Server assigned IP address (if the DHCP Server does not respond) | |
| BOOTP | BOOTP Server assigns IP address | |

IP address

| Setting | Factory Default | Necessity |
|---|-----------------|-----------|
| E.g., 192.168.1.1 (IP addresses of the form x.x.x.0 and x.x.x.255 are invalid.) | 192.168.127.254 | Required |

An IP address is a number assigned to a network device (such as a computer) as a permanent address on the network. Computers use the IP address to identify and talk to each other over the network. Choose a proper IP address which is unique and valid in your network environment.

Netmask

| Setting | Factory Default | Necessity |
|---------------------|-----------------|-----------|
| E.g., 255.255.255.0 | 255.255.255.0 | Required |

A subnet mask represents all of the network hosts at one geographic location, in one building, or on the same local area network. When a packet is sent out over the network, the NPort 5000AI-M12 will use the subnet mask to check whether the desired TCP/IP host specified in the packet is on the local network segment. If the address is on the same network segment as the NPort 5000AI-M12, a connection is established directly from the NPort 5000AI-M12. Otherwise, the connection is established through the given default gateway.

Gateway

| Setting | Factory Default | Necessity |
|-------------------|-----------------|-----------|
| E.g., 192.168.1.1 | None | Optional |

A gateway is a network gateway that acts as an entrance to another network. Usually, the computers that control traffic within the network or at the local Internet service provider are gateway nodes. NPort 5000AI-M12 needs to know the IP address of the default gateway computer in order to communicate with the hosts outside the local network environment. For correct gateway IP address information, consult the network administrator.

IP configuration

| Setting | Factory Default | Necessity |
|---------------------------------|-----------------|-----------|
| Static, DHCP, DHCP/BOOTP, BOOTP | Static | Required |

**ATTENTION**

In Dynamic IP environments, the firmware will retry 3 times every 30 seconds until network settings are assigned by the DHCP or BOOTP server. The Timeout for each try increases from 1 second, to 3 seconds, to 5 seconds. If the DHCP/BOOTP Server is unavailable, the firmware will use the default IP address (192.168.127.254), Netmask, and Gateway for IP settings.

DNS server 1 / DNS server 2

| Setting | Factory Default | Necessity |
|---|-----------------|-----------|
| (IP addresses of the form x.x.x.0 and x.x.x.255 are invalid.) | None | Optional |

When the user wants to visit a particular website, the computer asks a Domain Name System (DNS) server for the website's correct IP address, and then the computer uses the response to connect to the web server. DNS is the way that Internet domain names are identified and translated into IP addresses. A domain name is an alphanumeric name, such as moxa.com, that it is usually easier to remember. A DNS server is a host that translates this kind of text-based domain name into the numeric IP address used to establish a TCP/IP connection.

In order to use NPort 5000AI-M12's DNS feature, you need to configure the DNS server. Doing so allows NPort 5000AI-M12 to use a host's domain name to access the host. NPort 5000AI-M12 provides DNS server 1 and

DNS server 2 configuration items to configure the IP address of the DNS server. DNS Server 2 is included for use when DNS sever 1 is unavailable.

NPort 5000AI-M12 plays the role of DNS client, in the sense that the NPort 5000AI-M12 will actively query the DNS server for the IP address associated with a particular domain name. NPort 5000AI-M12 functions that support domain name are **Time server, Destination IP Address in TCP Client mode, Mail Server, SNMP trap server, and Auto report to IP.**

SNMP Settings

Community name

| Setting | Factory Default | Necessity |
|--------------------|-----------------|-----------|
| 1 to 39 characters | public | Optional |

A community name is a plain-text password mechanism that is used to weakly authenticate queries to agents of managed network devices.

Contact

| Setting | Factory Default | Necessity |
|---|-----------------|-----------|
| 1 to 39 characters (E.g., Support, 886-89191230 #300) | None | Optional |

The SNMP contact information usually includes an emergency contact name and telephone or pager number.

Location

| Setting | Factory Default | Necessity |
|---|-----------------|-----------|
| 1 to 39 characters (E.g., Floor 1, office 2) | None | Optional |

Specify the location string for SNMP agents such as the NPort 5000AI-M12. This string is usually set to the street address where the NPort 5000AI-M12 is physically located.

IP Address Report

When NPort 5000AI-M12 products are used in a dynamic IP environment, users must spend more time with IP management tasks. For example, if the NPort 5000AI-M12 works as a server (TCP or UDP), then the host, which acts as a client, must know the IP address of the server. If the DHCP server assigns a new IP address to the NPort 5000AI-M12, the host must have some way of determining the NPort 5000AI-M12's new IP address.

NPort 5000AI-M12 products help out by periodically reporting their IP address to the IP location server, in case the dynamic IP has changed. The parameters shown below are used to configure the Auto IP report function. There are two ways to develop an "Auto IP report Server" to receive the NPort 5000AI-M12's Auto IP report.

1. Use the NPort Administrator's IP Address Report function.
2. The Auto IP report protocol can automatically receive the Auto IP report on a regular basis, and is also available to help you develop your own software. Refer to Appendix E for the "Auto IP report protocol".

Auto report to IP

| Setting | Factory Default | Necessity |
|--|-----------------|-----------|
| E.g., 192.168.1.1 or URL (IP addresses of the form x.x.x.0 and x.x.x.255 are invalid.) | None | Optional |

Reports generated by the Auto report function will be automatically sent to this IP address.

Auto report to TCP port

| Setting | Factory Default | Necessity |
|------------|-----------------|-----------|
| E.g., 4001 | 4002 | Optional |

Auto report period

| Setting | Factory Default | Necessity |
|----------------------------|-----------------|-----------|
| Time interval (in seconds) | 10 | Optional |

LLDP Settings

LLDP Settings

LLDP Enable Disable

Message Transmit Interval (5~32768 secs)

This section is used to configure the setting of LLDP protocol, The LLDP (Link Layer Discovery Protocol) may be used as a component in network management and monitoring applications.

LLDP

| Setting | Factory Default | Necessity |
|-------------------|-----------------|-----------|
| Enable or Disable | Enable | Optional |

Message Transmit Interval

| Setting | Factory Default | Necessity |
|-----------------|-----------------|-----------|
| 5 to 32768 secs | 30 | Optional |

This parameter is used to adjust LLDP query period

Serial Settings

Click **Serial Settings**, located under **Main Menu**, to display serial port settings for port 1.

MOXA Total Solution for Industrial Device Networking www.moxa.com

Model - NPort IA5450AI
IP - 192.168.127.254
MAC Address - 00:90:E8:12:34:57
Name - NP1A5450AI_2
Serial NO. - 2
Firmware - 1.0 Build 10032318

Serial Settings

| Port | Alias | Baud rate | Data bits | Stop bits | Parity | FIFO | Flow ctrl | Interface |
|------|-------|-----------|-----------|-----------|--------|--------|-----------|-----------|
| 1 | | 115200 | 8 | 1 | None | Enable | RTS/CTS | RS-232 |
| 2 | | 115200 | 8 | 1 | None | Enable | RTS/CTS | RS-232 |
| 3 | | 115200 | 8 | 1 | None | Enable | RTS/CTS | RS-232 |
| 4 | | 115200 | 8 | 1 | None | Enable | RTS/CTS | RS-232 |

To modify serial settings for a particular port, click either **Port X (X=1 or 2 or 3 or 4)** under **Serial Settings**, located under **Main Menu** on the left side of the browser window.

Port alias

| Setting | Factory Default | Necessity |
|--|-----------------|-----------|
| 1 to 15 characters (E.g., PLC-No.1) | None | Optional |

“Port alias” is included to allow easy identification of the serial devices that are connected to the NPort 5000AI-M12’s serial ports.

Serial Parameters



ATTENTION

Check the serial communication parameters in your serial device’s user’s manual. You should set up the NPort 5000AI-M12’s serial parameters with the same communication parameters used by your serial devices.

Baudrate

| Setting | Factory Default | Necessity |
|----------------------|-----------------|-----------|
| 50 bps to 921.6 Kbps | 115.2 Kbps | Required |

Data bits

| Setting | Factory Default | Necessity |
|------------|-----------------|-----------|
| 5, 6, 7, 8 | 8 | Required |

When the user sets **Data bits** to 5 bits, the **Stop bits** setting will automatically change to 1.5 bits.

Stop bits

| Setting | Factory Default | Necessity |
|-----------|-----------------|-----------|
| 1, 1.5, 2 | 1 | Required |

Stop bits will be set to 1.5 when **Data bits** is set to 5 bits.

Parity

| Setting | Factory Default | Necessity |
|---------------------------------|-----------------|-----------|
| None, Even, Odd, Space, Mark | None | Required |

Flow control

| Setting | Factory Default | Necessity |
|----------------------------------|-----------------|-----------|
| None, RTS/CTS, DTR/DSR, Xon/Xoff | RTS/CTS | Required |

FIFO

| Setting | Factory Default | Necessity |
|-----------------|-----------------|-----------|
| Enable, Disable | Enable | Required |

The NPort 5000AI-M12’s serial ports provide a 16-byte FIFO in both the Tx and Rx directions. To prevent unexpected communication, disable the FIFO setting when your serial device does not have a FIFO.

Interface

| Setting | Factory Default | Necessity |
|----------------|-----------------|-----------|
| RS-232/422/485 | RS-232 | Required |

Operating Settings



Total Solution for Industrial Device Networking

www.moxa.com

| | | |
|--------------------------|------------------------|-----------------------------------|
| ■ Model - NPort IA5450AI | ■ IP - 192.168.127.254 | ■ MAC Address - 00:90:E8:12:34:57 |
| ■ Name - NPIA5450AI_2 | ■ Serial NO. - 2 | ■ Firmware - 1.0 Build 10032318 |

- Main Menu

- Overview
- Quick Setup
- Export/Import
- Basic Settings
- Network Settings
- Serial Settings
- Operating Settings
- Port 1
- Port 2
- Port 3
- Port 4
- Accessible IP Settings
- Auto Warning Settings
- Upgrade Firmware

Operation Modes

| Port | Operating Mode | Packing Length | Delimiter 1 | Delimiter 2 | Delimiter Process | Force Transmit |
|------|----------------|-------------------------|--------------|-------------------|-------------------|----------------|
| 1 | RealCOM | 0 | 00 (Disable) | 00 (Disable) | Do Nothing | 0 |
| | | TCP alive check time: 7 | | Max connection: 1 | | |
| 2 | RealCOM | 0 | 00 (Disable) | 00 (Disable) | Do Nothing | 0 |
| | | TCP alive check time: 7 | | Max connection: 1 | | |
| 3 | RealCOM | 0 | 00 (Disable) | 00 (Disable) | Do Nothing | 0 |
| | | TCP alive check time: 7 | | Max connection: 1 | | |
| 4 | RealCOM | 0 | 00 (Disable) | 00 (Disable) | Do Nothing | 0 |
| | | TCP alive check time: 7 | | Max connection: 1 | | |

Click **Operating Settings**, located under **Main Menu**, to display the operating settings for both of the NPort 5000AI-M12’s serial ports.

Real COM Mode

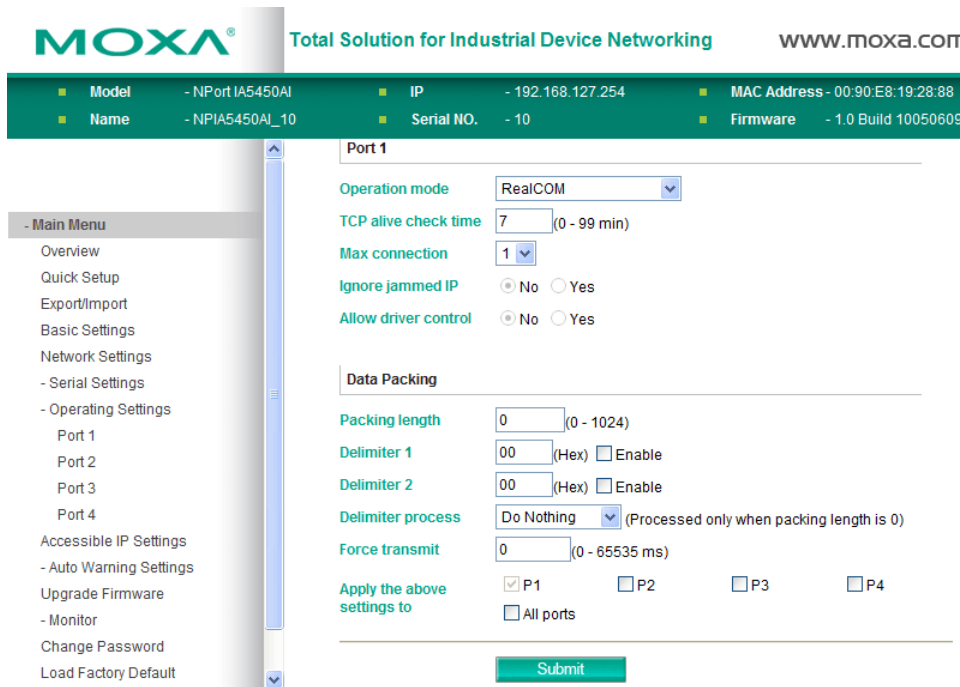

TCP alive check time

| Setting | Factory Default | Necessity |
|-------------|-----------------|-----------|
| 0 to 99 min | 7 min | Optional |

0 min: The TCP connection will not be closed due to an idle TCP connection.

1 to 99 min: NPort 5000AI-M12 automatically closes the TCP connection if there is no TCP activity for the given time. After the connection is closed, the NPort 5000AI-M12 starts listening for another Real COM driver connection from another host.

Max connection

| Setting | Factory Default | Necessity |
|------------------------|-----------------|-----------|
| 1, 2, 3, 4, 5, 6, 7, 8 | 1 | Required |

Max connection is usually used when the user needs to receive data from different hosts simultaneously. The factory default is 1. In this case, only one specific host can access this port of the NPort 5000AI-M12, and the Real COM driver on that host will have full control over the port.

Max Connection 1:

Allows only 1 host's Real COM driver to open the specific NPort 5000AI-M12 serial port.

Max Connection 2 to 8:

Allows 2 to 8 host's Real COM drivers to open the specific NPort 5000AI-M12 serial port, at the same time. When multiple hosts' Real COM drivers open the serial port at the same time, the COM driver only provides a pure data tunnel without control ability. That is, this serial port parameter will use the firmware's settings, not depend on your application program (AP).

Application software that is based on the COM driver will receive a driver response of "success" when the software uses any of the Win32 API functions. The firmware will only send the data back to the driver on the host.

Data will be sent first-in-first-out when data comes into the NPort 5000AI-M12 from the Ethernet interface.



ATTENTION

When “Max connection” is set greater than 1, this means that the NPort 5000AI-M12 will be using a “multi connection application” (i.e., Up to 8 hosts are allowed access to the port at the same time). When using a multi connection application, the NPort 5000AI-M12 will use the serial communication parameters set in the console. All of the hosts connected to that port must use the same serial settings. If one of the hosts opens the COM port with parameters that are different from the NPort 5000AI-M12’s console setting, data communication may not work properly.

Ignore jammed IP

| Setting | Factory Default | Necessity |
|-----------|-----------------|-----------|
| No or Yes | No | Optional |

By default, when **Max connection** is greater than 1, and the serial device is transmitting data, if any one of the connected hosts is not responding, it will wait until the data has been transmitted successfully before transmitting the second group of data to all hosts. If you select **Yes** under **Ignore jammed IP**, the host that is not responding will be ignored, but the data will still be transmitted to the other hosts.

Allow driver control

| Setting | Factory Default | Necessity |
|-----------|-----------------|-----------|
| No or Yes | No | Optional |

If **Max connection** is greater than 1, NPort will ignore driver control commands from all connected hosts. However, if you set **Allow driver control** to **Yes**, control commands will be accepted. Note that since the NPort 5000AI-M12 may get configuration changes from multiple hosts, the most recent command received will take precedence.

Packing length

| Setting | Factory Default | Necessity |
|-----------|-----------------|-----------|
| 0 to 1024 | 0 | Optional |

Default = 0, The Delimiter Process will be followed, regardless of the length of the data packet. If the data length (in bytes) matches the configured value, the data will be forced out. The data length can be configured for 0 to 1024 bytes. Set to 0 if you do not need to limit the length.

Delimiter 1

| Setting | Factory Default | Necessity |
|----------------|-----------------|-----------|
| 00 to FF (hex) | None | Optional |

Delimiter 2

| Setting | Factory Default | Necessity |
|----------------|-----------------|-----------|
| 00 to FF (hex) | None | Optional |

Once the NPort 5000AI-M12 receives both delimiters through its serial port, it immediately packs all data currently in its buffer and sends it to the NPort 5000AI-M12’s Ethernet port.



ATTENTION

Delimiter 2 is optional. If left blank, then Delimiter 1 alone trips clearing of the buffer. If the size of the serial data received is greater than 1 KB, the NPort 5000AI-M12 will automatically pack the data and send it to the Ethernet port. However, to use the delimiter function, you must at least enable Delimiter 1. If Delimiter 1 is left blank and Delimiter 2 is enabled, the delimiter function will not work properly.

Delimiter process

| Setting | Factory Default | Necessity |
|---|-----------------|-----------|
| Do nothing, Delimiter + 1, Delimiter + 2, Strip Delimiter | Do Nothing | Optional |

Delimiter + 1 or **Delimiter + 2**: The data will be transmitted when an additional byte (for **Delimiter +1**), or an additional 2 bytes (for **Delimiter +2**) of data is received after receiving the Delimiter.

Strip Delimiter: When the Delimiter is received, the Delimiter is deleted (i.e., stripped), and the remaining data is transmitted.

Do nothing: The data will be transmitted when the Delimiter is received.

Force transmit

| Setting | Factory Default | Necessity |
|---------------|-----------------|-----------|
| 0 to 65535 ms | 0 ms | Optional |

0: Disable the force transmit timeout.

1 to 65535: Forces the NPort 5000AI-M12's TCP/IP protocol software to try to pack serial data received during the specified time into the same data frame.

This parameter defines the time interval during which the NPort 5000AI-M12 fetches the serial data from its internal buffer. If data is incoming through the serial port, the NPort 5000AI-M12 stores the data in the internal buffer. The NPort 5000AI-M12 transmits data stored in the buffer via TCP/IP, but only if the internal buffer is full or if the Force transmit time interval reaches the time specified under **Force transmit**.

The optimal Force transmit timeout depends on your application, but it must be at least larger than one character interval within the specified baudrate. For example, assume that the serial port is set to 1200 bps, 8 data bits, 1 stop bit, and no parity. In this case, the total number of bits needed to send a character is 10 bits, and the time required to transfer one character is

$$(10 \text{ (bits)} / 1200 \text{ (bits/s)}) * 1000 \text{ (ms/s)} = 8.3 \text{ ms.}$$

Therefore, you should set Force transmit timeout to be larger than 8.3 ms, so in this case, it must be greater than or equal to 10 ms.

If the user wants to send a series of characters in the same packet, the serial device attached to the NPort 5000AI-M12 should send that series of characters during a time interval less than the Force transmit timeout for the NPort 5000AI-M12, and the total length of data must be less than or equal to the NPort 5000AI-M12's internal buffer size. The serial communication buffer size for the NPort 5000AI-M12 is 1 KB per port.

RFC2217 Mode

TCP alive check time

| Setting | Factory Default | Necessity |
|-------------|-----------------|-----------|
| 0 to 99 min | 7 min | Optional |

0 min: TCP connection is not closed due to an idle TCP connection.

1 to 99 min: The NPort 5000AI-M12 automatically closes the TCP connection if there is no TCP activity for the given time. After the connection is closed, the NPort 5000AI-M12 starts listening for another host's TCP connection.

Local TCP port

| Setting | Factory Default | Necessity |
|------------|-----------------|-----------|
| 1 to 65535 | 4001 | Required |

The **Local TCP port** is the TCP port that the NPort 5000AI-M12 uses to listen to connections, and that other devices must use to contact the NPort 5000AI-M12. To avoid conflicts with well known TCP ports, the default is set to 4001.

Packing length

| Setting | Factory Default | Necessity |
|-----------|-----------------|-----------|
| 0 to 1024 | 0 | Optional |

Default = 0: The Delimiter Process will be followed, regardless of the length of the data packet. If the data length (in bytes) matches the configured value, the data will be forced out. The data length can be configured for 0 to 1024 bytes. Set to 0 if you do not need to limit the length.

Delimiter 1

| Setting | Factory Default | Necessity |
|----------|-----------------|-----------|
| 00 to FF | None | Optional |

Delimiter 2

| Setting | Factory Default | Necessity |
|----------|-----------------|-----------|
| 00 to FF | None | Optional |

Once the NPort 5000AI-M12 receives both delimiters through its serial port, it immediately packs all data currently in its buffer and sends it out the NPort 5000AI-M12's Ethernet port.

Delimiter process

| Setting | Factory Default | Necessity |
|--|------------------------|------------------|
| Do Nothing, Delimiter + 1, Delimiter + 2, Strip Delimiter | Do Nothing | Optional |

Delimiter + 1 or Delimiter + 2: The data will be transmitted when an additional byte (for Delimiter +1), or an additional 2 bytes (for Delimiter +2) of data is received after receiving the Delimiter.

Strip Delimiter: When the Delimiter is received, the Delimiter is deleted (i.e., stripped), and the remaining data is transmitted.

Do Nothing: The data will be transmitted when the Delimiter is received.

Force transmit

| Setting | Factory Default | Necessity |
|----------------|------------------------|------------------|
| 0 to 65535 ms | 0 ms | Optional |

0: Disable the force transmit timeout.

1 to 65535: Forces the NPort 5000AI-M12's TCP/IP protocol software to try to pack serial data received during the specified time into the same data frame.

This parameter defines the time interval during which the NPort 5000AI-M12 fetches the serial data from its internal buffer. If data is incoming through the serial port, the NPort 5000AI-M12 stores the data in the internal buffer. The NPort 5000AI-M12 transmits data stored in the buffer via TCP/IP, but only if the internal buffer is full or if the Force transmit time interval reaches the time specified under Force transmit timeout.

The optimal Force transmit timeout depends on your application, but it must be at least larger than one character interval within the specified baudrate. For example, assume that the serial port is set to 1200 bps, 8 data bits, 1 stop bit, and no parity. In this case, the total number of bits needed to send a character is 10 bits, and the time required to transfer one character is

$$(10 \text{ (bits)} / 1200 \text{ (bits/s)}) * 1000 \text{ (ms/s)} = 8.3 \text{ ms.}$$

Therefore, you should set Force transmit timeout to a value larger than 8.3 ms, so in this case, it must be greater than or equal to 10 ms.

If the user wants to send a series of characters in the same packet, the serial device attached to the NPort 5000AI-M12 should send that series of characters during a time interval less than the Force transmit timeout for the NPort 5000AI-M12, and the total length of data must be less than or equal to the NPort 5000AI-M12's internal buffer size. The serial communication buffer size for the NPort 5000AI-M12 is 1 KB per port.

TCP Server Mode

TCP alive check time

| Setting | Factory Default | Necessity |
|-------------|-----------------|-----------|
| 0 to 99 min | 7 min | Optional |

0 min: The TCP connection will not be closed due to an idle TCP connection.

1 to 99 min: The NPort 5000AI-M12 automatically closes the TCP connection if there is no TCP activity for the given time. After the connection is closed, the NPort 5000AI-M12 starts listening for another host's TCP connection.

Inactivity time

| Setting | Factory Default | Necessity |
|---------------|-----------------|-----------|
| 0 to 65535 ms | 0 ms | Optional |

0 ms: TCP connection will not be closed due to an idle serial line.

1-65535 ms: The NPort 5000AI-M12 automatically closes the TCP connection if there is no serial data activity for the given time. After the connection is closed, the NPort 5000AI-M12 starts listening for another host's TCP connection.

This parameter defines the maintenance status as Closed or Listen for the TCP connection. The connection is closed if there is no incoming or outgoing data through the serial port during the specific Inactivity time.

If the Inactivity time is set to 0, the current TCP connection is kept active until a connection close request is received. Although Inactivity time is disabled, the NPort 5000AI-M12 will check the connection status between the NPort 5000AI-M12 and remote host by sending "keep alive" packets periodically. If the remote host does not respond to the packet, the NPort 5000AI-M12 assumes that the connection was closed down unintentionally. The NPort 5000AI-M12 will then force the existing TCP connection to close.

**ATTENTION**

The **Inactivity time** should be configured to be larger than the **Force transmit** timeout setting. To prevent the unintended loss of data due to the session disconnection, it is highly recommended that you set this value large enough so that the intended data transfer is completed.

Max connection

| Setting | Factory Default | Necessity |
|------------------------|-----------------|-----------|
| 1, 2, 3, 4, 5, 6, 7, 8 | 1 | Required |

Max connection is usually used when the user needs to receive data from different hosts simultaneously. The factory default only allows for 1 connection at a time.

Max connection 1: The NPort only allows 1 host to open the TCP connection to the specific serial port.

Max connection 2 to 8: Allows 2 to 8 host's TCP connection request to open this NPort 5000AI-M12 serial port, at the same time. When multiple hosts establish a TCP connection to the specific serial port at the same time, the NPort 5000AI-M12 will duplicate the serial data and transmit to all of the hosts. Ethernet data is sent on a first-in-first-out basis to the serial port when data comes into the NPort 5000AI-M12 from the Ethernet interface.

Ignore jammed IP

| Setting | Factory Default | Necessity |
|-----------|-----------------|-----------|
| No or Yes | No | Optional |

By default, when **Max connection** is greater than 1, and the serial device is transmitting data, if any one of the connected hosts is not responding, it will wait until the data has been transmitted successfully before transmitting the second group of data to all hosts. If you select **Yes** for **Ignore jammed IP**, the host that is not responding will be ignored, but the data will still be transmitted to the other hosts.

Allow driver control

| Setting | Factory Default | Necessity |
|-----------|-----------------|-----------|
| No or Yes | No | Optional |

If **Max connection** is greater than 1, the NPort will ignore driver control commands from all connected hosts. However, if you set **Allow driver control** to **Yes**, control commands will be accepted. Note that since the NPort 5000AI-M12 may get configuration changes from multiple hosts, the most recent command received will take precedence.

Packing length

| Setting | Factory Default | Necessity |
|-----------|-----------------|-----------|
| 0 to 1024 | 0 | Optional |

Default = 0, The Delimiter Process will be followed, regardless of the length of the data packet. If the data length (in bytes) matches the configured value, the data will be forced out. The data length can be configured for 0 to 1024 bytes. Set to 0 if you do not need to limit the length.

Delimiter 1

| Setting | Factory Default | Necessity |
|----------|-----------------|-----------|
| 00 to FF | None | Optional |

Delimiter 2

| Setting | Factory Default | Necessity |
|----------|-----------------|-----------|
| 00 to FF | None | Optional |

Once the NPort 5000AI-M12 receives both delimiters through its serial port, it immediately packs all data currently in its buffer and sends it out the NPort 5000AI-M12's Ethernet port.

**ATTENTION**

Delimiter 2 is optional. If left blank, then Delimiter 1 alone trips clearing of the buffer. If the size of the serial data received is greater than 1 KB, the NPort 5000AI-M12 will automatically pack the data and send it to the Ethernet. However, to use the delimiter function, you must at least enable Delimiter 1. If Delimiter 1 is left blank and Delimiter 2 is enabled, the delimiter function will not work properly.

Delimiter process

| Setting | Factory Default | Necessity |
|--|-----------------|-----------|
| Do Nothing, Delimiter + 1, Delimiter + 2, Strip Delimiter | Do Nothing | Optional |

Delimiter + 1 or Delimiter + 2: The data will be transmitted when an additional byte (for Delimiter +1), or an additional 2 bytes (for Delimiter +2) of data is received after receiving the Delimiter.

Strip Delimiter: When the Delimiter is received, the Delimiter is deleted (i.e., stripped), and the remaining data is transmitted.

Do Nothing: The data will be transmitted when the Delimiter is received.

Force transmit

| Setting | Factory Default | Necessity |
|---------------|-----------------|-----------|
| 0 to 65535 ms | 0 ms | Optional |

0: Disable the force transmit timeout.

1 to 65535: Forces the NPort 5000AI-M12's TCP/IP protocol software to try to pack serial data received during the specified time into the same data frame.

This parameter defines the time interval during which the NPort 5000AI-M12 fetches the serial data from its internal buffer. If data is incoming through the serial port, the NPort 5000AI-M12 stores the data in the internal buffer. The NPort 5000AI-M12 transmits data stored in the buffer via TCP/IP, but only if the internal buffer is full or if the Force transmit time interval reaches the time specified under Force transmit timeout.

The optimal Force transmit timeout depends on your application, but it must be at least larger than one character interval within the specified baudrate. For example, assume that the serial port is set to 1200 bps, 8 data bits, 1 stop bit, and no parity. In this case, the total number of bits needed to send a character is 10 bits, and the time required to transfer one character is

$$(10 \text{ (bits)} / 1200 \text{ (bits/s)}) * 1000 \text{ (ms/s)} = 8.3 \text{ ms.}$$

Therefore, you should set Force transmit timeout to be larger than 8.3 ms, so in this case, it must be greater than or equal to 10 ms.

If the user wants to send a series of characters in the same packet, the serial device attached to the NPort 5000AI-M12 should send that series of characters during a time interval less than the Force transmit timeout for the NPort 5000AI-M12, and the total length of data must be less than or equal to the NPort 5000AI-M12's internal buffer size. The serial communication buffer size for the NPort 5000AI-M12 is 1 KB per port.

Local TCP port

| Setting | Factory Default | Necessity |
|------------|-----------------|-----------|
| 1 to 65535 | 4001 | Required |

The **Local TCP port** is the TCP port that the NPort 5000AI-M12 uses to listen to connections, and that other devices must use to contact the NPort 5000AI-M12. To avoid conflicts with well known TCP ports, the default is set to 4001.

Command port

| Setting | Factory Default | Necessity |
|------------|-----------------|-----------|
| 1 to 65535 | 966 | Optional |

The **Command port** is a listen TCP port for IP-Serial Lib commands from the host. In order to prevent a TCP port conflict with other applications, the user can set the Command port to another port if needed. IP-Serial Lib will automatically check the Command Port on NPort 5000AI-M12 so that the user does not need to configure the program.

TCP Client Mode

The screenshot displays the MOXA web console interface. At the top, it shows the MOXA logo and the slogan "Total Solution for Industrial Device Networking" along with the website "www.moxa.com". Below this is a status bar with system information: Model (NPort IA5450AI), Name (NPIA5450AI_10), IP (192.168.127.253), Serial NO. (-10), MAC Address (00:90:E8:19:28:88), and Firmware (-1.0 Build 10050609).

The main content area is titled "Operation Modes" and is focused on "Port 1". The "Operation mode" is set to "TCP Client". The "TCP alive check time" is 7 (0-99 min), and the "Inactivity time" is 0 (0-65535 ms). The "Ignore jammed IP" option is set to "No". There are four "Destination IP address" fields, all set to 4001. "Designated local port" fields are set to 5011, 5012, 5013, and 5014. "Connection control" is set to "Startup/None".

The "Data Packing" section includes "Packing length" (0, 0-1024), "Delimiter 1" (00, Hex, Enable), "Delimiter 2" (00, Hex, Enable), "Delimiter process" (Do Nothing, Processed only when packing length is 0), and "Force transmit" (0, 0-65535 ms). At the bottom, there are checkboxes for "Apply the above settings to" P1, P2, P3, P4, and "All ports". A "Submit" button is located at the bottom right of the configuration area.

TCP alive check time

| Setting | Factory Default | Necessity |
|-------------|-----------------|-----------|
| 0 to 99 min | 7 min | Optional |

0 min: The TCP connection will not be closed due to an idle TCP connection.

1 to 99 min: The NPort 5000AI-M12 automatically closes the TCP connection if there is no TCP activity for the given time.

Inactivity time

| Setting | Factory Default | Necessity |
|---------------|-----------------|-----------|
| 0 to 65535 ms | 0 ms | Optional |

0 ms: The TCP connection will not be closed due to an idle serial line.

1-65535 ms: NPort 5000AI-M12 automatically closes the TCP connection if there is no serial data activity for the given time.

This parameter defines the maintenance status as Closed or Listen for the TCP connection. The connection is closed if there is no incoming or outgoing data through the serial port during the specific Inactivity time.

If the Inactivity time is set to 0, the current TCP connection is kept active until a connection close request is received. Although Inactivity time is disabled, the NPort 5000AI-M12 will check the connection status between the NPort 5000AI-M12 and remote host by sending "keep alive" packets periodically. If the remote host does not respond to the packet, the NPort 5000AI-M12 assumes that the connection was closed unintentionally. NPort 5000AI-M12 will then force the existing TCP connection to close.



ATTENTION

Inactivity time is ONLY active when **TCP connect on** is set to **Any character**.

Ignore jammed IP

| Setting | Factory Default | Necessity |
|-----------|-----------------|-----------|
| No or Yes | No | Optional |

By default, when **Max connection** is greater than 1, and the serial device is transmitting data, if any one of the connected hosts is not responding, it will wait until the data has been transmitted successfully before transmitting the second group of data to all hosts. If you select **Yes** for **Ignore jammed IP**, the host that is not responding will be ignored, but the data will still be transmitted to the other hosts.

Packing length

| Setting | Factory Default | Necessity |
|-----------|-----------------|-----------|
| 0 to 1024 | 0 | Optional |

Default = 0, The Delimiter Process will be followed, regardless of the length of the data packet. If the data length (in bytes) matches the configured value, the data will be forced out. The data length can be configured for 0 to 1024 bytes. Set to 0 if you do not need to limit the length.

Delimiter 1

| Setting | Factory Default | Necessity |
|----------------|-----------------|-----------|
| 00 to FF (hex) | None | Optional |

Delimiter 2

| Setting | Factory Default | Necessity |
|----------------|-----------------|-----------|
| 00 to FF (hex) | None | Optional |

Once the NPort 5000AI-M12 receives both delimiters through its serial port, it immediately packs all data currently in its buffer and sends it to the NPort 5000AI-M12's Ethernet port.



ATTENTION

Delimiter 2 is optional. If left blank, then Delimiter 1 alone trips clearing of the buffer. If the size of the serial data received is greater than 1 KB, the NPort 5000AI-M12 will automatically pack the data and send it to the Ethernet. However, to use the delimiter function, you must at least enable Delimiter 1. If Delimiter 1 is left blank and Delimiter 2 is enabled, the delimiter function will not work properly.

Delimiter process

| Setting | Factory Default | Necessity |
|--|-----------------|-----------|
| Do Nothing, Delimiter + 1, Delimiter + 2, Strip Delimiter | Do Nothing | Optional |

Delimiter + 1 or **Delimiter + 2**: The data will be transmitted when an additional byte (for Delimiter +1), or an additional 2 bytes (for Delimiter +2) of data is received after receiving the Delimiter.

Strip Delimiter: When the Delimiter is received, the Delimiter is deleted (i.e., stripped), and the remaining data is transmitted.

Do Nothing: The data will be transmitted when the Delimiter is received.

Force transmit

| Setting | Factory Default | Necessity |
|---------------|-----------------|-----------|
| 0 to 65535 ms | 0 ms | Optional |

0: Disable the force transmit timeout.

1 to 65535: Forces the NPort 5000AI-M12's TCP/IP protocol software to try to pack serial data received during the specified time into the same data frame.

This parameter defines the time interval during which the NPort 5000AI-M12 fetches the serial data from its internal buffer. If data is incoming through the serial port, the NPort 5000AI-M12 stores the data in the internal buffer. The NPort 5000AI-M12 transmits data stored in the buffer via TCP/IP, but only if the internal buffer is full or if the Force transmit time interval reaches the time specified under Force transmit timeout.

The optimal Force transmit timeout depends on your application, but it must be at least larger than one character interval within the specified baudrate. For example, assume that the serial port is set to 1200 bps, 8 data bits, 1 stop bit, and no parity. In this case, the total number of bits needed to send a character is 10 bits, and the time required to transfer one character is

$$(10 \text{ (bits)} / 1200 \text{ (bits/s)}) * 1000 \text{ (ms/s)} = 8.3 \text{ ms.}$$

Therefore, you should set Force transmit timeout to be larger than 8.3 ms, so in this case, it must be greater than or equal to 10 ms.

If the user wants to send a series of characters in the same packet, the serial device attached to the NPort 5000AI-M12 should send that series of characters during a time interval less than the Force transmit timeout for the NPort 5000AI-M12, and the total length of data must be less than or equal to the NPort 5000AI-M12's internal buffer size. The serial communication buffer size for the NPort 5000AI-M12 is 1 KB per port.

Destination IP address Function Name

| Setting | Description | Factory Default |
|---------|-------------|-----------------|
| Setting | Description | Default |

1/2/3/4

| Setting | Factory Default | Necessity |
|---|-----------------|-----------|
| IP address or Domain Name (E.g., 192.168.1.1) | None | Required |

Allows the NPort 5000AI-M12 to connect actively to the remote host whose IP address is set by this parameter.

**ATTENTION**

Up to 4 connections can be established between the NPort 5000AI-M12 and hosts. The connection speed or throughput may be low if one of the four connections is slow, since one slow connection will slow down the other connections.

**ATTENTION**

The **Destination IP address** parameter can use both IP address and Domain Name. For some applications, the user may need to send the data actively to the remote destination domain name.

Designated Local Port 1/2/3/4

| Setting | Factory Default | Necessity |
|--------------|--|-----------|
| TCP Port No. | 5011 (Port 1) 5012 (Port 2) 5013 (Port 3) 5014 (Port 4) | Required |

Connection control

| Setting | Factory Default | Necessity |
|--|-----------------|-----------|
| Startup/None, Any Character/None, Any Character/Inactivity Time, DSR ON/DSR OFF, DSR ON/None, DCD ON/DCD OFF, DCD ON/None | Startup/None | Required |

The meaning of each of the above settings is given in the table below. In general, both the Connect condition and Disconnect condition are given.

| Connect/Disconnect | Description |
|-----------------------------------|--|
| Startup/None (default) | A TCP connection will be established on startup, and will remain active indefinitely. |
| Any Character/None | A TCP connection will be established when any character is received from the serial interface, and will remain active indefinitely. |
| Any Character/ Inactivity Time | A TCP connection will be established when any character is received from the serial interface, and will be disconnected when the Inactivity time out is reached. |
| DSR On/DSR Off | A TCP connection will be established when a DSR "On" signal is received, and will be disconnected when a DSR "Off" signal is received. |
| DSR On/None | A TCP connection will be established when a DSR "On" signal is received, and will remain active indefinitely. |
| DCD On/DCD Off | A TCP connection will be established when a DCD "On" signal is received, and will be disconnected when a DCD "Off" signal is received. |
| DCD On/None | A TCP connection will be established when a DCD "On" signal is received, and will remain active indefinitely. |

UDP Mode

Packing length

| Setting | Factory Default | Necessity |
|-----------|-----------------|-----------|
| 0 to 1024 | 0 | Optional |

Default = 0, The Delimiter Process will be followed, regardless of the length of the data packet. If the data length (in bytes) matches the configured value, the data will be forced out. The data length can be configured for 0 to 1024 bytes. Set to 0 if you do not need to limit the length.

Delimiter 1

| Setting | Factory Default | Necessity |
|----------|-----------------|-----------|
| 00 to FF | None | Optional |

Delimiter 2

| Setting | Factory Default | Necessity |
|----------|-----------------|-----------|
| 00 to FF | None | Optional |

Once the NPort 5000AI-M12 receives both delimiters through its serial port, it immediately packs all data currently in its buffer and sends it out the NPort 5000AI-M12's Ethernet port.



ATTENTION

Delimiter 2 is optional. If left blank, then Delimiter 1 alone trips clearing of the buffer. If the size of the serial data received is greater than 1 KB, the NPort 5000AI-M12 will automatically pack the data and send it to the Ethernet. However, to use the delimiter function, you must at least enable Delimiter 1. If Delimiter 1 is left blank and Delimiter 2 is enabled, the delimiter function will not work properly.

Delimiter process

| Setting | Factory Default | Necessity |
|---|-----------------|-----------|
| Do Nothing, Delimiter + 1, Delimiter + 2, Strip Delimiter | Do Nothing | Optional |

Delimiter + 1 or Delimiter + 2: The data will be transmitted when an additional byte (for Delimiter +1), or an additional 2 bytes (for Delimiter +2) of data is received after receiving the Delimiter.

Strip Delimiter: When the Delimiter is received, the Delimiter is deleted (i.e., stripped), and the remaining data is transmitted.

Do Nothing: The data will be transmitted when the Delimiter is received.

Force transmit

| Setting | Factory Default | Necessity |
|---------------|-----------------|-----------|
| 0 to 65535 ms | 0 ms | Optional |

0: Disable the force transmit timeout.

1 to 65535: Forces the NPort 5000AI-M12’s TCP/IP protocol software to try to pack serial data received during the specified time into the same data frame.

This parameter defines the time interval during which the NPort 5000AI-M12 fetches the serial data from its internal buffer. If data is incoming through the serial port, the NPort 5000AI-M12 stores the data in the internal buffer. The NPort 5000AI-M12 transmits data stored in the buffer via TCP/IP, but only if the internal buffer is full or if the Force transmit time interval reaches the time specified under Force transmit timeout.

The optimal Force transmit timeout depends on your application, but it must be at least larger than one character interval within the specified baudrate. For example, assume that the serial port is set to 1200 bps, 8 data bits, 1 stop bit, and no parity. In this case, the total number of bits needed to send a character is 10 bits, and the time required to transfer one character is

$$(10 \text{ (bits)} / 1200 \text{ (bits/s)}) * 1000 \text{ (ms/s)} = 8.3 \text{ ms.}$$

Therefore, you should set Force transmit timeout to a value larger than 8.3 ms, so in this case, it must be greater than or equal to 10 ms.

If the user wants to send a series of characters in the same packet, the serial device attached to the NPort 5000AI-M12 should send that series of characters during a time interval less than the Force transmit timeout for the NPort 5000AI-M12, and the total length of data must be less than or equal to the NPort 5000AI-M12’s internal buffer size. The serial communication buffer size for the NPort 5000AI-M12 is 1 KB per port.

Destination IP address 1

| Setting | Factory Default | Necessity |
|---|-----------------|-----------|
| IP address range E.g., Begin: 192.168.1.1 End: 192.168.1.10 | Begin: Empty | Required |
| | End: Empty | |
| | Port: 4001 | |

Destination IP address 2/3/4

| Setting | Factory Default | Necessity |
|--|-----------------|-----------|
| IP address range E.g., Begin: 192.168.1.11 End: 192.168.1.20 | Begin: Empty | Optional |
| | End: Empty | |
| | Port: 4001 | |

Local listen port

| Setting | Factory Default | Necessity |
|------------|-----------------|-----------|
| 1 to 65535 | 4001 | Required |

To avoid conflicts with well known UDP ports, the UDP port that the NPort 5000AI-M12 listens to, and that other devices must use to contact the NPort 5000AI-M12, should be set to the default value of 4001.

UDP Multicast

A multicast packet is a packet sent by one host to multiple hosts. In multicast mode, hosts that belong to a specific multicast group will receive multicast packets sent to that group. When configuring a host as a multicast receiver over the Internet, routers on the host’s LAN must be informed. The Internet Group

Management Protocol (IGMP) is used to communicate group membership information between hosts and routers on a LAN. The NPort 5000AI-M12 supports IGMP version 2.

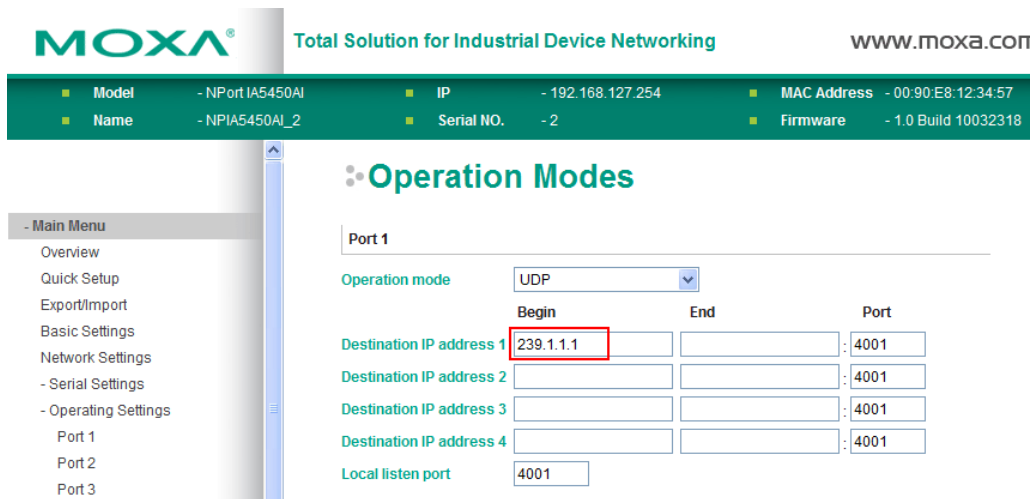

To add a network host to the multicast group, input the host’s IP address (e.g., 239.1.1.1) in one of the **Destination IP address** input boxes, as illustrated above. The NPort will automatically add this host to the multicast group, and the host will start receiving all packets sent by the NPort to this group.

Pair Connection Mode

Pair Connection Mode employs two NPort 5000AI-M12 device servers in tandem, and can be used to remove the 15-meter distance limitation imposed by the RS-232/422/485 interface. One NPort 5000AI-M12 is connected from its RS-232/422/485 port to the COM port of a PC or other type of computer, such as hand-held PDAs that have a serial port, and the serial device is connected to the RS-232/422/485 port of the other NPort 5000AI-M12. The two NPort 5000AI-M12 device servers are then connected to each other with a cross-over Ethernet cable, both are connected to the same LAN, or in a more advanced setup, they communicate with each other over a WAN (i.e., through one or more routers). Pair Connection Mode transparently transfers both data and modem control signals (although it cannot transmit the DCD signal) between the two NPorts.

Pair Connection Master Mode

When you select **Pair Connection Master Mode** for the Operation mode of one of the NPort 5000AI-M12 device servers this NPort 5000AI-M12 will be acting as a TCP client.

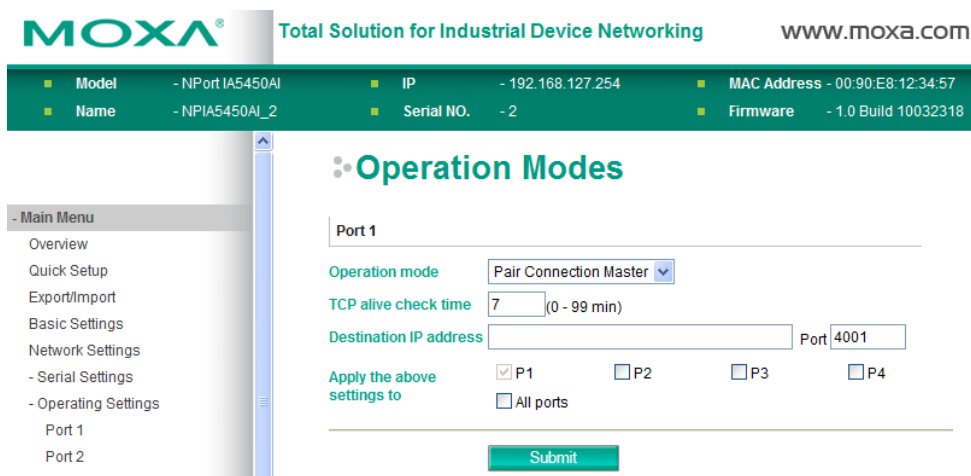

TCP alive check time

| Setting | Factory Default | Necessity |
|-------------|-----------------|-----------|
| 0 to 99 min | 7 min | Required |

0 min: TCP connection is not closed due to an idle TCP connection.

1 to 99 min: The NPort 5000AI-M12 closes the TCP connection automatically if there is no TCP activity for the given time.

Destination IP address

| Setting | Factory Default | Necessity |
|---|-----------------|-----------|
| IP address or Domain Name (E.g., 192.168.1.1) | blank | Optional |
| TCP port No. | 4001 | Required |

The Pair Connection "Master" will contact the network host that has this IP address. Data will be transmitted through the port No. (4001 by default). Note that you must configure the same TCP port No. for the device server acting as the Pair Connection "Slave."

Pair Connection Slave Mode

When you select **Pair Connection Slave Mode** for the Operation mode of one of the NPort 5000AI-M12 device servers this NPort 5000AI-M12 will be acting as a TCP server.

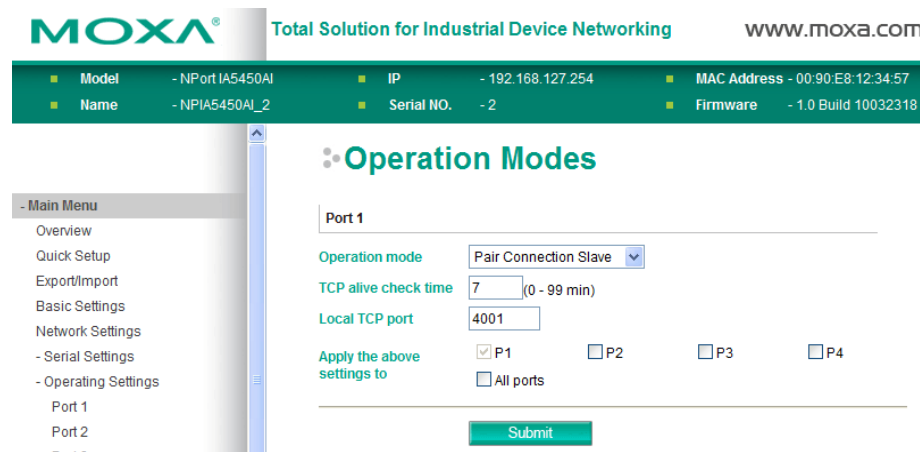

TCP alive check time

| Setting | Factory Default | Necessity |
|-------------|-----------------|-----------|
| 0 to 99 min | 7 min | Required |

0 min: TCP connection is not closed due to an idle TCP connection.

1 to 99 min: The NPort 5000AI-M12 closes the TCP connection automatically if there is no TCP activity for the given time.

Local TCP port

| Setting | Factory Default | Necessity |
|---------------------------|-----------------|-----------|
| TCP port No. (e.g., 4001) | 4001 | Required |

This Port No. must be the same port No. that you set up for the Pair Connection "Master" device server

Ethernet Modem Mode

MOXA Total Solution for Industrial Device Networking www.moxa.com

| | | | | | |
|-------|------------------|------------|-------------------|-------------|----------------------|
| Model | - NPort IA5450AI | IP | - 192.168.127.254 | MAC Address | - 00:90:E8:12:34:57 |
| Name | - NP1A5450AI_2 | Serial NO. | - 2 | Firmware | - 1.0 Build 10032318 |

Operation Modes

Port 1

Operation mode: Ethernet Modem

TCP alive check time: 7 (0 - 99 min)

Local TCP port: 4001

Apply the above settings to: P1 P2 P3 P4 All ports

Submit

Dial-in

The NPort 5000AI-M12 listens for a TCP/IP connection request from the remote Ethernet modem or host. The NPort 5000AI-M12's response depends on the ATSO value, as outlined below.

ATSO=0 (default):

The NPort 5000AI-M12 will temporarily accept the TCP connection and then send the "RING" signal out through the serial port. The serial controller must reply with "ATA" within 2.5 seconds to accept the connection request, after which the NPort 5000AI-M12 enters data mode. If no "ATA" command is received, the NPort 5000AI-M12 will disconnect after sending three "RING" signals.

ATSO≥1:

The NPort 5000AI-M12 will accept the TCP connection immediately and then send the "CONNECT <baud>" command to the serial port, in which <baud> represents the baudrate of the NPort 5000AI-M12's serial port. After that, the NPort 5000AI-M12 immediately enters data mode.

Dial-out

The NPort 5000AI-M12 accepts the AT command "ATD <IP>:<TCP port>" from the serial port and then requests a TCP connection from the remote Ethernet Modem or PC. This is where <IP> is the IP address of the remote Ethernet modem or PC, and <TCP port> is the TCP port number of the remote Ethernet modem or PC. Once the remote unit accepts this TCP connection, the NPort 5000AI-M12 will send out the "CONNECT <baud>" signal via the serial port and then enter data mode.

Disconnection request from local site

When the NPort 5000AI-M12s is in data mode, the user can drive the DTR signal to OFF, or send "+++ " from the local serial port to the NPort 5000AI-M12. The NPort 5000AI-M12 will enter command mode and return "NO CARRIER" via the serial port, and then input "ATH" to shut down the TCP connection after 1 second.

NOTE The "+++ " command cannot be divided. The "+" character can be changed in register S2, and the guard time, which prefixes and suffixes the "+++ " in order to protect the raw data, can be changed in register S12.

After the TCP connection has been shut down by the remote Ethernet modem or PC, the NPort 5000AI-M12 will send the "NO CARRIER" signal via the serial port and then return to command mode.

AT Commands

The NPort 5000AI-M12 supports the following common AT commands used with a typical modem:

| No. | AT command | Description | Remarks |
|-----|-----------------------|---|-------------------|
| 1 | ATA | Answer manually | |
| 2 | ATD <IP>:<Port> | Dial up the IP address: Port No. | |
| 3 | ATE | ATE0=Echo OFF ATE1=Echo ON (default) | |
| 4 | ATH | ATH0=On-hook (default) ATH1=Off-hook | |
| 5 | ATI, ATI0, ATI1, ATI2 | Modem version | reply "OK" only |
| 6 | ATL | Speaker volume option | reply "OK" only |
| 7 | ATM | Speaker control option | reply "OK" only |
| 8 | ATO | On line command | |
| 9 | ATP, ATT | Set Pulse/Tone Dialing mode | reply "OK" only |
| 10 | ATQ0, ATQ1 | Quiet command (default=ATQ0) | |
| 11 | ATSr=n | Change the contents of S register | See "S registers" |
| 12 | ATSr? | Read the contents of S register | See "S registers" |
| 13 | ATV | Result code type ATV0 for digit code ATV1 for text code 0=OK 1=connect (default) 2=ring 3=No carrier 4=error | |
| 14 | ATZ | Reset (disconnect, enter command mode and restore the flash settings) | |
| 15 | AT&C | Serial port DCD control AT&C0=DCD always on AT&C1=DTE detects connection by DCD on/off (default) | |
| 16 | AT&D | Serial port DTR control AT&D0=recognize DTE always ready AT&D1, AT&D2=reply DTE when DTR On (default) | |
| 17 | AT&F | Restore manufacturer's settings | |
| 18 | AT&G | Select guard time | reply "OK" only |
| 19 | AT&R | Serial port RTS option command | reply "OK" only |
| 20 | AT&S | Serial port DSR control | reply "OK" only |
| 21 | AT&V | View settings | |
| 22 | AT&W | Write current settings to flash for next boot up | |

S Registers

| No. | S Register | Description & default value | Remarks |
|-----|------------|--|-------------------|
| 1 | S0 | Ring to auto-answer (default=0) | |
| 2 | S1 | Ring counter (always=0) | no action applied |
| 3 | S2 | Escape code character (default=43 ASCII "+") | |
| 4 | S3 | Return character (default=13 ASCII) | |
| 5 | S4 | Line feed character (default=10 ASCII) | |
| 6 | S5 | Backspace character (default= 8 ASCII) | |
| 7 | S6 | Wait time for dial tone (always=2, unit=sec) | no action applied |
| 8 | S7 | Wait time for carrier (default=3, unit=sec) | |

| | | | |
|----|-----|---|-------------------|
| 9 | S8 | Pause time for dial delay (always=2, unit=sec) | no action applied |
| 10 | S9 | Carrier detect response time (always=6, unit 1/10 sec) | no action applied |
| 11 | S10 | Delay for hang up after carrier (always=14, unit 1/10 sec) | no action applied |
| 12 | S11 | DTMF duration and spacing (always=100 ms) | no action applied |
| 13 | S12 | Escape code guard time (default=50, unit 1/50 sec) to control the idle time for "+++" | |

TCP alive check time

| Setting | Factory Default | Necessity |
|-------------|-----------------|-----------|
| 0 to 99 min | 7 min | Required |

0 min: TCP connection is not closed due to an idle TCP connection.

1 to 99 min: The NPort 5000AI-M12 closes the TCP connection automatically if there is no TCP activity for the given time.

Local TCP port

| Setting | Factory Default | Necessity |
|------------|-----------------|-----------|
| 1 to 65535 | 4001 | Required |

The TCP port that other devices must use to contact this device. To avoid conflicts with standard TCP ports, the default is set to 4001.

Reverse Telnet Mode

The screenshot shows the MOXA web console interface. At the top, it says 'MOXA Total Solution for Industrial Device Networking' and 'www.moxa.com'. Below that is a status bar with device information: Model - NPort IA5450AI, IP - 192.168.127.254, MAC Address - 00:90:E8:12:34:57, Name - NPIA5450AI_2, Serial NO. - 2, Firmware - 1.0 Build 10032318. The main content area is titled 'Operation Modes' and shows settings for 'Port 1'. The 'Operation mode' is set to 'Reverse Telnet'. The 'TCP alive check time' is set to 7 (0 - 99 min). The 'Inactivity time' is set to 0 (0 - 65535 ms). The 'Local TCP port' is set to 4001. The 'Map <CR-LF>' is set to 'CR-LF'. There are checkboxes for 'Apply the above settings to' P1, P2, P3, P4, and 'All ports'. A 'Submit' button is at the bottom.

TCP alive check time

| Setting | Factory Default | Necessity |
|-------------|-----------------|-----------|
| 0 to 99 min | 7 min | Optional |

0 min: TCP connection is not closed due to an idle TCP connection.

1 to 99 min: The NPort 5000AI-M12 automatically closes the TCP connection if there is no TCP activity for the given time.

Inactivity time

| Setting | Factory Default | Necessity |
|---------------|-----------------|-----------|
| 0 to 65535 ms | 0 | Optional |

0 ms: TCP connection will not be closed due to an idle serial line.

1-65535 ms: The NPort 5000AI-M12 automatically closes the TCP connection if there is no serial data activity for the given time. After the connection is closed, the NPort 5000AI-M12 starts listening for another host’s TCP connection.

This parameter defines the maintenance status as Closed or Listen for the TCP connection. The connection is closed if there is no incoming or outgoing data through the serial port during the specific Inactivity time.

If the Inactivity time is set to 0, the current TCP connection is kept active until a connection close request is received. Although Inactivity time is disabled, the NPort 5000AI-M12 will check the connection status between the NPort 5000AI-M12 and remote host by sending “keep alive” packets periodically. If the remote host does not respond to the packet, the NPort 5000AI-M12 assumes that the connection was closed down unintentionally. The NPort 5000AI-M12 will then force the existing TCP connection to close.

Local TCP port

| Setting | Factory Default | Necessity |
|------------|-----------------|-----------|
| 1 to 65535 | 4001 | Required |

Each of the NPort 5000AI-M12’s serial ports is mapped to a TCP port. To avoid conflicts with common TCP port numbers, set port numbers to 4001 for port 1, 4002 for port 2, etc.

Map <CR-LF>

| Setting | Factory Default | Necessity |
|------------------|-----------------|-----------|
| CR, LF, or CR-LF | CR-LF | Required |

If data received through the NPort 5000AI-M12’s Ethernet port is sent using the “enter” command, the data will be transmitted out the serial port with an added

“carriage return + line feed” if you select the <CR-LF> option
(i.e., the cursor will jump to the next line, and return to the first character of the line)

“carriage return” if you select the <CR> option
(i.e., the cursor will return to the first character of the line)

“line feed” if you select the <LF> option.
(i.e., the cursor will jump to the next line, but not move horizontally)

Disabled Mode

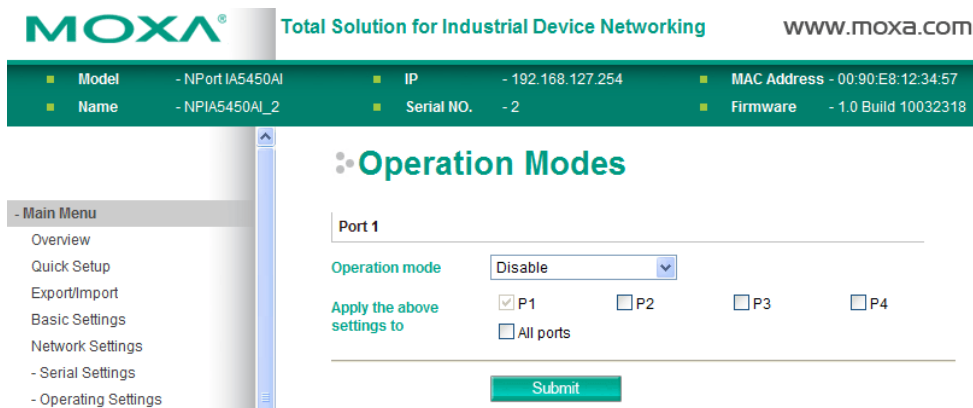

When Operation mode is set to Disabled, that particular port will be disabled. Check the “Apply the above settings to all serial ports” to apply this setting to the other port.

Accessible IP Settings

MOXA Total Solution for Industrial Device Networking www.moxa.com

Model - NPort IA5450AI
IP - 192.168.127.253
MAC Address - 00:90:E8:19:28:88
Name - NP1A5450AI_10
Serial NO. - 10
Firmware - 1.0 Build 10050609

Accessible IP List

Enable the accessible IP list (Not checking "Enable" will allow all IPs to connect.)

| No. | Activate the rule | IP Address | Netmask |
|-----|--------------------------|------------|---------|
| 1 | <input type="checkbox"/> | | |
| 2 | <input type="checkbox"/> | | |
| 3 | <input type="checkbox"/> | | |
| 4 | <input type="checkbox"/> | | |
| 5 | <input type="checkbox"/> | | |
| 6 | <input type="checkbox"/> | | |
| 7 | <input type="checkbox"/> | | |
| 8 | <input type="checkbox"/> | | |
| 9 | <input type="checkbox"/> | | |
| 10 | <input type="checkbox"/> | | |
| 11 | <input type="checkbox"/> | | |
| 12 | <input type="checkbox"/> | | |
| 13 | <input type="checkbox"/> | | |
| 14 | <input type="checkbox"/> | | |
| 15 | <input type="checkbox"/> | | |
| 16 | <input type="checkbox"/> | | |

The NPort 5000AI-M12 uses an IP address based filtering method to control access to itself.

Accessible IP Settings allows you to add or block remote host IP addresses to prevent unauthorized access. Access to the NPort 5000AI-M12 is controlled by IP address. That is, if a host's IP address is in the accessible IP table, then the host will be allowed to access the NPort 5000AI-M12. You can allow one of the following cases by setting the parameter.

Only one host with a specific IP address can access the NPort 5000AI-M12

Enter "IP address/255.255.255.255" (e.g., "192.168.1.1/255.255.255.255").

Hosts on a specific subnet can access the NPort 5000AI-M12

Enter "IP address/255.255.255.0" (e.g., "192.168.1.0/255.255.255.0").

Any host can access the NPort 5000AI-M12

Disable this function by un-checking the "Enable the accessible IP list" checkbox. Refer to the following table for more configuration examples.

| Allowable Hosts | Input format |
|--------------------------------|---------------------------------|
| Any host | Disable |
| 192.168.1.120 | 192.168.1.120 / 255.255.255.255 |
| 192.168.1.1 to 192.168.1.254 | 192.168.1.0 / 255.255.255.0 |
| 192.168.0.1 to 192.168.255.254 | 192.168.0.0 / 255.255.0.0 |
| 192.168.1.1 to 192.168.1.126 | 192.168.1.0 / 255.255.255.128 |
| 192.168.1.129 to 192.168.1.254 | 192.168.1.128 / 255.255.255.128 |

Auto Warning Settings

Auto warning: Email and SNMP trap

The screenshot shows the Moxa web console interface. At the top, the Moxa logo and tagline 'Total Solution for Industrial Device Networking' are visible, along with the website 'www.moxa.com'. Below this is a status bar showing device information: Model (NPort IA5450AI), IP (192.168.127.253), MAC Address (00:90:E8:19:28:88), Name (NPIA5450AI_10), Serial NO. (10), and Firmware (1.0 Build 10050609).

The main content area is titled 'E-mail and SNMP Trap Settings'. It is divided into two sections: 'Mail Server' and 'SNMP Trap Server'. The 'Mail Server' section includes a 'Mail server' text input field, a checkbox for 'My server requires authentication', and fields for 'User name' and 'Password'. Below these are four 'E-mail address' fields, with the first one containing the value 'NPIA5450AI_10@NPIA5450AI'. The 'SNMP Trap Server' section has a single text input field for 'SNMP trap server IP or domain name'. A green 'Submit' button is located at the bottom of the form.

Mail Server

Mail server

| Setting | Factory Default | Necessity |
|---------------------------|-----------------|-----------|
| IP Address or Domain Name | None | Optional |

User name

| Setting | Factory Default | Necessity |
|--------------------|-----------------|-----------|
| 1 to 15 characters | None | Optional |

Password

| Setting | Factory Default | Necessity |
|--------------------|-----------------|-----------|
| 1 to 15 characters | None | Optional |

From E-mail address

| Setting | Factory Default | Necessity |
|--------------------|-----------------|-----------|
| 1 to 63 characters | None | Optional |

E-mail address 1/2/3/4

| Setting | Factory Default | Necessity |
|--------------------|-----------------|-----------|
| 1 to 63 characters | None | Optional |



ATTENTION

Consult your Network Administrator or ISP for the proper mail server settings. The Auto warning function may not work properly if it is not configured correctly. the NPort 5000AI-M12 SMTP AUTH supports LOGIN, PLAIN, CRAM-MD5 (RFC 2554).

SNMP Trap Server

SNMP trap server IP or domain name

| Setting | Factory Default | Necessity |
|---------------------------|-----------------|-----------|
| IP address or Domain Name | None | Optional |

Event Type

The screenshot shows the Moxa web console interface. At the top, it displays the Moxa logo and the text 'Total Solution for Industrial Device Networking' and 'www.moxa.com'. Below this is a status bar with the following information:

- Model: - NPort 5450AI-M12
- IP: - 192.168.127.254
- MAC Address: - 00:90:E8:00:00:12
- Name: - NP5450AI-M12_12345
- Serial NO.: - 12345
- Firmware: - 1.0 Build 12072410

The main content area is titled 'Event Settings' and contains several sections with checkboxes for 'Mail' and 'Trap' notifications:

- System Event**
 - Cold start: Mail Trap
 - Warm start: Mail Trap
- Config Event**
 - Authentication failure: Mail Trap
 - IP changed: Mail
 - Password changed: Mail
- DCD Changed**
 - Port 1: Mail Trap
 - Port 2: Mail Trap
 - Port 3: Mail Trap
 - Port 4: Mail Trap
- DSR Changed**
 - Port 1: Mail Trap
 - Port 2: Mail Trap
 - Port 3: Mail Trap
 - Port 4: Mail Trap

A 'Submit' button is located at the bottom of the configuration area.

Cold start

This refers to starting the system from power off (contrast this with warm start). When performing a cold start, the NPort 5000AI-M12 will automatically issue an Auto warning message by e-mail, or send an SNMP trap after booting up.

Warm start

This refers to restarting the computer without turning the power off. When performing a warm start, the NPort 5000AI-M12 will automatically send an e-mail, or send an SNMP trap after rebooting.

Authentication failure

The user inputs a wrong password from the Console or Administrator. When authentication failure occurs, the NPort will immediately send an e-mail or send an SNMP trap.

IP address changed

The user has changed the NPort 5000AI-M12's IP address. When the IP address changes, the NPort 5000AI-M12 will send an e-mail with the new IP address before the NPort 5000AI-M12 reboots. If the NPort 5000AI-M12 is unable to send an e-mail message to the mail server within 15 seconds, the NPort 5000AI-M12 will reboot anyway, and abort the e-mail auto warning.

Password changed

The user has changed the NPort 5000AI-M12's password. When the password changes, the NPort 5000AI-M12 will send an e-mail with the password changed notice before the NPort 5000AI-M12 reboots. If the NPort 5000AI-M12 is unable to send an e-mail message to the mail server within 15 seconds, the NPort 5000AI-M12 will reboot anyway, and abort the e-mail auto warning.

DCD changed

The DCD (Data Carrier Detect) signal has changed, also indicating that the modem connection status has changed. For example, a DCD change to high also means "Connected" between local modem and remote modem. If the DCD signal changes to low, it also means that the connection line is down.

When the DCD changes, the NPort 5000AI-M12 will immediately send an e-mail or SNMP trap.

DSR changed

The DSR (Data Set Ready) signal has changed, also indicating that the data communication equipment's power is off. For example, a DSR change to high also means that the DCE is powered ON. If the DSR signal changes to low, it also means that the DCE is powered off.

When the DSR changes, the NPort 5000AI-M12 will immediately send an e-mail or SNMP trap.

Mail

| Setting | Factory Default | Necessity |
|-----------------|-----------------|-----------|
| Enable, Disable | Disable | Optional |

This feature helps the administrator manage how the NPort 5000AI-M12 sends e-mail to pre-defined e-mail boxes when the enabled events—such as Cold start, Warm start, Authentication failure, etc.—occur. To configure this feature, click the Event Type Mail checkbox.

Trap

| Setting | Factory Default | Necessity |
|-----------------|-----------------|-----------|
| Enable, Disable | Disable | Optional |

This feature helps the administrator manage how the NPort 5000AI-M12 sends SNMP Trap to a pre-defined SNMP Trap server when the enabled events—such as Cold start, Warm start, Authentication failure, etc.—occur. To configure this feature, click the Event Type Trap checkbox.

Upgrade Firmware

Keep your NPort 5000AI-M12 up to date with the latest firmware from Moxa. Occasionally, compare your NPort firmware to the version currently available at the Moxa website (www.moxa.com). If there is a new firmware version, you can download it and click Import to upgrade your firmware.

Monitor

Monitor Line

Click **Line** under **Monitor** to show the operation mode and status of each TCP/IP connection (IPx) for the serial ports.

| Port | Operation Mode | Connections |
|------|----------------|----------------------|
| 1 | RealCOM | [Listen] [] [] [] |
| | | [] [] [] [] |
| 2 | RealCOM | [Listen] [] [] [] |
| | | [] [] [] [] |
| 3 | RealCOM | [Listen] [] [] [] |
| | | [] [] [] [] |
| 4 | RealCOM | [Listen] [] [] [] |
| | | [] [] [] [] |

Monitor Async

Click **Async** under **Monitor** to show the current status of the serial port.

Total Solution for Industrial Device Networking
www.moxa.com

| | | | | | |
|---------|--------------------|--------------|-----------------|---------------|----------------------|
| ■ Model | - NPort 5450AI-M12 | ■ IP | - 192.168.33.16 | ■ MAC Address | - 00:90:E8:00:05:01 |
| ■ Name | - NP5450AI-M12_501 | ■ Serial NO. | - 501 | ■ Firmware | - 1.0 Build 12070614 |

Monitor Async

| Port | TxCnt | RxCnt | TxTotalCnt | RxTotalCnt | DSR | DTR | RTS | CTS | DCD |
|------|-------|-------|------------|------------|-----------------------|-----------------------|----------------------------------|-----------------------|-----------------------|
| 1 | 0 | 0 | 0 | 0 | <input type="radio"/> | <input type="radio"/> | <input checked="" type="radio"/> | <input type="radio"/> | <input type="radio"/> |
| 2 | 0 | 0 | 0 | 0 | <input type="radio"/> | <input type="radio"/> | <input checked="" type="radio"/> | <input type="radio"/> | <input type="radio"/> |
| 3 | 0 | 0 | 0 | 0 | <input type="radio"/> | <input type="radio"/> | <input checked="" type="radio"/> | <input type="radio"/> | <input type="radio"/> |
| 4 | 0 | 0 | 0 | 0 | <input type="radio"/> | <input type="radio"/> | <input checked="" type="radio"/> | <input type="radio"/> | <input type="radio"/> |

Main Menu

- Overview
- Quick Setup
- Export/Import
- Basic Settings
- Network Settings
- Serial Settings
- Operating Settings
- Accessible IP Settings
- Auto Warning Settings
- Upgrade Firmware
- Monitor
- Line
- Async
- Async-Settings

Monitor Async-Settings

Click **Async Setting** under **Monitor** to show the run-time settings for the serial port.

Total Solution for Industrial Device Networking
www.moxa.com

| | | | | | |
|---------|--------------------|--------------|-----------------|---------------|----------------------|
| ■ Model | - NPort 5450AI-M12 | ■ IP | - 192.168.33.16 | ■ MAC Address | - 00:90:E8:00:05:01 |
| ■ Name | - NP5450AI-M12_501 | ■ Serial NO. | - 501 | ■ Firmware | - 1.0 Build 12070614 |

Monitor Async-Settings

| Port | Baud Rate | Data Bits | Stop Bits | Parity | Flow Control | | | FIFO | Interface |
|------|-----------|-----------|-----------|--------|--------------|----------|---------|--------|-----------|
| | | | | | RTS/CTS | XON/XOFF | DTR/DSR | | |
| 1 | 115200 | 8 | 1 | None | OFF | OFF | OFF | Enable | RS-232 |
| 2 | 115200 | 8 | 1 | None | ON | OFF | OFF | Enable | RS-232 |
| 3 | 115200 | 8 | 1 | None | ON | OFF | OFF | Enable | RS-232 |
| 4 | 115200 | 8 | 1 | None | ON | OFF | OFF | Enable | RS-232 |

Main Menu

- Overview
- Quick Setup
- Export/Import
- Basic Settings
- Network Settings
- Serial Settings
- Operating Settings
- Accessible IP Settings
- Auto Warning Settings
- Upgrade Firmware
- Monitor
- Line
- Async
- Async-Settings

Change Password

Input the "Old password" and "New password" to change the password. Leave the password boxes blank to erase the password. If the password is erased, then the NPort 5000AI-M12 will not have password protection.



ATTENTION

If you forget the password, the ONLY way to configure the NPort 5000AI-M12 is by using the "Reset to default" button on the NPort 5000AI-M12's top side to "Load Factory Default."

Remember to export the configuration file when you finish the configuration. By using the Import function your configuration can be re-loaded into the NPort 5000AI-M12 after using "Load Factory Default."

Load Factory Default

This function will reset all of the NPort 5000AI-M12's settings to the factory default values. Be aware that previous settings will be lost.

Save/Restart

Click **Save/Restart** will save the current configured settings and restart the NPort 5000AI-M12 to take effect.

The screenshot shows the MOXA web console interface. At the top, the MOXA logo is on the left, followed by the tagline "Total Solution for Industrial Device Networking" and the website "www.moxa.com". Below this is a green header bar containing system information in a table:

| | | | | | |
|-------|------------------|------------|-------------------|-------------|----------------------|
| Model | - NPort IA5450AI | IP | - 192.168.127.254 | MAC Address | - 00:90:E8:12:34:57 |
| Name | - NPIA5450AI_2 | Serial NO. | - 2 | Firmware | - 1.0 Build 10032318 |

On the left side, there is a vertical "Main Menu" with the following items: Overview, Quick Setup, Export/Import, Basic Settings, Network Settings, - Serial Settings, - Operating Settings, Accessible IP Settings, - Auto Warning Settings, Upgrade Firmware, - Monitor, Change Password, Load Factory Default, and Save/Restart.

The main content area is titled "Save/Restart" with a sub-header icon. Below the title, it states: "The configuration has been changed. Please click to reboot with new configuration." A warning message follows: "Warning!! Reboot will disconnect both serial and Ethernet connections and data maybe lost." At the bottom of this section is a green "Submit" button.

Configuring NPort Administrator

The following topics are covered in this chapter:

- ❑ **Overview**
- ❑ **Installing NPort Administrator**
- ❑ **Configuration**
 - Broadcast Search
 - Unlock Password Protection
 - Configuring the NPort 5000AI-M12
 - Upgrading the Firmware
 - Export Configuration
 - Import Configuration
- ❑ **Monitor**
- ❑ **Port Monitor**
- ❑ **COM Mapping**
 - On-line COM Mapping
 - Off-line COM Mapping
- ❑ **COM Grouping**
- ❑ **IP Address Report**

Overview

NPort Administrator lets you install and configure your NPort 5000AI-M12 Series products easily over the network. Five function groups are provided to ease the installation process, allow off-line COM mapping, and provide monitoring and IP location server functions.

NPort Administrator is an integrated software suite that bundles NPort Administrator and the IP Serial Library, and provides everything you need to manage, monitor, and modify your NPort 5000AI-M12 from a remote location.

In this chapter, all the figures are captured by the NPort 5000AI-M12 Series for demonstration.

The operation is the same as NPort IA5000AI, the following steps use the NPort IA5450AI as the example.

Note: The NPort 5000AI-M12 will be supported starting from NPort Administration Suite v1.18.

Installing NPort Administrator

1. Once the Setup program starts running, click **Next** when the **Welcome** window opens to proceed with the installation.

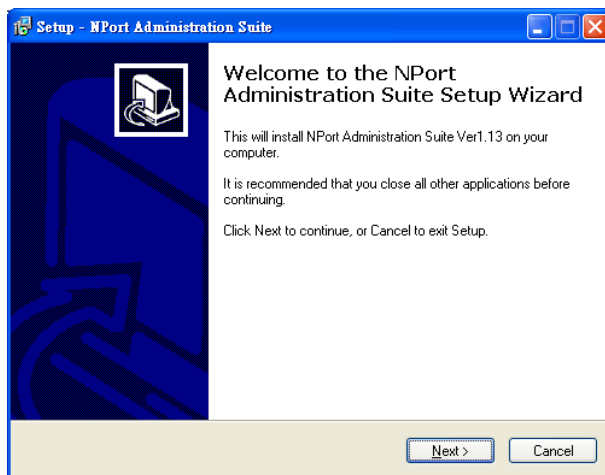

2. Click **Next** to install program files in the default directory, or select an alternative location.

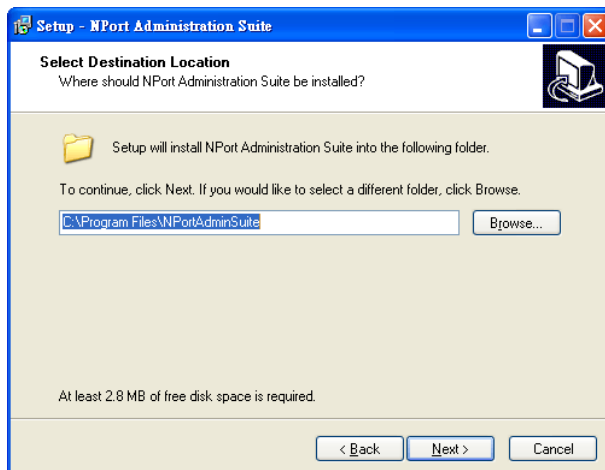

- Click **Next** to install the program using the default program name, or select a different name.

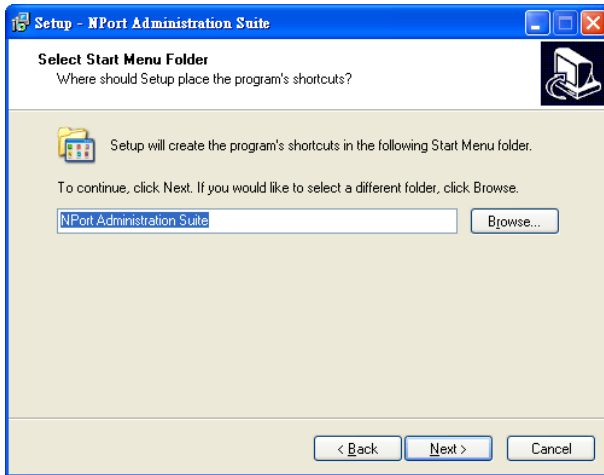

- Click **Install** to proceed with the installation.

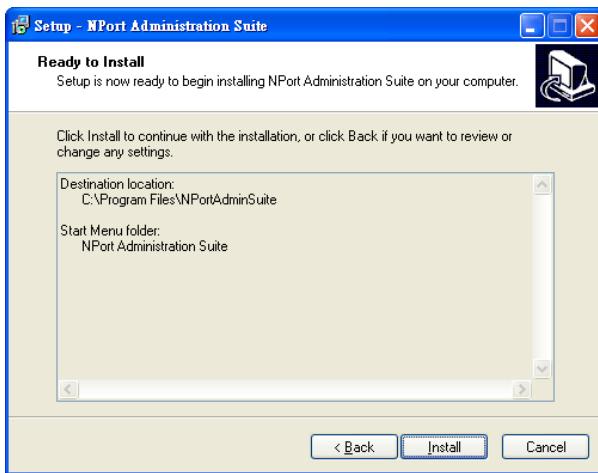

- The **Installing** window reports the progress of the installation.

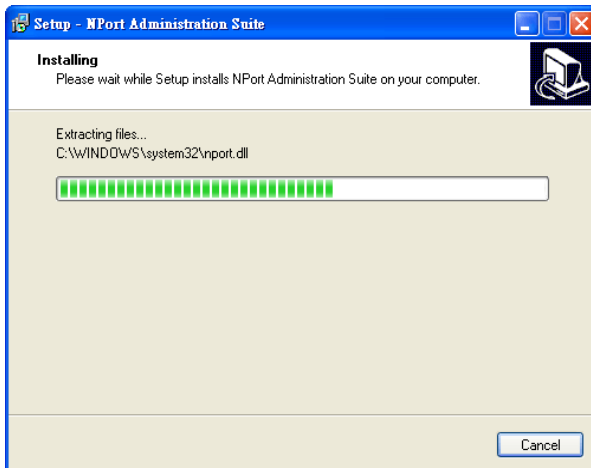

6. Click **Next** to proceed with the installation.

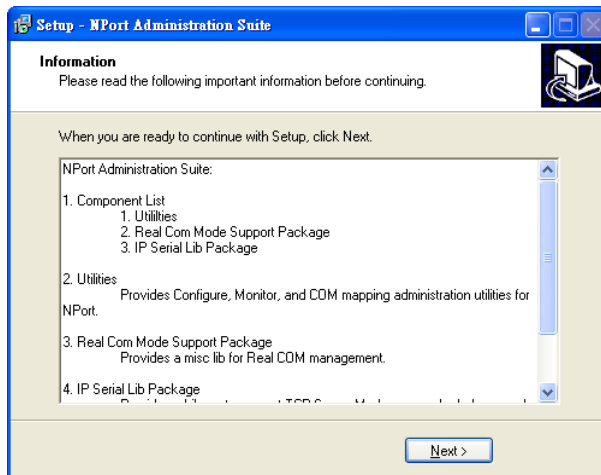

7. Click **Finish** to complete the installation of NPort Administration Suite.

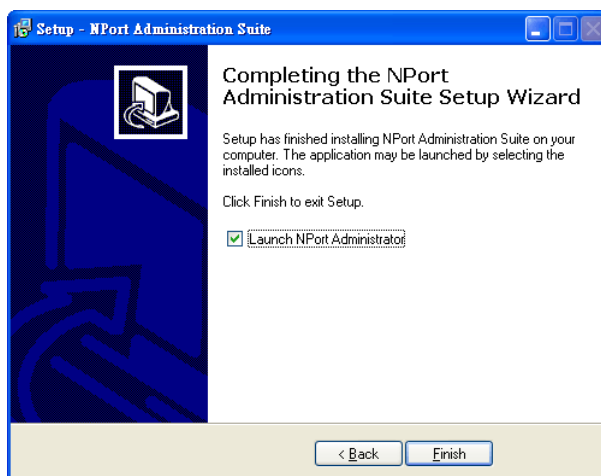

Configuration

The Administrator-Configuration window is divided into four parts.

- The top section contains the function list and online help area. (Windows NT does not support this .chm file format.)
- The five Administrator function groups are listed in the left section.
- A list of NPort 5000AI-M12 serial device servers, each of which can be selected to process user requirements, is displayed in the right section.
- The activity Log, which displays messages that record the user's processing history, is shown in the bottom section.

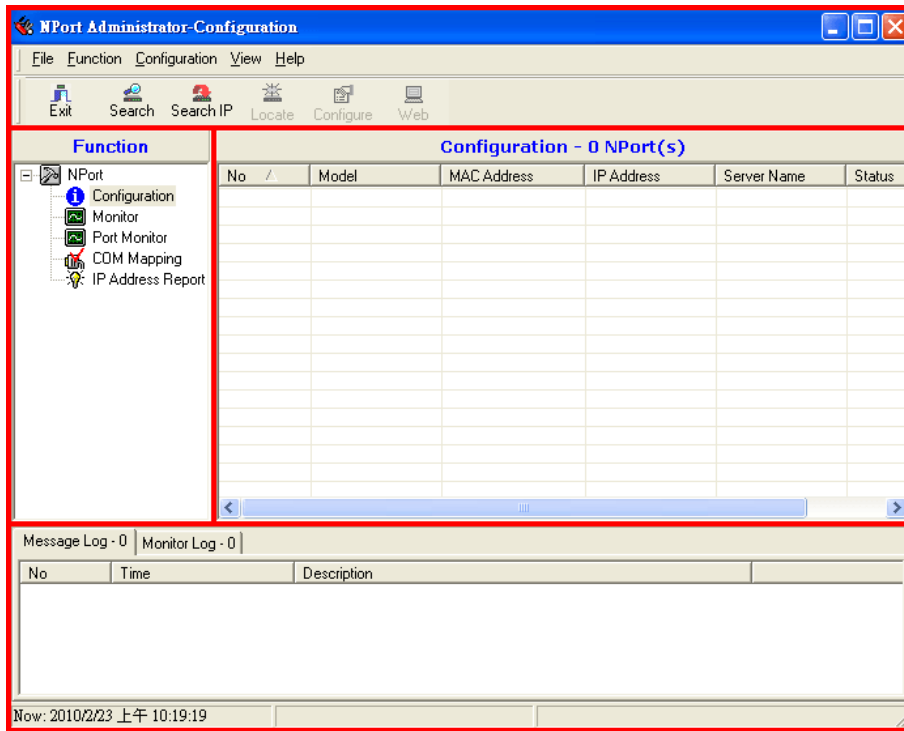

Broadcast Search

The **Broadcast Search** function is used to locate all NPort 5000AI-M12s that are connected to the same LAN as your computer. Since the Broadcast Search function searches by MAC address and not IP address, all NPort 5000AI-M12s connected to the LAN will be located, regardless of whether or not they are part of the same subnet as the host.

1. Position the cursor in the right middle section of the Administrator window and then click the right mouse button.

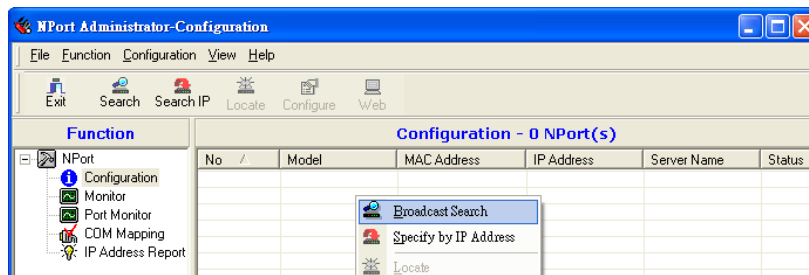

2. The **Broadcast Search** window will open and display the Model, IP Address, MAC Address, and Progress of the search for that particular device.

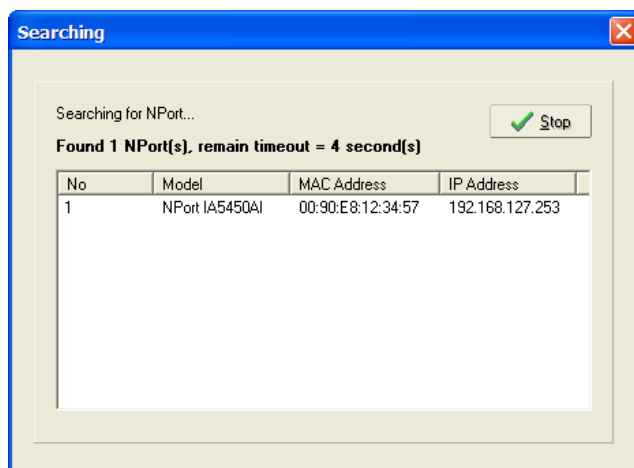

- When the search is complete, the Broadcast Search window will close, and the NPort 5000AI-M12s that were located will be displayed in the right pane of the Administrator window. If you found more than one server connected to this network, refer to the MAC address sticker on your server(s) to determine which server(s) are the ones you wish to configure. To configure an NPort 5000AI-M12, place the cursor over the row displaying that NPort 5000AI-M12's information, and then double click the left mouse button.

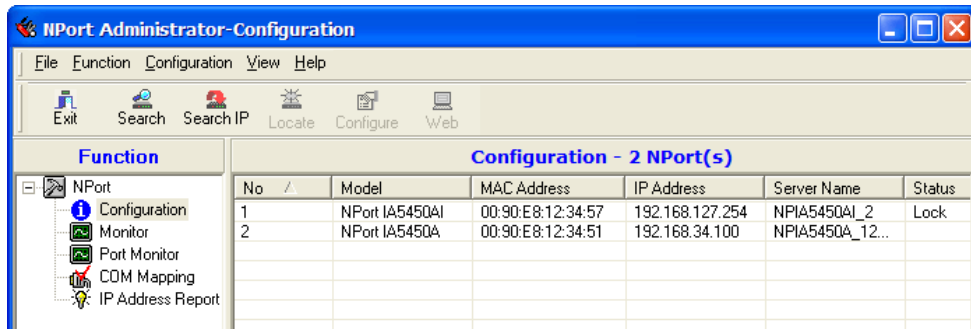

ATTENTION

Before modifying the NPort 5000AI-M12's configuration, use **Broadcast Search** to locate all NPort 5000AI-M12s connected to the LAN, or use **Specify by IP Address** to locate a particular NPort 5000AI-M12.

Unlock Password Protection

If the NPort 5000AI-M12 is password protected (indicated by "Lock" for Status), you will receive the following error, and you will not be able to use the right click method to open the configuration page.

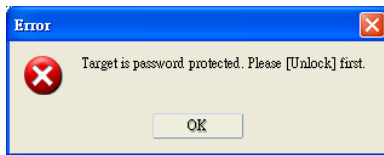

In this case, proceed as follows to "Unlock" the device server.

- Select the NPort 5000AI-M12 with "Lock" status, click the right mouse button, and then select **Unlock**.

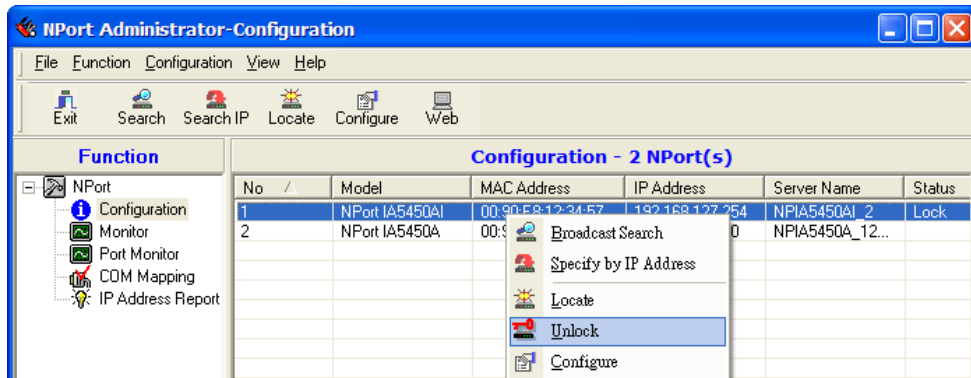

- After inputting the correct password, the Administrator will display an "Unlock ok" message.

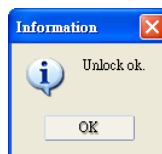
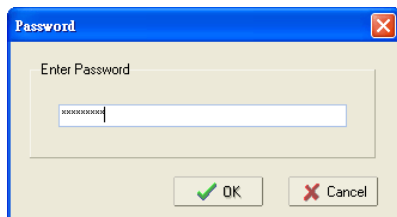

- The "Lock" status will change to "Unlock," and the Administrator utility will keep this NPort 5000AI-M12 in the Unlock status throughout this Administrator session.

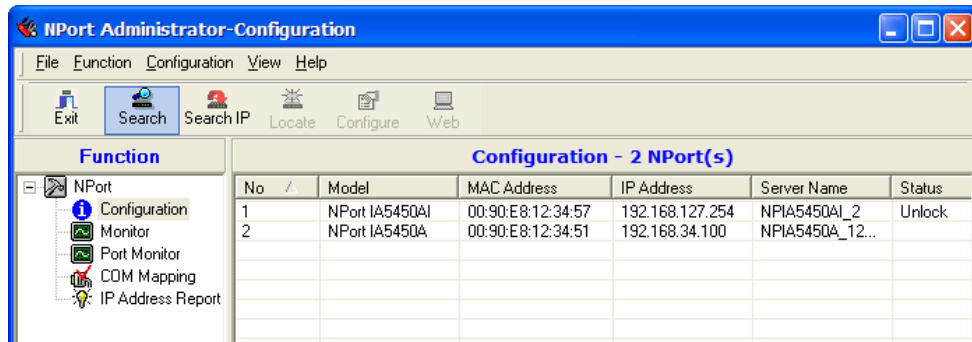

The meanings of the six "Status" states are given below (note that the term Fixed is borrowed from the standard fixed IP address networking terminology):

Lock

The NPort 5000AI-M12 is password protected, "Broadcast Search" was used to locate it, and the password has not yet been entered from within the current Administrator session.

Unlock

The NPort 5000AI-M12 is password protected, "Broadcast Search" was used to locate it, and the password has been entered from within the current Administrator session. Henceforth during this Administrator session, activating various utilities for this NPort 5000AI-M12 will not require re-entering the server password.

Blank

The NPort 5000AI-M12 is not password protected, and "Broadcast Search" was used to locate it.

Fixed

The NPort 5000AI-M12 is not password protected, and "Search by IP address" was used to locate it.

Lock Fixed

The NPort 5000AI-M12 is password protected, "Specify by IP address" was used to locate it, and the password has not yet been entered from within the current Administrator session.

Unlock Fixed

The NPort 5000AI-M12 is password protected, "Specify by IP address" was used to locate it, and the password has been entered from within the current Administrator session. Henceforth during this Administrator session, activating various utilities for this NPort 5000AI-M12 will not require re-entering the server password.

Configuring the NPort 5000AI-M12

In this section, we illustrate how to access the NPort 5000AI-M12's configuration utility. You should first make sure that you can connect over the network from your computer to the NPort 5000AI-M12.

- To start NPort Administrator, click **Start → NPort Administration Suite → NPort Administrator**.

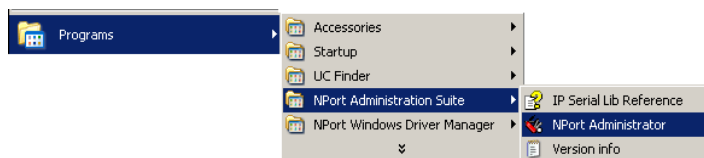

- Unlock the NPort 5000AI-M12 you wish to configure if it is password protected. Right click the NPort 5000AI-M12 and select Configure to start the configuration.

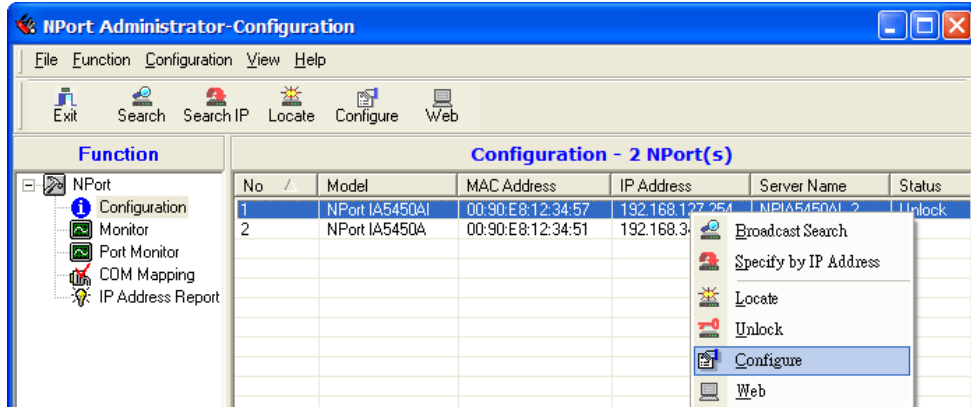

- The progress bar shows that Administrator is retrieving configuration information from the specific NPort 5000AI-M12.

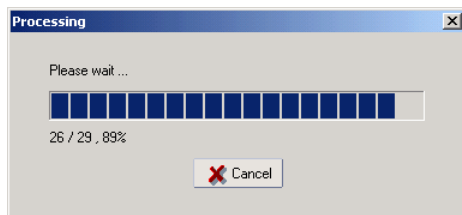

- Refer to Chapter 5 for each parameter’s function definition. To modify the configuration, you must first click in the modify box to activate the parameter setting box.

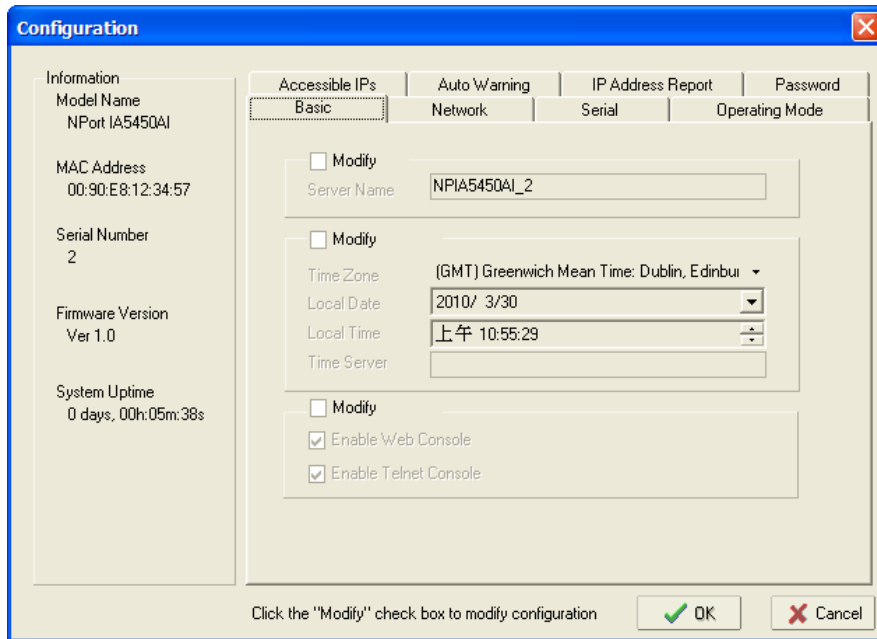

ATTENTION

You can simultaneously modify the configurations of multiple NPort 5000AI-M12s that are of the same model. To select multiple NPort 5000AI-M12s, hold down the Ctrl key when selecting additional NPort 5000AI-M12s, or hold down the Shift key to select a group of NPort 5000AI-M12s.

Upgrading the Firmware

Follow these steps to upgrade the firmware of an NPort 5000AI-M12.

1. To start NPort Administrator, click **Start → NPort Administration Suite → NPort Administrator**.

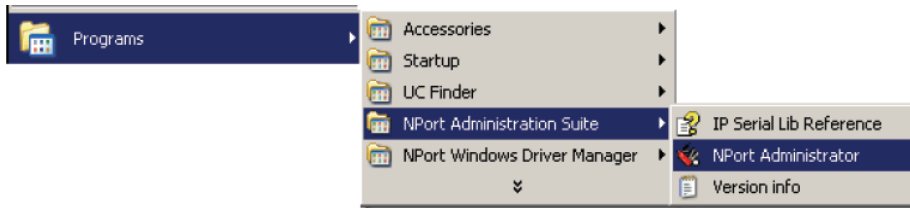

2. Unlock the NPort 5000AI-M12 you wish to configure if it is password protected. Right click a specific NPort 5000AI-M12 and select the **Upgrade Firmware** function to start upgrading the firmware.

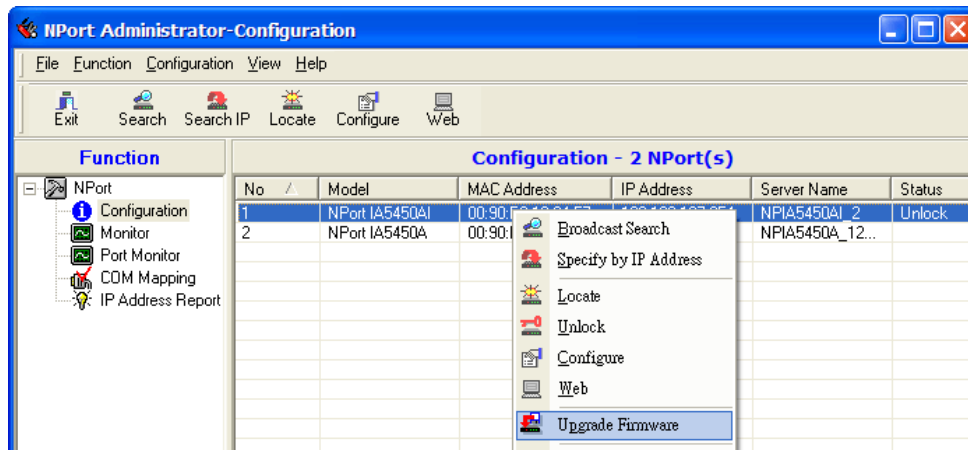

3. Select the correct ROM file to download.

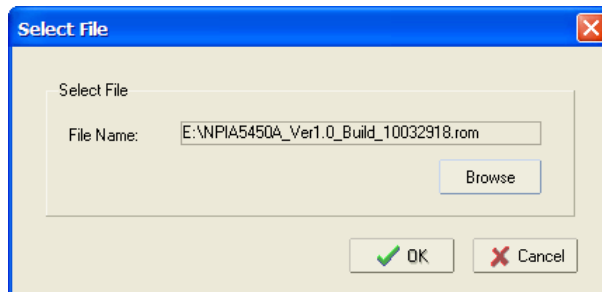

4. Wait while the Upgrade Firmware action is processed.

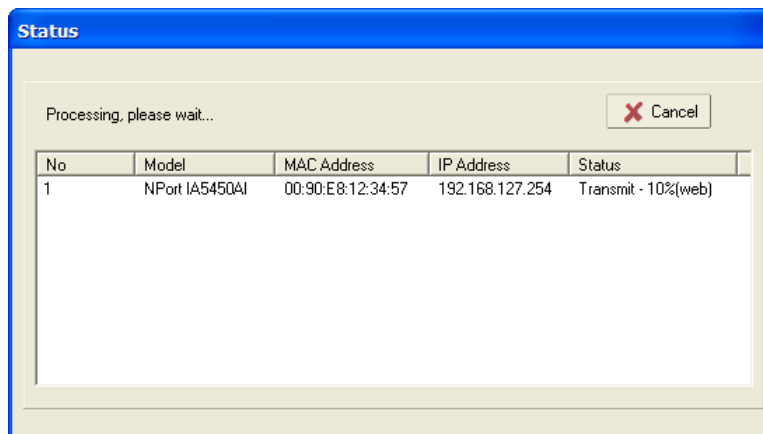



ATTENTION

You can simultaneously upgrade the firmware of multiple NPort 5000AI-M12s that are of the same model. To select multiple NPort 5000AI-M12s, hold down the Ctrl key when selecting an additional NPort 5000AI-M12, or hold down the Shift key to select a block of NPort 5000AI-M12s.

Export Configuration

To export the configuration of an NPort 5000AI-M12, right click the NPort 5000AI-M12, select **Export Configuration**, and then follow the onscreen instructions. The Export Configuration function is a handy tool that can be used to produce a text file containing the current configuration of a particular NPort 5000AI-M12.

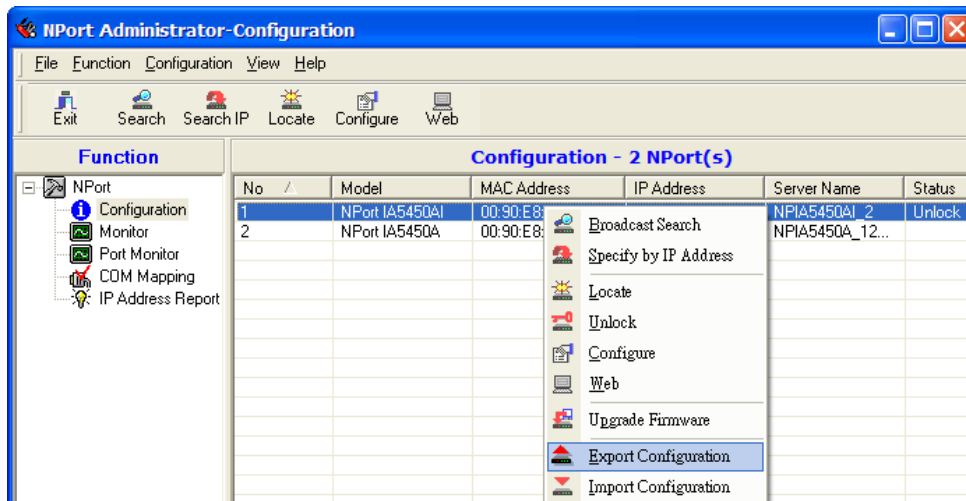

Import Configuration

The Import Configuration function is used to import an NPort 5000AI-M12 configuration from a file into one or more of the same model NPort 5000AI-M12. To import a configuration, first select the target servers, click the right mouse button, and then select **Import Configuration**. Follow the onscreen instructions to locate the configuration file and start downloading the file.

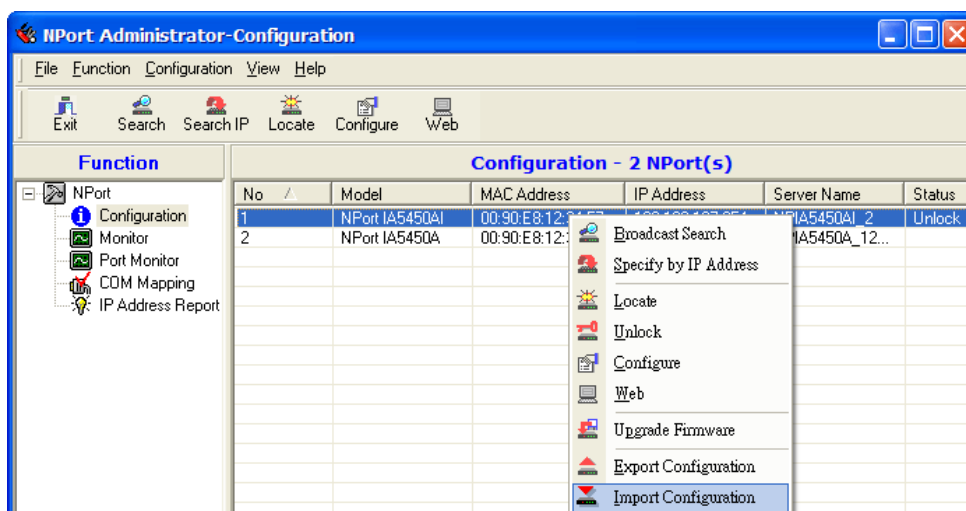



ATTENTION

You can simultaneously import the same configuration file into multiple NPort 5000AI-M12s that are of the same model.

To select multiple NPort 5000AI-M12s, hold down the Ctrl key when selecting an additional NPort 5000AI-M12, or hold down the Shift key to select a block of NPort 5000AI-M12s.

Monitor

Use following method to start the Monitor function.

Broadcast Search → Monitor → Add Target

1. With Configuration selected under Function, use Broadcast Search to locate all NPorts on your LAN.

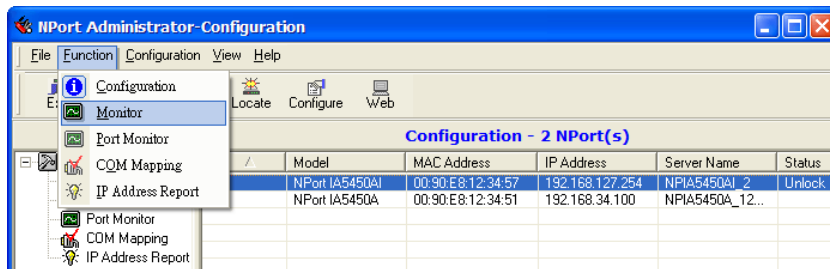

2. Next, click **Monitor → Add Target** and select your targets from the list, and then click **OK**.

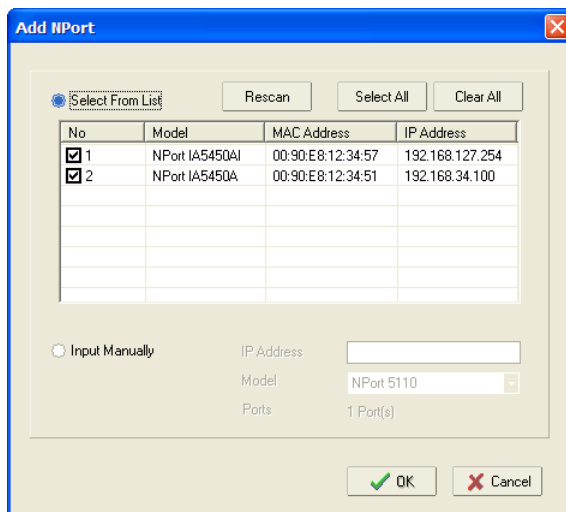
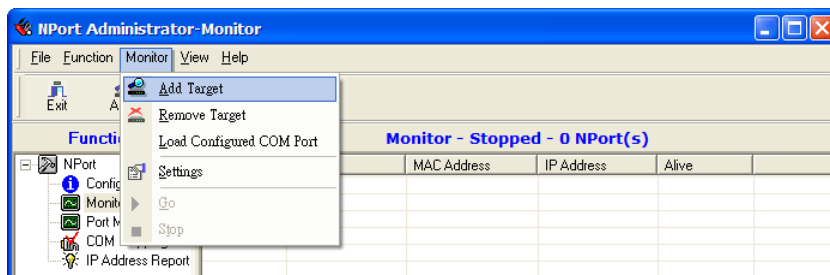

Once the Monitor function is running:

- The NPort 5000AI-M12 list will appear on the Monitor screen.

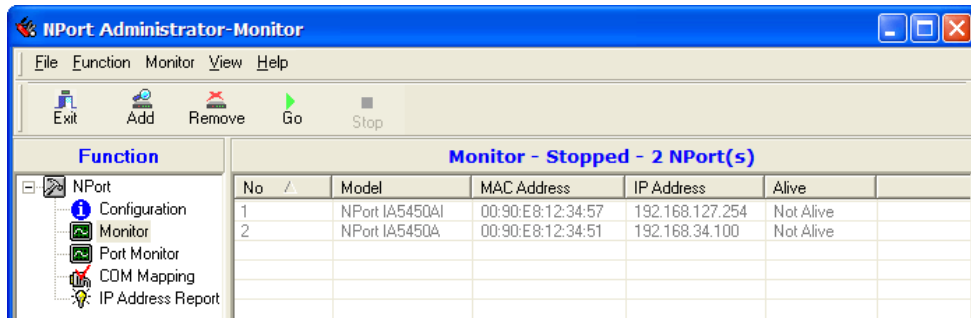

- Right click the panel and select **Settings**.

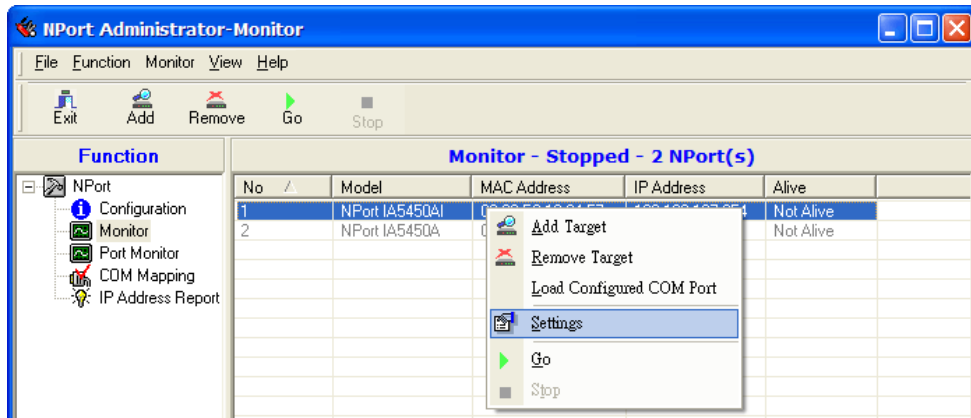

- Select or de-select **Monitor Items**. Use the single arrowhead buttons to move highlighted items from one box to the other. Use the double arrowhead buttons to move all items in one box to the other.

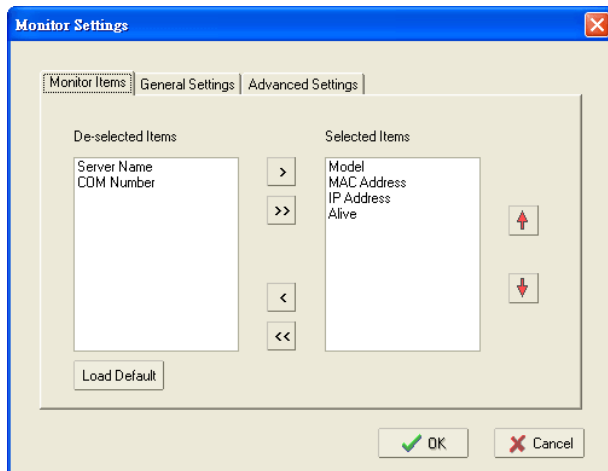

- Select a **Refresh Rate** (the default is 3 seconds) on the General Settings page.

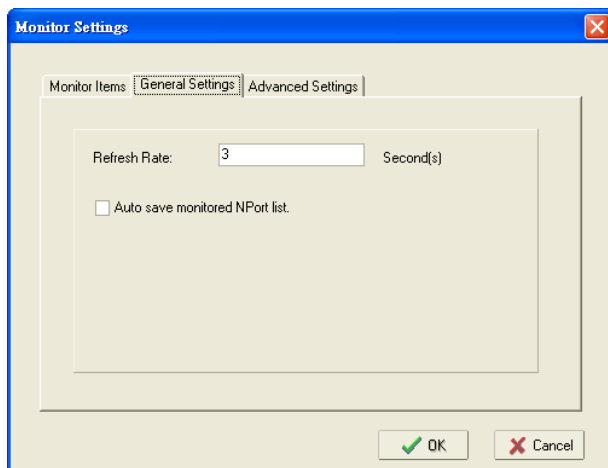

- On the **Advanced Settings** page, select **Display warning message for new event** and/or **Play warning music for new event**. In the second case, you must enter the path to the WAV file that you want to be played. "New event" means that one of the NPort 5000AI-M12s in the monitor is "Alive" or "Not Alive," or has lost connection with the Monitor program.

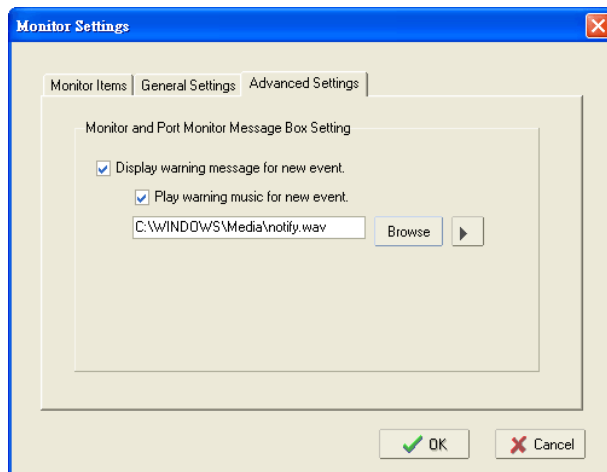

- Right click in the NPort 5000AI-M12 list section and select **Go** to start Monitoring the NPort 5000AI-M12.

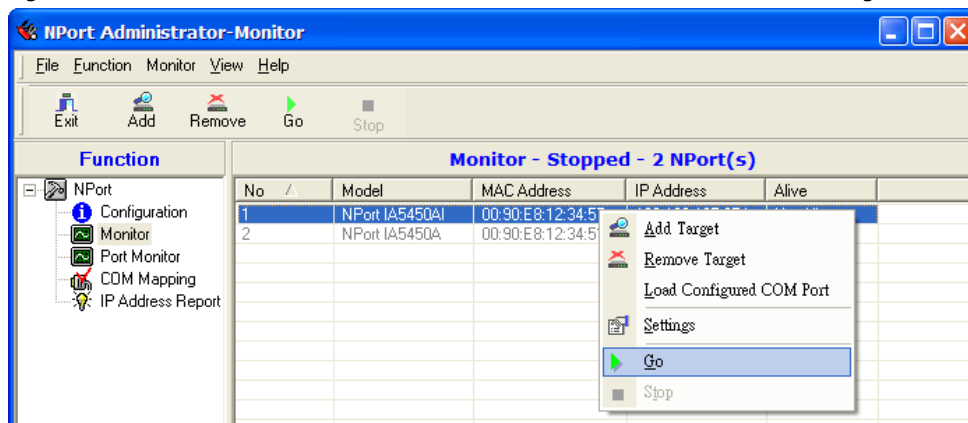

- For this example, the NPort 5000AI-M12s shown in the list will be monitored.

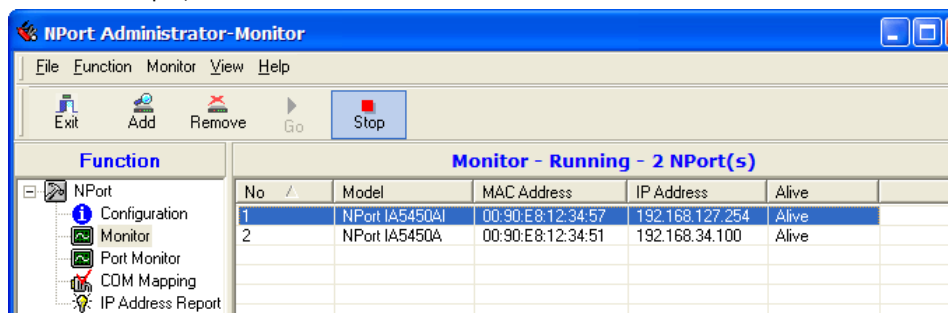

- When one of the NPort 5000AI-M12s loses connection with the Monitor program, a warning alert will display automatically. The warning music will be played at the same time.

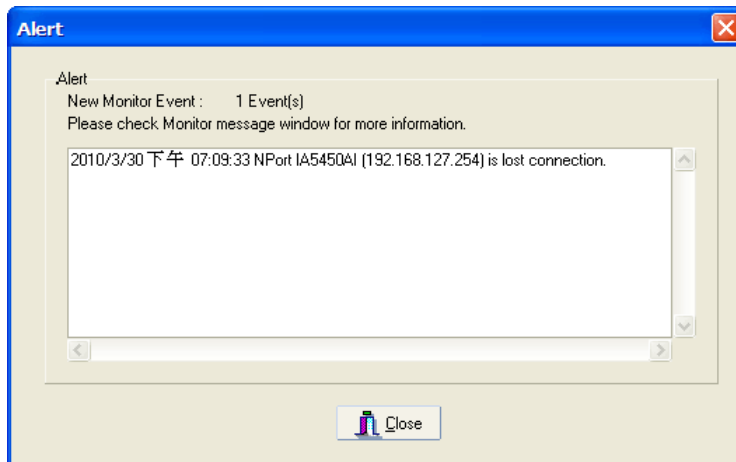

- In the Monitor screen, you can see that the NPort 5000AI-M12s that are "Not Alive" are shown in red color.

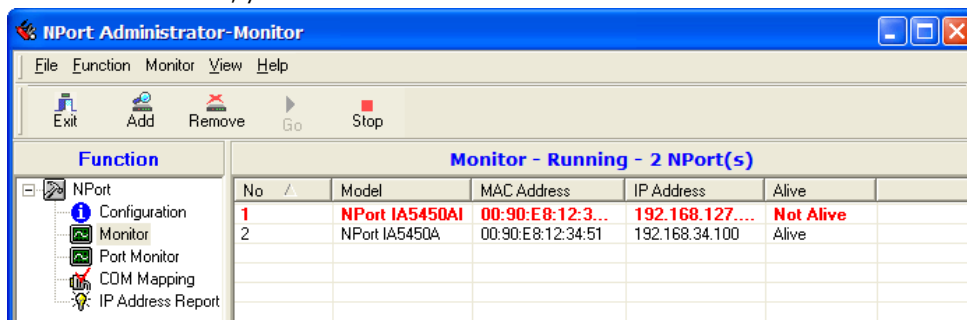

- If the NPort 5000AI-M12 gets reconnected, a warning will be displayed to remind the user that the NPort 5000AI-M12 is now "Alive."

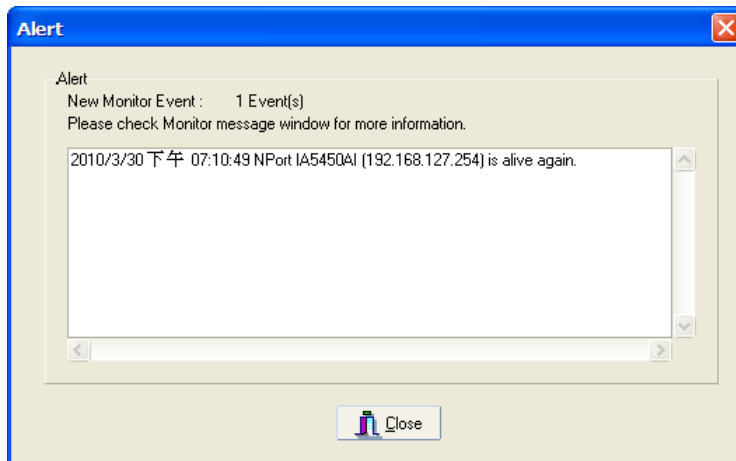

- The NPort 5000AI-M12s that were reconnected, and are now "Alive," will be shown in black color.

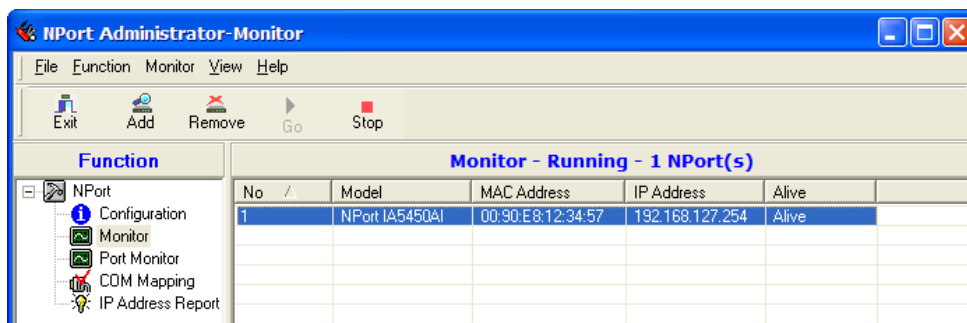

Port Monitor

The process described here is the same as in the previous "Monitor" section. The only difference is that you can select more items under Port Monitor than under Monitor.

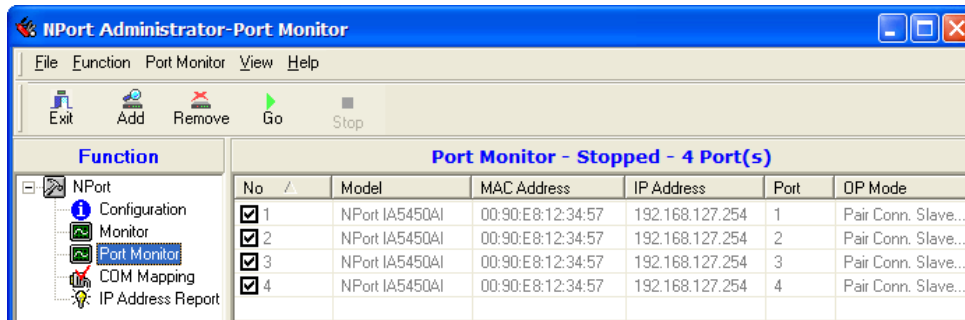

Select or de-select **Monitor Items**. Use the single arrowhead buttons to move highlighted items from one box to the other. Use the double arrowhead buttons to move all items in one box to the other.

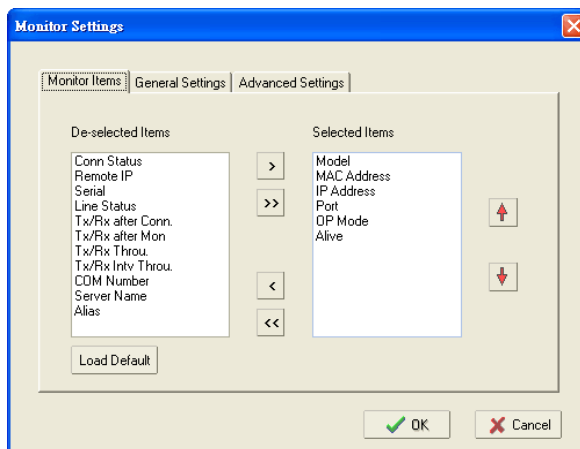

COM Mapping

Windows Administration Suite comes with Windows 95/98/ME/NT/2000/XP/7 Real COM drivers. After you install NPort Administration Suite, there are two ways to set up the NPort 5000AI-M12 serial port as your host's remote COM port.

The first way is with **On-line COM Mapping**. On-line COM Mapping will check to make sure that the NPort 5000AI-M12 is connected correctly to the network and then install the driver on the host computer.

The second way is with **Off-line COM Installation**, without first connecting the NPort 5000AI-M12 to the network. Off-line COM Mapping can decrease the system integrator's effort by solving different field problems. Via off-line installation, users can first process software installation for the host, and then install the NPort 5000AI-M12 to different fields.

Use the following procedure to map COM ports:

1. On-line COM Mapping:
Connect the NPort 5000AI-M12 to the network → Set the NPort 5000AI-M12 to the proper IP address → Map COMs to your host → Apply Change.
2. Off-line COM Mapping:
Map COMs to your host → Apply Change → Connect the NPort 5000AI-M12 to the network → Configure the NPort 5000AI-M12's IP address.

On-line COM Mapping

1. Broadcast Search for NPort 5000AI-M12s on the network.

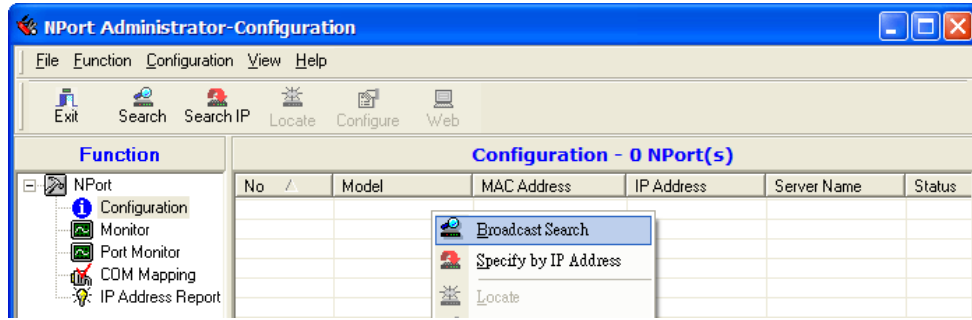

2. Select the **COM Mapping** function group.

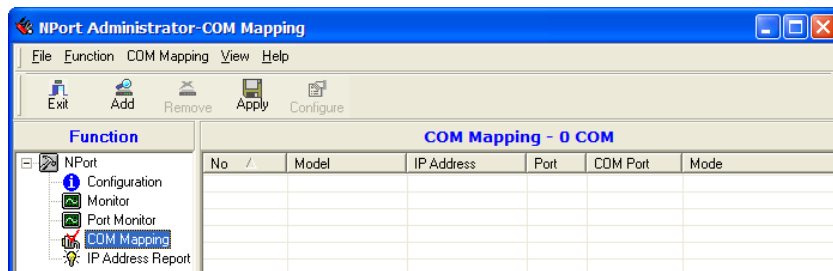

3. Add the target to which you would like to map COM ports.

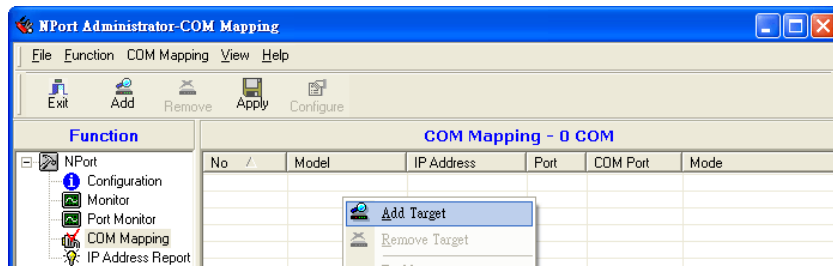

4. The NPort 5000AI-M12 list that appears is the list generated by the previous Broadcast Search. Select the NPort 5000AI-M12 to which you would like to map COM ports.

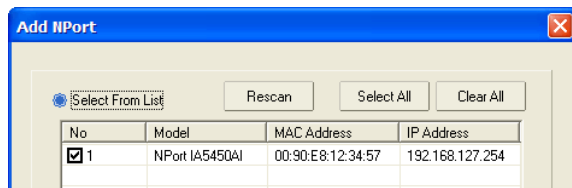

5. Select **COM Settings** to modify COM No., default setting, etc.

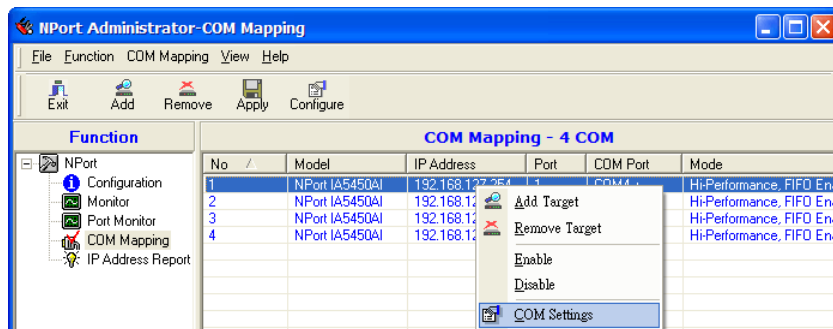

6. Select the **COM Number**.

COM ports that are "In use" or "Assigned" will also be indicated in this drop-down list. If you select multiple serial ports or multiple NPort 5000AI-M12s, remember to check the "Auto Enumerating" function to use the COM No. you select as the first COM No.

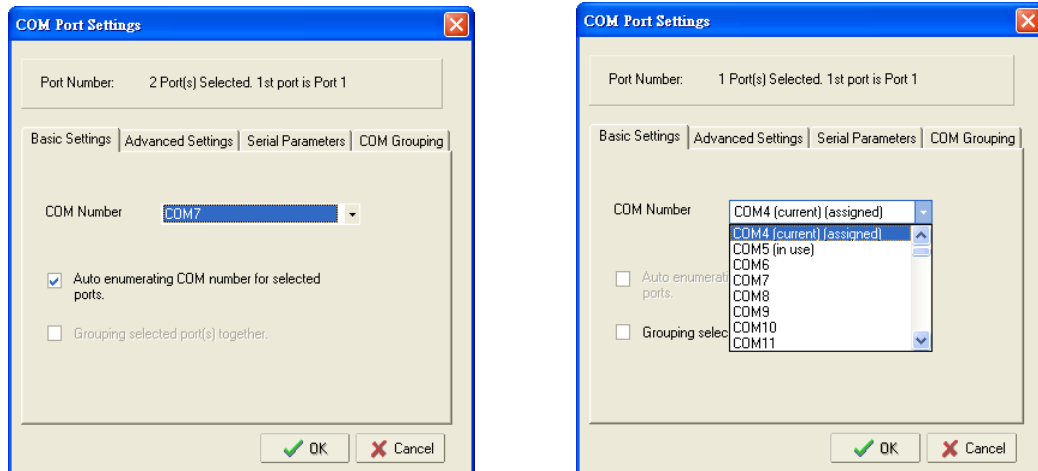
7. **Hi-performance** mode is the default for Tx mode. If the driver completes sending data out to the NPort 5000AI-M12, the driver will respond "Tx Empty" to the program.

Under **classical mode**, the driver will not notify the user's program that Tx is completed until all Tx data has been sent out from the NPort 5000AI-M12; this mode will cause lower throughput. If you want to ensure that all data is sent out before further processing, classical mode is recommended.

Enable/Disable Tx/Rx FIFO. If disabled, the NPort 5000AI-M12 will send one byte each time the Tx FIFO becomes empty; and an Rx interrupt will be generated for each incoming byte. This will result in a faster response and lower throughput. If you want to use XON/XOFF flow control, we recommend setting FIFO to Disable.

Fast Flush (only flush local buffer)

- For some applications, the user's program will use the Win32 "PurgeComm()" function before it reads or writes data. With our design, after the program uses this Purge Comm() function, the NPort driver will keep querying the NPort's firmware several times to make sure there is really no data queued in the NPort firmware buffer, rather than just flushing the local buffer. This kind of design is used because of some special considerations. However, it might take more time (on the order of several hundred milliseconds) than a native COM1, because it needs to work via Ethernet. That's why the native COM ports on the motherboard can work fast with this function call, but the NPort requires much more time. In order to accommodate other applications that require a faster response time, the new NPort driver implements a new "Fast Flush" option. Note that by default, this function is disabled.
- To begin with, make sure there are some "PurgeComm()" functions being used in your application program. In this kind of situation, you might find that your NPort exhibits a much poorer operation performance than when using the native COM1 port. Once you have enabled the "Fast Flush" function, you can check to see if there has been an improvement in performance.
- By default, the optional "Fast Flush" function is disabled. If you would like to enable this function, from the "NPort Administrator," double click the COM ports that are mapped to the NPort, and then select the "Fast Flush" checkbox. You should find that when "Fast Flush" is enabled, the NPort driver will work faster with "PurgeComm()."

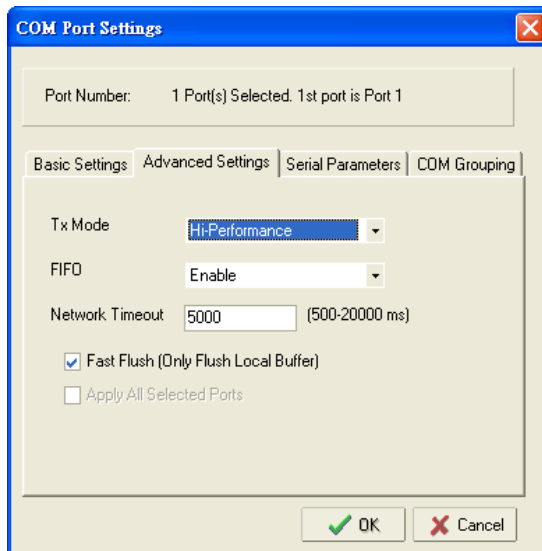

- The Serial Parameter settings shown here are the default settings when the NPort 5000AI-M12 is powered on. However, the program can redefine the serial parameters to different values after the program opens the port via Win32 API.

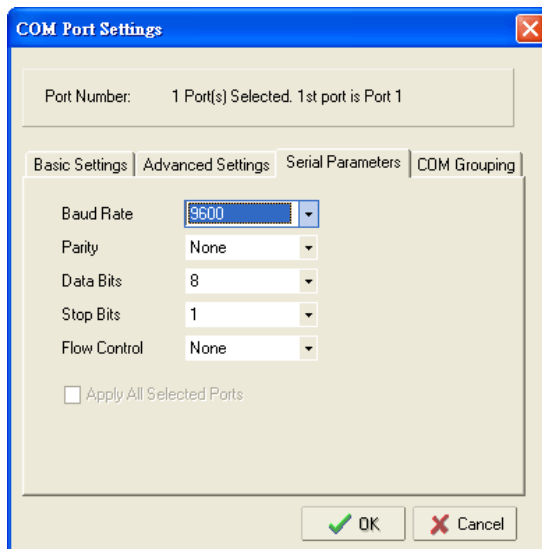

- After setting the COM Mapping, remember to select **Apply Change** to save the information in the host system registry. The host computer will not have the ability to use the COM port until after **Apply Change** is selected.

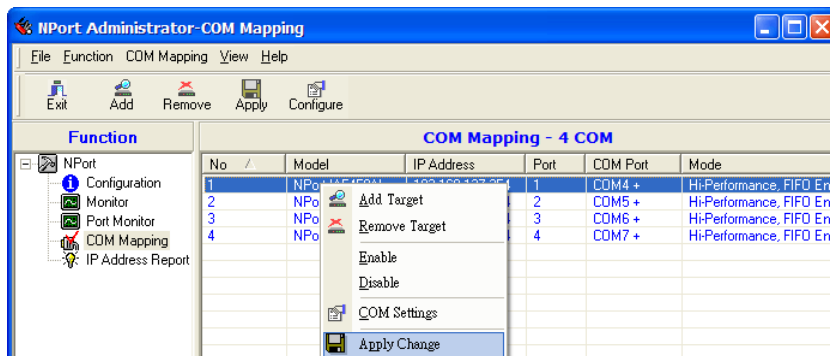

10. Select **Discard Change** to tell Administrator NOT to save the COM Mapping information to the host.

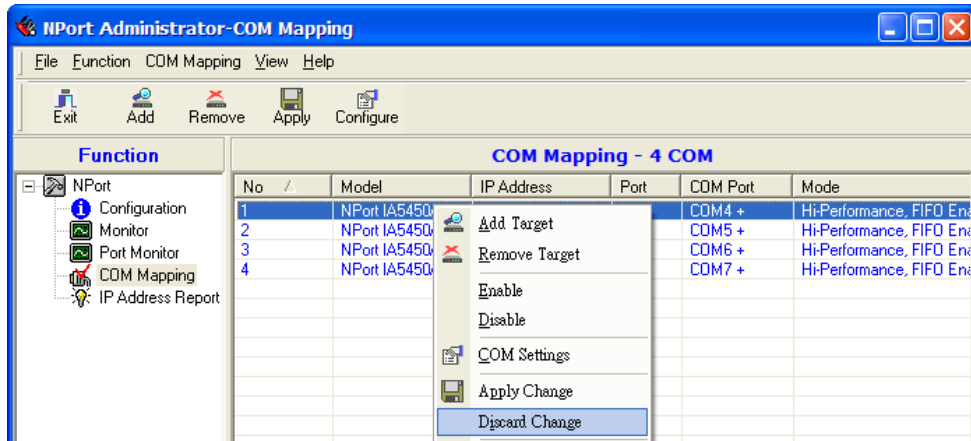

11. To save the configuration to a text file, select **Export COM Mapping**. You will then be able to import this configuration file to another host and use the same COM Mapping settings in the other host.

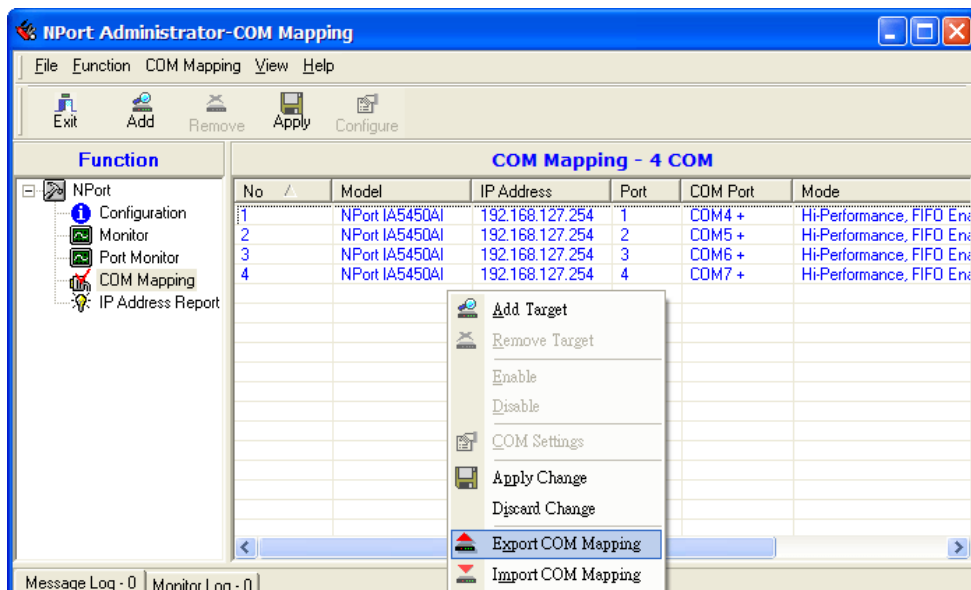

Off-line COM Mapping

1. Add a target by inputting the IP address and selecting the Model Name without physically connecting the NPort 5000AI-M12 to the network.

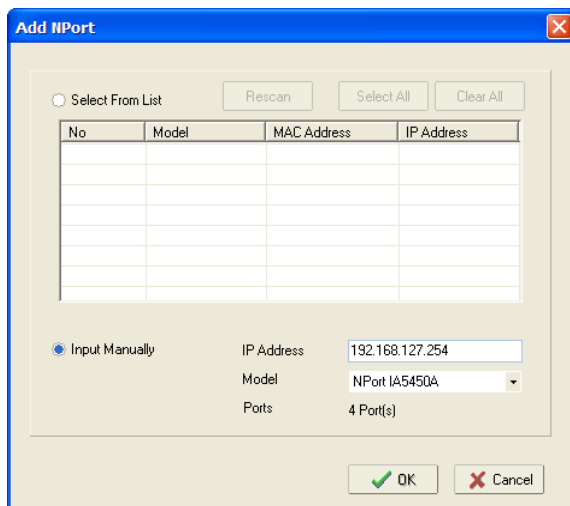

2. Modify the port settings as needed.

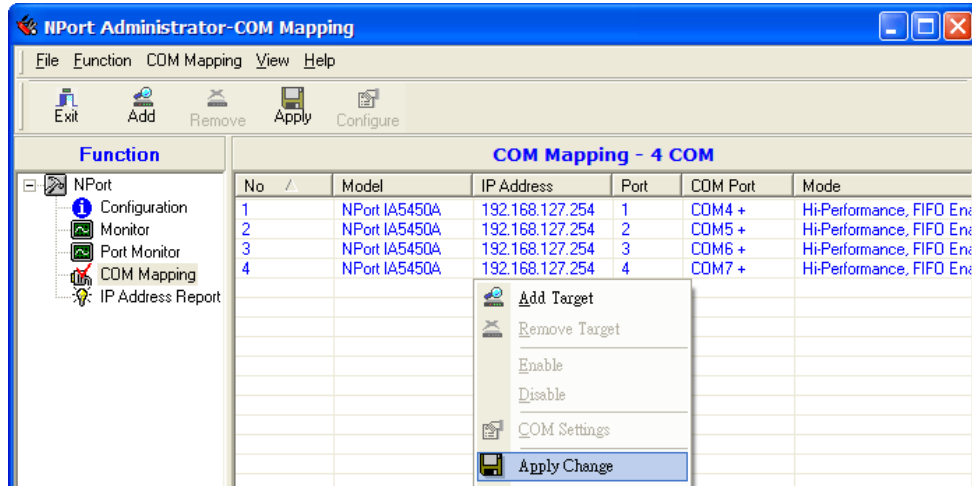

3. Right click in the NPort list section and select **Apply Change**.

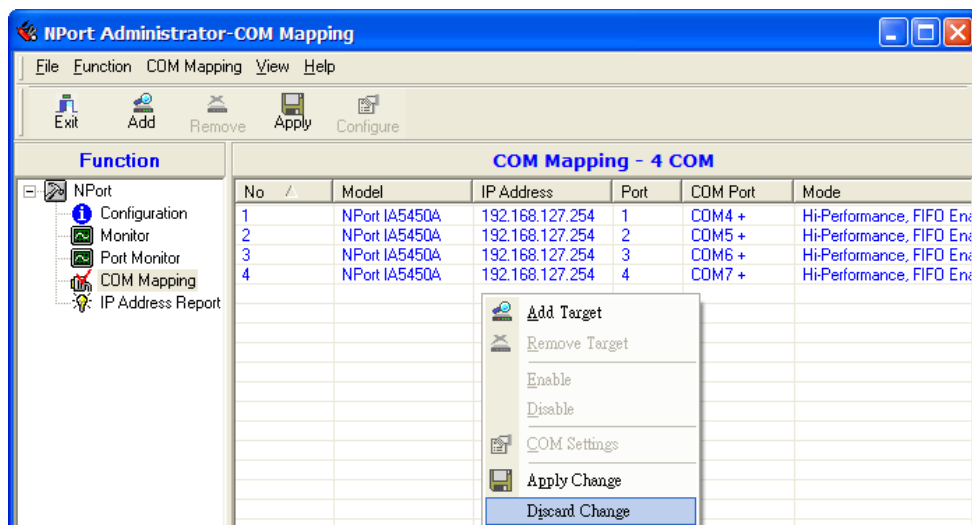

COM Grouping

The "COM Grouping" function is designed to simulate the multi-drop behavior of serial communication over an Ethernet network. COM Grouping allows you to create a COM Group and redirect data from it to several physical COM ports on NPort device servers. With COM Grouping, you will be able to control multiple physical serial ports simultaneously by operating only one COM port.

Creating a COM Group

Follow the steps below to add multiple COM ports into one group:

1. Select serial port(s) for the group that you are going to create, and right-click to select **COM Settings**.

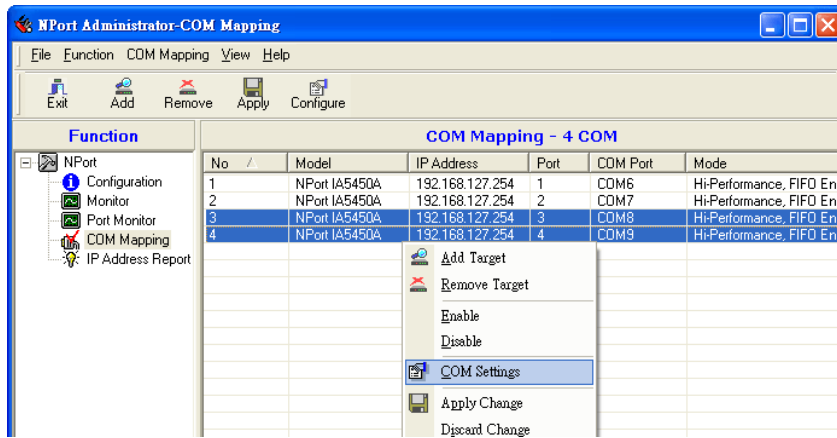

2. Select a COM number for this COM group. You may select one of the ports already assigned to a member of the COM Group. However, once the COM Group is configured, all of the original COM number(s) within the group will be released simultaneously.

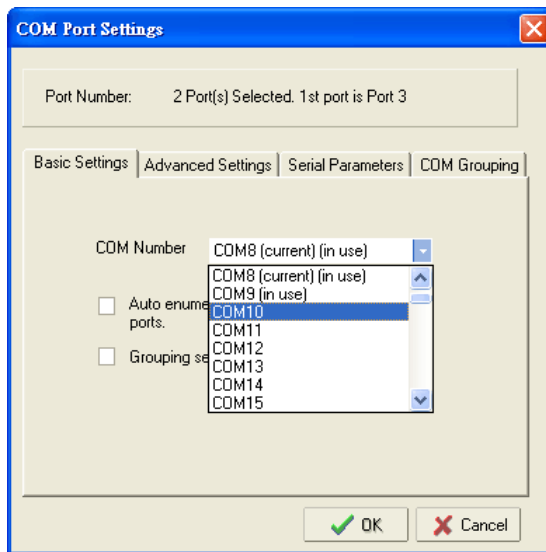

ATTENTION

The COM Grouping function only supports Windows NT, 2000, and later. The maximum number of ports for each group is 32.

3. Select the **Grouping selected port(s) together** checkbox.

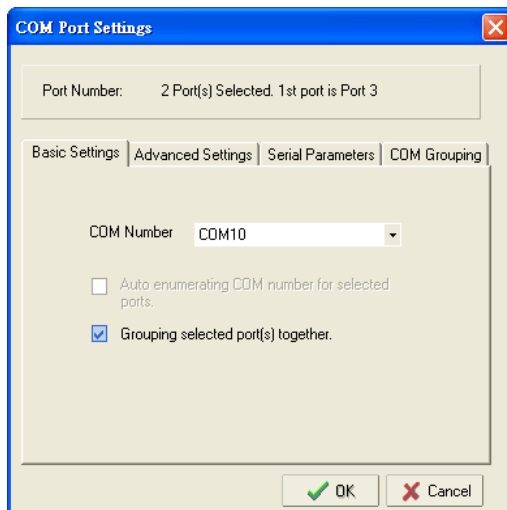

- On the **COM Grouping** page, you can set "Read" and "Write" permissions for every serial port. It is necessary to set **Signal Status** in order to control the data transmission with specified control signals (e.g., DTR/RTS). You can assign one serial port whose signals will be taken into account by the COM Group.

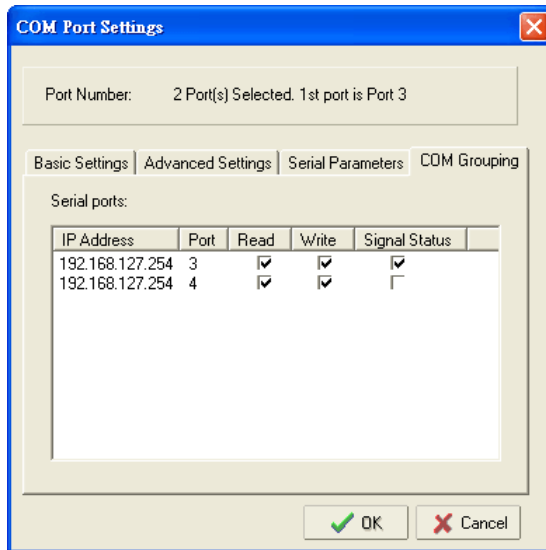

- Click OK, and confirm that the serial ports that were assigned. The COM Port column confirms that your selected ports are labeled as part of a "Group." You will be able to view the serial ports that were assigned to and removed from the Group. Click **Apply** to apply the settings.

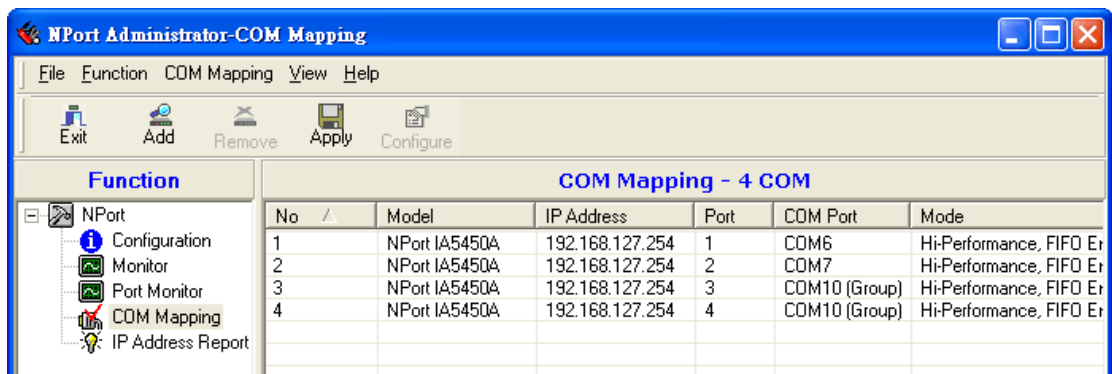

- Finally, click Yes to confirm.

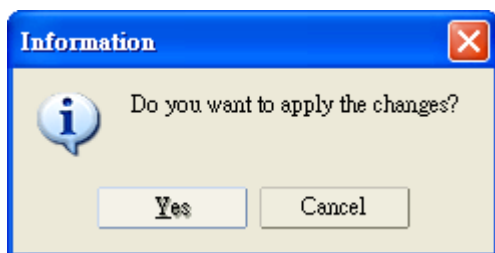

Deleting a COM Group

Follow the steps below to delete a COM Group and then auto-assign COM numbers for each port in the Group:

- Select all serial ports in the Group you are deleting and then right-click to select **COM Settings**.

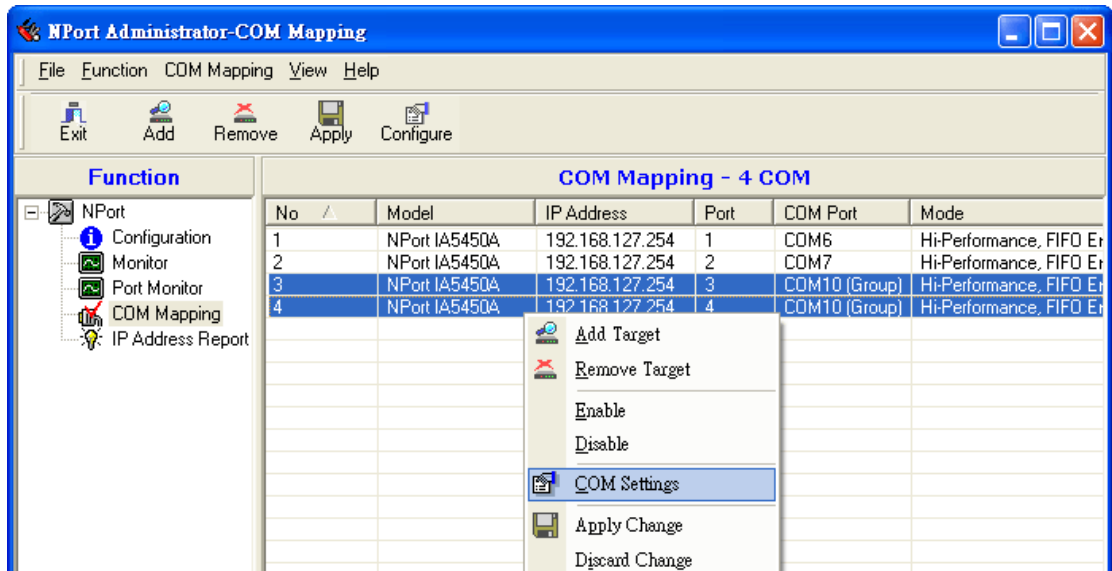

2. Select a COM number for this COM group and check the **Auto enumerating COM number for selected ports** to use the COM number you select as the first starting COM number, and then click OK.

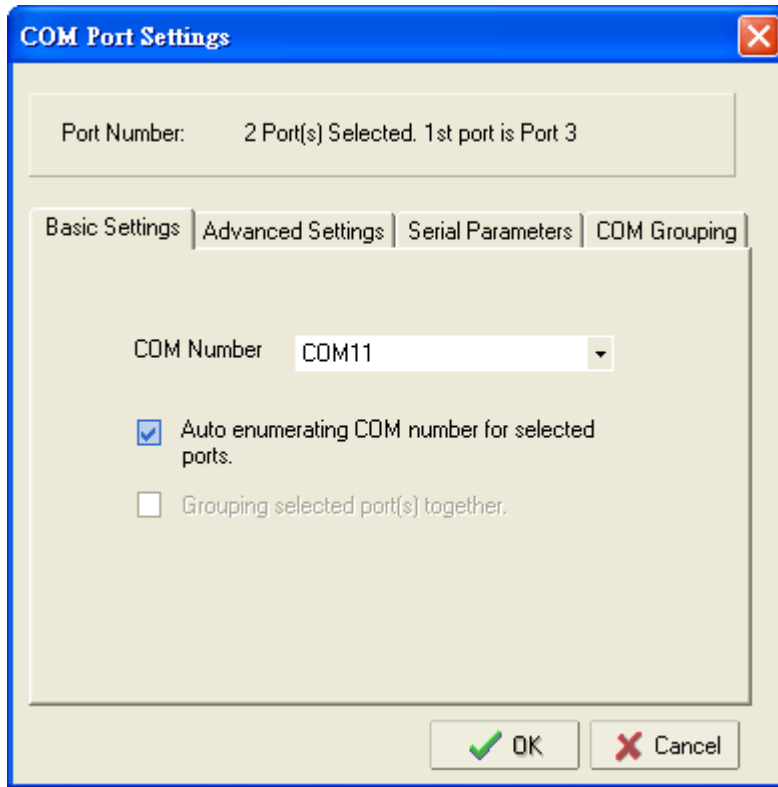

3. You will be able to view the serial ports that were assigned to and removed from the Group. Click **Apply** to apply the settings.

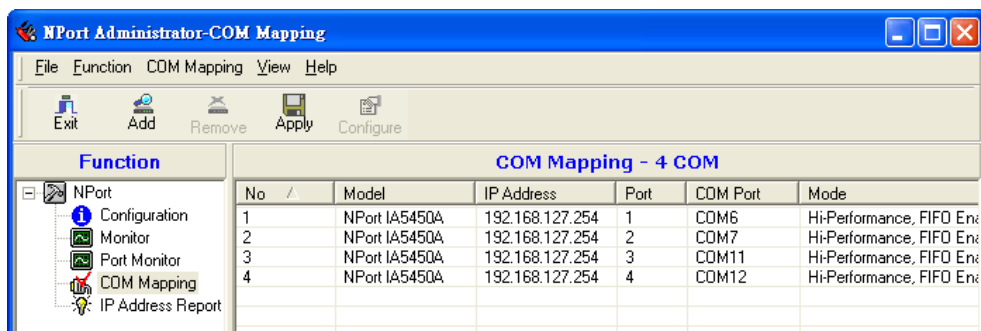

4. Finally, click Yes to confirm.

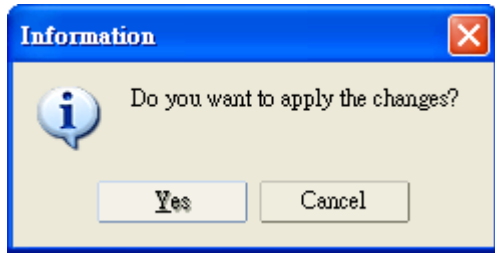

Adding a Port to a COM Group

Follow the steps below to add a serial port into an existing COM Group:

1. Select the serial port that you are adding and right-click to select **COM Settings**.

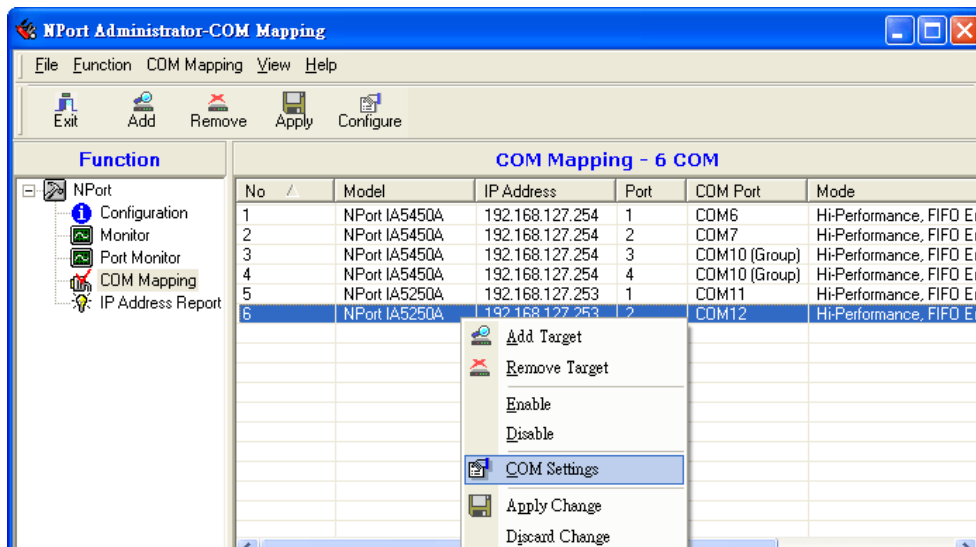

2. Select the COM number of the COM Group you are adding and check mark the **Grouping selected port(s) together** check box and then click OK.

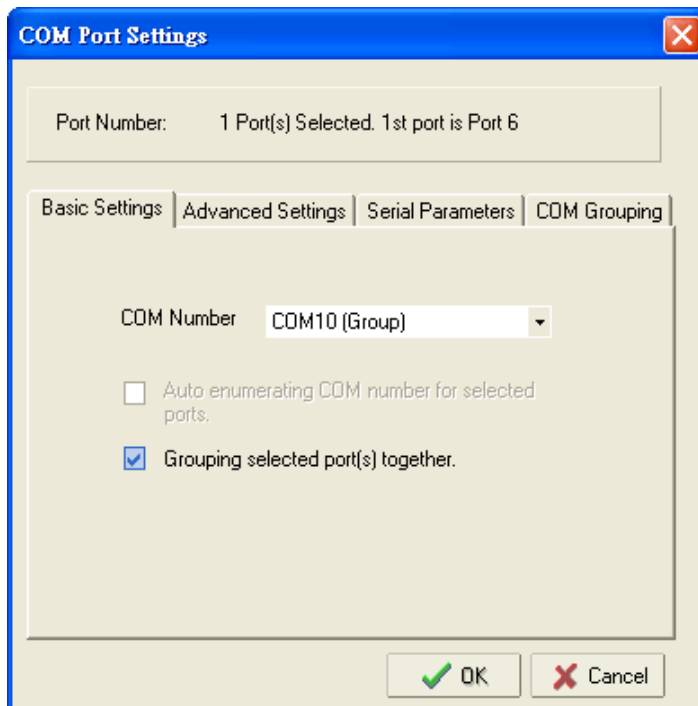

- You will be able to view the serial ports that were assigned to and removed from the Group. Click **Apply** to apply the settings.

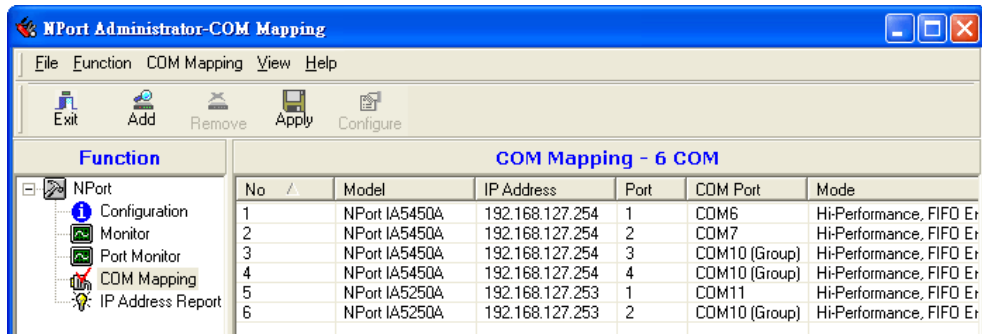

- Finally, click Yes to confirm.

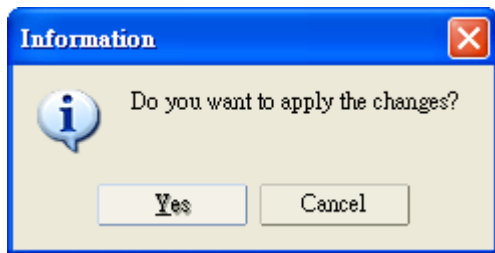

Removing a Port from a COM Group

Follow the steps below to remove a serial port from a COM Group:

- Select a serial port in the Group and right-click to select **COM Settings**.

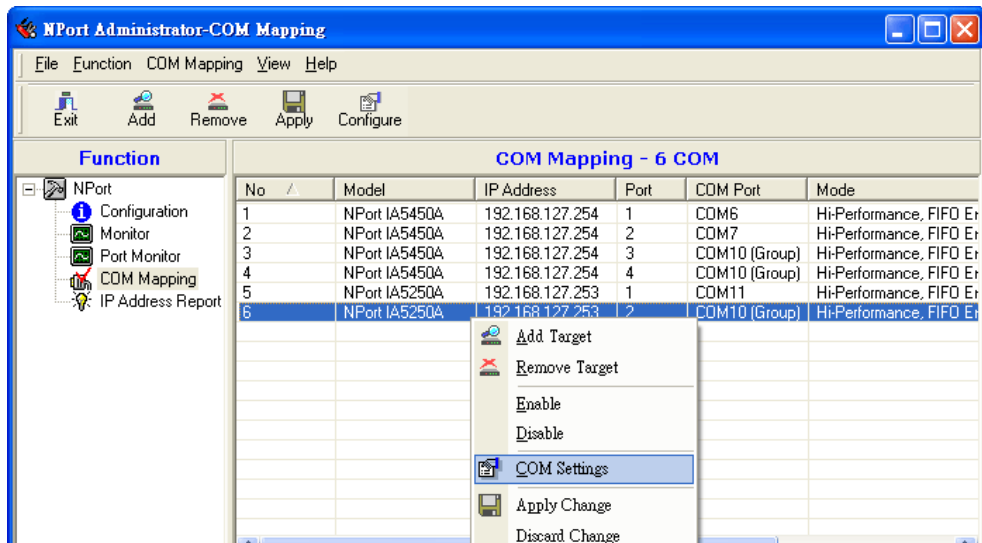

2. Select a COM number that is not in use or assigned to a Group and click OK.

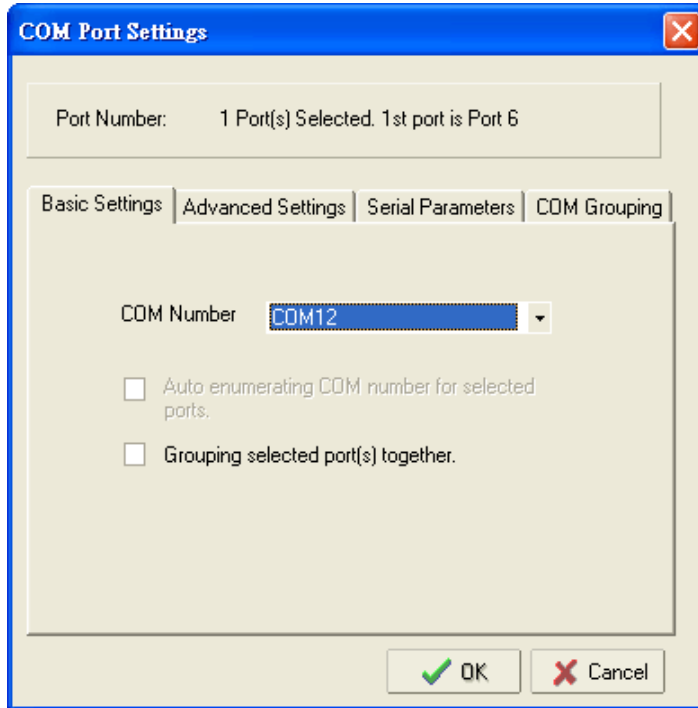

3. You will be able to view the serial ports that were assigned to and removed from the Group. Click **Apply** to apply the settings.

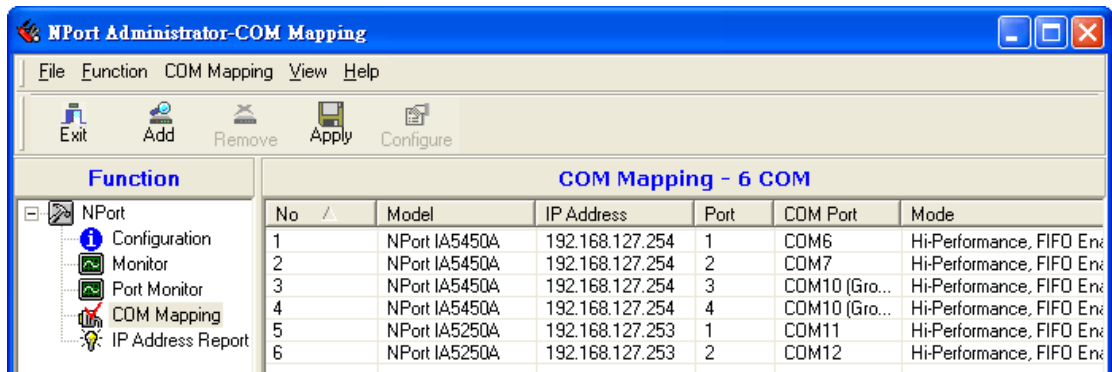

4. Finally, click Yes to confirm.

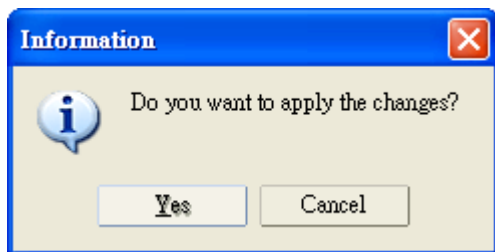

Modify Ports in a COM Group

In the following subsections we examine three ways in which the serial ports in a COM Group can be modified:

Changing the COM Number of a COM Group

1. Select all serial ports in the Group and right-click to select **COM Settings**.

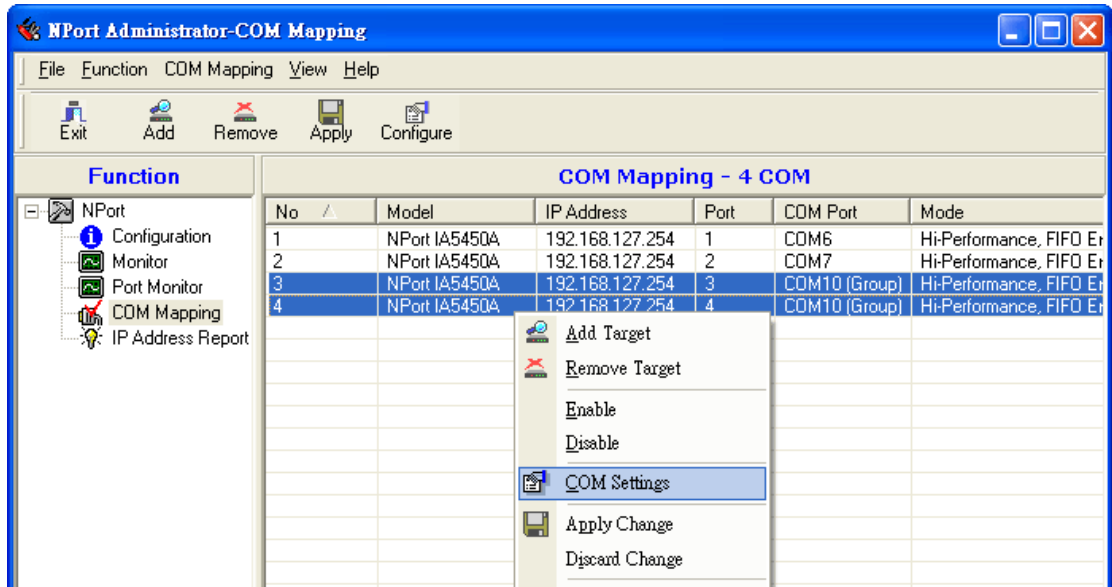

2. Select a COM number that is not in use or assigned to a Group.

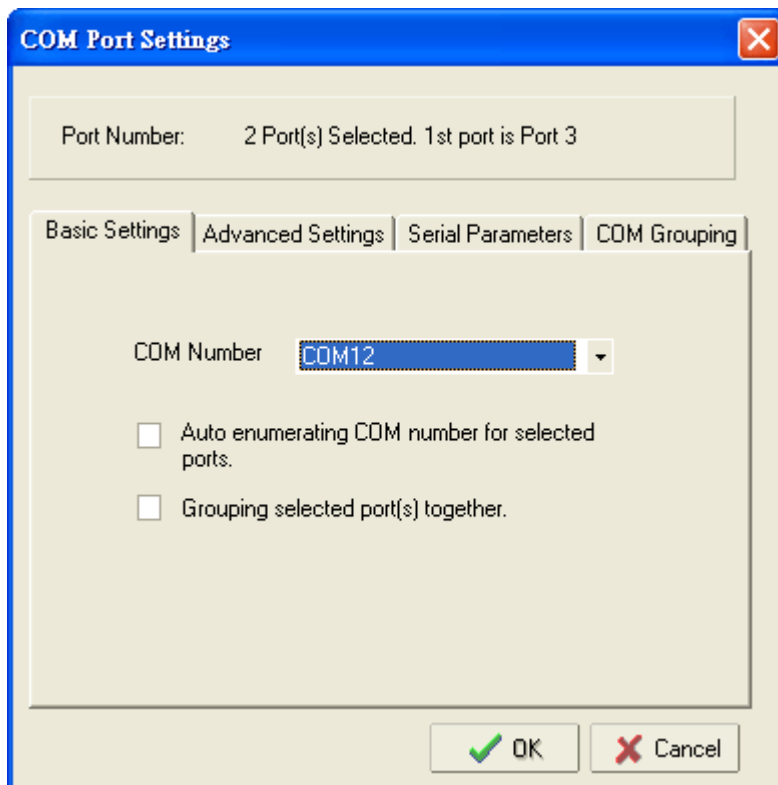

3. Select the **Grouping selected port(s) together** checkbox and then click **OK**.

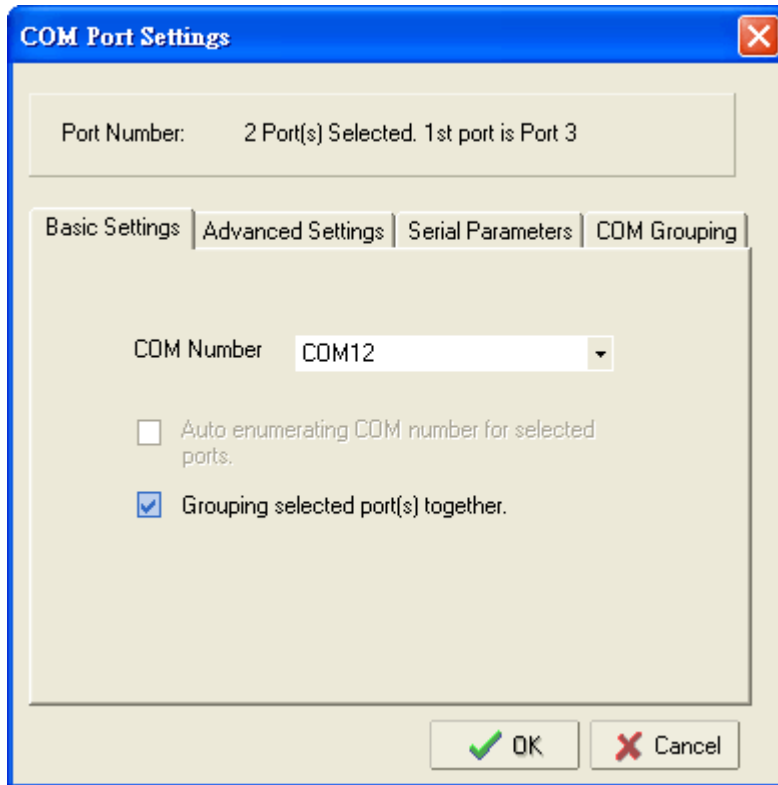

4. You will be able to view the serial ports that were assigned to and removed from the Group. Click **Apply** to apply the settings.

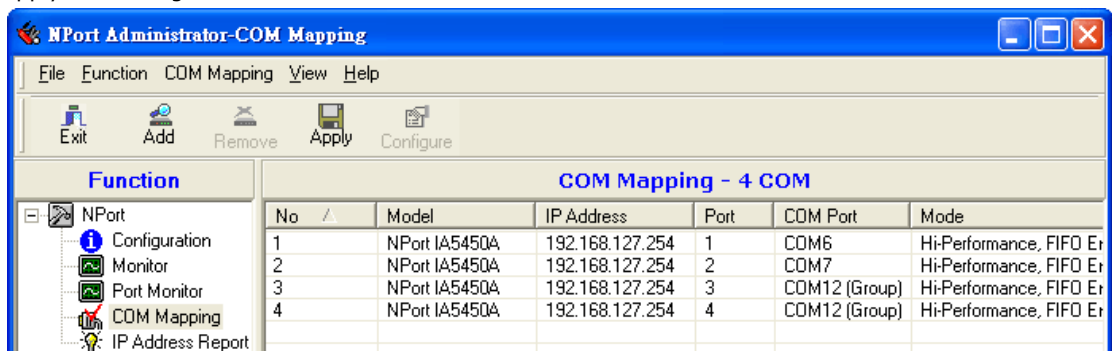

5. Finally, click Yes to confirm.

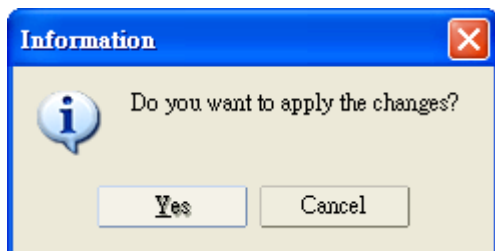

Changing Advanced Settings and Serial Parameters of the COM Group

1. Check the port specified on the **COM Grouping** page as the signal port.

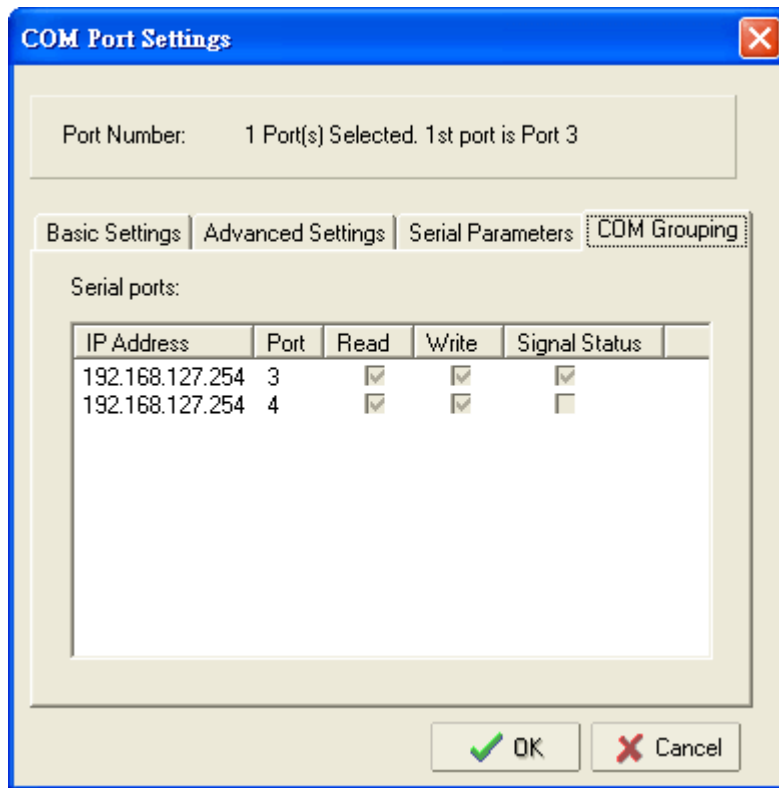

2. Select the "Signal Status" controlled port and then right-click and select **COM Settings**.

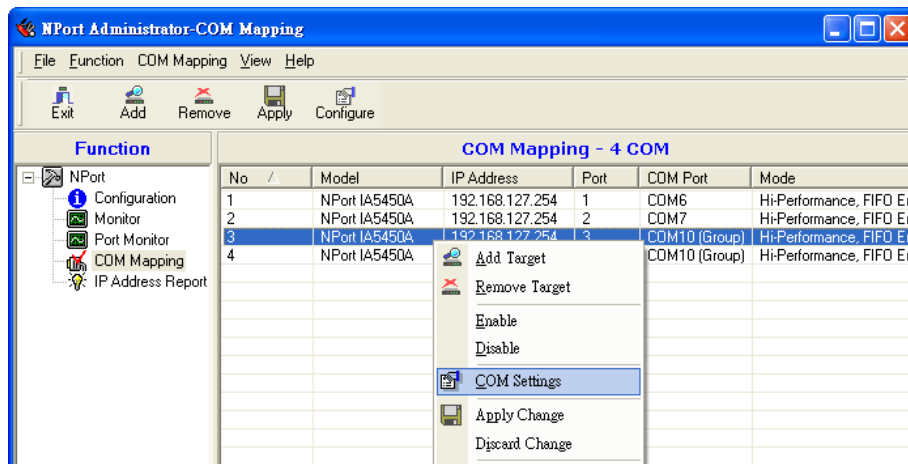

- 3. The **Advanced Settings** and **Serial Parameters** pages will be available for modification.

The screenshot shows the 'COM Port Settings' dialog box with the 'Advanced Settings' tab selected. The 'Port Number' field shows '1 Port(s) Selected. 1st port is Port 3'. The 'Basic Settings' tab is also visible. The 'Advanced Settings' section includes a 'Tx Mode' dropdown set to 'Hi-Performance', a 'FIFO' dropdown set to 'Enable', and a 'Network Timeout' text box with '5000' and '(500-20000 ms)' next to it. There are two checkboxes: 'Fast flush (only flush local buffer)' and 'Apply all selected ports', both of which are currently unchecked. At the bottom, there are 'OK' and 'Cancel' buttons.

The screenshot shows the 'COM Port Settings' dialog box with the 'Serial Parameters' tab selected. The 'Port Number' field shows '1 Port(s) Selected. 1st port is Port 3'. The 'Basic Settings' and 'Advanced Settings' tabs are also visible. The 'Serial Parameters' section includes five dropdown menus: 'Baud Rate' set to '9600', 'Parity' set to 'None', 'Data Bits' set to '8', 'Stop Bits' set to '1', and 'Flow Control' set to 'None'. There is an unchecked checkbox for 'Apply all selected ports'. At the bottom, there are 'OK' and 'Cancel' buttons.

Changing the Serial Port Specified as Signal Port for the COM Group

1. Select a serial port in the Group and then right-click and select **COM Settings**.

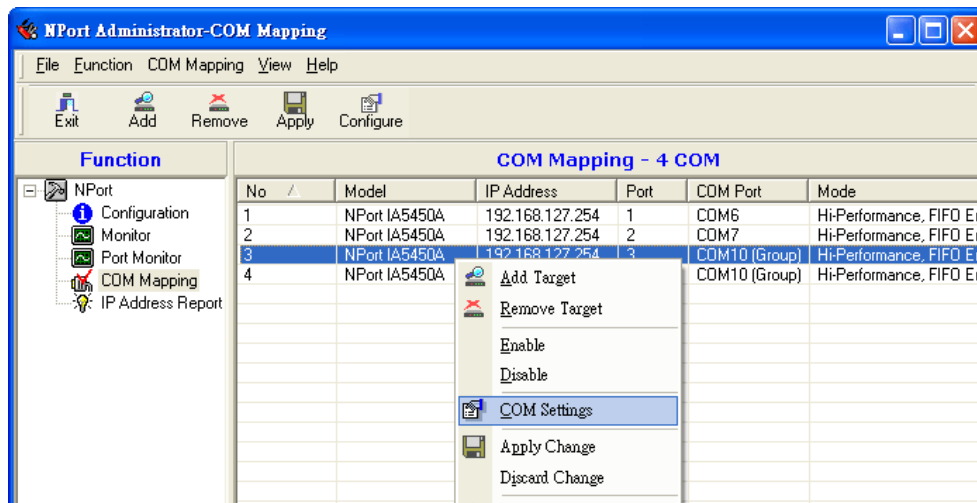

2. Check the **Grouping selected port(s) together** check box.

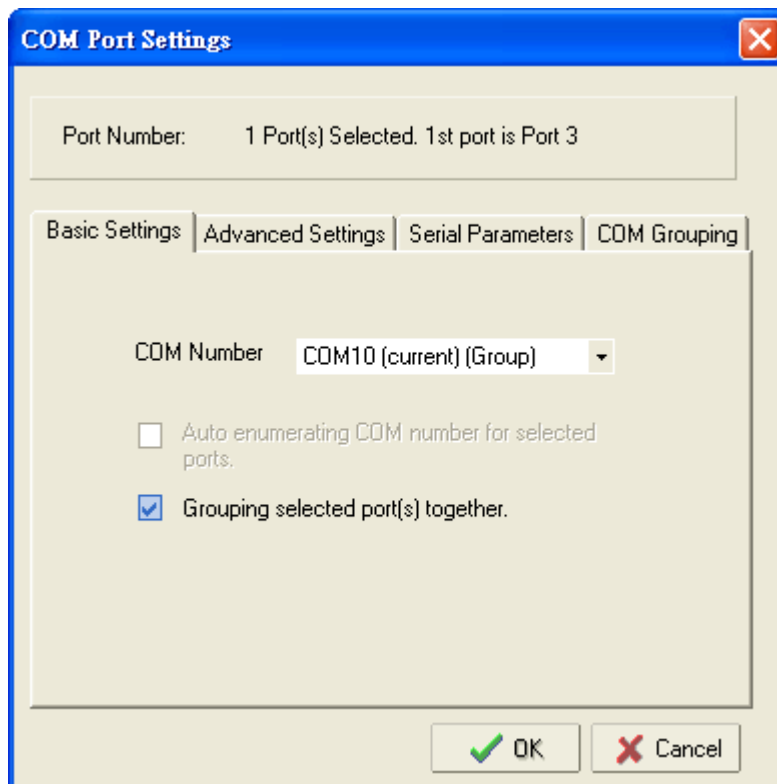

- On **COM Grouping** page, you can specify one serial port whose signals will be taken into account by the COM Group and change the Read/Write status for each serial port.

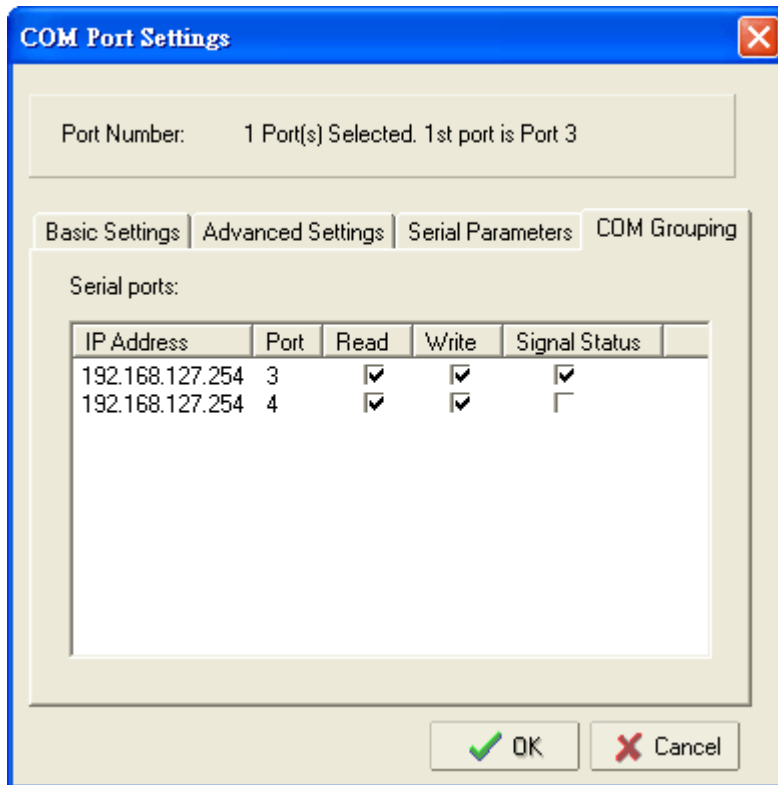

IP Address Report

When the NPort 5000AI-M12 is used in a dynamic IP environment, users must spend more time with IP management tasks. NPort 5000AI-M12 Series products help out by periodically reporting their IP address to the IP location server, in case the dynamic IP has changed.

- Configure the NPort 5000AI-M12 with Dynamic IP settings (DHCP, BOOTP, or DHCP/BOOTP). Assign the remote Auto IP report server's IP address and UDP port.

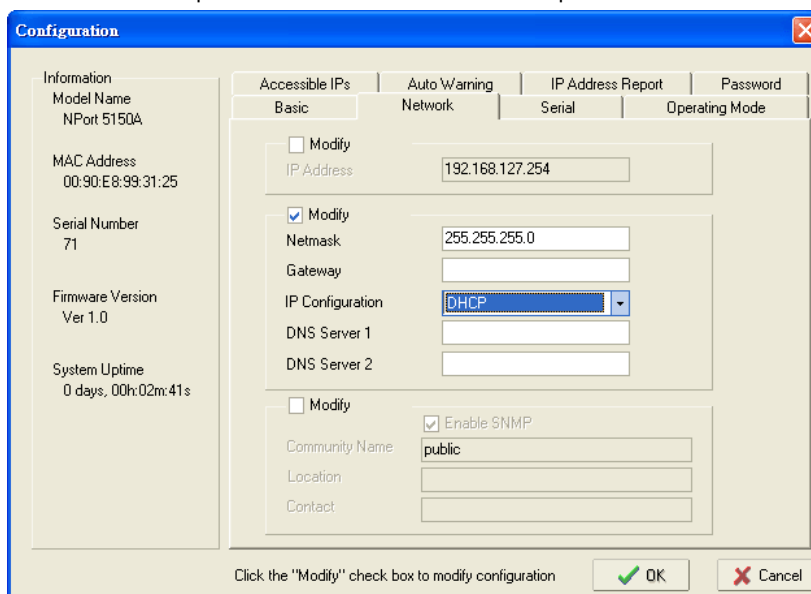

2. Select the **IP Address Report**, and click the right mouse button to select Settings.

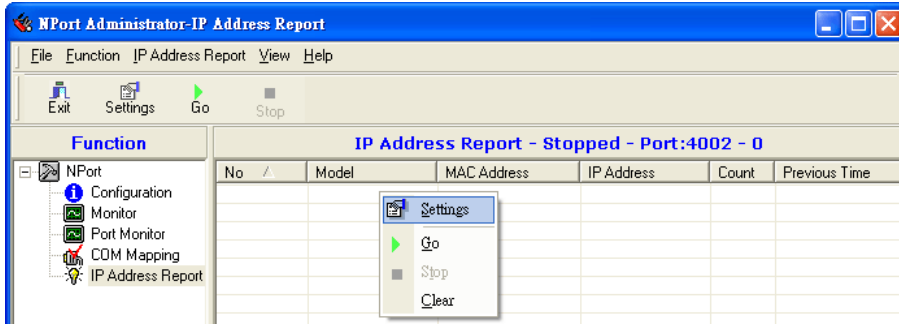

3. Configure the Local Listen Port to be the same as the NPort 5000AI-M12's "Auto report to UDP port" setting.

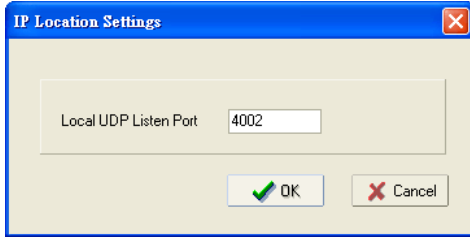

4. Click **Go** to start receiving the Auto IP address report from the NPort 5000AI-M12.

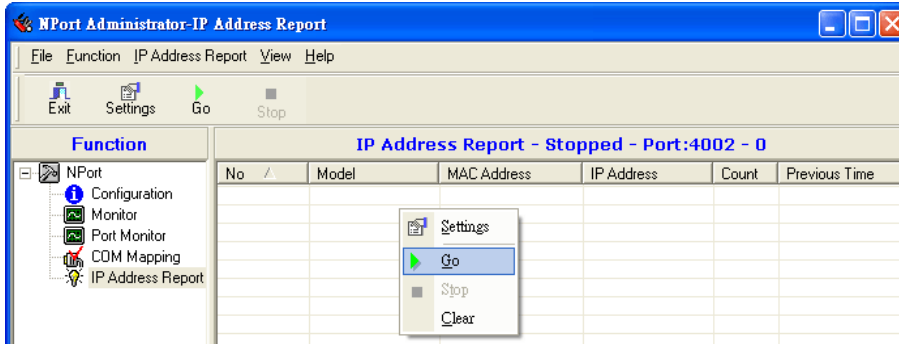

IP Serial Library

The following topics are covered in this chapter:

- **Overview**
- **IP Serial Library Function Groups**
- **Example Program**

Overview

What is IP Serial Library?

IP Serial Library is a Windows library with frequently used serial command sets and subroutines. IP Serial Library is designed to reduce the complexity and poor efficiency of serial communication over TCP/IP. For example, Telnet can only transfer data, but it can't monitor or configure the serial line's parameters.

Why Use IP Serial Library?

For programmers who are familiar with serial communication, IP Serial Library provides well-designed function calls that have the same style as Moxa's PComm Library.

IP Serial Library is amazingly simple and easy to understand. By including it in your VB, C, or Delphi programming environment, you can program your own TCP/IP application with the ability to control serial communication parameters.

NPort 5000AI-M12 serial device servers use 2 TCP ports for communication between the NPort 5000AI-M12 and host computer's Real COM driver. The NPort 5000AI-M12 uses a data port and command port to provide pure data transfer without decode and encode. Compared to using only one TCP port to control serial communication (such as RFC2217), IP Serial Library uses a command port to communicate with the NPort 5000AI-M12 in user's program. IP Serial Library not only runs with excellent efficiency but also runs without any decode or encode problems.

How do I install IP Serial Library?

IP Serial Lib comes with the NPort 5000AI-M12 Administration Suite. Refer to the IP Serial directory for more detail about the function definitions.

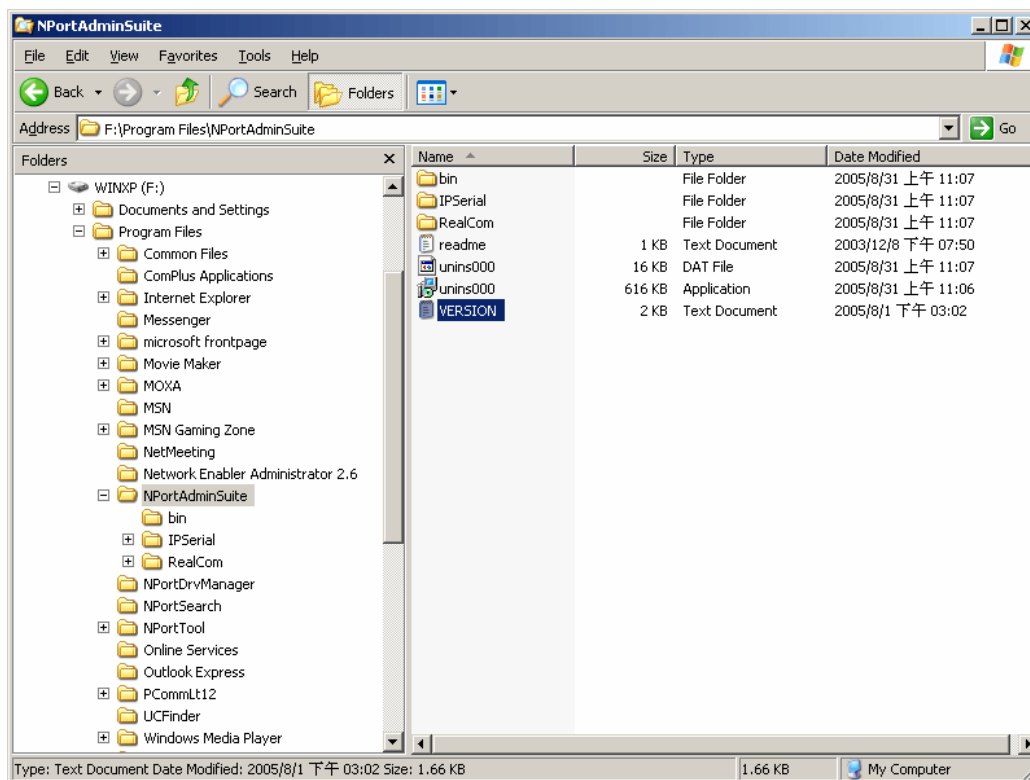

IP Serial Library Function Groups

| Server Control | Port Control | Input/Output Data | Port Status Inquiry | Miscellaneous |
|--|---|--|----------------------------------|--|
| nsio_init nsio_end nsio_resetserver nsio_checkalive | nsio_open nsio_close nsio_ioctl nsio_flowctrl nsio_DTR nsio_RTS nsio_lctrl nsio_baud nsio_resetport | nsio_read nsio_SetReadTimeouts nsio_write nsio_SetWriteTimeouts | nsio_lstatus nsio_data_status | nsio_break nsio_break_on nsio_break_off nsio_breakcount |

Example Program

```

char NPortip="192.168.1.10";
char buffer[255];
int port = 1;
int portid;
nsio_init();
portid = nsio_open(NPortip, port);
nsio_ioctl(portid, B9600, (BIT_8 | STOP_1 | P_NONE ));
sleep(1000);
nsio_read(port, buffer, 200);
nsio_close(portid);
nsio_end();
/*data buffer, 255 chars */
/*1st port */
/* port handle */
/*initial IP Serial Library */
/*1st port, NPort IP=192.168.1.10 */
/*set 9600, N81 */
/* wait for 1000 ms for data */
/* read 200 bytes from port 1 */
/* close this serial port */
/* close IP Serial Library */
    
```

A

Pinouts and Cable Wiring

The following topics are covered in this appendix:

□ **Pin Assignments and Cable Wiring**

- Ethernet M12
- Power M12
- RS-232/422/485 (male DB9) Pinouts

□ **Serial Cable Wiring Diagrams**

- Female DB9 to Male DB9

Pin Assignments and Cable Wiring

Ethernet M12

| PIN | TX |
|-----|-----|
| 1 | TD+ |
| 2 | RD+ |
| 3 | TD- |
| 4 | RD- |



Housing: shield

Power M12

| PIN | Description |
|-----|-----------------|
| 1 | Input V+ |
| 2 | Not assigned |
| 3 | Input V- |
| 4 | Not assigned |
| 5 | Function ground |



RS-232/422/485 (male DB9) Pinouts

| Pin | RS-232 | RS-422, 4-wire RS-485 | 2-wire RS-485 |
|-----|--------|--------------------------|---------------|
| 1 | DCD | TxD-(A) | - |
| 2 | RxD | TxD+(B) | - |
| 3 | TxD | RxD+(B) | Data+(B) |
| 4 | DTR | RxD-(A) | Data-(A) |
| 5 | GND | GND | GND |
| 6 | DSR | - | - |
| 7 | RTS | - | - |
| 8 | CTS | - | - |
| 9 | - | - | - |

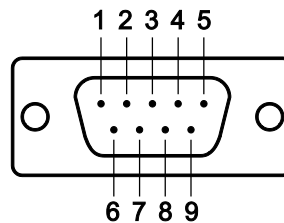

Serial Cable Wiring Diagrams

Female DB9 to Male DB9

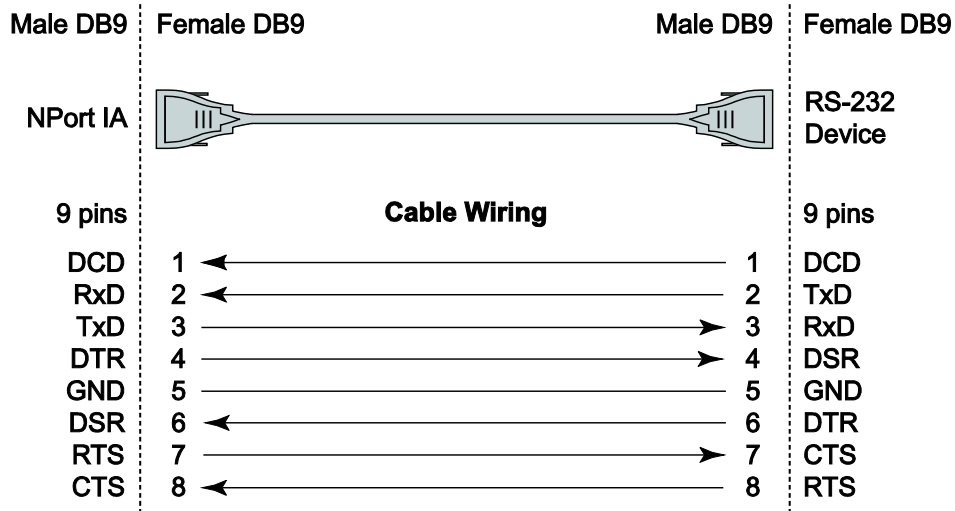

B

Well Known Port Numbers

In this appendix, which is included for your reference, we provide a list of Well Known port numbers that may cause network problems if you set the NPort 5000AI-M12 to one of these ports. Refer to RFC 1700 for Well Known port numbers, or refer to the following introduction from the IANA.

The port numbers are divided into three ranges: the Well Known Ports, the Registered Ports, and the Dynamic and/or Private Ports.

The Well Known Ports are those from 0 through 1023.

The Registered Ports are those from 1024 through 49151.

The Dynamic and/or Private Ports are those from 49152 through 65535.

The Well Known Ports are assigned by the IANA, and on most systems, can only be used by system processes or by programs executed by privileged users. The following table shows famous port numbers among the well-known port numbers. For more details, please visit the IANA website:

<http://www.iana.org/assignments/port-numbers>

| TCP Socket | Application Service |
|------------|---------------------------------------|
| 0 | reserved |
| 1 | TCP Port Service Multiplexor |
| 2 | Management Utility |
| 7 | Echo |
| 9 | Discard |
| 11 | Active Users (sysstat) |
| 13 | Daytime |
| 15 | Netstat |
| 20 | FTP data port |
| 21 | FTP CONTROL port |
| 23 | Telnet |
| 25 | SMTP (Simple Mail Transfer Protocol) |
| 37 | Time (Time Server) |
| 42 | Host name server (names server) |
| 43 | Whois (nickname) |
| 49 | (Login Host Protocol) (Login) |
| 53 | Domain Name Server (domain) |
| 79 | Finger protocol (Finger) |
| 80 | World Wide Web HTTP |
| 119 | Network News Transfer Protocol (NNTP) |
| 123 | Network Time Protocol |
| 213 | IPX |
| 160 to 223 | Reserved for future use |

| UDP Socket | Application Service |
|------------|---------------------------------------|
| 0 | reserved |
| 2 | Management Utility |
| 7 | Echo |
| 9 | Discard |
| 11 | Active Users (systat) |
| 13 | Daytime |
| 35 | Any private printer server |
| 39 | Resource Location Protocol |
| 42 | Host name server (names server) |
| 43 | Whois (nickname) |
| 49 | (Login Host Protocol) (Login) |
| 53 | Domain Name Server (domain) |
| 69 | Trivial Transfer Protocol (TFTP) |
| 70 | Gopher Protocol |
| 79 | Finger Protocol |
| 80 | World Wide Web HTTP |
| 107 | Remote Telnet Service |
| 111 | Sun Remote Procedure Call (Sunrpc) |
| 119 | Network News Transfer Protocol (NNTP) |
| 123 | Network Time Protocol (ntp) |
| 161 | SNMP (Simple Network Mail Protocol) |
| 162 | SNMP Traps |
| 213 | IPX (Used for IP Tunneling) |

SNMP Agents with MIB II & RS-232 Like Groups

NPort 5000AI-M12 has built-in SNMP (Simple Network Management Protocol) agent software. It supports SNMP Trap, RFC1317 RS-232 like group and RFC 1213 MIB-II. The following table lists the standard MIB-II group, as well as the variable implementation for the NPort 5000AI-M12.

RFC1213 MIB-II supported SNMP variables:

| System MIB | Interfaces MIB | IP MIB | ICMP MIB |
|-------------|-------------------|-------------------------|----------------------|
| SysDescr | ifNumber | ipForwarding | IcmpInMsgs |
| SysObjectID | ifIndex | ipDefaultTTL | IcmpInErrors |
| SysUpTime | ifDescr | ipInreceives | IcmpInDestUnreachs |
| SysContact | ifType | ipInHdrErrors | IcmpInTimeExcds |
| SysName | ifMtu | ipInAddrErrors | IcmpInParmProbs |
| SysLocation | ifSpeed | ipForwDatagrams | IcmpInSrcQuenches |
| SysServices | ifPhysAddress | ipInUnknownProtos | IcmpInRedirects |
| | ifAdminStatus | ipInDiscards | IcmpInEchos |
| | ifOperStatus | ipInDelivers | IcmpInEchoReps |
| | ifLastChange | ipOutRequests | IcmpInTimestamps |
| | ifInOctets | ipOutDiscards | IcmpTimestampReps |
| | ifInUcastPkts | ipOutNoRoutes | IcmpInAddrMasks |
| | ifInNUcastPkts | ipReasmTimeout | IcmpOutMsgs |
| | ifInDiscards | ipReasmReqds | IcmpOutErrors |
| | ifInErrors | ipReasmOKs | IcmpOutDestUnreachs |
| | ifInUnknownProtos | ipReasmFails | IcmpOutTimeExcds |
| | ifOutOctets | ipFragOKs | IcmpOutParmProbs |
| | ifOutUcastPkts | ipFragFails | IcmpOutSrcQuenches |
| | ifOutNUcastPkts | ipFragCreates | IcmpOutRedirects |
| | ifOutDiscards | ipAdEntAddr | IcmpOutEchos |
| | ifOutErrors | ipAdEntIfIndex | IcmpOutEchoReps |
| System MIB | Interfaces MIB | IP MIB | ICMP MIB |
| SysServices | ifOutQLen | ipAdEntNetMask | IcmpOutTimestamps |
| | ifSpecific | ipAdEntBcastAddr | IcmpOutTimestampReps |
| | | ipAdEntReasmMaxSize | IcmpOutAddrMasks |
| | | IpNetToMediaIfIndex | IcmpOutAddrMaskReps |
| | | IpNetToMediaPhysAddress | |
| | | IpNetToMediaNetAddress | |
| | | IpNetToMediaType | |
| | | IpRoutingDiscards | |

| UDP MIB | TCP MIB | SNMP MIB |
|-------------------------|---------------------|-------------------------|
| UdpInDatagrams | tcpRtoAlgorithm | snmpInPkts |
| UdpNoPorts | tcpRtoMin | snmpOutPkts |
| UdpInErrors | tcpRtoMax | snmpInBadVersions |
| UdpOutDatagrams | tcpMaxConn | snmpInBadCommunityNames |
| UdpLocalAddress | tcpActiveOpens | snmpInASNParseErrs |
| UdpLocalPort | tcpPassiveOpens | snmpInTooBig |
| | tcpAttemptFails | snmpInNoSuchNames |
| Address Translation MIB | tcpEstabResets | snmpInBadValues |
| AtIfIndex | tcpCurrEstab | snmpInReadOnly |
| AtPhysAddress | tcpInSegs | snmpInGenErrs |
| AtNetAddress | tcpOutSegs | snmpInTotalReqVars |
| Address Translation MIB | TCP MIB | SNMP MIB |
| AtNetAddress | tcpRetransSegs | snmpInTotalSetVars |
| | tcpConnState | snmpInGetRequests |
| | tcpConnLocalAddress | snmpInGetNexts |
| | tcpConnLocalPort | snmpInSetRequests |
| | tcpConnRemAddress | snmpInGetResponses |
| | tcpConnRemPort | snmpInTraps |
| | tcpInErrs | snmpOutTooBig |
| | tcpOutRsts | snmpOutNoSuchNames |
| | | snmpOutBadValues |
| | | snmpOutGenErrs |
| | | snmpOutGetRequests |
| | | snmpOutGetNexts |
| | | snmpOutSetRequests |

| Address Translation MIB | TCP MIB | SNMP MIB |
|-------------------------|---------|-----------------------|
| | | snmpOutGetResponses |
| | | snmpOutTraps |
| | | snmpEnableAuthenTraps |

RFC1317: RS-232 MIB objects

| Generic RS-232-like Group | RS-232-like General Port Table | RS-232-like Asynchronous Port Group |
|---------------------------|--------------------------------|-------------------------------------|
| rs232Number | rs232PortTable | rs232AsyncPortTable |
| | rs232PortEntry | rs232AsyncPortEntry |
| | rs232PortIndex | rs232AsyncPortIndex |
| | rs232PortType | rs232AsyncPortBits |
| | rs232PortInSigNumber | rs232AsyncPortStopBits |
| | rs232PortOutSigNumber | rs232AsyncPortParity |
| | rs232PortInSpeed | |
| | rs232PortOutSpeed | |

| The Input Signal Table | The Output Signal Table |
|------------------------|-------------------------|
| rs232InSigTable | rs232OutSigTable |
| rs232InSigEntry | rs232OutSigEntry |
| rs232InSigPortIndex | rs232OutSigPortIndex |
| rs232InSigName | rs232OutSigName |
| rs232InSigState | rs232OutSigState |

Auto IP Report Protocol

NPort device servers provide several ways to configure Ethernet IP addresses. One of them is DHCP Client. When you set up the NPort to use DHCP Client to configure Ethernet IP addresses, it will automatically send a DHCP request over the Ethernet to find the DHCP Server. And then the DHCP Server will send an available IP address to the NPort. The NPort will use this IP address for a period of time after receiving it. But the NPort will send a DHCP request again to the DHCP Server. Once the DHCP Server realizes that this IP address is to be released to other DHCP Client, the NPort then will receive a different IP address. For this reason, users sometimes find that the NPort will use different IP addresses, not a fixed IP address.

In order to know what IP address the NPort is using, you need to set up parameters in Network Settings via Web browser. The figure below is the NPort Web console configuration window. Enter the IP address and the Port number of the PC that you want to send this information to.

And then you can develop your own programs to receive this information from the NPort. Here is NPort's Auto IP Report Protocol. We provide an example for you to easily develop your own programs. You can find this example on Moxa's website.

Auto IP Report Format

| | | | | |
|-----------------|---------|---------|-----|---------|
| "Moxa", 4 bytes | Info[0] | Info[1] | ... | Info[n] |
|-----------------|---------|---------|-----|---------|

Info [n]

| Field | ID | Length | Data |
|--------|----|--------|------------------------------------|
| Length | 1 | 1 | Variable, Length is "Length Field" |

ID List

| ID Value | Description | Length | Note |
|----------|------------------|----------|--|
| 1 | Server Name | Variable | ASCII char |
| 2 | Hardware ID | 2 | Little-endian |
| 3 | MAC Address | 6 | 6 bytes MAC address. If the MAC address is "00-90-E8-01-02-03", the MAC [0] is 0, MAC[1] is 0x90(hex), MAC[2] is 0xE8(hex), and so on. |
| 4 | Serial Number | 4, DWORD | Little-endian |
| 5 | IP Address | 4, DWORD | Little-endian |
| 6 | Netmask | 4, DWORD | Little-endian |
| 7 | Default Gateway | 4, DWORD | Little-endian |
| 8 | Firmware Version | 4, DWORD | Little-endian Ver1.3.4= 0x0103040 |
| 9 | AP ID | 4, DWORD | Little-endian |

AP ID & Hardware ID Mapping Table

| AP ID | Hardware ID | Product |
|------------|-------------|-------------------|
| 0x80015400 | 0x540A | NPort 5000AI-M12 |
| 0x80015400 | 0x541A | NPort 5000AI-M12I |

Compliance Notice



CE Warning

This is a Class A product. In a domestic environment, this product may cause radio interference in which case the user may be required to take appropriate measures.

Federal Communications Commission Statement

FCC - This device complies with part 15 of the FCC Rules. Operation is subject to the following two conditions: (1) This device may not cause harmful interference, and (2) this device must accept any interference received, including interference that may cause undesired operation.



FCC Warning

This equipment has been tested and found to comply with the limits for a Class A digital device, pursuant to part 15 of the FCC Rules. These limits are designed to provide reasonable protection against harmful interference when the equipment is operated in a commercial environment. This equipment generates, uses, and can radiate radio frequency energy and, if not installed and used in accordance with the instruction manual, may cause harmful interference to radio communications. Operation of this equipment in a residential area is likely to cause harmful interference in which case the user will be required to correct the interference at his own expense.