

NYRIUS®

ARIES™ HOME+ (NAVS502)

INSTRUCTION MANUAL

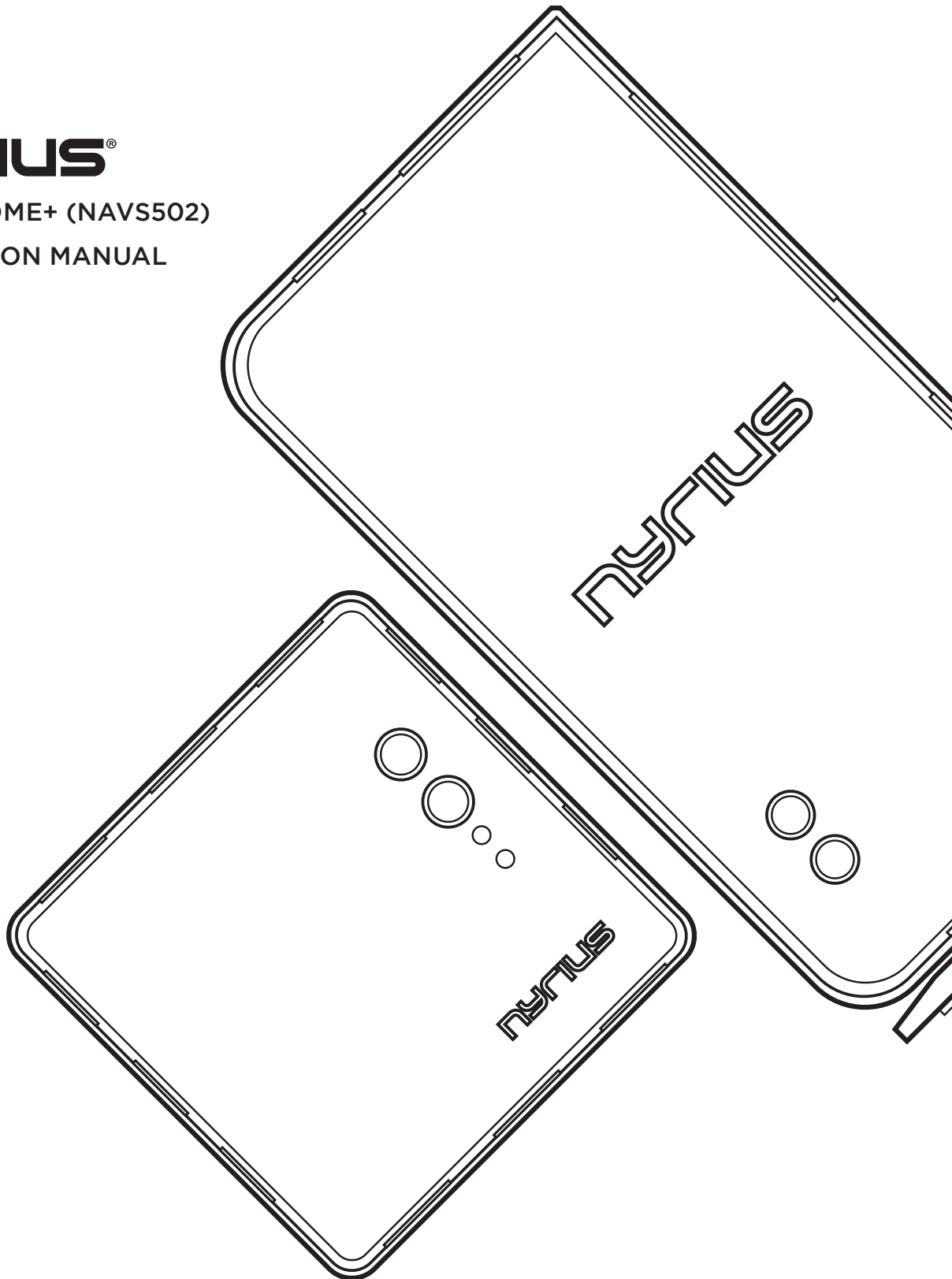

WIRELESS HD TRANSMITTER

CONTENT

- What's Included 3
- Overview..... 3
- Installation..... 5
- LED Description 8
- Mounting 9
- Troubleshooting..... 10
- Audio Bit Rate Support..... 11
- Specification 11
- Supported Resolution..... 12
- FCC/IC Statements 13
- Safety Information..... 14
- Warranty 15

WHAT'S INCLUDED

Remote Control

Transmitter

Receiver

Quick Installation Guide

Mini USB Power Adapter

IR Blaster cable

HDMI cable

Anchors x2

DC Power Adapter

OVERVIEW

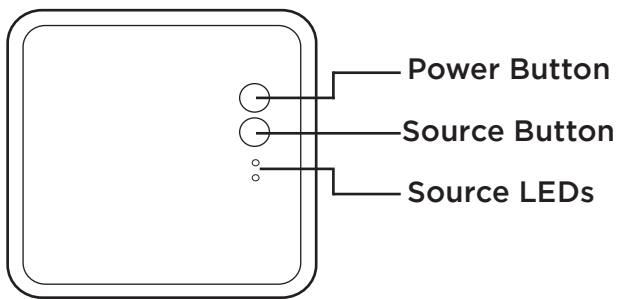

Front Panel Buttons and LEDs

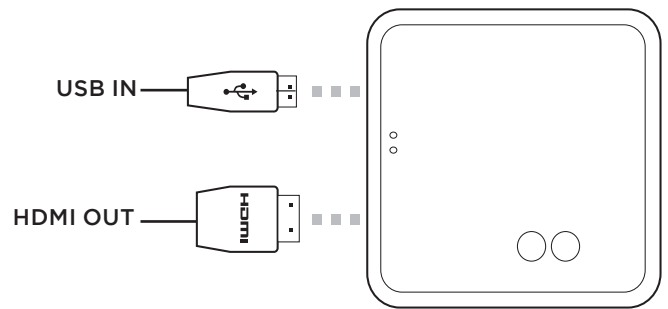

Main Unit Back Panel

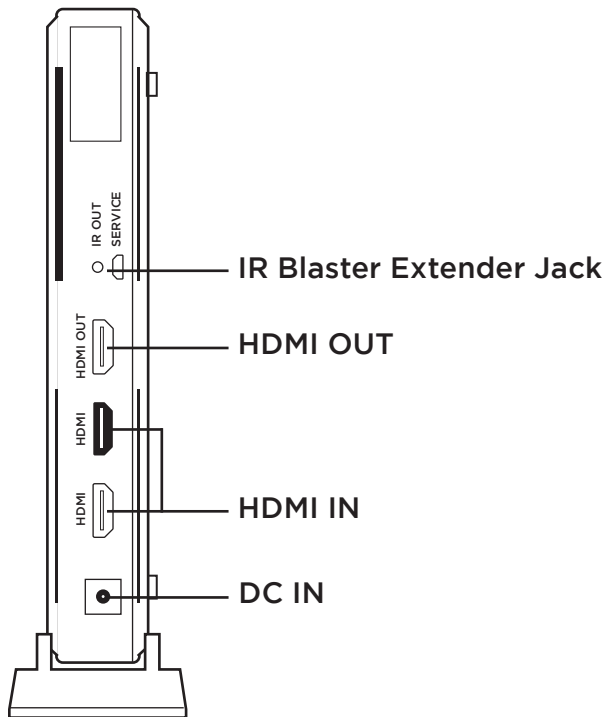

Main Unit Back Panel

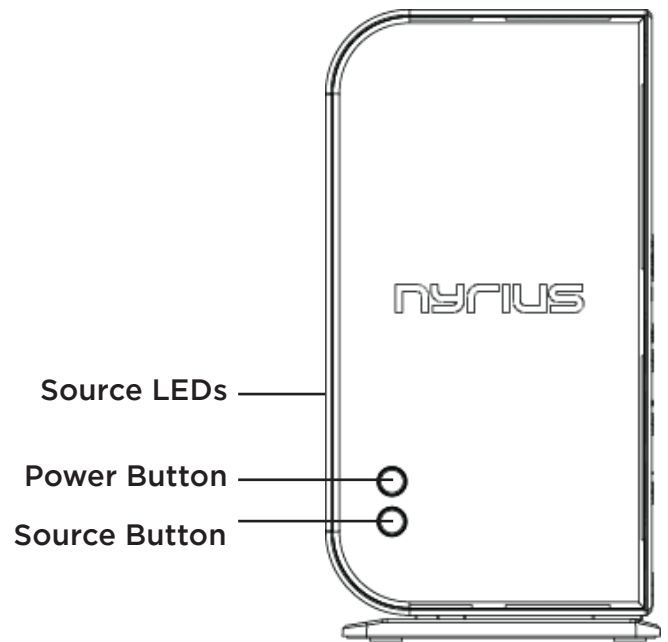

Front Panel Buttons and LEDs

Remote

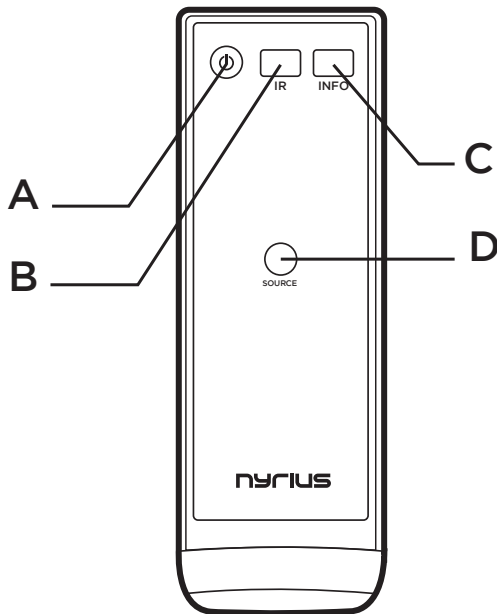

A POWER BUTTON

Press the power button on either the TX or RX to power on both TX and RX automatically

B IR BUTTON

Press to switch the IR Blaster frequency to meet the source device's requirement. It can switch the IR blaster's frequency to 47k/56k/36k respectively.

C INFO. BUTTON

Press this button to display On Screen Display (OSD) for related system information

D SOURCE BUTTON

Press to switch the audio/video sources input connected to transmitter directly.

INSTALLATION

Transmitter

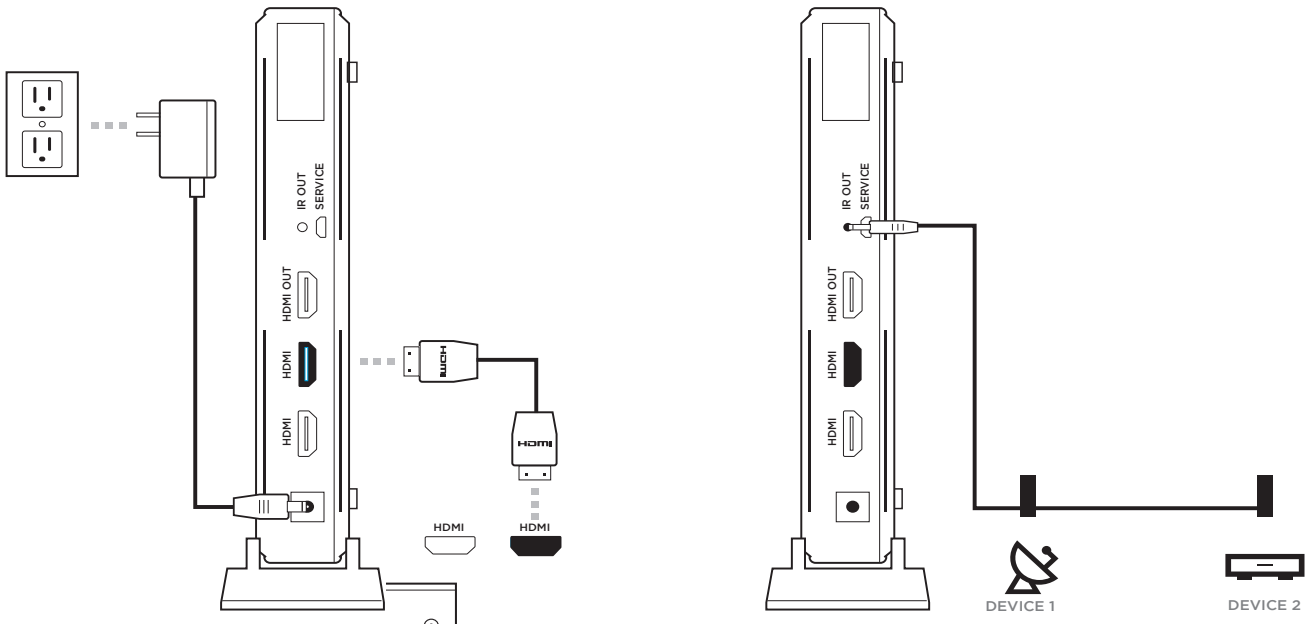

Connect 1 or 2 high-definition audio/video sources to the transmitter

Connect the transmitter's "HDMI OUT" to the HDTV's "HDMI IN" port with an HDMI cable for the loop-through connection (optional).

Connect the supplied power adapter to the DC IN jack of the transmitter and plug into power outlet. The white LED indicator will appear.

RECEIVER

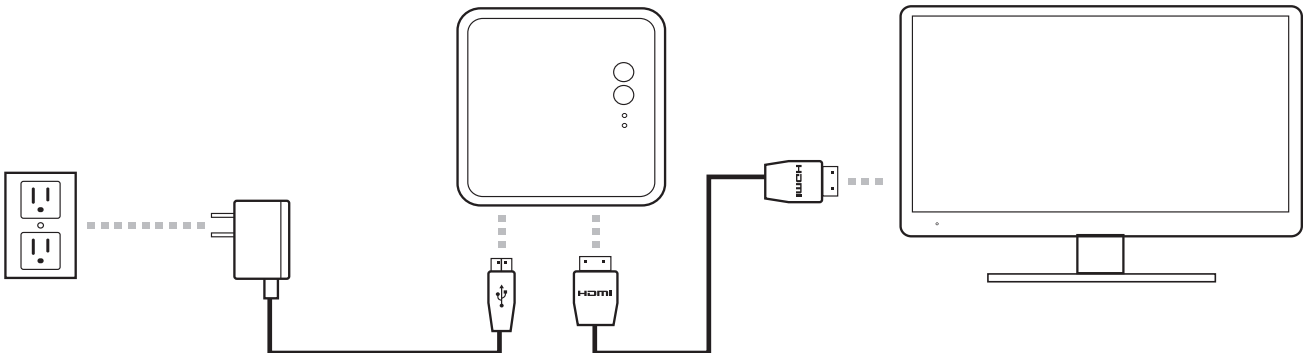

Connect the receiver's "HDMI OUT" to the HDTV's "HDMI IN" port.

Connect the supplied power adapter to the USB Input of the receiver and plug into power outlet.

IR Extender

Plug the external IR remote extender lead into the IR socket on the back of the transmitter

place the IR remote extender bubble in front of the HD device

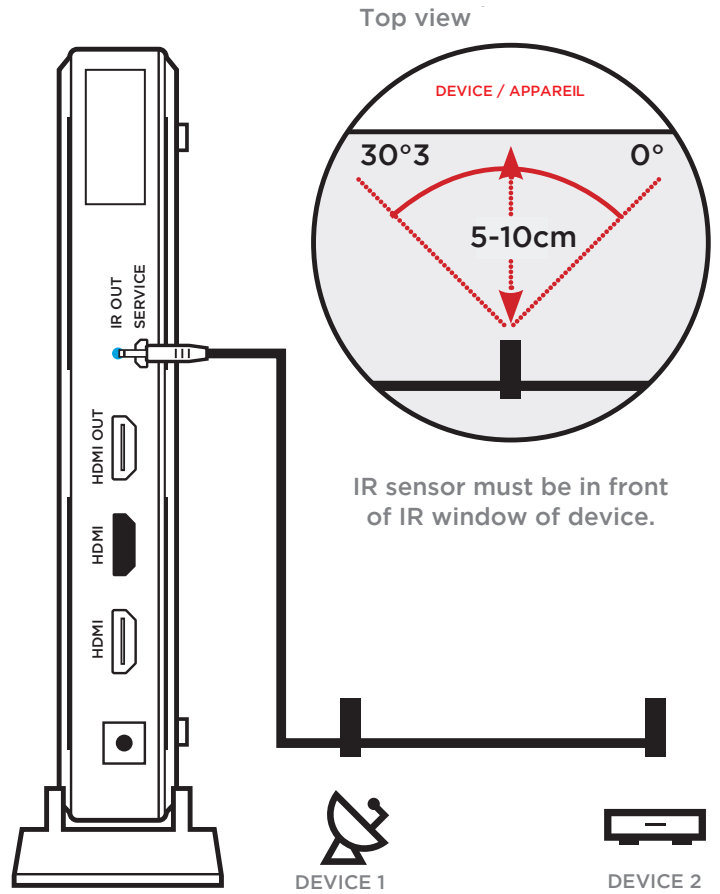

Remote

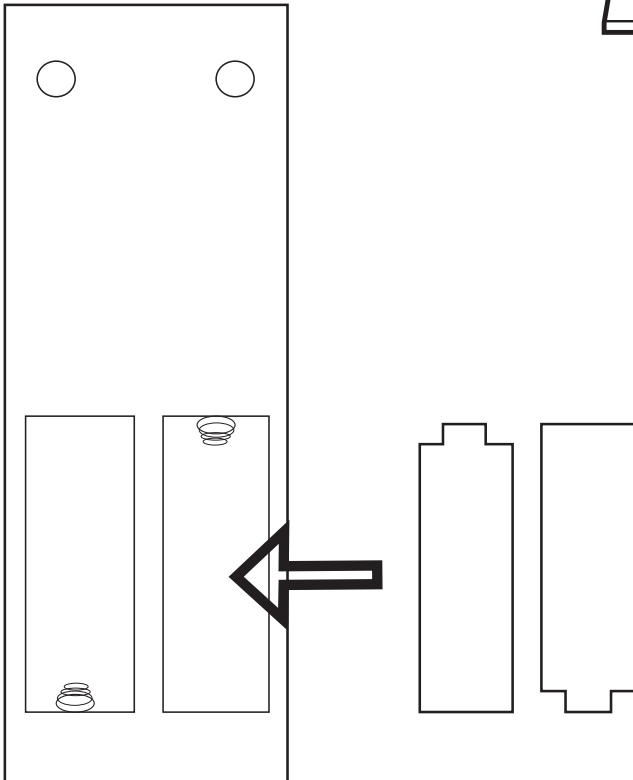

Place the two AAA batteries into the remote control.

Press the Source / Input button of your TV's remote to select the appropriate "HDMI" video input.

POWER

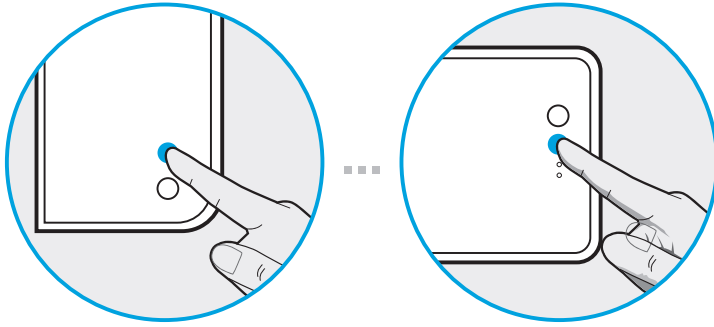

After the power cords are plugged into the power supply, the transmitter and receiver will be turned on automatically. If it is in Standby mode (Both POWER LED of transmitter and receiver are lit in red), press the POWER button either on transmitter or receiver to turn on the transmitter and the receiver.

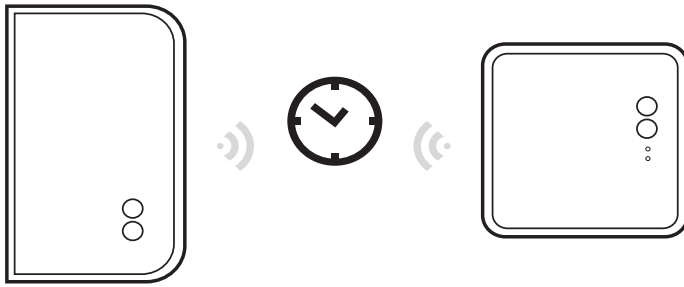

During the warm-up, the POWER LED will blink until connection between the TRANSMITTER and the RECEIVER is established. It will take 15 - 20 seconds for the system boot up successfully.

NOTE: Transmitter's HDMI out will still function in standby mode

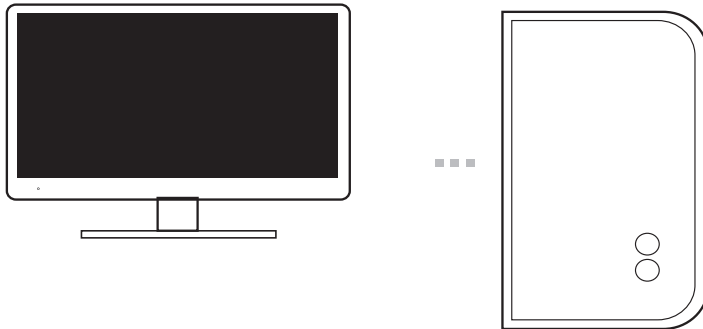

Ensure your TV set or projector is set to the appropriate HDMI source and is powered on.

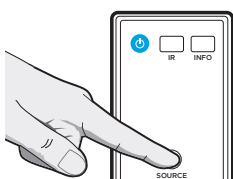

OR
OU

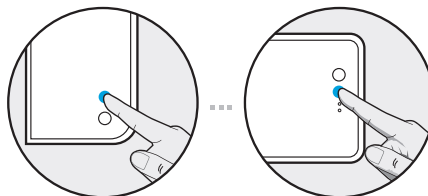

Press the Source button on the transmitter, receiver or remote control to cycle between source inputs.

LED DESCRIPTION













Receiver

Item / Mode	Status Description	Power LED
MODE	POWER LED	SOURCE LED
STANDBY	SOLID RED	OFF
SEARCHING FOR CONNECTION	FLASHING WHITE	FLASHING WHITE

Transmitter

Item / Mode	Status Description	Power LED
MODE	POWER LED	SOURCE LED
STANDBY	SOLID RED	N/A
SEARCHING FOR CONNECTION	FLASHING WHITE	N/A

OSD (On Screen Display) Description

Mode	Status Description	OSD Display (on RX)
Rx: Standby Tx: Active-Standby	Solid RED Power saving mode.	   ON
Pairing	RX searching for unpaired TX	Please Activate Registration on Transmitter Unit
Pairing	RX cannot find new TX	⊗ New WHDI source was not found
Pairing	manually pairing RX and TX	Adding NAVS502/NAVS500 
Waiting for Signal Link	After 80 seconds, can't establish link on any channel.	   ⊗
Linked Mode	No input from selected source	   ⊗
	Video format not recognized	   !
	Video format is recognized	N/A (Audio/Video will display)

INFO KEY (REMOTE CONTROL)

EXAMPLE:

HDMI1(Input Displayed) CH1(Wireless Channel) 1280x1024 (Resolution) = OFF

IR KEY

IR blaster frequency default setting is 47KHz

Press once for current IR frequency status display. Press multiple times to cycle between three frequencies.

The OSD shows: (Display 5secs)

HDMI1 CH1 1280x1024 = 47KHz

Press IR key again to switch IR blaster frequency.

- The OSD shows: (Display 5secs)

HDMI1 CH1 1280x1024 = 56KHz

WALL MOUNTING:

(1) Drill pilot holes.

(2) Insert the supplied two Anchors into the wall.

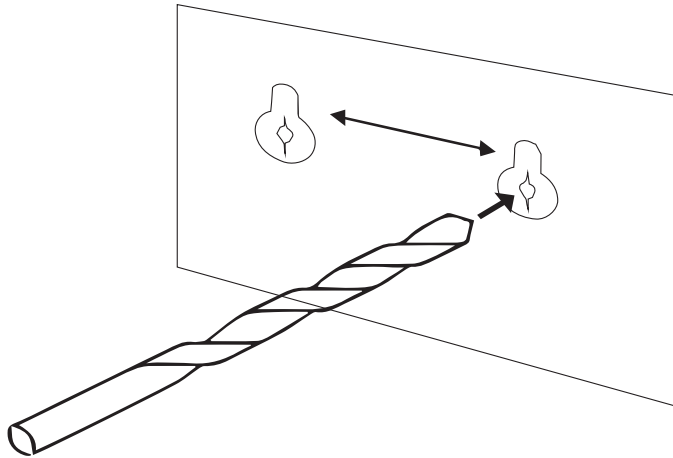

(3) Insert two screws into the anchors. Leave 1/8" length for mounting the Transmitter or receiver.

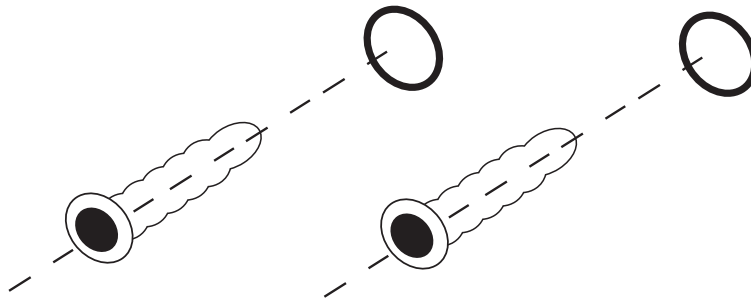

(4) Place NAVS502 main holes over the protruding screws and slide down into position.

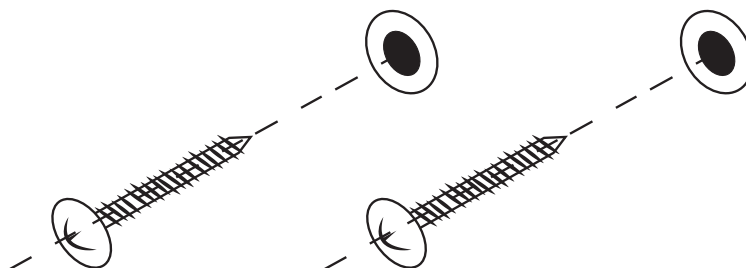

TROUBLESHOOTING:

No Video	<ul style="list-style-type: none"> - Check the status of the Link LEDs, and check if the HD device is working normally. - Check the HDMI lead is undamaged and is plugged into the correct socket. - Check that the correct HDMI output has been selected from the HD device's menu and that the HDMI lead is plugged into the correct output socket. - Check that the correct HDMI input has been selected from the TV menu and that the HDMI lead is plugged into the input socket selected. - Make sure that it is the Receiver that is connected to the HDTV display, and the Transmitter that is connected to your HD device.
Power LED OFF	<ul style="list-style-type: none"> - Make sure the power is connected, and check the power adaptor output 5V/3A DC.
Transmitter Video LED OFF	<ul style="list-style-type: none"> - Check the HD device is powered on. - Make sure the Transmitter is powered on. Make sure the HD device is on, connected to the HDMI socket and outputting a supported resolution (1080p, 1080i, 720p, 720i, 576p, 576i, 480p). - The WHITE LED will switch OFF if an unsupported video signal is output.
Receiver Video LED is ON	<ul style="list-style-type: none"> - Part of the system is not properly connected or the signal received is not of good enough quality/strength. - Make sure the HD display is connected, switched ON and set to the right channel/input (e.g. HDMI channel). - Check the HDMI lead is undamaged and is plugged into the correct socket.
Transmitter / Receiver Link LED Flashes	<ul style="list-style-type: none"> - Make sure the Transmitter and Receiver are not positioned too far apart. Move them closer together to check minimum effective range. - Make sure the HD device is switched ON and had been connected to Transmitter
Bad Picture	<ul style="list-style-type: none"> - Make sure the HDMI leads used are undamaged and that you can get a good picture when the source is connected directly to the display with an HDMI lead. - Make sure nothing is touching or blocking the signal to the built in antennas. - Move Transmitter and Receiver closer together Restart the HD device or reconnect the HDMI lead.
Bad Audio/ No Audio	<ul style="list-style-type: none"> - Make sure that the source is outputting supported audio formats If the audio signal drops out, Restart the audio source and reconnect the HDMI lead Make sure there is no 5.8GHz wireless phone within 50cm of the Receiver. - Some phones use substandard transmission schemes
Other Issues/Unresolved Issues	<ul style="list-style-type: none"> - If any other issue occurs or if the above issues persist, try switching OFF both Transmitter and Receiver and repeating the link set-up process

FAQ

Thank you for your purchase of the Nyrius Aries Home/Home +. If you require any assistance please review the below Frequently Asked Questions.

1. What does the status of the LEDs mean?

SOLID WHITE	LINKED	Transmitter/Receiver is linked.
FLASHING WHITE/BLUE	SEARCHING	Transmitter/Receiver not in range. No HDMI Input connected.
SOLID RED	STANDBY	Transmitter/Receiver in power saving mode.

2. What is the maximum transmission range?

The maximum range is 100 feet line of sight. If transmitting through walls or obstacles the range will be reduced.

3. What steps can I take if the IR Extender is not working?

For proper IR Extender configuration please refer to the included Quick Start Guide. To locate the IR sensor on your device, please contact the manufacturer of your HDMI enabled product. (E.G. Cable box, Blue Ray player, DVD Player). If the issue persists the IR Frequency can be adjusted by pressing IR on the remote control. The available frequencies are 38 KHz, 47 KHz, and 58 KHz.

4. How do I transmit Standard Definition content?

The Aries Home/Home+ cannot transmit 480i resolution. To ensure your standard definition content can be transmitted successfully, ensure your HDMI source and television settings are set to 480p resolution.

5. The Aries Home/Home+ appears warm after prolonged use.

To transmit 3D or Full HD content wirelessly, the Aries Home/Home+ must process a large amount of data. Due to this, the unit may run at warmer temperatures than other electronic devices. We have designed the housing to provide proper ventilation to the unit as well as have designed the electronic components to withstand temperatures up to 80°C. To ensure maximum performance ensure both the Transmitter and Receiver are placed in well ventilated areas that do not exceed 30°C.

6. What are the troubleshooting steps if no video is displayed and the Receiver shows “Searching available channels”? The Transmitter/Receiver may require a few seconds to connect. Ensure the correct HDMI video input is selected on your TV and that your HDMI cables are connected properly. Check that your video resolution from the source device is set to 1080p, 1080i, 720p, 576p, or 480p. Please ensure the Aries Home/Home + is not located near a wireless access point as interference may affect connectivity.

TX/RX WILL NOW BE PAIRED :

1. RX (Receiver) : Remove mini USB power adapter, make sure RX is without power.
2. Press Power button and then plug-in mini USB power adapter. (continue holding power button)
3. Release Power button, RX's Power button LED will now flash purple.

After the 3 steps above , you will see the following OSD :



Please Activate Registration on Transmitter Unit

1. TX (Transmitter): Remove TX 5V DC power adapter, make sure TX is without power.
2. Press Power button and then plug-in 5V DC power adapter. (continue holding power button)
3. Release Power button, RX's Power button LED will now white & Red light.

After the 3 steps above , you will see the following OSD :

NOTE: When pairing NAVS502 you will instead see (Adding NAVS502).

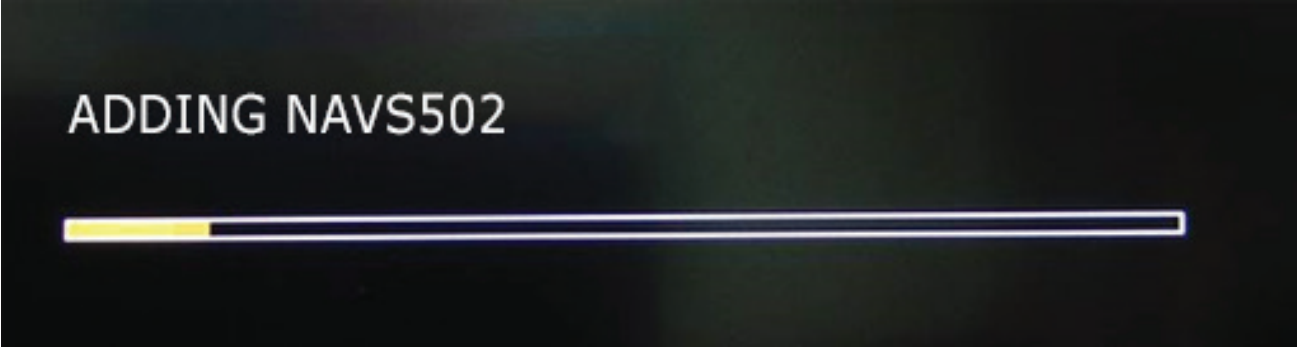

ADDING NAVS502

A progress bar is shown below the text, consisting of a horizontal line with a yellow segment on the left and a white segment on the right.

Units will be paired after the 6 steps are completed.

SUPPORTED RESOLUTIONS:

2D VIDEO FORMAT	RESOLUTION	SUPPORT
640x480p @ 59.94 / 60Hz	480p	YES
720x480p @ 59.94Hz	480p	YES
720x480p @ 60Hz	576p	YES
720x576p @ 50Hz	720p	YES
1280x720p @ 50Hz	720p	YES
1280x720p @ 59.94 / 60Hz	1080i	YES
1920x1080i @ 50Hz	1080i	YES
1920x1080i @ 59.94 / 60Hz	1080p / 60	YES
1920x1080p @ 50Hz	1080p / 60	YES
1920x1080p @ 59.94 / 60Hz	1080p / 24	YES
1920x1080p @ 25Hz	1080p / 24	YES
1920x1080p @ 29.97 / 30Hz	1080p / 24	YES
640x480 @ 59.94 / 72.809Hz	VGA	YES
800x600 @ 60.317 / 72.188Hz	SVGA	YES
1024x768 @ 60 / 70.069Hz	XGA	YES
1280x768 @ 60 Hz	WXGA	YES
1280x1024 @ 60 Hz	SXGA	YES
1600x1200 @ 60Hz	UXGA	YES

3D VIDEO FORMAT	SUPPORT
1280x720p @ 50Hz Top-and-Bottom	YES
1280x720p @ 50Hz Frame packing	YES
1280x720p @ 59.94 / 60Hz Top-and-Bottom	YES
1280x720p @ 59.94 / 60Hz Frame packing	YES
1920x1080i @ 50Hz Side-by-Side (Half)	YES
1920x1080i @ 59.94 / 60Hz Side-by-Side (Half)	YES
1920x1080p @ 23.98 / 24Hz Top-and-Bottom	YES
1920x1080p @ 23.98 / 24Hz Frame packing	YES

AUDIO BIT RATE:

Digital Audio from HDMI inputs: Up to 6Mbit/s bit-rate support. Support AC3 and DTS.
2-channel PCM: 16~24 bits audio sample with 32~96KHz sampling rate as below:

2channel PCM	32KHz	44.1KHz	48KHz	96KHz
16 bits	YES	YES	YES	YES
24 bits	YES	YES	YES	YES

SPECIFICATION:

Supported Video Resolution	1080p, 1080i, 720p, 576p, 480p
3d Compatible	Yes
Wudio Formats	Up to 6 Mbps AC3 and DTS
Ports & Interfaces	Transmitter: 2x HDMI input + 1x HDMI output; Receiver: 1x HDMI output
Wireless Range	100ft (clear line of sight)
Wireless Technology	GigaXtreme Technology
Transmission Frequencies	5.1G ~ 5.9GHz
System Latency	Zero latency (<1ms)
IR Frequency	47K, 58K, 38K
Antenna	High Performance Internal Antennas
Environmental Requirements	Keep a distance of 1.5m with any other wireless product; Any source containing an HDMI port
TV Compatibility	Any high-definition television with HDMI including popular models from these manufacturers: Samsung, Sony, Sharp, Vizio, Hitachi, JVC, LG, Mitsubishi, Panasonic etc.
Wall Mountable	Yes, Transmitter/Receiver have built-in keyhole slots
Remote Control	Yes
Certifications	FCC, ICES, UL
Power Supply	Transmitter: 5V/2A; Receiver: 5V/1.5A
Transmitter Dimensions	7.6x3.8x1.5inches (WxLxH); 192x96.5x31.5mm (WxLxH)
Receiver Dimensions	3.7x3.7x1.2inches (WxLxH); 95x95x-31.5mm (WxLxH)

FCC STATEMENT

This device complies with part 15 of the FCC rules. Operation is subject to the following two conditions:

1. This device may not cause harmful interference, and
2. This device must accept any interference received, including interference that may cause undesired operation.



This class B digital apparatus complies with Canadian ICES-003.

WARNING:

This equipment has been tested and is found to comply with the limits for a Class B digital device, pursuant to Part 15 of the FCC Rules. These limits are designed to provide reasonable protection against harmful interference in a residential installation. This equipment generates, uses and can radiate radio frequency energy and, if not installed and used in accordance with the instructions, may cause harmful interference to radio communications. However, there is no guarantee that interference will not occur in a particular installation. If this equipment does cause harmful interference to radio or television reception, which can be determined by turning the equipment off and on, the user is encouraged to try to correct the interference by one or more of the following measures:

- Reorient or relocate the receiving antenna
- Increase the separation between the equipment and receiver
- Connect the equipment into an outlet on a circuit different from that to which the receiver is connected
- Consult the dealer or an experienced radio/TV technician for help

WARNING:

Changes or modifications not expressly approved by the party responsible for compliance with the FCC Rules could void the user's authority to operate this equipment.

IC STATEMENT

Industry Canada Statement

This device complies with Industry Canada license-exempt RSS standard(s). Operation is subject to the following two conditions:

1. This device may not cause interference, and
2. This device must accept any interference, including interference that may cause undesired operation of the device.

SAFETY INFORMATION

Read all instructions.

Keep these instructions.

Heed all warnings.

Follow all instructions.

Do not use this apparatus near water.

Clean only with a dry cloth.

Do not block any ventilation openings. Install in accordance with the manufacturer's instructions.

Do not install near any heat sources such as radiators, heat registers, stoves, or other apparatus (including amplifiers) that produce heat.

Do not defeat the safety purpose of the polarized or grounding-type plug. A polarized plug has two blades with one wider than the other. A grounding type plug has two blades and a third grounding prong. The wide blade or the third prong are provided for your safety. If the provided plug does not fit into your outlet, consult an electrician for replacement of the obsolete outlet.

Protect the power cord from being walked on or pinched particularly at plugs, convenience receptacles, and the point where they exit from the apparatus.

Only use attachments/accessories specified by the manufacturer.

Unplug this apparatus during lightning storms or when unused for long periods of time.

Refer all servicing to qualified service personnel. Servicing is required when the apparatus has been damaged in any way, such as power-supply cord or plug is damaged. Liquid has been spilled or objects have fallen into the apparatus, the apparatus has been exposed to rain or moisture, does not operate normally, or has been dropped.

Apparatus shall not be exposed to dripping or splashing, and that no objects filled with liquids, such as vases, shall be placed on the apparatus.

The battery shall not be exposed to excessive heat such as sunshine, fire or the like.

The direct plug-in adapter is used as disconnect device, the disconnect device shall remain readily operable.

WARNING: The battery is recyclable. Batteries shall not be exposed to heat such areas.

WARNING: To reduce the risk of fire or electric shock, do not expose this apparatus to rain or moisture.



This marking indicates that this product should not be disposed with other household wastes throughout North America. To prevent possible harm to the environment or human health from uncontrolled waste disposal, recycle it responsibly to promote the sustainable reuse of material resources. To return your used device, please use the return and collection systems or contact the retailer where the product was purchased. They can take this product for environmental safe recycling.

WARRANTY

Thank you for choosing NYRIUS® Consumer Electronics Products!

NYRIUS gives the following express warranty to the original consumer purchaser or gift recipient for this NYRIUS product, when shipped in its original container and sold or distributed by NYRIUS or by an Authorized NYRIUS Dealer: NYRIUS warrants that this product is free, under normal use and maintenance, from any defects in material and workmanship. If any such defects should be found in this product within the applicable warranty period, NYRIUS shall, at its option, repair or replace the product as specified herein. Replacement parts furnished in connection with this warranty shall be warranted for a period equal to the unexpired portion of the original equipment warranty.

This warranty shall not apply to:

- A. Any defects caused or repairs required as a result of abusive operation, negligence, accident, improper installation or inappropriate use as outlined in the owner's manual.
- B. Any NYRIUS product tampered with, modified, adjusted or repaired by any party other than NYRIUS or NYRIUS's Authorized Service Centers.
- C. Damage caused or repairs required as a result of the use with items not specified or approved by NYRIUS including but not limited to head cleaning tapes and chemical cleaning agents.
- D. Any replacement of accessories, glassware, consumable or peripheral items required through normal use of the product including but not limited to earphones, remote controls, AC adapters, batteries, stylus, trays, filters, cables, paper, cabinet, cabinet parts, knobs, buttons, baskets, stands and shelves.
- E. Any cosmetic damage to the surface or exterior that has been defaced or caused by normal wear and tear.
- F. Any damage caused by external or environmental conditions, including but not limited to transmission line/power line voltage or liquid spillage.
- G. Any product received without appropriate model, serial number and CSA /cUL /cULus /cETL /cETLus markings.
- H. Any products used for rental or commercial purposes.
- I. Any installation, setup and/or programming charges.

Should this NYRIUS product fail to operate during the warranty period, warranty service may be obtained upon delivery of the NYRIUS product together with proof of purchase and a copy of this LIMITED WARRANTY statement to an Authorized NYRIUS Service Centre. In-home warranty service may be provided at NYRIUS discretion on any NYRIUS television with the screen size of 40" or larger. This warranty constitutes the entire express warranty granted by NYRIUS and no other dealer, service center or their agent or employee is authorized to extend, enlarge or transfer this warranty on behalf of NYRIUS. To the extent the law permits, NYRIUS disclaims any and all liability for direct or indirect damages or losses or for any incidental, special or consequential damages or loss of profits resulting from a defect in material or workmanship relating to the product, including damages for the loss of time or use of this NYRIUS product or the loss of information. The purchaser will be responsible for any removal, re-installation, transportation and insurance costs incurred. Correction of defects, in the manner and period of time described herein, constitute complete fulfillment of all obligations and responsibilities of NYRIUS Electronics to the purchaser with respect to the product and shall constitute full satisfaction of all claims, whether based on contract, negligence, strict liability or otherwise.

1 YEAR PARTS & LABOUR WARRANTY PERIOD

To obtain the name and address of the nearest authorized NYRIUS service center or for more information on this warranty contact NYRIUS support:

NYRIUS Customer Service
4080 Montrose Road, Niagara Falls, ON. L2H 1J9

nyrius.com/support

Nyrius is a registered trade-mark of Circus World Displays Limited