

# Robustel GoRugged M1000 MP

Smart Cellular Modem

For GPRS/EDGE/UMTS/HSPA+ Networks

## User Guide

Document Name: **User Guide**  
Date: **2015-10-07**  
Status: **Confidential**  
Doc ID: **RT\_UG\_M1000 MP\_v.1.2.2**



***Robustel***

[www.robustel.com](http://www.robustel.com)

## About This Document

This document describes the hardware and software of the *Robustel GoRugged M1000 MP Smart Cellular Modem*.

**Copyright© Guangzhou Robustel Technologies Co., Limited  
All Rights Reserved.**

## Trademarks and Permissions

Robustel are trademark of Guangzhou Robustel Technologies Co., Limited.

All other trademarks and trade names mentioned in this document are the property of their respective holders.

## Disclaimer

No part of this document may be reproduced in any form without the written permission of the copyright owner. The contents of this document are subject to revision without notice due to continued progress in methodology, design and manufacturing. Robustel shall have no liability for any error or damage of any kind resulting from the use of this document.

## Technical Support Contact Information

Tel: +86-20-23354618

Fax: +86-20-82321505

E-mail: [support@robustel.com](mailto:support@robustel.com)

Web: [www.robustel.com](http://www.robustel.com)

## Important Notice

Due to the nature of wireless communications, transmission and reception of data can never be guaranteed. Data may be delayed, corrupted (i.e., have errors) or be totally lost. Although significant delays or losses of data are rare when wireless devices such as the modem is used in a normal manner with a well-constructed network, the modem should not be used in situations where failure to transmit or receive data could result in damage of any kind to the user or any other party, including but not limited to personal injury, death, or loss of property. Robustel accepts no responsibility for damages of any kind resulting from delays or errors in data transmitted or received using the modem, or for failure of the modem to transmit or receive such data.

## Safety Precautions

### General

- The modem generates radio frequency (RF) power. When using the modem, care must be taken on safety issues related to RF interference as well as regulations of RF equipment.
- Do not use your modem in aircraft, hospitals, petrol stations or in places where using CELLULAR products is prohibited.
- Be sure that the modem will not be interfering with nearby equipment. For example: pacemakers or medical equipment. The antenna of the modem should be away from computers, office equipment, home appliance, etc.
- An external antenna must be connected to the modem for proper operation. Only uses approved antenna with the modem. Please contact authorized distributor on finding an approved antenna.
- Always keep the antenna with minimum safety distance of 20 cm or more from human body. Do not put the antenna inside metallic box, containers, etc.

**Note:** *Some airlines may permit the use of cellular phones while the aircraft is on the ground and the door is open. Modem may be used at this time.*

### Using the modem in vehicle

- Check for any regulation or law authorizing the use of cellular devices in vehicle in your country before installing the modem.
- The driver or operator of any vehicle should not operate the modem while driving.
- Install the modem by qualified personnel. Consult your vehicle distributor for any possible interference of electronic parts by the modem.
- The modem should be connected to the vehicle's supply system by using a fuse-protected terminal in the vehicle's fuse box.
- Be careful when the modem is powered by the vehicle's main battery. The battery may be drained after extended period.



### Protecting your modem

- To ensure error-free usage, please install and operate your modem with care. Do remember the following:
- Do not expose the modem to extreme conditions such as high humidity / rain, high temperature, direct sunlight, caustic / harsh chemicals, dust, or water.
- Do not try to disassemble or modify the modem. There is no user serviceable part inside and the warranty would be void.

- Do not drop, hit or shake the modem. Do not use the modem under extreme vibrating conditions.
- Do not pull the antenna or power supply cable. Attach/detach by holding the connector.
- Connect the modem only according to the instruction manual. Failure to do it will void the warranty.
- In case of problem, please contact authorized distributor.

## Regulatory and Type Approval Information

**Table 1:** Directives

2011/65/EC	Directive 2011/65/EU of the European Parliament and of the Council of 8 June 2011 on the restriction of the use of certain hazardous substances in electrical and electronic equipment (RoHS)	
2012/19/EU	Directive 2012/19/EU the European Parliament and of the Council of 4 July 2012 on waste electrical and electronic equipment (WEEE)	

**Table 2:** Standards of the Ministry of Information Industry of the People’s Republic of China

SJ/T 11363-2006	“Requirements for Concentration Limits for Certain Hazardous Substances in Electronic Information Products” (2006-06).	
SJ/T 11364-2006	<p>“Marking for Control of Pollution Caused by Electronic Information Products” (2006-06).</p> <p>According to the “Chinese Administration on the Control of Pollution caused by Electronic Information Products” (ACPEIP) the EPUP, i.e., Environmental Protection Use Period, of this product is 20 years as per the symbol shown here, unless otherwise marked. The EPUP is valid only as long as the product is operated within the operating limits described in the Hardware Interface Description.</p> <p>Please see <a href="#">Table 3</a> for an overview of toxic or hazardous substances or elements that might be contained in product parts in concentrations above the limits defined by SJ/T 11363-2006.</p>	

**Table 3:** Toxic or hazardous substances or elements with defined concentration limits

Name of the part	Hazardous substances					
	(Pb)	(Hg)	(Cd)	(Cr (VI) )	(PBB)	(PBDE)
Metal Parts	o	o	o	o	o	o
Circuit Modules	x	o	o	o	o	o
Cables and Cable Assemblies	o	o	o	o	o	o
Plastic and Polymeric parts	o	o	o	o	o	o

o:  
Indicates that this toxic or hazardous substance contained in all of the homogeneous materials for this part is below the limit requirement in SJ/T11363-2006.

x:  
Indicates that this toxic or hazardous substance contained in at least one of the homogeneous materials for this part *might exceed* the limit requirement in SJ/T11363-2006.

**Revision History**

Updates between document versions are cumulative. Therefore, the latest document version contains all updates made to previous versions.

Release Date	Doc Version	Details
2013-12-18	V1.0.0	First Release
2015-01-04	V1.1.0	Update Section: Packing List, Install SIM Card, Power Supply
2015-03-19	V1.2.0	Update Section: LED Indicator, device pictures, Packing List, Safety Precautions, Regulatory and Type Approval Information, mount the modem, PIN assignment, file format
2015-05-13	V1.2.1	Update section: picture(single antenna), LED Indicator, Regulatory and Type Approval Information
2015-10-07	V1.2.2	Update Section: Cover Image, packing list, Specification(antenna)

## Contents

Chapter 1	Product Concept.....	7
1.1	Overview .....	7
1.2	Packing List.....	7
1.3	Specifications .....	9
1.4	Dimensions.....	10
1.5	Selection and Ordering Data .....	11
Chapter 2	Installation.....	12
2.1	Overview .....	12
2.2	LED Indicator .....	12
2.3	PIN assignment .....	13
2.4	USB interface.....	13
2.5	Install SIM Card .....	13
2.6	Connect the External Antenna (SMA Type) .....	14
2.7	Connect the Modem to External Device.....	15
2.8	Mount the Modem .....	15
2.9	Power Supply .....	16
Chapter 3	Operate the Modem .....	18
3.1	AT Command Set.....	18
3.1.1	Start SecureCRT .....	18
3.1.2	AT Commands Examples.....	20
3.2	CSD Connection.....	20
3.2.1	Overview.....	20
3.2.2	Establishing a CSD Connection .....	21
3.2.3	Answering a CSD Connection .....	22
3.3	Using Short Message Service .....	23
3.3.1	Sending a Short Message.....	23
3.3.2	Reading a Short Message .....	23
3.3.3	Deleting a Short Message.....	24
3.4	GPRS Connection .....	25
3.4.1	Overview.....	25
3.4.2	Windows GPRS Access.....	25
Chapter 4	Appendix .....	38
4.1	GSM Alphabet .....	38
4.2	Troubleshooting .....	41
4.2.1	The modem's LED does not light: .....	41
4.2.2	The modem keep rebooting all the time:.....	42
4.2.3	No connection with modem through serial link.....	42
4.2.4	Receiving "No Carrier" Message .....	42
4.3	Terms and Abbreviations .....	43

# Chapter 1 Product Concept

## 1.1 Overview

Robustel GoRugged M1000 MP is a compact design cellular modem with serial/USB port and plastic housing, offering state-of-the-art 2G/3G connectivity for machine to machine (M2M) applications.

- Control via AT commands (Hayes 3GPP TS 27.007 and 27.005).
- TCP/IP, SMS, CSD access via AT commands.
- 1 serial port and 1 mini USB 2.0 high speed interface.
- Wide range input voltages and extreme operating temperature.
- The plastic enclosure can be mounted on a DIN-rail or on the wall, also with extra ground screw.

## 1.2 Packing List

Check your package to make certain it contains the following items:

- Robustel GoRugged M1000 MP modem x1

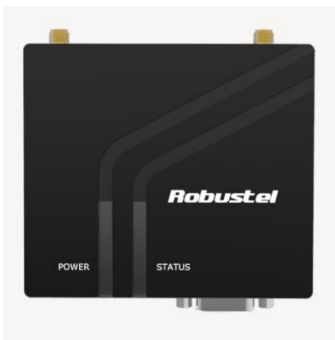

**Two antennas**

or



**One antenna**

- 3.5mm 2-pin pluggable terminal block for power connector x1



- CD with user guide x1

**Note:** Please notify your sales representative if any of the above items are missing or damaged.

Optional accessories (can be purchased separately):



- SMA antenna (Stubby antenna or Magnet antenna optional)  
The number of SMA antenna depend on the model of M1000 MP, more details please refer to **1.3 Specifications** section.



***Stubby antenna***



***Magnet antenna***

- Serial cable for RS232 (DB9 Female to DB9 Male, 1 meter) x1



- Mini USB cable x1



- Wall Mounting Kit



- 35mm Din-Rail mounting kit



- AC/DC Power Supply Adapter (12VDC, 1A) x1



- DB9 Male to terminal block for serial port  
The detail about the PIN assignment is showed in the 2.3 PIN assignment section.

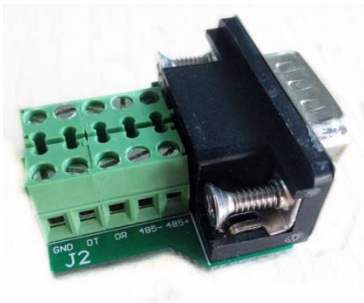

## 1.3 Specifications

### Cellular Interface

- Standards: GSM/GPRS/EDGE/UMTS/HSDPA/HSPA+
- GPRS: max. 86 kbps (DL & UL), class 10
- EDGE: max. 236.8 kbps (DL & UL), class 12
- UMTS: max. 384 kbps (DL & UL)
- HSDPA: max. 3.6 Mbps/384 kbps (DL/UL)
- HSPA+: max. 14.4/5.76 Mbps (DL/UL)
- Frequency: 850/900/1800/1900 MHz for GPRS/EDGE, 900/2100 MHz or 850/900/1900/2100 MHz for UMTS/HSDPA/HSPA+
- CSD: Up to 9.6 kbps
- SIM: 1 x (3V & 1.8V)
- Antenna Interface: SMA Female

Cellular interface	the number of antenna interface
2G GSM	1
3G HSDPA	1
3G HSPA+	2
4G LTE	2

### Serial Interface

- Number of Ports: 1 x DB9 Female

- Serial Standards: RS232 or RS485
- ESD Protection:  $\pm 15\text{KV}$
- Parameters: 1200bps to 115200bps
- RS-232: DCD, RxD, TxD, DTR, GND, DSR, RTS, CTS, RI
- RS-485: Data+ (A), Data- (B)

#### USB Interface

- Number of Ports: 1 x mini USB Female
- Speed: USB 2.0 High Speed (480 Mbit/s)
- ESD Protection: 15KV

#### System

- LED Indicators: RUN

#### Power Supply and Consumption

- Power Supply Interface: 2-pin 3.5mm pluggable terminal block
- Input Voltage: 6 to 18 VDC (2G model)  
6 to 26 VDC (3G model)
- Power Consumption: Idle: 50-60 mA@12 V  
Data Link: 100 to 200 mA (peak)@12 V

#### Physical Characteristics

- Housing & Weight: Plastic, 105g
- Dimension(L x W x H): 75 x 85 x 28 mm
- Installation: 35mm Din-Rail or wall mounting or desktop

## 1.4 Dimensions

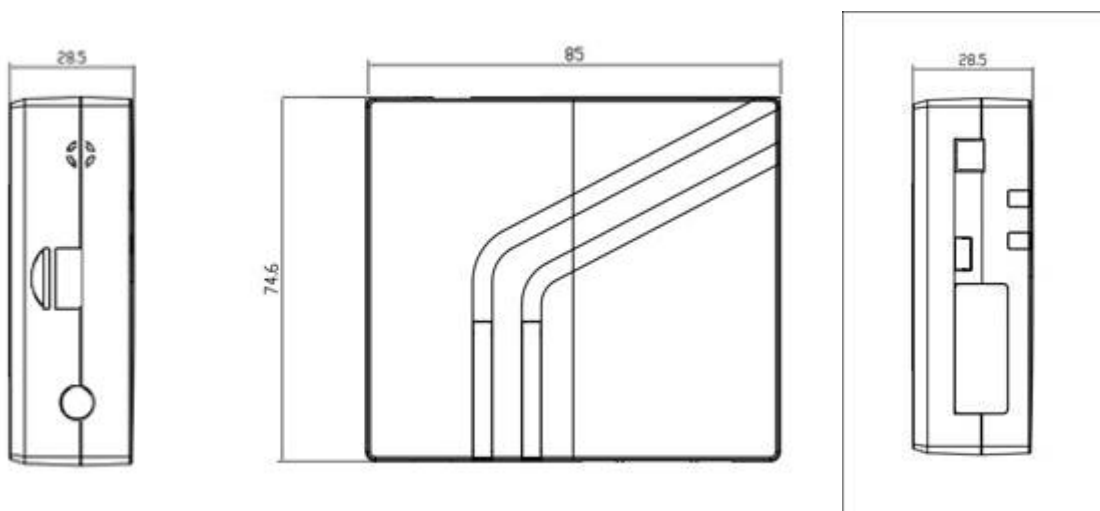

## 1.5 Selection and Ordering Data

Model No.	Description	Operating Environment	Input Voltage
M1000-MP2GA	1 port RS232, GSM/GPRS 850/900/1800/1900 MHz	-40 to 85°C/5 to 95% RH	6 to 18 VDC
M1000-MP2GB	1 port RS485, GSM/GPRS 850/900/1800/1900 MHz	-40 to 85°C/5 to 95% RH	6 to 18 VDC
M1000-MP3HA	1 port RS232, 1 mini USB port, UMTS/HSDPA 900/2100 MHz, Quad band GSM/GPRS/EDGE	-40 to 85°C/5 to 95% RH	6 to 26 VDC
M1000-MP3PA	1 port RS232, 1 mini USB port, UMTS/HSPA+ 850/900/1900/2100 MHz, Quad band GSM/GPRS/EDGE	-40 to 85°C/5 to 95% RH	6 to 26 VDC

# Chapter 2 Installation

## 2.1 Overview

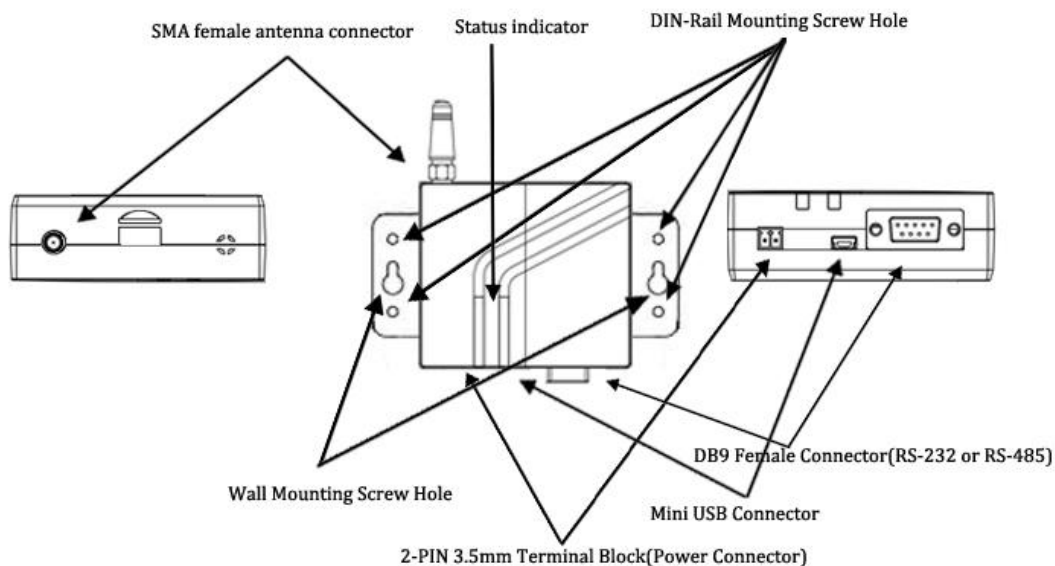

## 2.2 LED Indicator



Name	Color	Status	Description
RUN	Green	On	M1000 MP is powered up.
		Off	M1000 MP is powered off.
Status	Green	On(dual antennas only) / Blinking quickly(single antenna only)	The current network is connected. <i>Note: only effective on 3G module, if some 3G modules don't support the LED, the LED won't light.</i>
		Blink every 3 second	The current network is disconnected. <i>Note: only effective on 3G module, if some 3G modules don't support the LED, the LED won't light.</i>

	Off	The current module is 2G. The LED will never light.
--	-----	---

### 2.3 PIN assignment

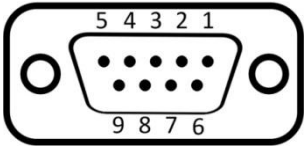

Terminal block

PIN	RS232	RS485 (2-wire)	Terminal block	Direction
1	DCD	Data+ (A)	485+	M1000 MP → Device
2	RXD		RXD	M1000 MP → Device
3	TXD		TXD	Device → M1000 MP
4	DTR		DT	Device → M1000 MP
5	GND		GND x2	
6	DSR	Data- (B)	485-	M1000 MP → Device
7	RTS		RTS	Device → M1000 MP
8	CTS		CTS	M1000 MP → Device
9	RI		DR	M1000 MP → Device

### 2.4 USB interface

USB interface can be used for sending/receiving data and power supply. When USB interface of M1000 MP is used for sending/receiving data as well as power supply, current/voltage output of USB interface which connects to M1000 MP's USB interface shall at least reach to **1A/5V**.

*Note: Normally, current/voltage output of PC's USB 2.0 interface is only 0.5A/5V. So when you use USB interface for sending/receiving data, you should use power input interface for power supply (for details please refer to section **2.8 Power Supply**).*

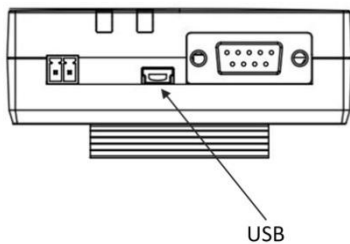

### 2.5 Install SIM Card

Be sure to insert a SIM card before you use the modem.

**Note:** A SIM card set with PIN code cannot be used normally in the modem without the correct PIN code.

Make sure to disconnect the adapter and switch off your modem before inserting or removing your SIM/USIM card.



- **Inserting SIM Card**

1. Make sure your adapter is disconnected.
2. Insert the SIM card, and you need press the SIM card with your fingers until you hear “a cracking sound”.

- **Removing SIM card**

1. Make sure your adapter is disconnected.
2. Press the SIM card until you hear “a cracking sound”, then the SIM card will pop up to be pulled out.

**Note:**

1. Don't touch the metal surface of the SIM card in case information in the card is lost or destroyed.
2. Don't bend or scratch your SIM card. Keep the card away from electricity and magnetism.
3. Make sure to disconnect the power source from your modem before inserting and removing your SIM card.



4. Please use the specific M2M SIM card when the device works in extreme temperature (temperature exceeding 0-40 °C), because the long-time working of regular SIM card in harsh environment (temperature exceeding 0-40 °C) may increase the possibility of SIM card failure.

## 2.6 Connect the External Antenna (SMA Type)

Connect this to an external antenna with SMA male connector. Make sure the antenna is within correct frequency range as your mobile operator with impedance of 50ohm, and connector is secured tightly.

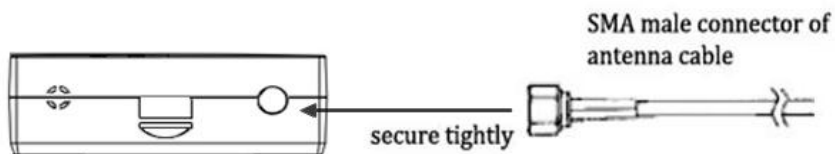

## 2.7 Connect the Modem to External Device

User can use the serial cable to connect the modem's DB9 female connector to external controller / computer.

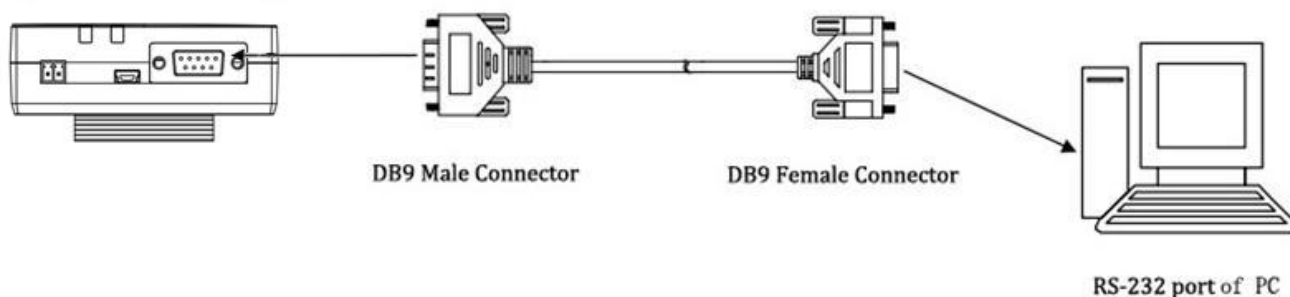

User can use the USB cable to connect the modem's Mini USB Connector to external controller / computer.

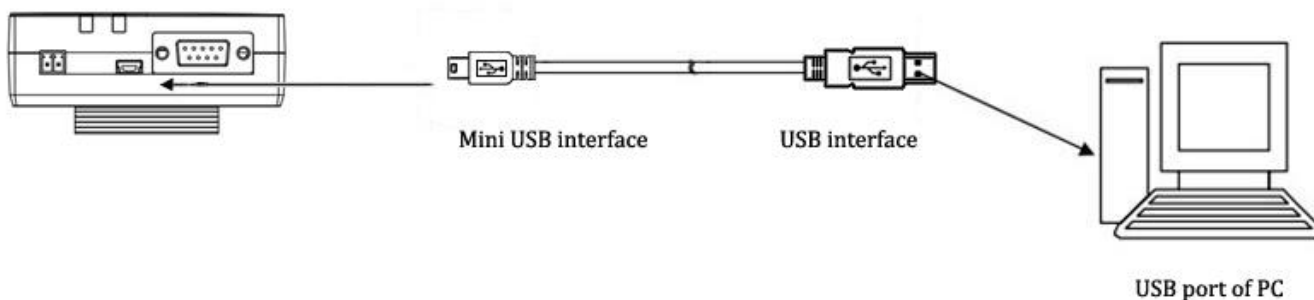

## 2.8 Mount the Modem

- **Two ways of mounting the modem**

1. Use 3 pcs of M3 screw to mount the Modem on the Wall mounting Kit.  
And then use 2 pcs of M3 screw to mount the Wall mounting Kit on the wall.





2. Mount the modem on a DIN rail with 3 pcs of M3 screws, and then hang the DIN-Rail on the holder. You need to choose a standard holder.

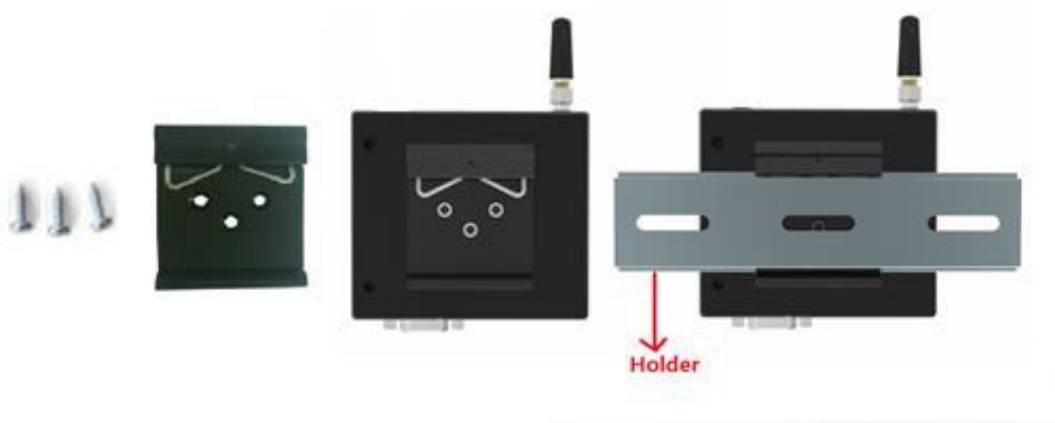

## 2.9 Power Supply

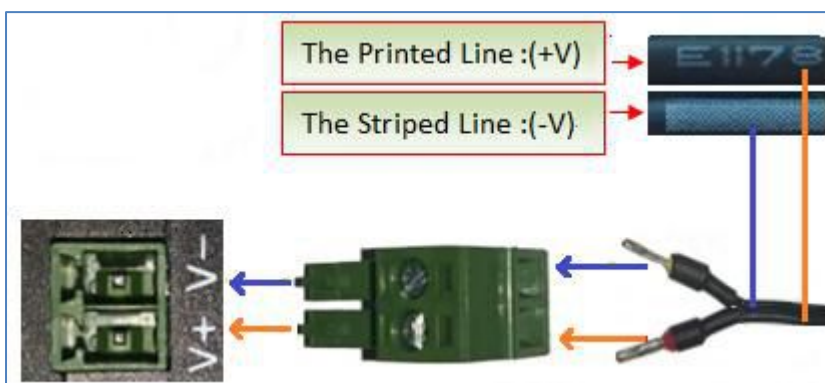

The power supply range is 6 to 18 VDC (2G model) or 6 to 26 VDC (3G model).

**Note:** Please take care about the polarity, and do not make reverse connection. There are two lines connecting to the

*power supply adapter, as it illustrates on the power supply adapter label, the line printed with letters needs to be connected with the positive polarity, and the striped line needs to be connected with the negative polarity.*

## Chapter 3 Operate the Modem

We can operate and configure M1000 MP via AT commands through mini USB port or serial port. This chapter will introduce mainly AT commands examples while configuring M1000 MP.

### 3.1 AT Command Set

M1000 MP supports the guidelines known as the “AT Command Set.” AT Command Set is the industry standard line-oriented command language used to communicate with the modem.

**Note:** You can enter AT commands to configure M1000 MP from serial software such as secureCRT which you can download via: <https://app.box.com/s/arkn6xk1asqs1myvuue>.

#### 3.1.1 Start SecureCRT

1. Double click SecureCRT Potable.exe .



2. File->Connect->New Session

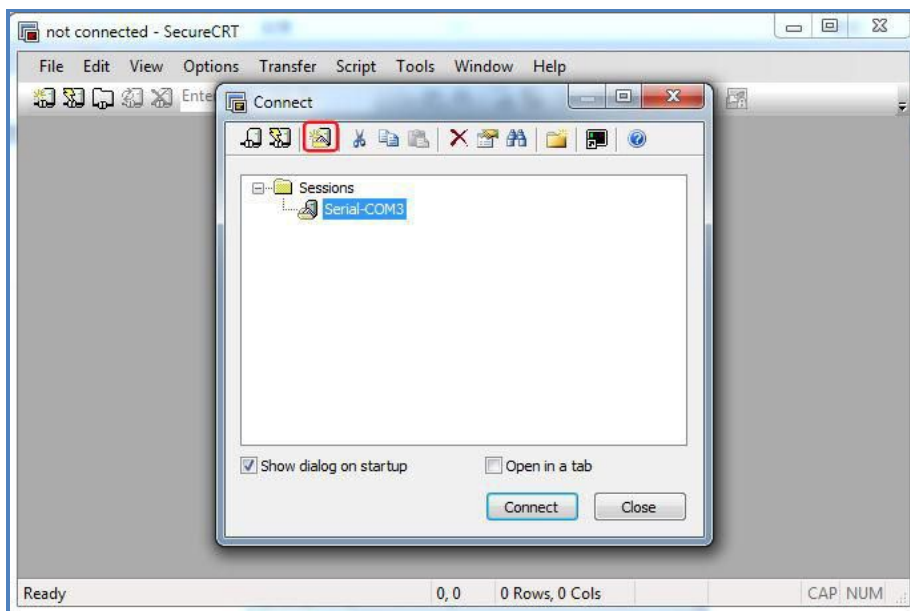

3. Select Protocol as "Serial".

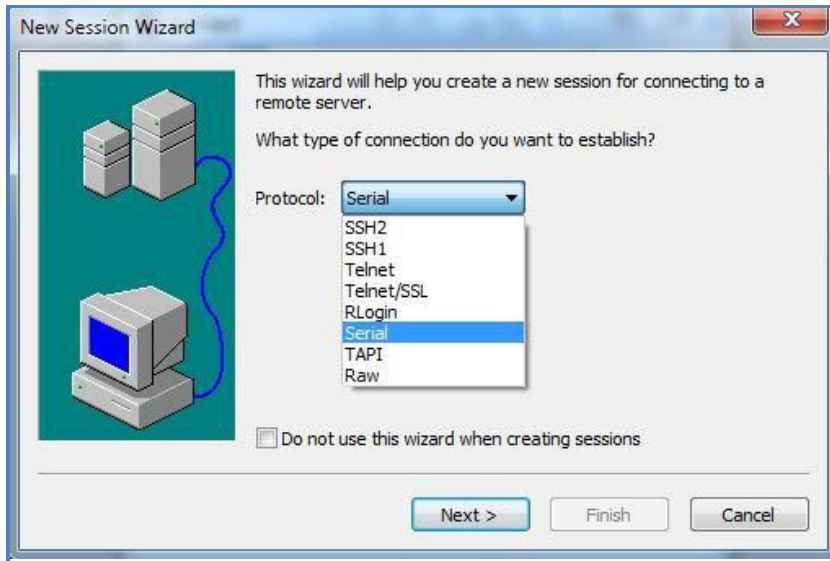

4. Select relevant COM port and match the parameters as below, click the "Next" button to finish this session.  
**Note:** you need to match the serial parameters as: 115200,8,n,1, and disable "RTS/CTS".

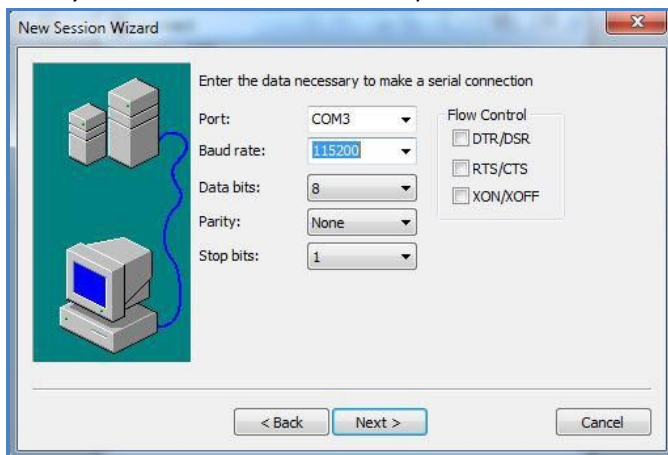

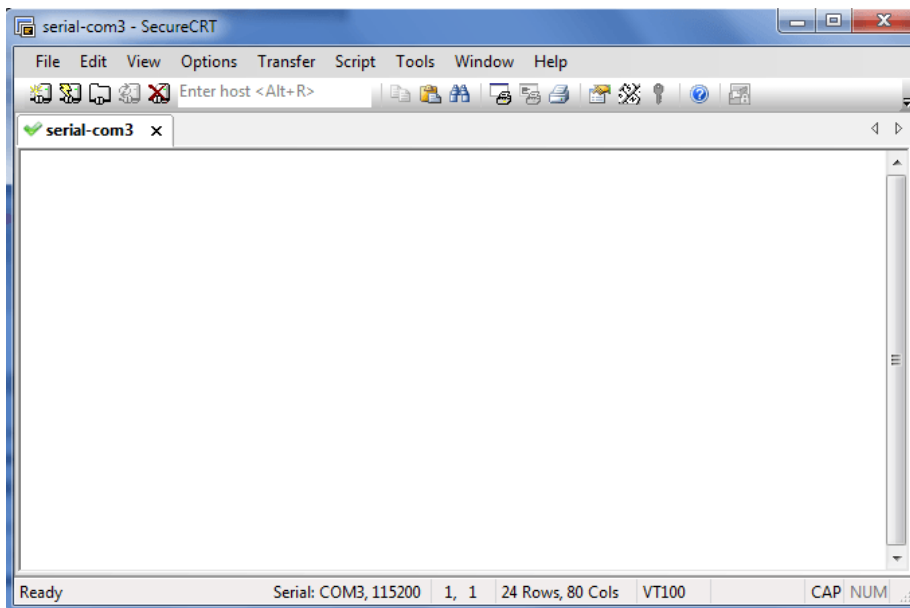

### 3.1.2 AT Commands Examples

Followings are examples of some AT commands. Please refer to the AT command guide for a full description.

Description	AT commands	Modem response	Comments
Modem acknowledgement	AT	OK	Responding OK indicates that the modem is ready.
Receiving signal strength	AT+CSQ	+CSQ: 19,99	The first parameter has to be at least 15 for normal communication.
Query current PIN status	AT+CPIN?	+CPIN: READY	SIM card is correctly inserted and modem is not pending for any password
		+CPIN: SIM PIN	PIN1 is required
		+CPIN: SIM PUK	PUK1 is required
Saves parameters in non-volatile memory	AT&W	OK	The configuration settings are stored.

## 3.2 CSD Connection

### 3.2.1 Overview

A Circuit-Switched Data Connection makes the wireless modem work in a manner similar to a regular analog modem. CSD (Circuit Switched Data) is the original form of data transmission developed for cellular systems. By using a single radio time slot, CSD is able to deliver 9.6 to 14.4 kbit/s data transmission to both the Cellular Network and PSTN Switching Subsystem through direct calls. Most of the time, it is initiated by standard AT commands. Using the modem to access remote devices by CSD is often more convenient than installing cables and data lines. Data

collection and monitoring will be more flexible since CSD can be used for applications that are hard to wire or hard to access.

**Note:** Ensure that your SIM card has the CSD Service activated. For most regions, you must apply to your mobile service provider to receive this service.

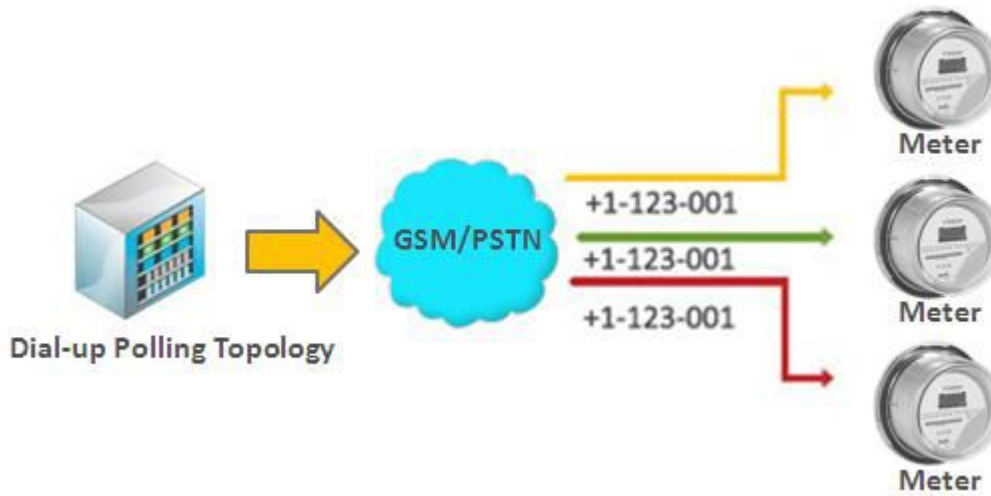

### 3.2.2 Establishing a CSD Connection

1. Start SecureCRT with default serial parameters 115200,8,n,1.
2. Type **ATD <phone number>** and press **Enter** to establish a CSD connection. (e.g. ATD 123456, in which 123456 is the phone number.)
3. After remote side answering the CSD call, then the CSD connection has been established successfully.
4. To close the CSD connection, type **+++**. The modem will respond with OK to indicate that you have already switched back to the command mode. It means you can enter AT commands again via SecureCRT.
5. Type **ATH** and press **Enter** to disconnect.

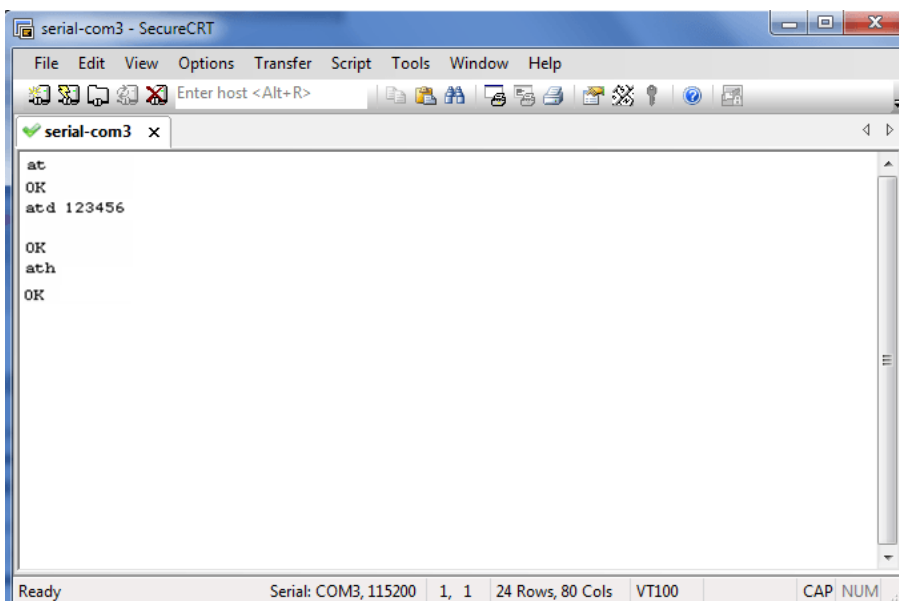

**Note:**

- *+++ is the escape sequence, and ATH is the hang-up command.*
- *For international calls, the local international prefix does not need to be set, but does need to be replaced by the + character. E.g., you would type **ATD+86123456**, in which +86 is the country code.*

### 3.2.3 Answering a CSD Connection

1. When secureCRT displays the RING response, type **ATA**, and press **Enter**.

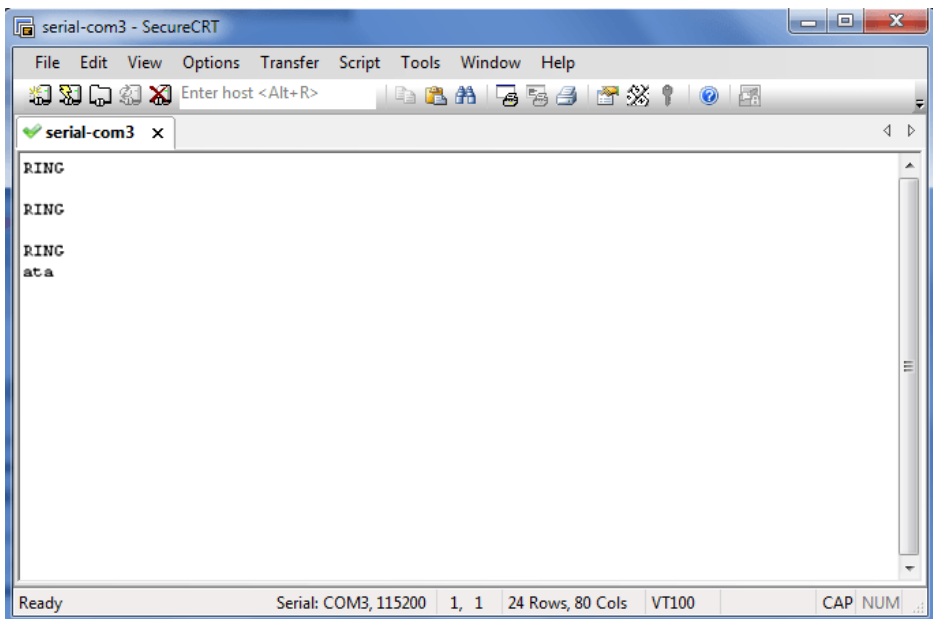

2. In the secureCRT window, type **ATS0=x** and press Enter. For **x**, substitute the number of rings that the modem should receive before answering the call. For example, to answer after the first ring, type **ATS0=1**.
3. Type **AT&W** and press Enter.

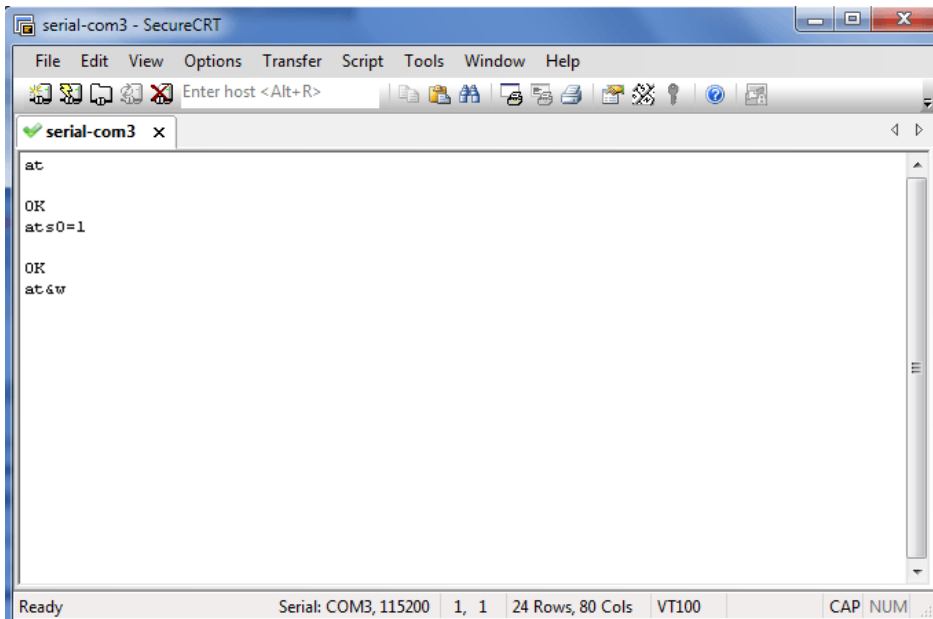

4. To close the CSD connection, type **+++**. The modem will respond with OK to indicate that you have already switched back to the command mode.
5. Type **ATH** and press Enter to disconnect.

### 3.3 Using Short Message Service

Cellular technology offers the benefit of using SMS (short message service) as an easy way to communicate over the mobile network.

The following topics are covered in this chapter:

1. Sending a Short Message
2. Reading a Short Message
3. Deleting a Short Message

#### 3.3.1 Sending a Short Message

1. Type **AT+CMGF=1** and press **Enter**.
2. Type **AT+CMGS="<phone number>"** and press **Enter**. The terminal will automatically move to the next line, which starts with **>**. Type your message on the right of the **>**.
3. Enter **Ctrl + Z** deliver the message.

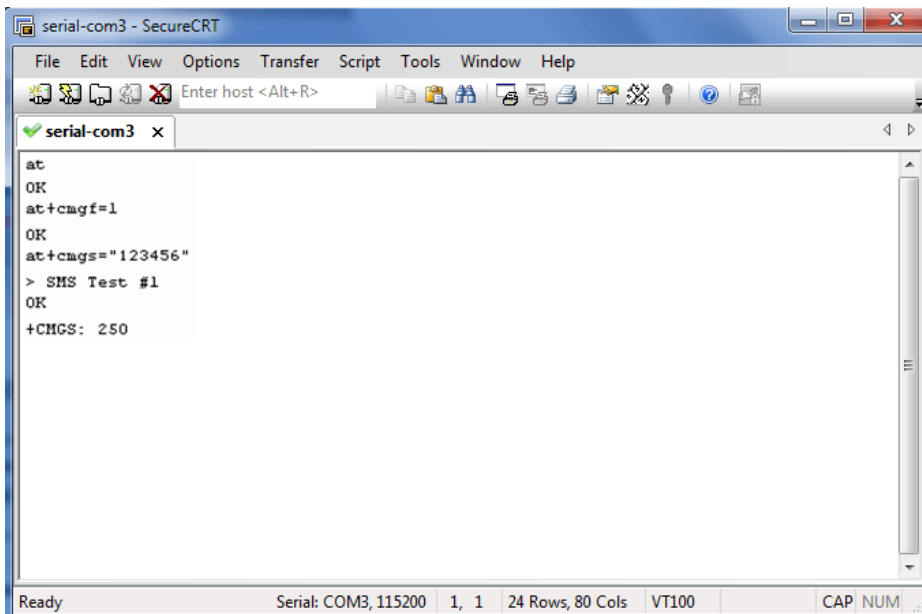

```
serial-com3 - SecureCRT
File Edit View Options Transfer Script Tools Window Help
Enter host <Alt+R>
serial-com3 x
at
OK
at+cmgf=1
OK
at+cmgs="123456"
> SMS Test #1
OK
+CHGS: 250
Ready Serial: COM3, 115200 1, 1 24 Rows, 80 Cols VT100 CAP NUM
```

**Note:** **AT+CMGF=1** sets the SMS to Text mode.

#### 3.3.2 Reading a Short Message

1. Type **AT+CMGF=1** and then press **Enter**.
2. Type **AT+CNMI=2,1** and then press **Enter**.
3. When a short message is received, the modem will show the storage number of the message after **+CMIT: "SM"**,



$x$ " (where the  $x$  is the storage number).

4. Type **AT+CMGR= $x$**  to read the message.
5. In the example shown below, the  $x=5$  means that the message is stored in the 5th storage location.

```

serial-com3 - SecureCRT
File Edit View Options Transfer Script Tools Window Help
Enter host <Alt+R>
serial-com3 x
at
OK
+CMTI: "SM",5
at+cmgr=5
+CMGR: "REC UNREAD", "+886972613404", "07/03/19,00:36:24+32"
SMS Test #1
OK
Ready Serial: COM3, 115200 1, 1 24 Rows, 80 Cols VT100 CAP NUM

```

### 3.3.3 Deleting a Short Message

Type **AT+CMGD= $x,n$**  and then press **Enter**.

This is where  $x$  represents one of the following options:

- “**REC UNREAD**” Shows received unread messages.
- “**REC READ**” Shows received read messages.
- “**STO UNSENT**” Shows stored unsent messages.
- “**STO SENT**” Shows stored sent messages.
- “**ALL**” Shows messages.

This is where  $n$  represents one of the following options:

- 0** Delete message at location <include the index number>
- 1** Delete all READ messages.
- 2** Delete all READ and SENT messages.
- 3** Delete all READ, SENT, and UNSENT messages.
- 4** Delete ALL messages. “**REC UNREAD**” Shows received unread messages.

**Note:** Refer to the Documentation and Software CD / AT\_Commands / AT\_Commands.pdf for further detail commands information using SMS.

## 3.4 GPRS Connection

### 3.4.1 Overview

GPRS is a packet-switched technology, which means that multiple users share the same transmission channel. In addition, GPRS transmits only when there is outgoing data. This means that the available bandwidth can be dedicated solely to data communication when needed. In general, a GPRS network can be viewed as a special IP network that offers IP connectivity to IP terminals. Devices such as PCs, embedded computers, and PLCs that are PPP-enabled can be easily connected to the IP network and the Internet.



### 3.4.2 Windows GPRS Access

The modem can use Windows DUN (Dial-up Networking) to provide the Internet access through the GPRS mobile network. Instructions are described in the following chapters.

**Note:** *The specific steps may vary depending on your version of Windows and your Windows settings. Following steps are basing on Windows 7.*

- **Change baudrate of modem**

1. Confirm modem's baudrate is set as 115200,8,n,1.

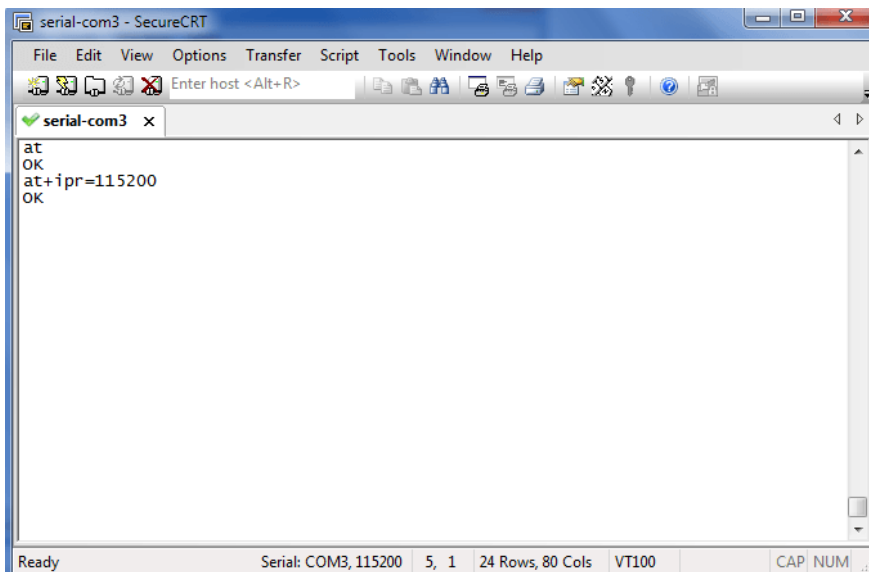

- **Installing the Modem Driver**

1. In the Control Panel, open “**Phone and Modem**” Options and click the “**Modem**” tab. Click **Add** to add a new modem.

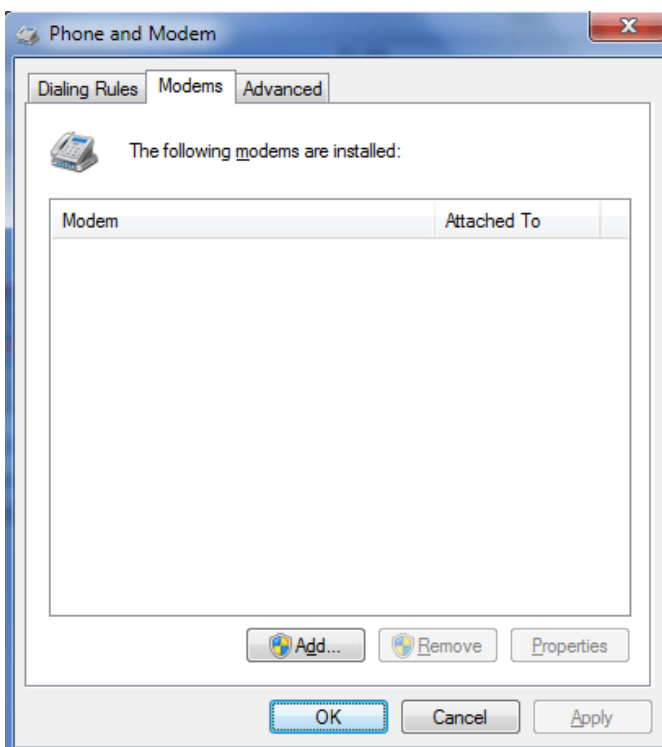

**Note:** The first time you access the **Phone and Modem** Options, Windows will ask you to input the area code. Enter the area code to proceed.

2. When the Install Mode window opens, select **Don't detect my modem, I will select it from a list** and then click **Next**.

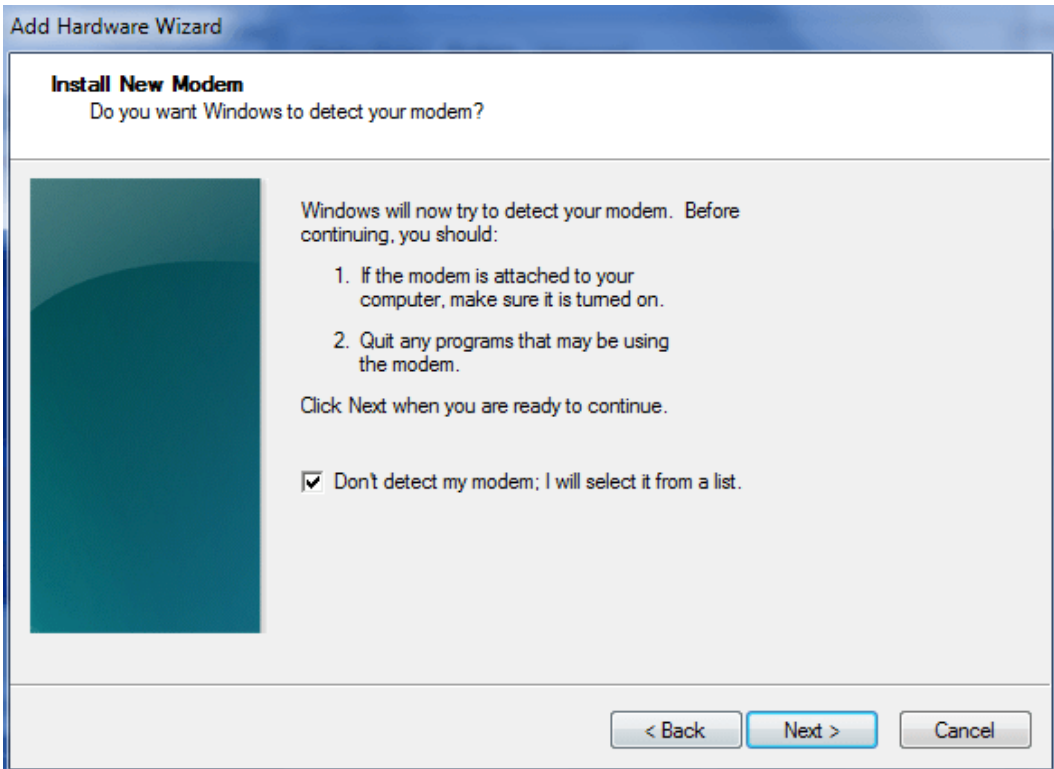

3. Click **Standard Modem Types->Standard 33600 bps Modem**, then click **Next**.

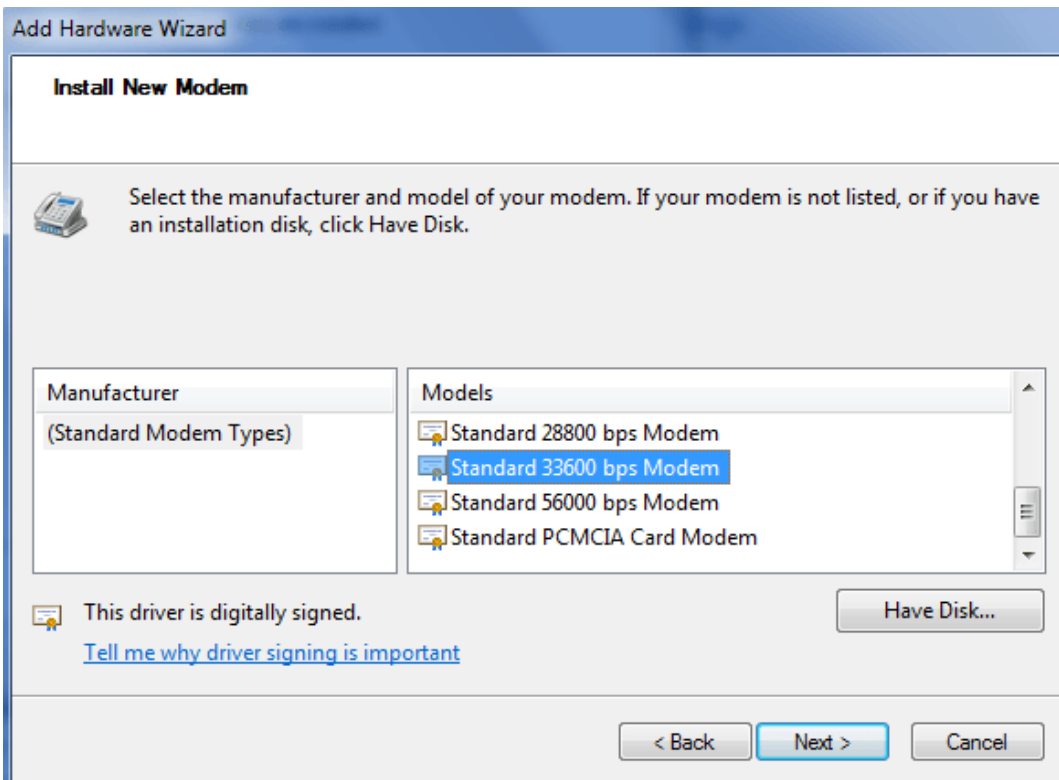

4. Select the port you want to install the modem on (the port which M1000 MP connects to PC), then click **Next**.

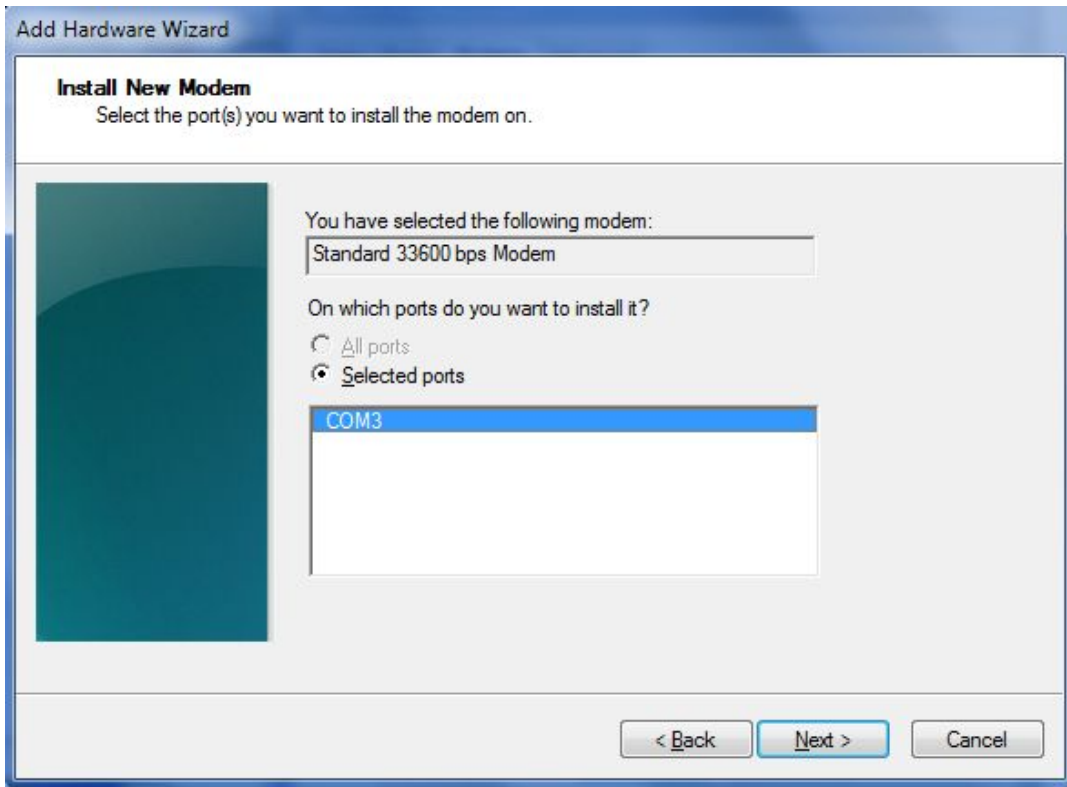

5. The modem installation is finished, click **Finish**.

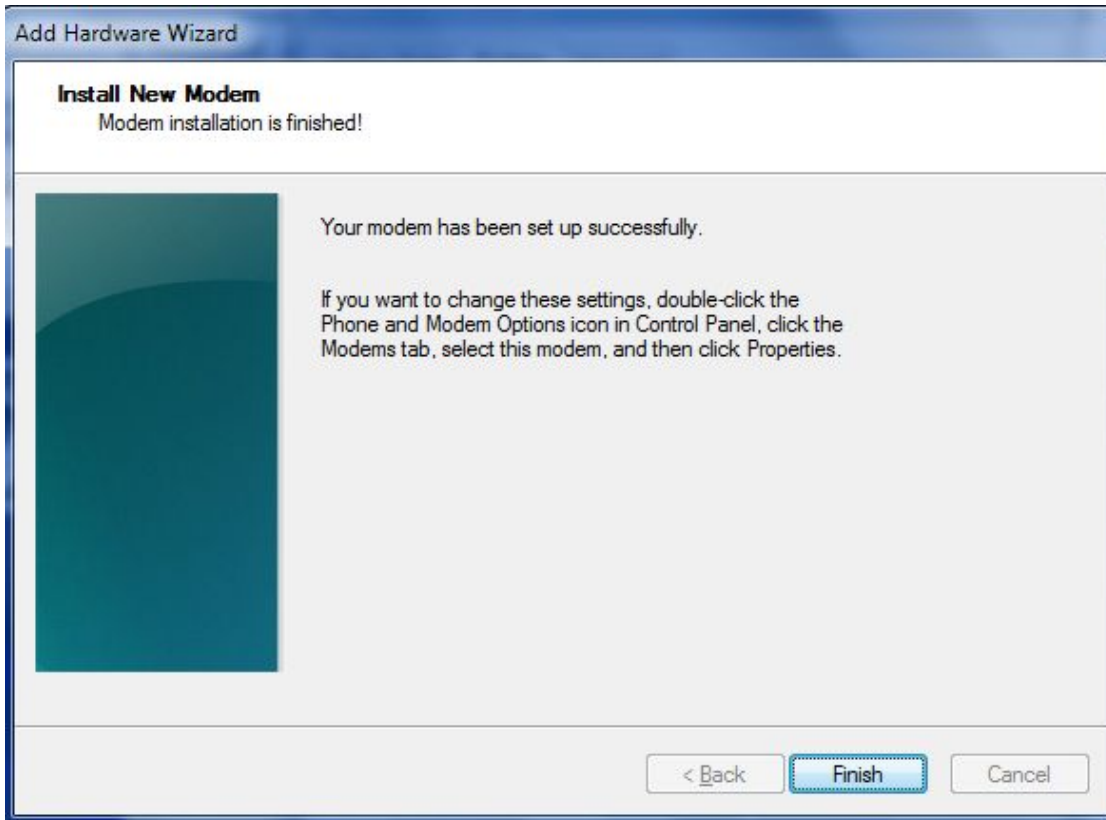

6. At this point, the modem driver should be listed on the **Modems** tab under **Phone and Modem Options**.

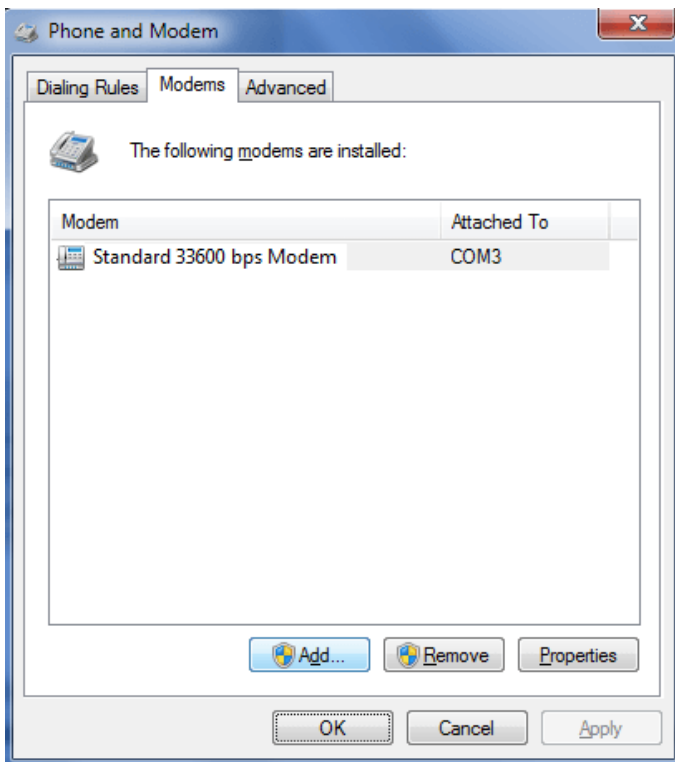

- **Set Maximum Port Speed**

1. Click **Properties**.

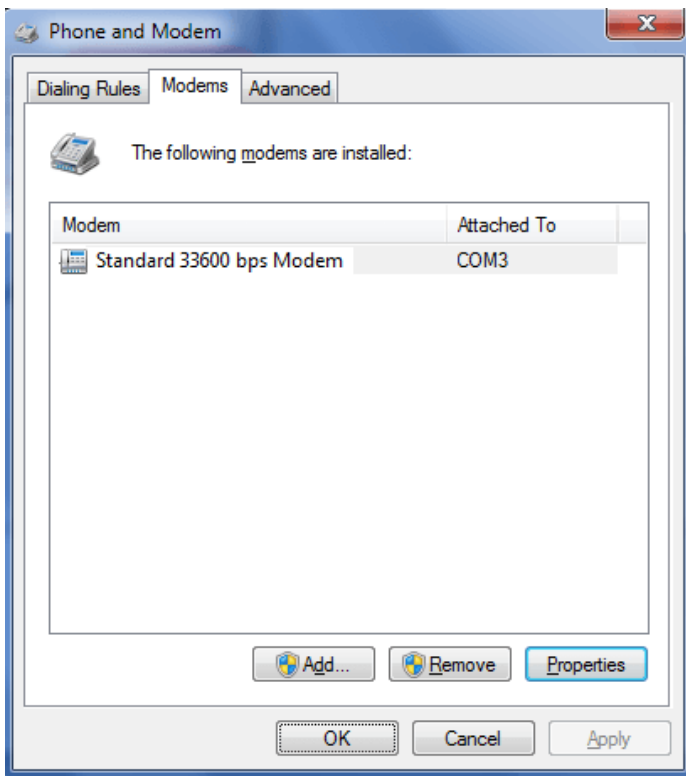

2. Click the **Modem** tab next, select 115200 at **Maximum Port Speed** then click **OK**.

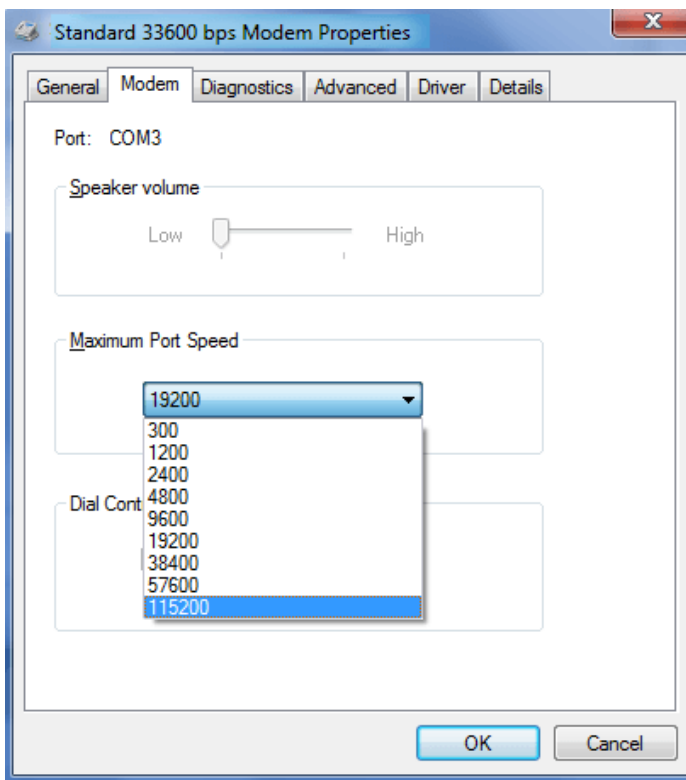

• **Modem Diagnostics**

Follow these steps to verify that the modem is installed properly and has been activated.

1. Click the **Diagnostics** tab, and then click **Query Modem**. After that it will popup “Please Wait” window. This process will almost take you 20seconds.

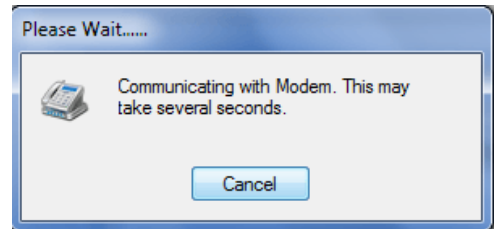
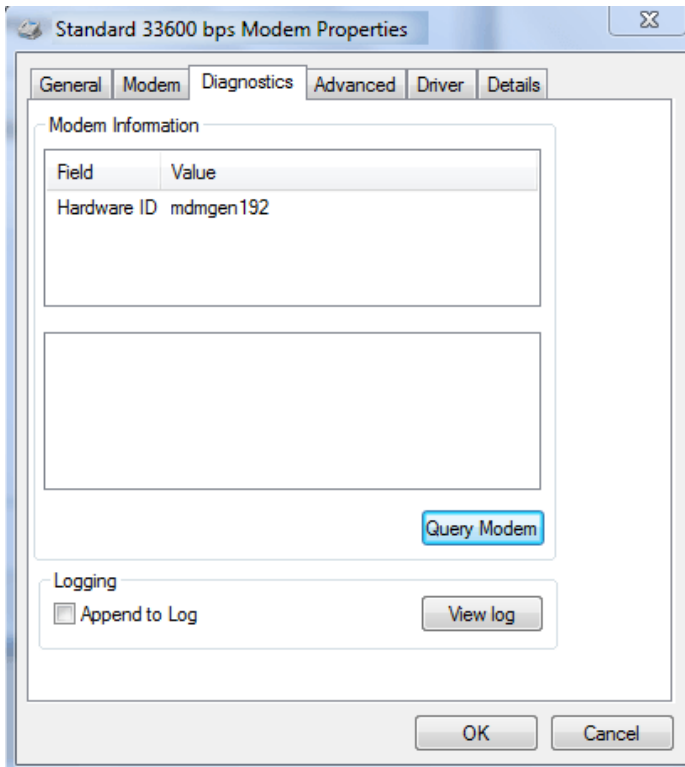

2. If the query is successful, both commands sent to the modem and responses from the modem will be displayed.

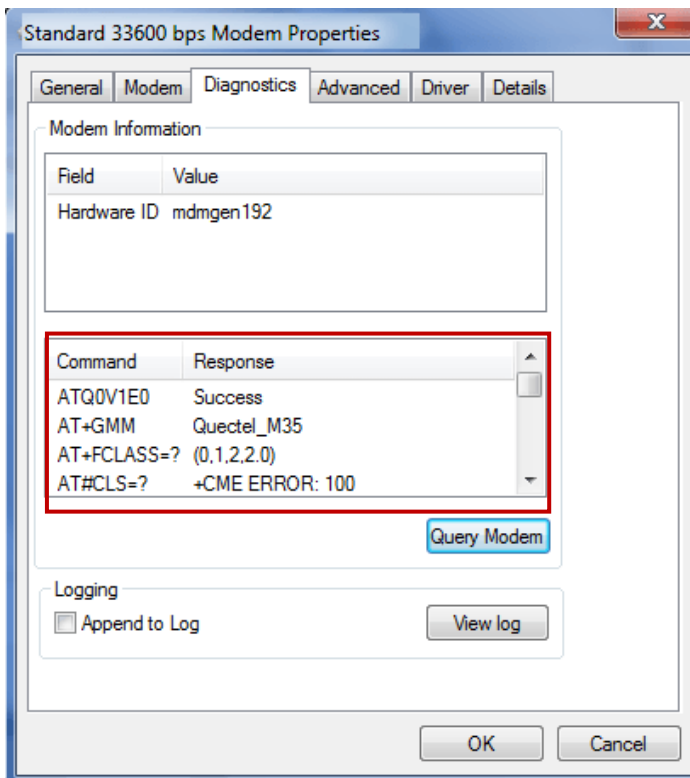



- **Setting up the APN**

Before using the GPRS on the Windows DUN, the APN (Access Point Name) must be added as a modem initialization command. Detailed instructions are shown below.

1. Click the **Advanced** tab.
2. Enter the following commands in the field of **Extra initialization commands**:

**AT+CGDCONT=1,"IP",<APN>**

Replace <APN> with the correct service for your account. For example:

**AT+CGDCONT=1,"IP","3gnet"**

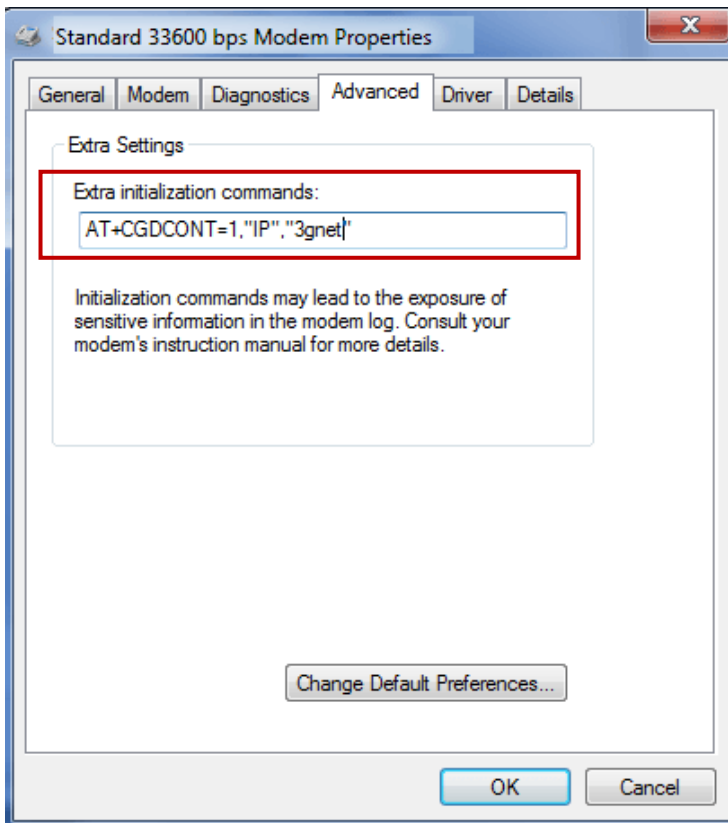

3. Click **Change Default Preferences**.

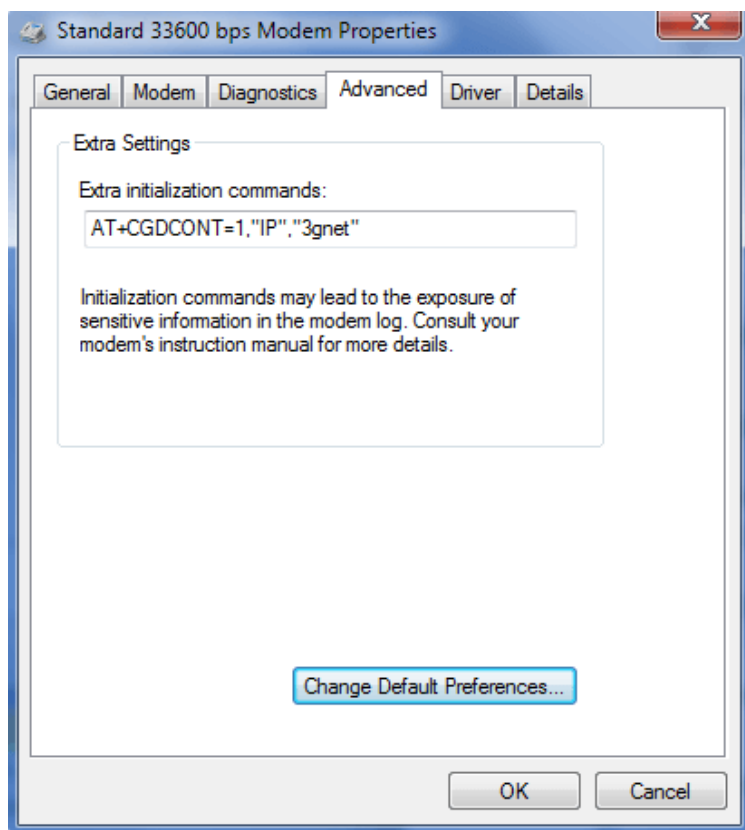

4. Select Port speed as **115200** and Flow control as **None**, and then click **OK**.

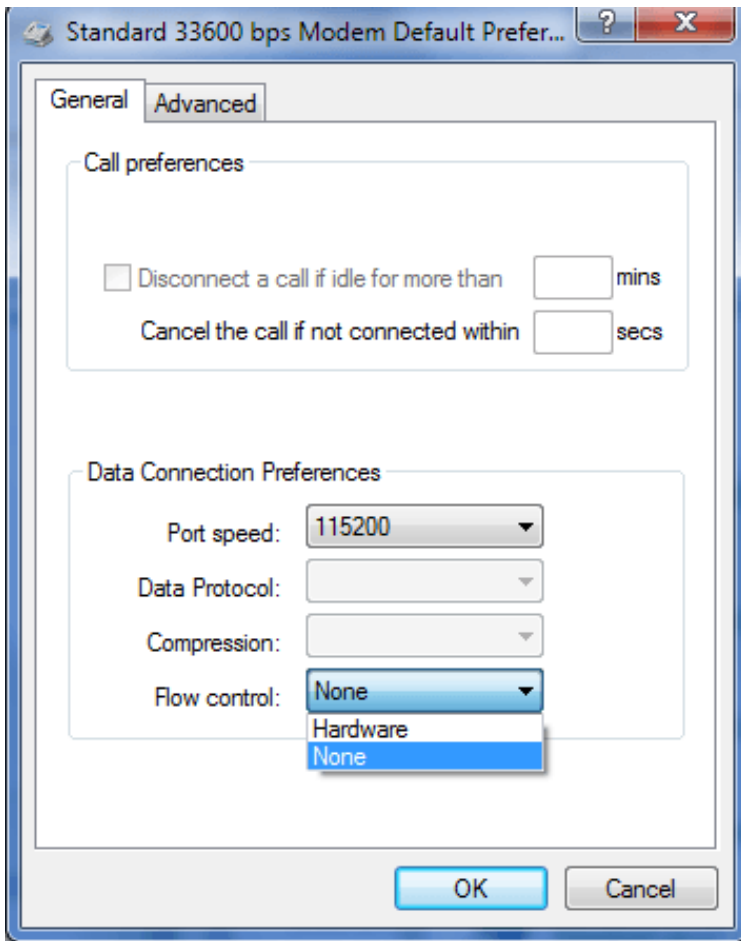

5. Click **OK** to close the **Properties** window.
6. Click **OK** to close the **Modems** window.

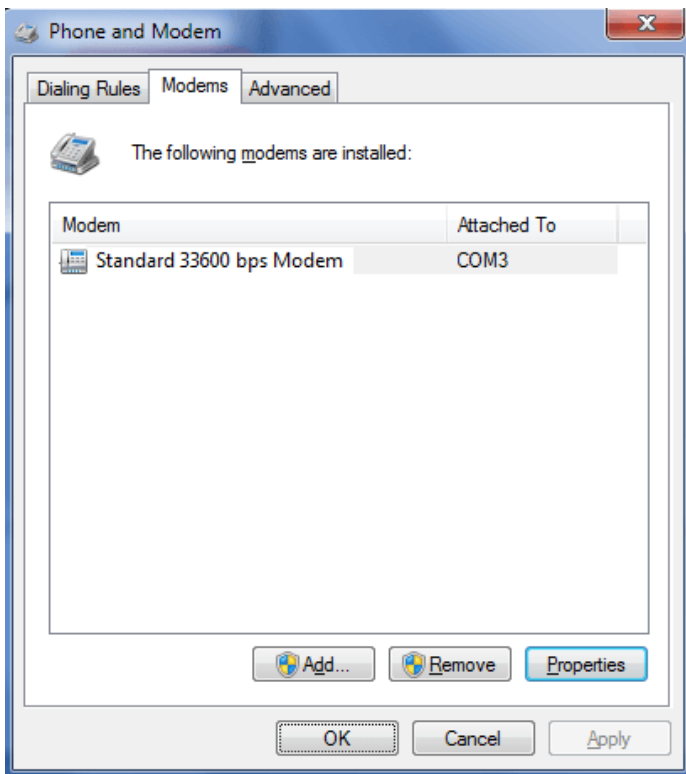

- **Adding Windows DUN**

Follow these steps to add Windows Dial-up Networking.

1. In the Control Panel, open **Network and Sharing Center**, and then click **Set up a new connection or network**.
2. When the **Set Up a Connection or Network** window opens, select the **Connect to the Internet** option, and then click **Next**.

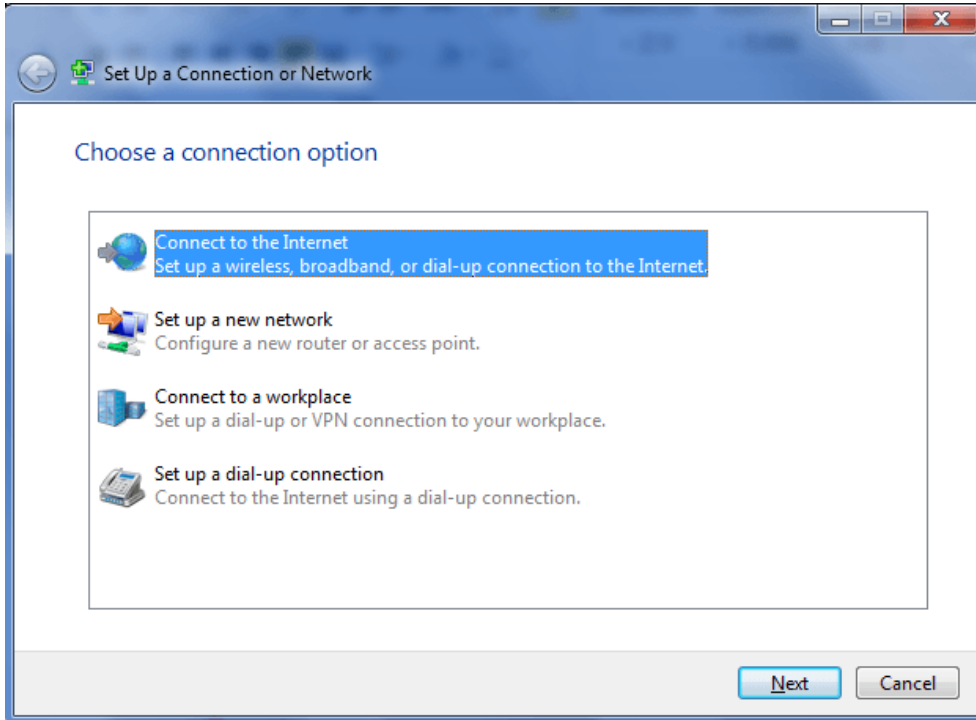

3. Select the **No, create a new connection** option, and then click **Next**.

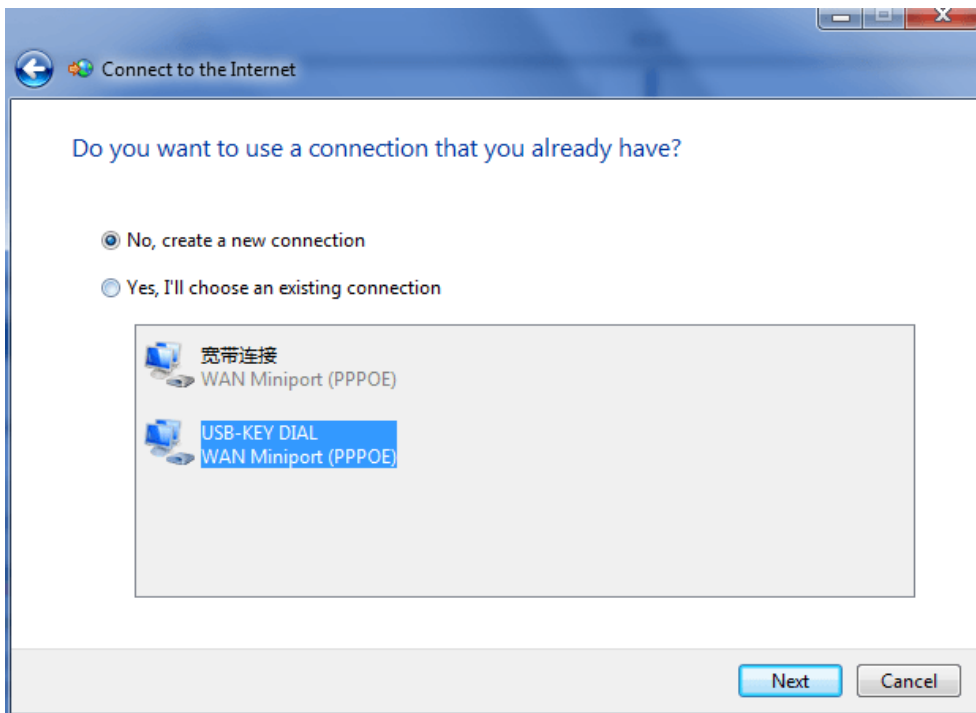

4. Select the **Dial up** option.

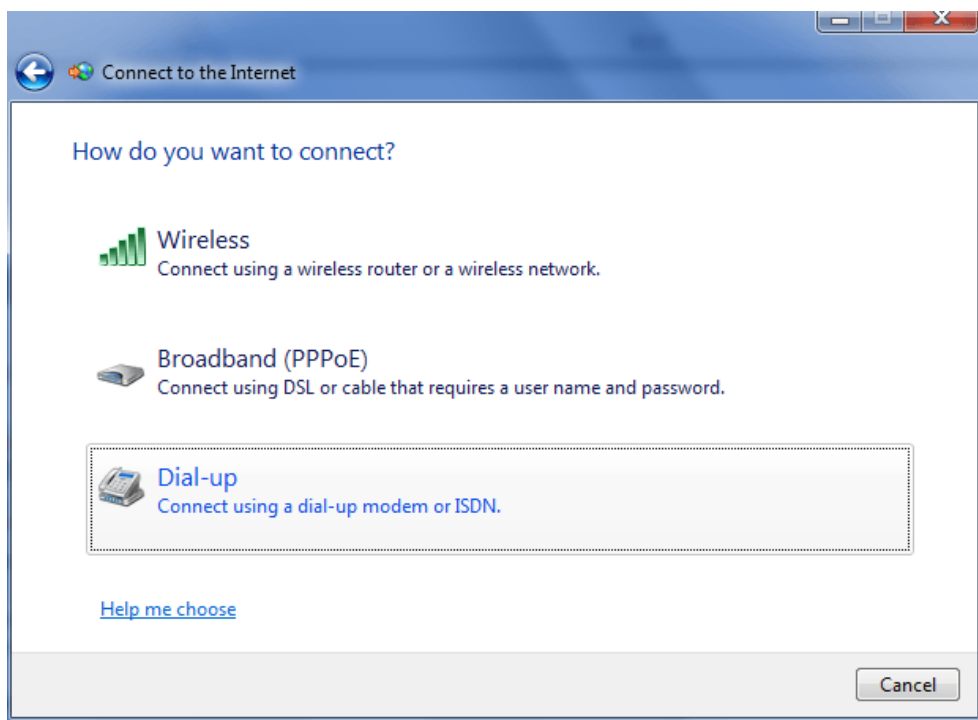

5. Type **\*99\*\*\*1#** in the Phone number text input box, and type the **User name** and **Password** in the appropriate text boxes, and then click **Connect**.

*Note: **User Name** and **Password** is used for cellular dial-up connection, you can check with local ISP whether you need to enter and what you need to enter.*

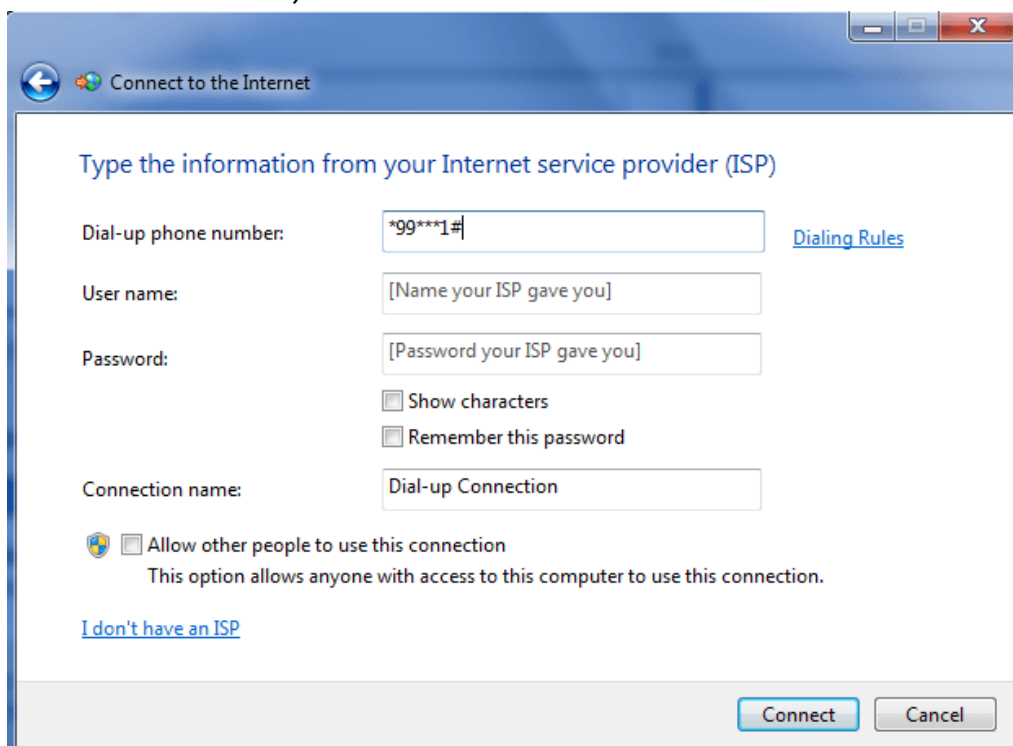

6. After dial up successfully, it will show window below.

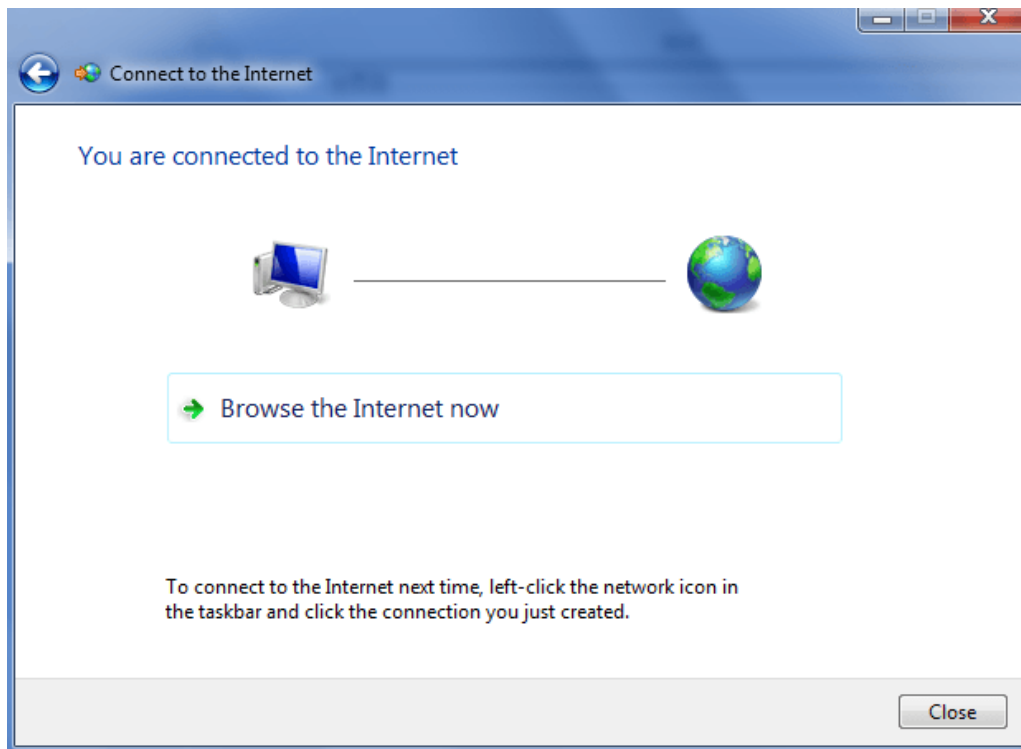

7. Also you can try to ping to [www.google.com](http://www.google.com) to check whether GPRS connection has been established.

```
Administrator: C:\Windows\system32\cmd.exe
Microsoft Windows [Version 6.1.7601]
Copyright (c) 2009 Microsoft Corporation. All rights reserved.

C:\Users\Administrator>ping www.google.com

Pinging www.google.com [173.194.127.49] with 32 bytes of data:
Reply from 173.194.127.49: bytes=32 time=1837ms TTL=50
Reply from 173.194.127.49: bytes=32 time=359ms TTL=50
Request timed out.
Reply from 173.194.127.49: bytes=32 time=214ms TTL=50

Ping statistics for 173.194.127.49:
    Packets: Sent = 4, Received = 3, Lost = 1 (25% loss),
    Approximate round trip times in milli-seconds:
        Minimum = 214ms, Maximum = 1837ms, Average = 803ms

C:\Users\Administrator>
```

## Chapter 4 Appendix

### 4.1 GSM Alphabet

Standard SMS can contain 160 characters. However, the characters typed must be part of the so-called 7-bit default alphabet as specified by GSM 3.38. You can see in the table below that this alphabet contains all ASCII characters and some accented characters.

For example, u umlaut (ü) and e with grave (è), are in this set. Please study the table below to have a complete overview. Using any character not in this set, will make the SMS a Unicode SMS and limit the length of the SMS to 70 characters.

Note: a few characters actually count as two characters. These characters are:

{ } [ ] ~ \ and the Euro symbol: €

You can also see that in the table below in the hex column. These characters need to be escaped.

Below is the 7 bit default alphabet as specified by GSM 03.38. The corresponding ISO-8859-1 decimal codes are shown in the rightmost column. Note that the euro sign (€) is also included.

Hex	Dec	Character name	Character	ISO-8859-1 DEC
0x00	0	COMMERCIAL AT	@	64
0x01	1	POUND SIGN	£	163
0x02	2	DOLLAR SIGN	\$	36
0x03	3	YEN SIGN	¥	165
0x04	4	LATIN SMALL LETTER E WITH GRAVE	è	232
0x05	5	LATIN SMALL LETTER E WITH ACUTE	é	233
0x06	6	LATIN SMALL LETTER U WITH GRAVE	ù	249
0x07	7	LATIN SMALL LETTER I WITH GRAVE	ì	236
0x08	8	LATIN SMALL LETTER O WITH GRAVE	ò	242
0x09	9	LATIN CAPITAL LETTER C WITH CEDILLA	Ç	199
0x0A	10	LINE FEED		10
0x0B	11	LATIN CAPITAL LETTER O WITH STROKE	Ø	216
0x0C	12	LATIN SMALL LETTER O WITH STROKE	ø	248
0x0D	13	CARRIAGE RETURN		13
0x0E	14	LATIN CAPITAL LETTER A WITH RING ABOVE	Å	197
0x0F	15	LATIN SMALL LETTER A WITH RING ABOVE	å	229
0x10	16	GREEK CAPITAL LETTER DELTA	Δ	
0x11	17	LOW LINE	_	95
0x12	18	GREEK CAPITAL LETTER PHI	Φ	
0x13	19	GREEK CAPITAL LETTER GAMMA	Γ	
0x14	20	GREEK CAPITAL LETTER LAMBDA	Λ	
0x15	21	GREEK CAPITAL LETTER OMEGA	Ω	
0x16	22	GREEK CAPITAL LETTER PI	Π	
0x17	23	GREEK CAPITAL LETTER PSI	Ψ	

0x18	24	GREEK CAPITAL LETTER SIGMA	Σ	
0x19	25	GREEK CAPITAL LETTER THETA	Θ	
0x1A	26	GREEK CAPITAL LETTER XI	Ξ	
0x1B	27	ESCAPE TO EXTENSION TABLE		
0x1B0A	27 10	FORM FEED		12
0x1B14	27 20	CIRCUMFLEX ACCENT	^	94
0x1B28	27 40	LEFT CURLY BRACKET	{	123
0x1B29	27 41	RIGHT CURLY BRACKET	}	125
0x1B2F	27 47	REVERSE SOLIDUS (BACKSLASH)	\	92
0x1B3C	27 60	LEFT SQUARE BRACKET	[	91
0x1B3D	27 61	TILDE	~	126
0x1B3E	27 62	RIGHT SQUARE BRACKET	]	93
0x1B40	27 64	VERTICAL BAR		124
0x1B65	27 101	EURO SIGN	€	164 (ISO-8859-15)
0x1C	28	LATIN CAPITAL LETTER AE	Æ	198
0x1D	29	LATIN SMALL LETTER AE	æ	230
0x1E	30	LATIN SMALL LETTER SHARP S (German)	ß	223
0x1F	31	LATIN CAPITAL LETTER E WITH ACUTE	É	201
0x20	32	SPACE		32
0x21	33	EXCLAMATION MARK	!	33
0x22	34	QUOTATION MARK	“	34
0x23	35	NUMBER SIGN	#	35
0x24	36	CURRENCY SIGN	¤	164 (ISO-8859-1)
0x25	37	PERCENT SIGN	%	37
0x26	38	AMPERSAND	&	38
0x27	39	APOSTROPHE	'	39
0x28	40	LEFT PARENTHESIS	(	40
0x29	41	RIGHT PARENTHESIS	)	41
0x2A	42	ASTERISK	*	42
0x2B	43	PLUS SIGN	+	43
0x2C	44	COMMA	,	44
0x2D	45	HYPHEN-MINUS	-	45
0x2E	46	FULL STOP	.	46
0x2F	47	SOLIDUS (SLASH)	/	47
0x30	48	DIGIT ZERO	0	48
0x31	49	DIGIT ONE	1	49
0x32	50	DIGIT TWO	2	50
0x33	51	DIGIT THREE	3	51
0x34	52	DIGIT FOUR	4	52
0x35	53	DIGIT FIVE	5	53
0x36	54	DIGIT SIX	6	54
0x37	55	DIGIT SEVEN	7	55



0x38	56	DIGIT EIGHT	8	56
0x39	57	DIGIT NINE	9	57
0x3A	58	COLON	:	58
0x3B	59	SEMICOLON	;	59
0x3C	60	LESS-THAN SIGN	<	60
0x3D	61	EQUALS SIGN	=	61
0x3E	62	GREATER-THAN SIGN	>	62
0x3F	63	QUESTION MARK	?	63
0x40	64	INVERTED EXCLAMATION MARK	!	161
0x41	65	LATIN CAPITAL LETTER A	A	65
0x42	66	LATIN CAPITAL LETTER B	B	66
0x43	67	LATIN CAPITAL LETTER C	C	67
0x44	68	LATIN CAPITAL LETTER D	D	68
0x45	69	LATIN CAPITAL LETTER E	E	69
0x46	70	LATIN CAPITAL LETTER F	F	70
0x47	71	LATIN CAPITAL LETTER G	G	71
0x48	72	LATIN CAPITAL LETTER H	H	72
0x49	73	LATIN CAPITAL LETTER I	I	73
0x4A	74	LATIN CAPITAL LETTER J	J	74
0x4B	75	LATIN CAPITAL LETTER K	K	75
0x4C	76	LATIN CAPITAL LETTER L	L	76
0x4D	77	LATIN CAPITAL LETTER M	M	77
0x4E	78	LATIN CAPITAL LETTER N	N	78
0x4F	79	LATIN CAPITAL LETTER O	O	79
0x50	80	LATIN CAPITAL LETTER P	P	80
0x51	81	LATIN CAPITAL LETTER Q	Q	81
0x52	82	LATIN CAPITAL LETTER R	R	82
0x53	83	LATIN CAPITAL LETTER S	S	83
0x54	84	LATIN CAPITAL LETTER T	T	84
0x55	85	LATIN CAPITAL LETTER U	U	85
0x56	86	LATIN CAPITAL LETTER V	V	86
0x57	87	LATIN CAPITAL LETTER W	W	87
0x58	88	LATIN CAPITAL LETTER X	X	88
0x59	89	LATIN CAPITAL LETTER Y	Y	89
0x5A	90	LATIN CAPITAL LETTER Z	Z	90
0x5B	91	LATIN CAPITAL LETTER A WITH DIAERESIS	Ä	196
0x5C	92	LATIN CAPITAL LETTER O WITH DIAERESIS	Ö	214
0x5D	93	LATIN CAPITAL LETTER N WITH TILDE	Ñ	209
0x5E	94	LATIN CAPITAL LETTER U WITH DIAERESIS	Ü	220
0x5F	95	SECTION SIGN	§	167
0x60	96	INVERTED QUESTION MARK	¿	191
0x61	97	LATIN SMALL LETTER A	a	97

0x62	98	LATIN SMALL LETTER B	b	98
0x63	99	LATIN SMALL LETTER C	c	99
0x64	100	LATIN SMALL LETTER D	d	100
0x65	101	LATIN SMALL LETTER E	e	101
0x66	102	LATIN SMALL LETTER F	f	102
0x67	103	LATIN SMALL LETTER G	g	103
0x68	104	LATIN SMALL LETTER H	h	104
0x69	105	LATIN SMALL LETTER I	i	105
0x6A	106	LATIN SMALL LETTER J	j	106
0x6B	107	LATIN SMALL LETTER K	k	107
0x6C	108	LATIN SMALL LETTER L	l	108
0x6D	109	LATIN SMALL LETTER M	m	109
0x6E	110	LATIN SMALL LETTER N	n	110
0x6F	111	LATIN SMALL LETTER O	o	111
0x70	112	LATIN SMALL LETTER P	p	112
0x71	113	LATIN SMALL LETTER Q	q	113
0x72	114	LATIN SMALL LETTER R	r	114
0x73	115	LATIN SMALL LETTER S	s	115
0x74	116	LATIN SMALL LETTER T	t	116
0x75	117	LATIN SMALL LETTER U	u	117
0x76	118	LATIN SMALL LETTER V	v	118
0x77	119	LATIN SMALL LETTER W	w	119
0x78	120	LATIN SMALL LETTER X	x	120
0x79	121	LATIN SMALL LETTER Y	y	121
0x7A	122	LATIN SMALL LETTER Z	z	122
0x7B	123	LATIN SMALL LETTER A WITH DIAERESIS	ä	228
0x7C	124	LATIN SMALL LETTER O WITH DIAERESIS	ö	246
0x7D	125	LATIN SMALL LETTER N WITH TILDE	ñ	241
0x7E	126	LATIN SMALL LETTER U WITH DIAERESIS	ü	252
0x7F	127	LATIN SMALL LETTER A WITH GRAVE	à	224

## 4.2 Troubleshooting

This section of the document describes possible problems encountered when using the Robustel M1000 MP and their solutions.

### 4.2.1 The modem's LED does not light:

- Check if modem has connected to a proper power supply.

- Check if the power connector is properly inserted.

## 4.2.2 The modem keep rebooting all the time:

- Please make sure you have inserted the SIM card.

## 4.2.3 No connection with modem through serial link

- Check if the serial cable has been connected properly.
- Check if the serial cable has been made by following pin assignment given in section 2.6 **PIN assignmen** for RS232.
- Check if your program has proper setting. Factory setting of the modem is 115200,8,n,1.
- Check if there is another program interfering with the communication program, such as conflict on communication port access.

## 4.2.4 Receiving “No Carrier” Message

If the modem returns a “No Carrier” message upon an attempted call (voice or data), then refer to the table below for possible causes and solutions.

If the modem returns...	Then ask...	Action...
“No Carrier”	Is the received signal strong enough?	Use “AT+CSQ” to check RSSI, please check Signal Strength Indication.
	Is the antenna properly connected?	Refer to section 2.6
“No Carrier” (when trying to issue a voice communication)	Is the semicolon (;) entered immediately after the phone number in the AT command?	Ensure that the semicolon (;) is entered immediately after the phone number in the AT command. e.g. ATD123456;
“No Carrier” (when trying to issue a data communication)	Is the SIM card configured for data / fax calls?	Configure the SIM card for data / fax calls (Ask your network provider if necessary).
	Is the selected bearer type supported by the called party?	Ensure that the selected bearer type is supported by the called party.
	Is the selected bearer type supported by the network?	Ensure that the selected bearer type is supported by the network. If no success, try bearer select type by AT command: AT+CBST=0,0,3

### Signal Strength Indication

Value of received signal strength indication (RSSI)	Interpretation of the received signal strength
0 to 12	Insufficient or weak

13 to 19	Average
20 to 31	Good
99	No signal

### 4.3 Terms and Abbreviations

Abbreviations	Description
AC	Alternating Current
APN	Access Point Name of GPRS Service Provider Network
CE	Conformité Européene (European Conformity)
CHAP	Challenge Handshake Authentication Protocol
CSD	Circuit Switched Data
CTS	Clear to Send
dB	Decibel
dBi	Decibel Relative to an Isotropic radiator
DC	Direct Current
DCD	Data Carrier Detect
DCE	Data Communication Equipment (typically modems)
DCS 1800	Digital Cellular System, also referred to as PCN
DI	Digital Input
DO	Digital Output
DSR	Data Set Ready
DTE	Data Terminal Equipment
DTMF	Dual Tone Multi-frequency
DTR	Data Terminal Ready
EMC	Electromagnetic Compatibility
EMI	Electromagnetic Interference
ESD	Electrostatic Discharges
ETSI	European Telecommunications Standards Institute
GND	Ground
GPRS	General Package Radio Service
GSM	Global Standard for Mobile Communications
IMEI	International Mobile Equipment Identification
kbps	kbits per second
LED	Light Emitting Diode
MAX	Maximum
Min	Minimum
MO	Mobile Originated
MS	Mobile Station
MT	Mobile Terminated
PAP	Password Authentication Protocol

PC	Personal Computer
PCN	Personal Communications Network, also referred to as DCS 1800
PCS	Personal Communication System, also referred to as GSM 1900
PDU	Protocol Data Unit
PPP	Point-to-point Protocol
PIN	Personal Identity Number
PSU	Power Supply Unit
PUK	Personal Unblocking Key
R&TTE	Radio and Telecommunication Terminal Equipment
RF	Radio Frequency
RTC	Real Time Clock
RTS	Request to Send
Rx	Receive Direction
SIM	Subscriber Identification Module
SMA	Subminiature Version A RF Connector
SMS	Short Message Service
TCP/IP	Transmission Control Protocol / Internet Protocol
TE	Terminal Equipment, also referred to as DTE
Tx	Transmit Direction
UART	Universal Asynchronous Receiver-transmitter
USSD	Unstructured Supplementary Service Data
VSWR	Voltage Stationary Wave Ratio