

Robustel GoRugged M1000 XP

Industrial Serial to Cellular Gateway

For GSM/GPRS/UMTS Networks

User Guide

Document Name:	User Guide
Firmware:	1.0.0
M1000 XP Configurator:	1.0.0
Date:	2013-11-23
Status:	Confidential
Doc ID:	RT_UG_M1000 XP_v.1.0.0



Robustel

www.robustel.com

About This Document

This document describes the hardware and software of the *Robustel M1000 XP Industrial Serial to Cellular Gateway*.

**Copyright© Guangzhou Robustel Technologies Co., Limited
All Rights Reserved.**

Trademarks and Permissions

Robustel are trademark of Guangzhou Robustel Technologies Co. Limited.

All other trademarks and trade names mentioned in this document are the property of their respective holders.

Disclaimer

No part of this document may be reproduced in any form without the written permission of the copyright owner. The contents of this document are subject to revision without notice due to continued progress in methodology, design and manufacturing. Robustel shall have no liability for any error or damage of any kind resulting from the use of this document.

Technical Support Contact Information

Tel: +86-18924045664

Fax: +86-20-82321505

E-mail: support@robustel.com

Web: www.robustel.com

Important Notice

Due to the nature of wireless communications, transmission and reception of data can never be guaranteed. Data may be delayed, corrupted (i.e., have errors) or be totally lost. Although significant delays or losses of data are rare when wireless devices such as the gateway are used in a normal manner with a well-constructed network, the gateway should not be used in situations where failure to transmit or receive data could result in damage of any kind to the user or any other party, including but not limited to personal injury, death, or loss of property. Robustel accepts no responsibility for damages of any kind resulting from delays or errors in data transmitted or received using the gateway, or for failure of the gateway to transmit or receive such data.

Safety Precautions

General

- The gateway generates radio frequency (RF) power. When using the gateway care must be taken on safety issues related to RF interference as well as regulations of RF equipment.
- Do not use your gateway in aircraft, hospitals, petrol stations or in places where using cellular products is prohibited.
- Be sure that the gateway will not be interfering with nearby equipment. For example: pacemakers or medical equipment. The antenna of the gateway should be away from computers, office equipment, home appliance, etc.
- An external antenna must be connected to the gateway for proper operation. Only uses approved antenna with the gateway. Please contact authorized distributor on finding an approved antenna.
- Always keep the antenna with minimum safety distance of 26.6 cm or more from human body. Do not put the antenna inside metallic box, containers, etc.

Note: *Some airlines may permit the use of cellular phones while the aircraft is on the ground and the door is open. Gateway may be used at this time.*

Using the gateway in vehicle

- Check for any regulation or law authorizing the use of cellular in vehicle in your country before installing the gateway.
- The driver or operator of any vehicle should not operate the gateway while in control of a vehicle.
- Install the gateway by qualified personnel. Consult your vehicle distributor for any possible interference of electronic parts by the gateway.
- The gateway should be connected to the vehicle's supply system by using a fuse-protected terminal in the vehicle's fuse box.
- Be careful when the gateway is powered by the vehicle's main battery. The battery may be drained after extended period.

Protecting your gateway

- To ensure error-free usage, please install and operate your gateway with care. Do remember the follow:
- Do not expose the gateway to extreme conditions such as high humidity / rain, high temperatures, direct sunlight, caustic / harsh chemicals, dust, or water.
- Do not try to disassemble or modify the gateway. There is no user serviceable part inside and the warranty would be void.

- Do not drop, hit or shake the gateway. Do not use the gateway under extreme vibrating conditions.
- Do not pull the antenna or power supply cable. Attach/detach by holding the connector.
- Connect the gateway only according to the instruction manual. Failure to do it will void the warranty.
- In case of problem, please contact authorized distributor.

Regulatory and Type Approval Information

Table 1: Directives



2002/95/EC	Directive of the European Parliament and of the Council of 27 January 2003 on the restriction of the use of certain hazardous substances in electrical and electronic equipment (RoHS)	
2002/96/EC	Directive of the European Parliament and of the Council on waste electrical and electronic equipment (WEEE)	
2003/108/EC	Directive of the European Parliament and of the Council of 8 December 2003 amending directive 2002/96/ec on waste electrical and electronic equipment (WEEE)	

Table 2: Standards of the Ministry of Information Industry of the People’s Republic of China

SJ/T 11363-2006	“Requirements for Concentration Limits for Certain Hazardous Substances in Electronic Information Products” (2006-06).	
SJ/T 11364-2006	<p>“Marking for Control of Pollution Caused by Electronic Information Products” (2006-06).</p> <p>According to the “Chinese Administration on the Control of Pollution caused by Electronic Information Products” (ACPEIP) the EPUP, i.e., Environmental Protection Use Period, of this product is 20 years as per the symbol shown here, unless otherwise marked. The EPUP is valid only as long as the product is operated within the operating limits described in the Hardware Interface Description.</p> <p>Please see Table 3 for an overview of toxic or hazardous substances or elements that might be contained in product parts in concentrations above the limits defined by SJ/T 11363-2006.</p>	

Table 3: Toxic or hazardous substances or elements with defined concentration limits

Name of the part	Hazardous substances					
	(Pb)	(Hg)	(Cd)	(Cr(VI))	(PBB)	(PBDE)
Metal Parts	o	o	o	o	o	o
Circuit Modules	x	o	o	o	o	o
Cables and Cable Assemblies	o	o	o	o	o	o
Plastic and Polymeric parts	o	o	o	o	o	o

o:
Indicates that this toxic or hazardous substance contained in all of the homogeneous materials for this part is below the limit requirement in SJ/T11363-2006.

x:
Indicates that this toxic or hazardous substance contained in at least one of the homogeneous materials for this part *might exceed* the limit requirement in SJ/T11363-2006.

Revision History

Updates between document versions are cumulative. Therefore, the latest document version contains all updates made to previous versions.

Release Date	Firmware Version	Details
2013-11-23	1.00	First Release

Contents

Chapter 1.	Product Concept.....	8
1.1	Overview	8
1.2	Packing List	8
1.3	Specifications	11
1.4	Dimensions.....	12
1.5	Selection and Ordering Data	12
Chapter 2.	Installation.....	13
2.1	Overview	13
2.2	LED Indicators.....	13
2.3	PIN assignment.....	14
2.4	USB interface	14
2.5	Install SIM Card.....	15
2.6	Connect the External Antenna (SMA Type).....	15
2.7	Connect the Gateway to External Device	16
2.8	Mount the Gateway	16
2.9	Power Supply.....	17
Chapter 3.	Operate the Gateway	18
3.1	M1000 XP Configurator Overview.....	18
3.2	Management via RS-232/USB port	19
3.3	Management via TCP connection.....	19
3.4	Operation Area Introduction.....	21
3.5	Export and Import Profiles	22
3.6	COM.....	24
3.7	GPRS	25
3.8	Connection	27
3.9	DDNS	30
3.10	Phone Group	31
3.11	Status.....	32
3.12	Wakeup	34
3.13	Reboot.....	36
3.14	SNTP	38
3.15	Modbus	40
3.16	NMS.....	40
3.17	Management.....	42
Chapter 4.	Typical Applications.....	44
4.1	Overview	44
4.2	Typical Applications.....	45
4.2.1	TCP Client Mode	45
4.2.2	TCP Server Mode	47
4.2.3	UDP Mode	49
4.2.4	Virtual COM Mode.....	49
Chapter 5.	Appendix	50

- 5.1 Factory Settings 50
- 5.2 M1000 XP SMS Command for Remote Control..... 50
 - 5.2.1 SMS Commands Structure 50
 - 5.2.2 SMS Control Steps 50
 - 5.2.3 SMS Commands List 51
 - 5.2.4 SMS Control Examples 54
- 5.3 Troubleshooting 55
 - 5.3.1 The gateway's LED does not light: 55
 - 5.3.2 No connection with gateway through serial link..... 55
 - 5.3.3 GSM/GPRS/UMTS connection cannot be established..... 55
- 5.4 Terms and Abbreviations..... 55

Chapter 1. Product Concept

1.1 Overview

Robustel GoRugged M1000 XP is a compact design serial to cellular gateway with plastic housing, offering state-of-the-art GSM/GPRS/UMTS connectivity for machine to machine (M2M) applications.

- Auto GPRS/UMTS connect or reconnect (no AT commands required).
- Support CSD communication (only receive CSD call).
- Transparent TCP and UDP socket connections.
- Supports ICMP, DDNS, SNTP, Telnet.
- Supports Modbus RTU to Modbus TCP.
- Auto reboot via SMS/Caller ID/Timing.
- Various dial-up policies: Always Online/Connect on Demand.
- Supports RobustLink (Centralized M2M management platform).
- Configuration methods: RS232/USB/SMS/TCP/RobustLink.
- Firmware upgrade via RS232/USB/TCP/RobustLink.
- Two tri-color LED indicators provide signal strength (RSSI) and running status.
- Watchdog for reliable communications.
- Wide range input voltages from 6 to 18 VDC and extreme operating temperature.
- The plastic enclosure can be mounted on a DIN-rail or on the wall, also with extra ground screw.

1.2 Packing List

Check your package to make certain it contains the following items:

- Robustel GoRugged M1000 XP gateway x1



- 3.5mm 2-pin pluggable terminal block for power connector x1



- CD with user guide and configuration utility x1

Note: Please notify your sales representative if any of the above items are missing or damaged.

Optional accessories (can be purchased separately):

- SMA antenna (Stubby antenna or Magnet antenna optional) x1

Stubby antenna

Magnet antenna



- Serial cable for RS232 (DB9 Female to DB9 Male, 1 meter) x1



- Mini USB cable x1



- Wall Mounting Kit



- 35mm Din-Rail mounting kit



- AC/DC Power Supply Adapter (12VDC, 1A) x1



- DB9 Male to terminal block for serial port

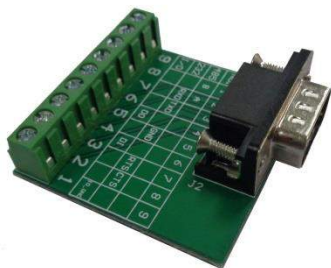

1.3 Specifications

Cellular Interface

- Standards: GSM/GPRS/UMTS
- GPRS: max. 86 kbps (DL & UL), class 10
- UMTS: max. 384 kbps (DL & UL)
- Frequency: GSM 850/900/1800/1900 MHz
UMTS 850/1900 MHz or 900/2100
- CSD: Up to 9.6 kbps
- SIM: 1 x (3V & 1.8V)
- Antenna Interface: SMA Female

Serial Interface

- Number of Ports: 1 x DB9 Female
- Serial Standards: RS232 or RS485
- ESD Protection: 15KV
- Baudrate: 1200bps to 115200bps
- RS-232: TxD, RxD, RTS, CTS, GND
- RS-485: Data+ (A), Data- (B), GND

USB Interface

- Number of Ports: 1 x USB port for configuration
- Standards: Mini USB

System

- LED Indicators: 2 tri-color LED indicators, RUN, 3 level RSSI
- Real Time Clock: Built-in real time clock
- Watchdog and Timer: Built-in watchdog and timer

Software

- IP protocols: PPP, TCP, UDP, ICMP, DDNS, SNTP, Telnet
- Serial Port: TCP client/server, UDP, Modbus RTU to Modbus TCP, Virtual COM (COM port redirector)
- RobustLink: Centralized M2M management platform

Power Supply and Consumption

- Power Supply Interface: 2-pin 3.5mm pluggable terminal block
- Input Voltage: 6 to 18 VDC
- Power Consumption: Idle: 50-60 mA @ 12 V
Data Link: 100 to 200 mA (peak) @ 12 V

Physical Characteristics

- Housing & Weight: Plastic, 105g
- Dimension(L x W x H): 75 x 85 x 28 mm
- Installation: 35mm Din-Rail or wall mounting or desktop

1.4 Dimensions

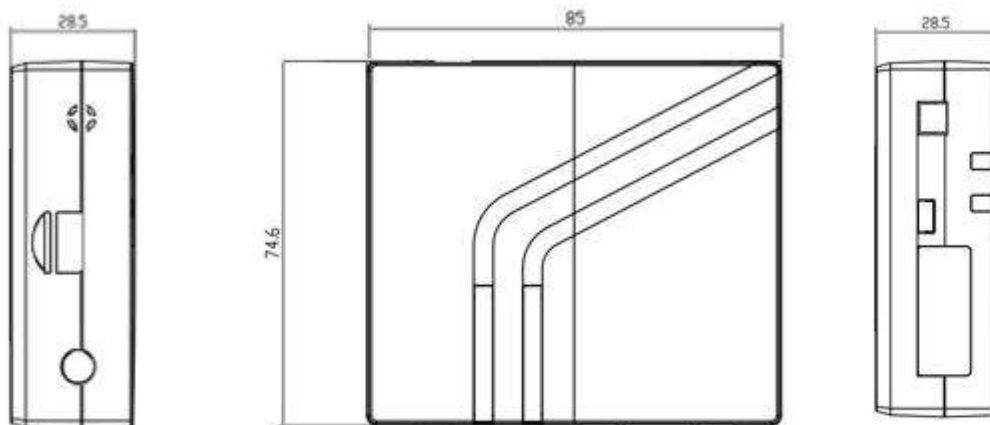

1.5 Selection and Ordering Data

Please refer to corresponding M1000 XP datasheet.

Chapter 2. Installation

2.1 Overview

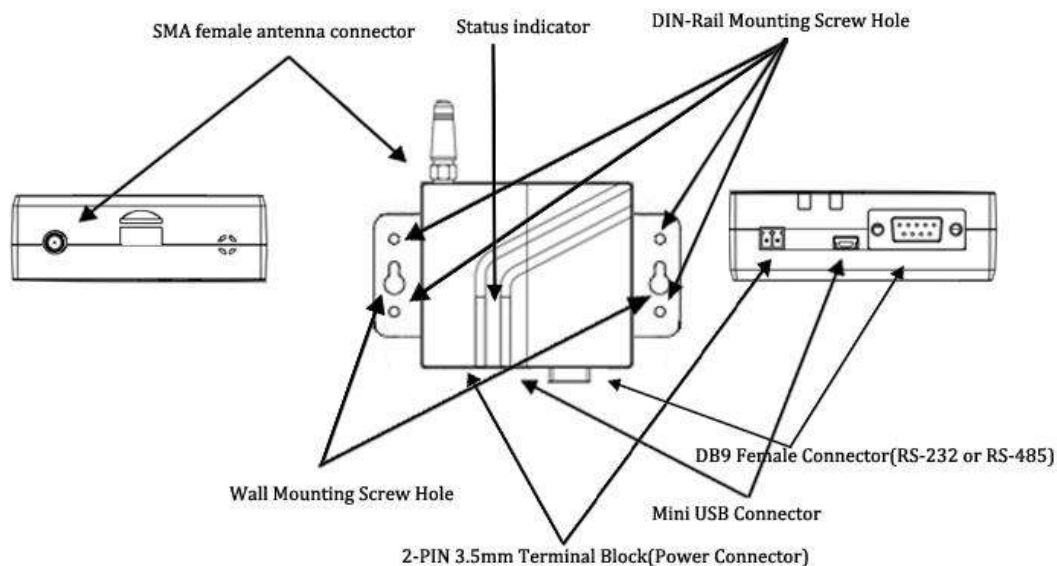

2.2 LED Indicators



Name	Color	Status	Description
RUN	Green	Blinking every 0.5s	System is booting.
		Blinking every 1s	System is running normally but without any GSM/GPRS/UMTS connection.
	Yellow	Blinking every 0.5s	Wireless re-initialization.
		Blinking every 1s	GPRS connection established.
	RED	Blinking every 0.5s	System is running abnormally.

Name	Color	Status	Function
RSSI	None	Off	Searching for network.
	Green	On	Perfect signal quality.
		Blinking every 0.5s	Wireless module communication error, no AT command response.
	Yellow	On	Average signal (GSM/GPRS/UMTS connections)
		Blinking every 1 s	System is configuring via USB, and DB9 serial port is disabled at the same time
		Blinking every 0.5 s	Cannot register to network.
	RED	On	Exceptional signal (GSM/GPRS/UMTS connections)
		Blinking every 0.5s	SIM card detection is fail or PIN error.

2.3 PIN assignment

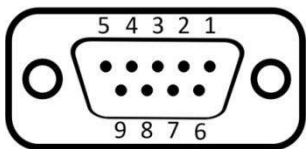

DB9 Female Connector

PIN	RS232	RS485 (2-wire)	Direction
1		Data+ (A)	-
2	RXD		M1000 XP → Device
3	TXD		Device → M1000 XP
4			-
5	GND		-
6		Data- (B)	-
7	RTS		Device → M1000 XP
8	CTS		M1000 XP → Device
9	+5V Output		-

2.4 USB interface

USB interface can be used for configuration, firmware upgrade and power supply. When USB interface of M1000 XP is used for configuration as well as power supply, current/voltage output of USB interface which connects to M1000 XP's USB interface shall at least reach to 1A/5V.

Note: Normally, current/voltage output of laptop's USB 2.0 interface is only 0.5A/5V. So when you use USB interface for configuration, you should use power input interface for power supply (please check section 2.9 错误!未找到引用源。).

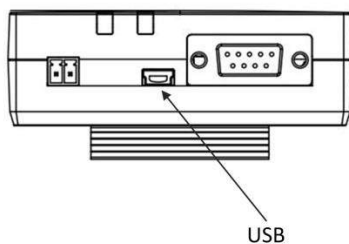

2.5 Install SIM Card

Be sure to insert a SIM card before you use the gateway.

Note: A SIM card set with PIN code cannot be used normally in the gateway without the correct PIN code.

Make sure to disconnect the adapter and switch off your gateway before inserting or removing your SIM/USIM card.



■ Inserting SIM Card

1. Make sure your adapter is disconnected.
2. Insert the SIM card, and you need press the SIM card with your fingers until you hear “a cracking sound”.

■ Removing SIM card

1. Make sure your adapter is disconnected.
2. Press the SIM card until you hear “a cracking sound”, then the SIM card will pop up to be pulled out.

Note:

1. Don't touch the metal surface of the SIM card in case information in the card is lost or destroyed.
2. Don't bend or scratch your SIM card. Keep the card away from electricity and magnetism.
3. Make sure to disconnect the power source from your gateway before inserting and removing your SIM card.



2.6 Connect the External Antenna (SMA Type)

Connect this to an external antenna with SMA male connector. Make sure the antenna is for the correct frequency as your GSM/GPRS/UMTS operator with impedance of 50ohm, and also connector is secured tightly.

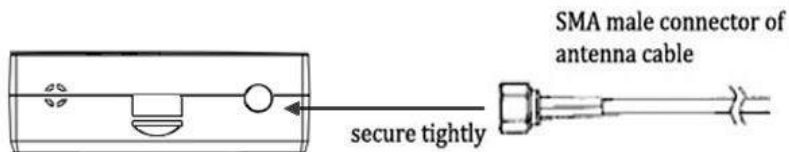

2.7 Connect the Gateway to External Device

User can use the serial cable to connect the gateway's DB9 female connector to external controller / computer.

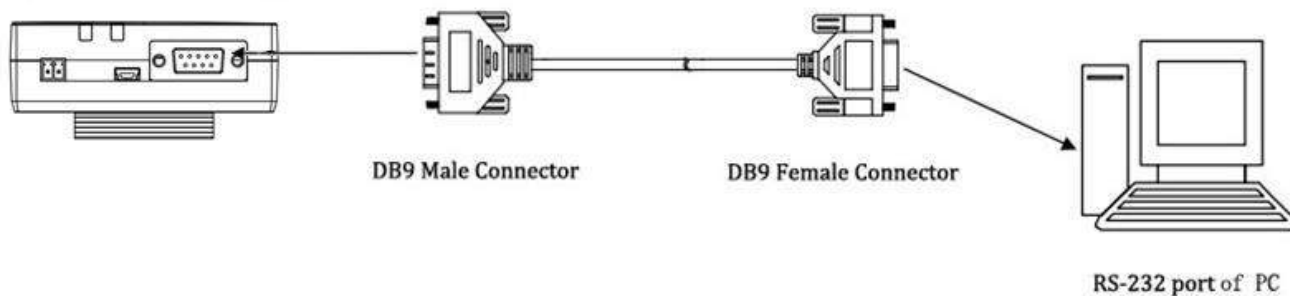

User can use the USB cable to connect the gateway's Mini USB Connector to external controller / computer.

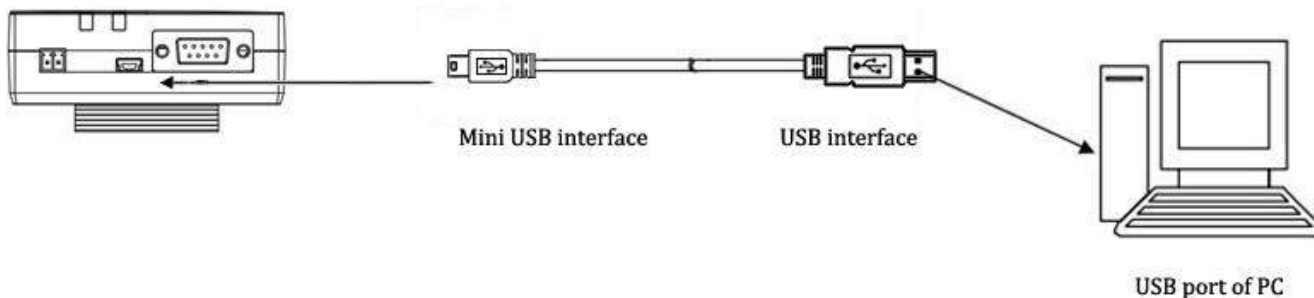

2.8 Mount the Gateway

Use 2 pcs of M3 screw to mount the gateway on the wall.

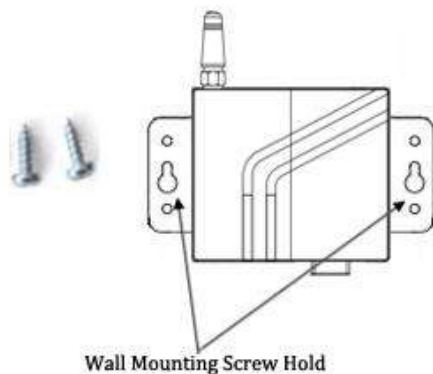

Or to mount the gateway on a DIN rail, you need three pcs of M3 screws.



2.9 Power Supply

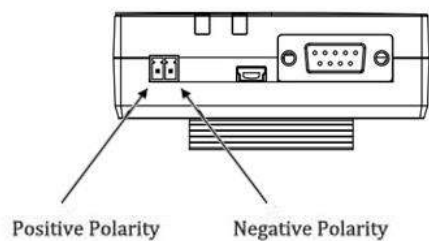

The power supply range is 6 to 18 VDC.

Note: Please take care about the polarity, and do not make reverse connection.

Chapter 3. Operate the Gateway

3.1 M1000 XP Configurator Overview

M1000 XP Configurator is a PC-based configuration software tool for managing and configuring Robustel M1000 XP gateways. With a full graphics mode and Windows-based environment, even first time users will find it easy to learn how to use this new software tool.

M1000 XP Configurator not only makes configuration easier, but also makes it convenient to carry out “mass deployment” and “pre-configuration”. The most important benefits of using the “M1000 XP Configurator” utility are:

1. Green software, no need installation;
2. Full graphics mode, easy to learn how to configure the M1000 XP gateways;
3. The configuration profile can be easily stored, and then replicated to other gateways;
4. Easy to upgrade gateway firmware.

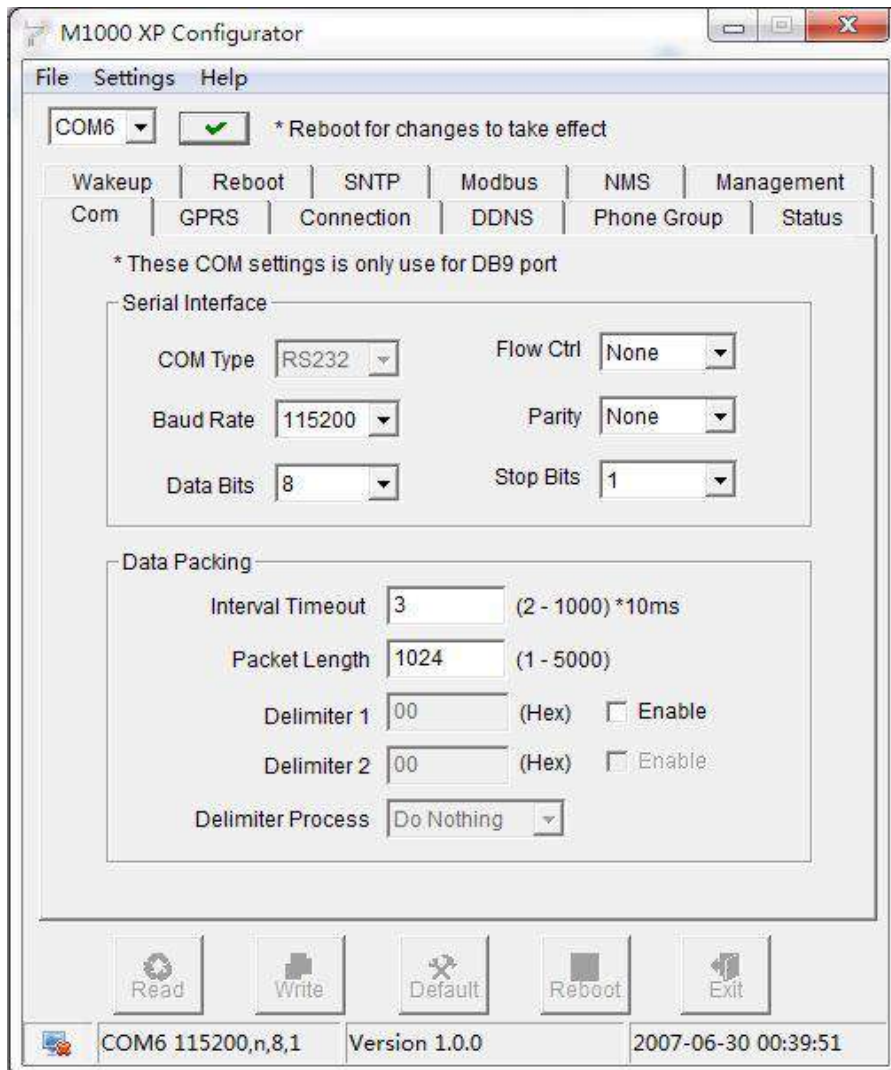

Note: M1000 XP Configurator can be used with Windows 2000/XP/Vista/7 32/64-bit operation systems. If there is any

running issue, for example, the Configurator run normally in Win 7 system but fail to run in Windows XP system, please search "Microsoft Visual C++ 2008 Redistributable Package" to download relevant patch and then install the patch.

3.2 Management via RS-232/USB port

1. Connect the RS-232 port or Mini USB port of the gateway to a host PC, and then power on the gateway.
2. Double click "M1000 XP Configurator.exe" to start the software.



3. Select correct COM port, then click  button. After that you can see the popup windows "Operation Succeed".



Note:

1. The RS-232 connector uses standard PINOUT. A direct male DB9 to female DB9 cable can be used to connect to a PC's serial port.
2. For the PC which connects to M1000 XP's USB port at the first time, user needs to install the serial to USB driver in it. The driver can be found in the attached CD.

3.3 Management via TCP connection

1. Double click "M1000 XP Configurator.exe" to start the software.



- Go to tab “Settings” -> “Communication”.

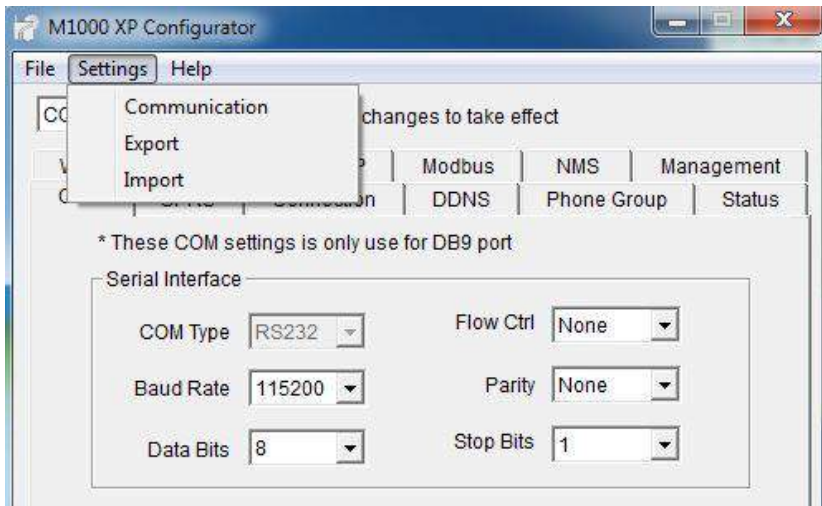

- Select “TCP” interface and the correct mode in the drop down boxes, and enter the local TCP port. If you choose client mode, you need to enter the remote gateway’s IP address. Then click “OK”.

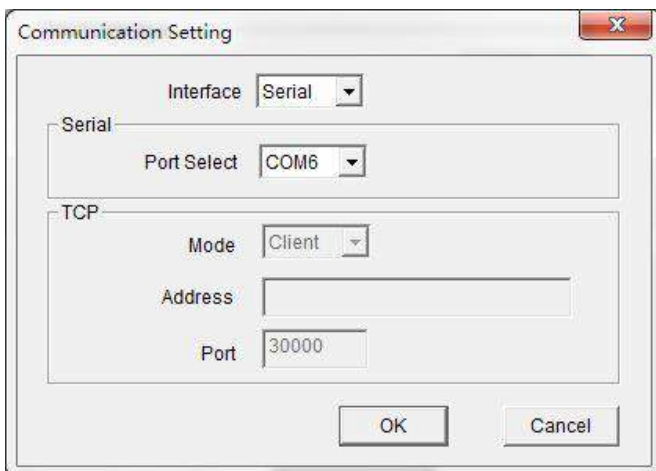

Note:







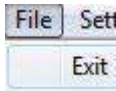
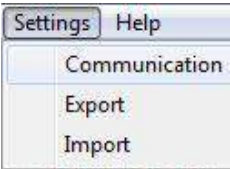
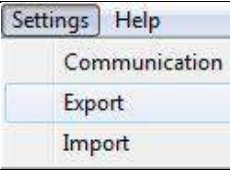
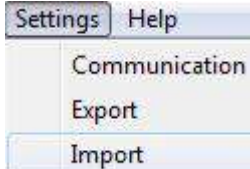
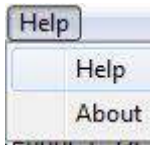
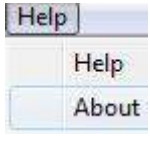
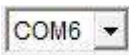

- If you choose TCP client mode, the configurator will establish a TCP connection to the remote gateway which works as TCP server.
- If you choose TCP server mode, the configurator will be in listening status. Then you need to send an SMS to the remote gateway to trigger it to establish a TCP connection with configurator. The form of the SMS is : “nms, configurator’s IP address, configurator’s TCP port” For example, nms 120.12.23.45 50000.
- The NMS function of gateway must have been enabled. Please refer to section **3.16 NMS**
- The cell phone’s number must be included in gateway’s phonebook.

- Click  button. After that you can see the popup windows "Operation Succeed".



3.4 Operation Area Introduction

Menu	Icon	Description
File->Exit		Exit the M1000 XP Configurator.
settings->Communication		Set the communication ways of configurator: Serial or TCP.
Settings->Export		Export the gateway's current configuration file to your local PC.
Settings->Import		Import the gateway's configuration file from local PC to the gateway.
Help->About		Show some notices about this configurator.
Help->About		Manufacturer's information and Gateway configurator version.
Port No.		Select the local RS-232 port to communicate with the gateway.

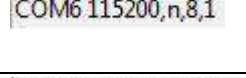
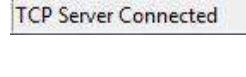
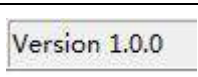
Connect		Connect the M1000 XP Configurator to the gateway, which will use the PC's local RS-232 port.
Disconnect		Disconnect the M1000 XP Configurator to the gateway and release the PC's RS-232 port.
Read		Read gateway's current settings.
Write		Save changes into gateway. Note: Some parameters changes need to reboot to take effect.
Default		Set gateway to default factory settings.
Reboot		Reboot the gateway.
Exit		Exit the M1000 XP Configurator.
Disconnecting		Gateway is not communicating with M1000 XP Configurator.
Connecting		Gateway is communicating with M1000 XP Configurator.
Serial Management Settings		Show the current RS-232 management communication parameter.
TCP Management Settings		Show the current TCP management communication parameter.
Versions		Show the gateway's current firmware version.

Important Notice

You must save your parameter changes by clicking “Write” button and then reboot your M1000 XP by clicking “Reboot” button to take effect for the parameter changes.

3.5 Export and Import Profiles

Users could export gateway settings from one gateway, and then import the same settings to other gateways, which makes it convenient to carry out “mass deployment” and “pre-configuration”.

1. Select **Export** from the **Settings** menu. Then select a folder and enter the file name for the profile. Click on **Save**, then it will popup “**Export Succeed**” windows.

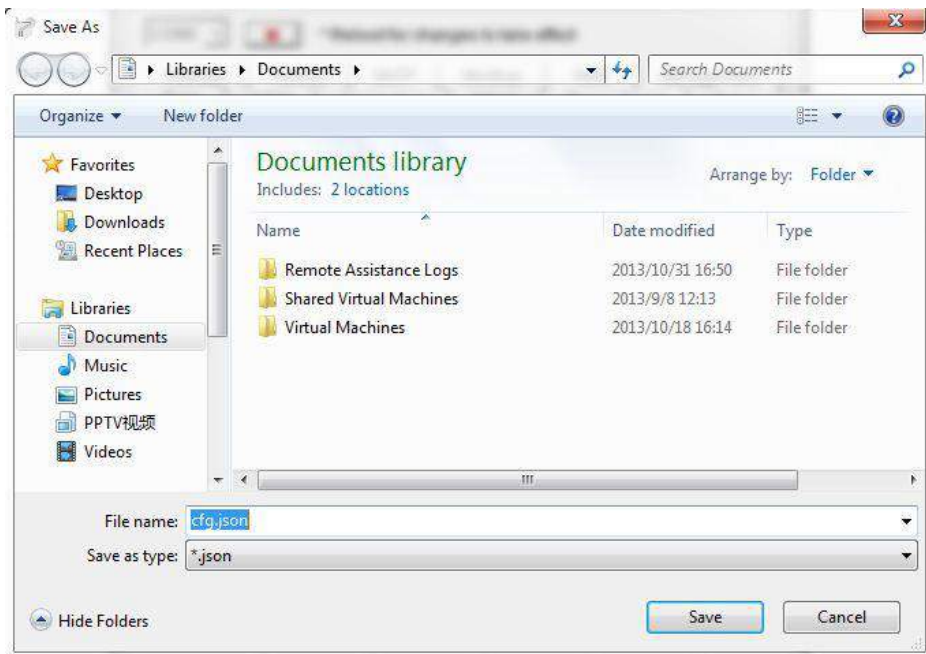
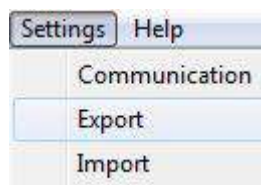

2. Select **Import** from the **Settings** menu. Then select a profile. Click on **Open**.

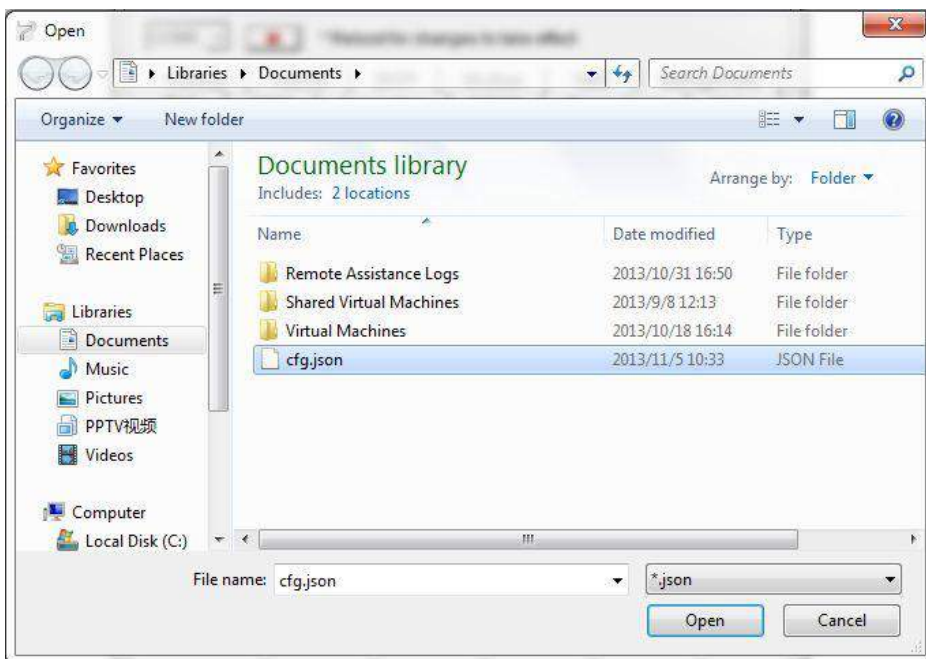
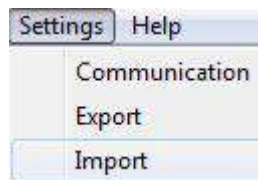

3. Click **“Write”** button then it will popup **“Import Succeed”** windows.

3.6 COM

This tab allows user to set the parameters of serial com port.

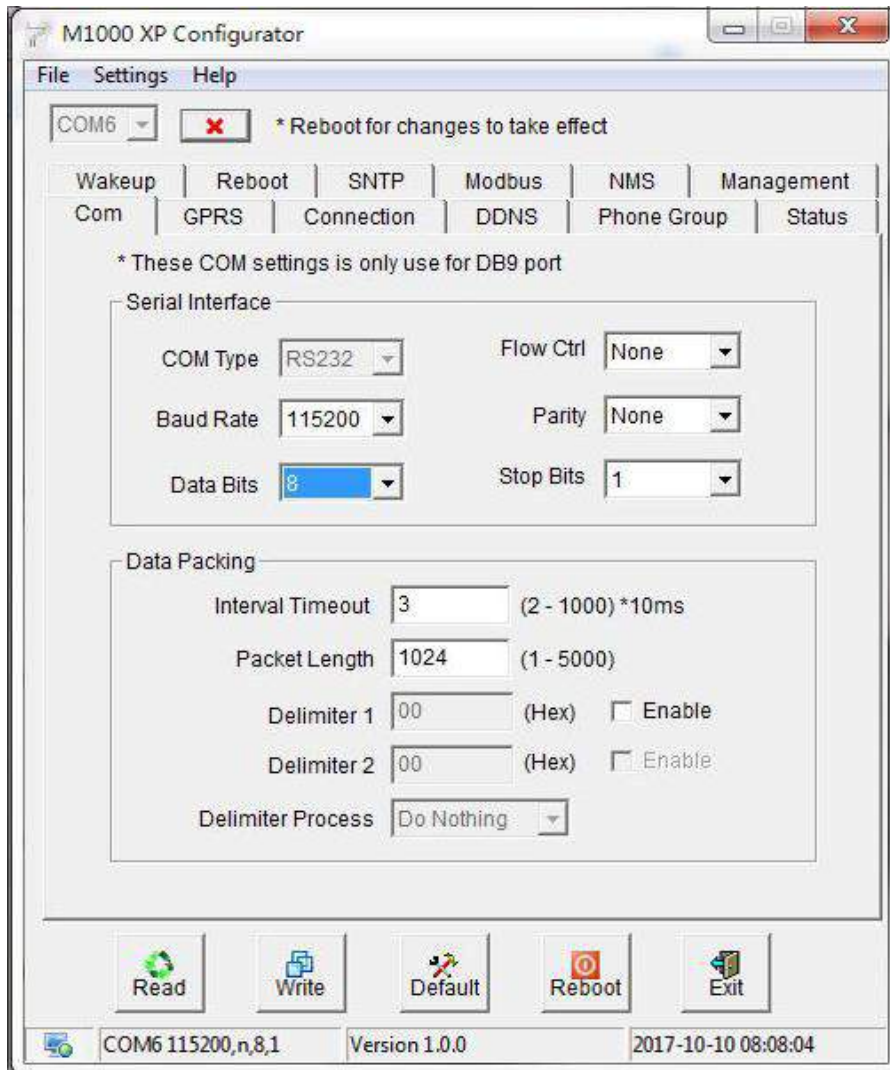

Basic		
Item	Description	Default
COM Type	Show current COM type: “RS232” or “RS485”.	RS232 or RS485
Baud Rate	Select from “1200”, “2400”, “4800”, “9600”, “19200”, “38400”, “57600” and “115200”.	115200
Data Bits	Select from “7” and “8”.	8
Flow Ctrl	Select from “None” and “Hardware”.	None
Parity	Select from “None”, “Odd”, “Even”, “Mark” and “Space”.	None
Stop Bits	Select from “1” and “2”.	1

Interval Timeout	This value allows gateway to packet the received data as a TCP/UDP packet and sends it out even the size of them hasn't reached the limit of <i>Packet Length</i> .	3
Packet Length	The limits size of the received data that gateway will packet as a TCP/UDP packet.	1024
Delimiter	The delimiter indicate gateway to packet the received data as a TCP/UDP packet and sends it out even the size of them hasn't reached the limit of <i>Packet Length</i> .	00
Delimiter Process	Select from "Do Nothing" and "Strip Delimiter".	Do Nothing

3.7 GPRS

The major difference between M1000 XP serial to GSM/GPRS/UMTS gateway and traditional modem such as M1000/M1000 Lite is that M1000 XP built-in PPP and TCP/IP protocols, supports automatic GSM/GPRS/UMTS connection, no AT commands required, which can enable transparent TCP/UDP transmission.

Traditional GPRS gateway can only dialup to internet via external PPP enabled host device such as PC, PLC with built-in PPP protocol.

This tab allows user to set GPRS/UMTS and related items for automatic GPRS/UMTS connection:

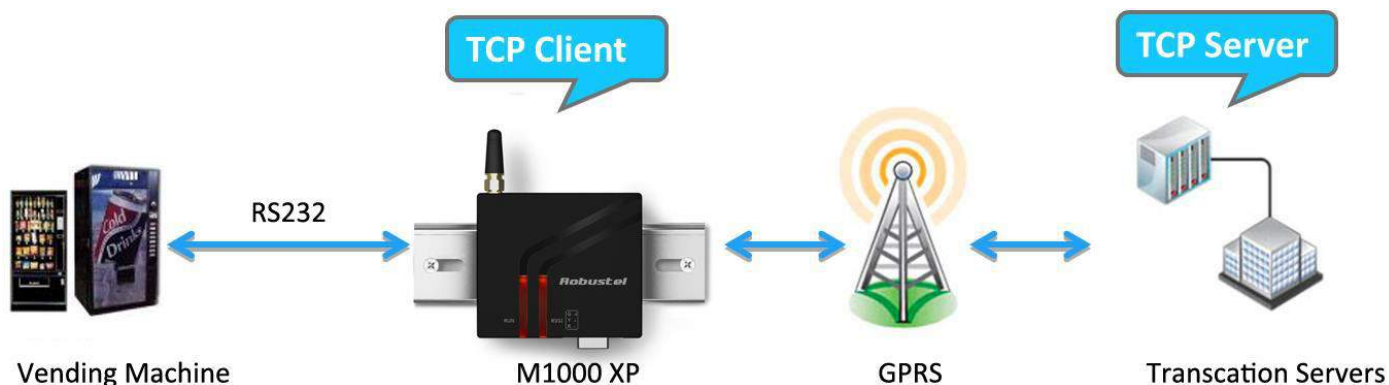

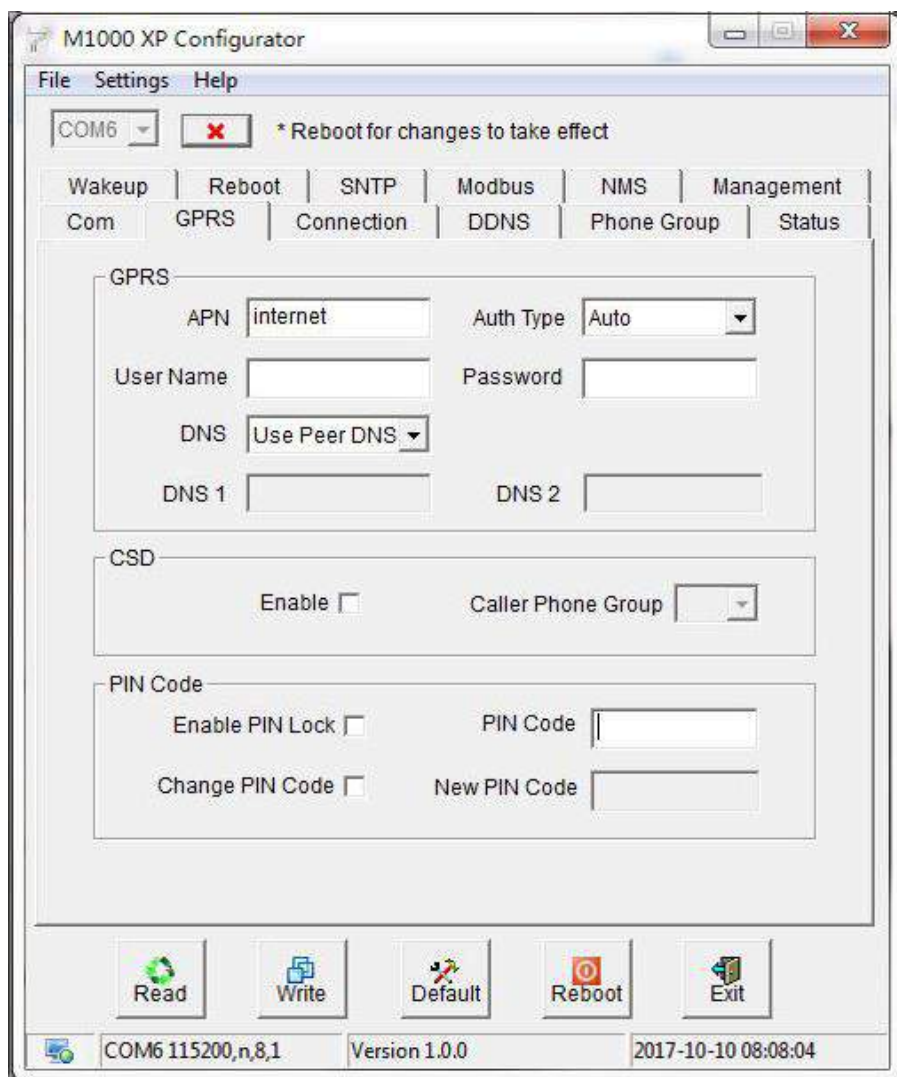

GPRS		
Item	Description	Default
APN	Access Point Name for cellular dial-up connection, provided by local ISP.	internet
Auth Type	Selected from "None", "Auto", "PAP" and "CHAP" as the local ISP required.	Auto
User Name	User Name for cellular dial-up connection, provided by local ISP.	Null
Password	Password for cellular dial-up connection, provided by local ISP.	Null
DNS	Selected from "Use Peer DNS" and "Manual". Use Peer DNS: to automatically have DNS server assigned from local ISP. Manual: input DNS server's IP address manually in DNS 1 and DNS 2 field.	Use Peer DNS
DNS 1	Input DNS server's IP address after enable DNS->Manual.	Disable
DNS 2	Input secondary DNS server's IP address after enable DNS->Manual.	Disable
Enable CSD @	Click to enable CSD feature.	Disable
Caller Phone Group @ CSD	Gateway will only receive CSD call from specific phone numbers which are authorized in this Phone Group.	Null

<p>PIN Code</p>	<p>Select from “Disable PIN Lock” and “Enable PIN Lock”. After enable PIN lock, user could input your SIM’s PIN and store the current PIN in its memory, and then enter the PIN automatically each time the system boots up. <i>Note: Please ask your local GSM ISP to see whether your SIM card require PIN or not.</i> If user wants to change the SIM PIN, please tick the “Change PIN Code” checkbox to enable it, and then input the new PIN at “Input New PIN Code”. The PIN will be changed after reboot.</p>	<p>Disable</p>
-----------------	---	----------------

3.8 Connection

This tab allows user to set the TCP/UDP connections and other related parameters.

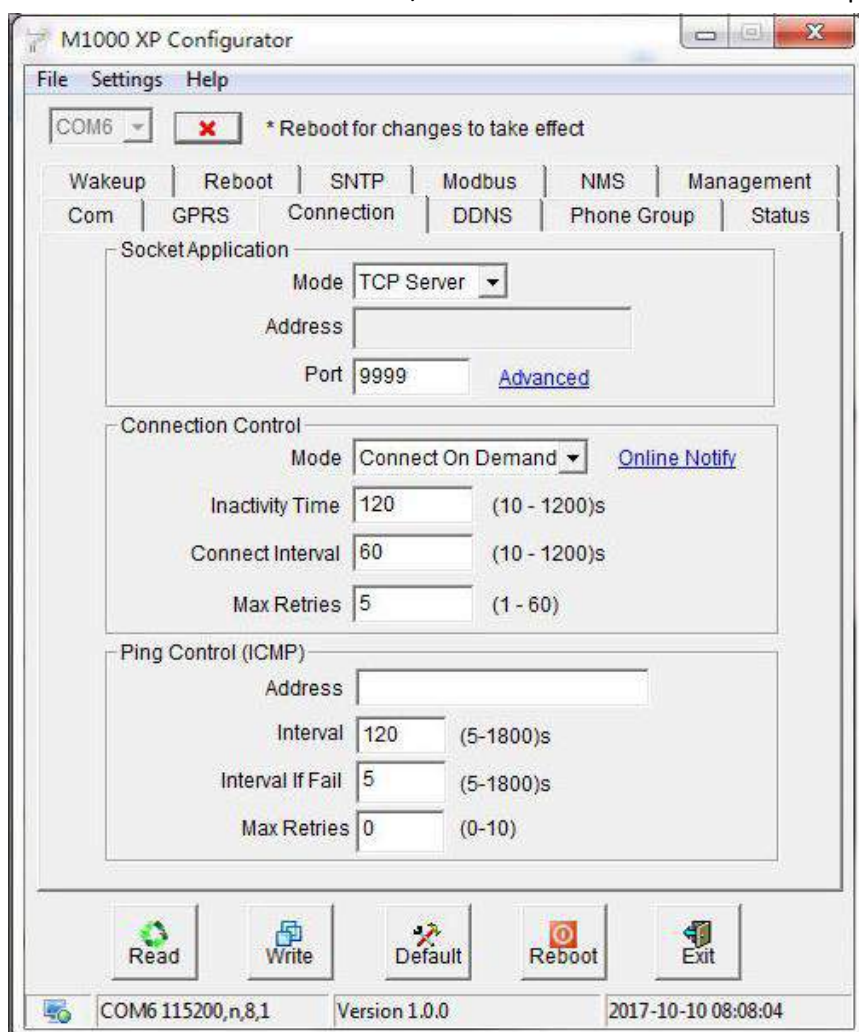

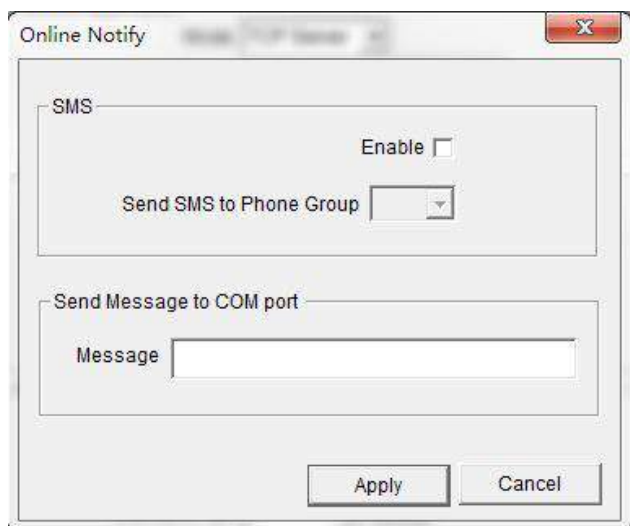
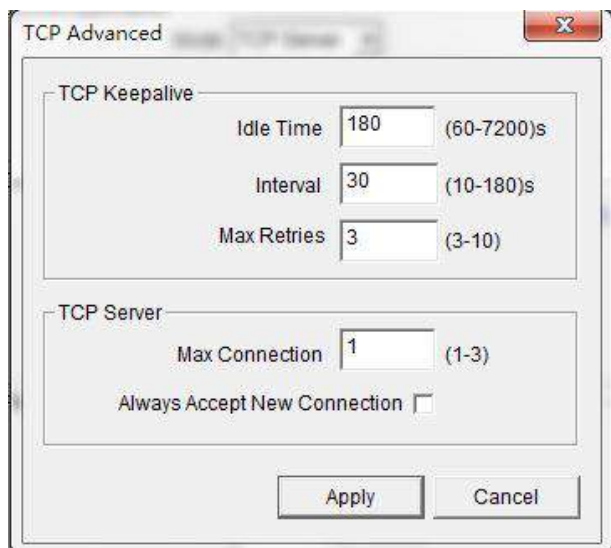

Connection		
Item	Description	Default
Mode @ Socket Application	Selected from "TCP Client", "TCP Server" and "UDP". TCP Client: Gateway works as TCP client, initiate TCP connection to TCP server, the server address supports both IP and domain name. TCP Server: Gateway works as TCP server, listening for connection request from TCP client. UDP: Gateway works as UDP client.	TCP Server
Address @ Socket Application	When gateway works as TCP client, user should input peer TCP server's IP or domain in this item. When gateway works as TCP server, this item is unavailable. When gateway works as UDP client, user should input peer UDP server's IP or domain in this item.	null
Port	When gateway works as TCP client, user should input peer TCP server's port in this item. When gateway works as TCP server, user should input TCP server's listening port in this	9999

	<p>item.</p> <p>When gateway works as UDP client, user should input peer UDP server's port in this item.</p>	
Advanced @ Socket Application	Click to set advanced settings of "Socket Application".	null
Idle Time	<p>Whether gateway is set as TCP Client or TCP Server, keepalive feature can be used to detect whether TCP connection is disconnected by sending specific packets in the transport layer.</p> <p>User can set idle timeout interval in this item, gateway will send out keepalive packet if there is no data for more than "Idle Time". "Idle Time" ranges from 60 to 7200 seconds.</p>	180
Interval	Gateway will re-send the keepalive packet with this interval timeout when it doesn't receive respond packets. "Interval" ranges from 10 to 180 seconds.	30
Max Retries	If gateway re-sends keepalive packet continuously for Max Retries times and doesn't receive correct respond packets, it will detect that the TCP connection is disconnected and it try to establish TCP connection again. "Max Retries" ranges from 3 to 10.	3
Max Connection	<p>When gateway is set as TCP Server, it will wait for TCP connection from TCP Client site.</p> <p>If TCP connection from TCP Client reaches to "Max Connection" it will drop a new TCP connection request. "Max Connection" ranges from 1 to 3.</p>	1
Always Accept New Connection	After click to enable this item, M1000 XP will always accept new TCP connection and drop the earliest one at the same time.	Disable
Mode @ Connection Control	<p>Select from "Always Online" and "Connect On Demand".</p> <p>Always Online: Gateway will automatically initiate a GPRS/UMTS connection after power on and each restarts, this will remain and will be re-established after an interruption.</p> <p>Connect On Demand: After select this option, user could configure wakeup at preset time, wakeup by Call, wakeup by SMS, wakeup by local serial port data at Wakeup Tab.</p>	Connect On Demand
Inactivity Time	<p>User could configure this field after setting gateway under Connect On Demand mode, input from 10 to 1200 seconds.</p> <p>This field specifies the idle time setting for GPRS/UMTS auto-disconnection.</p>	120
Connect Interval	Gateway will automatically re-connect with this interval when it fails communicating to peer via TCP or UDP; also gateway will automatically re-dial with this interval if PPP dial up failed. Input from 10 to 1200 seconds.	60
Max Retries @ Connection Control	<p>The maximum retries times for automatically re-connect when gateway fails to dial up, input from 1 to 60.</p> <p>After maximum retries, gateway will reboot the wireless module.</p> <p>When connecting successful, the Max Retries counter will be set to 0.</p>	5
Online Notify	<p>Click to enable Online SMS Notification function, which will send SMS to the phone numbers included in the <i>Phone Group</i> in this tab.</p> <p>Online SMS Notification includes follow information:</p> <p>Name:</p> <p>Reg:</p> <p>RSSI:</p> <p>Operator:</p>	Disable

	Local IP: Time: <i>Note: Local IP is the gateway's IP address assigned by ISP when dial-up to cellular network successful.</i>	
Send Message to COM port	No matter the gateway is configured as "Always Online" mode or "Connect On Demand" mode, it will output a message with this configured string format data to gateway serial port when it has been triggered to establish PPP connection (dial up). Maximum 48 bytes. <i>Note: If need to output a hex format message, user need to add "\x" in front of the message.</i>	Disable
Phone Group	Set the phone group that the online SMS notification sent to.	1
Address @ Ping Control (ICMP)	Gateway will ping this address to check that if the current connectivity is active.	Null
Interval	Set the ping interval time.	120
Interval if Fail	User can shorten the interval time if fail to ping specific IP address.	5
Max Retries @ Ping Control (ICMP)	If gateway ping the preset address timeout continuously for Max Retries time, it will try to re-connect to GPRS/UMTS network. 0 stands for gateway only try to keep ping the address continuously and will do nothing else even timeout every time. It used to keep the connection always activity to avoid ISP shut down the PPP link in a certain idle time.	0

3.9 DDNS

This tab allows user to set the DDNS server and other related parameters.

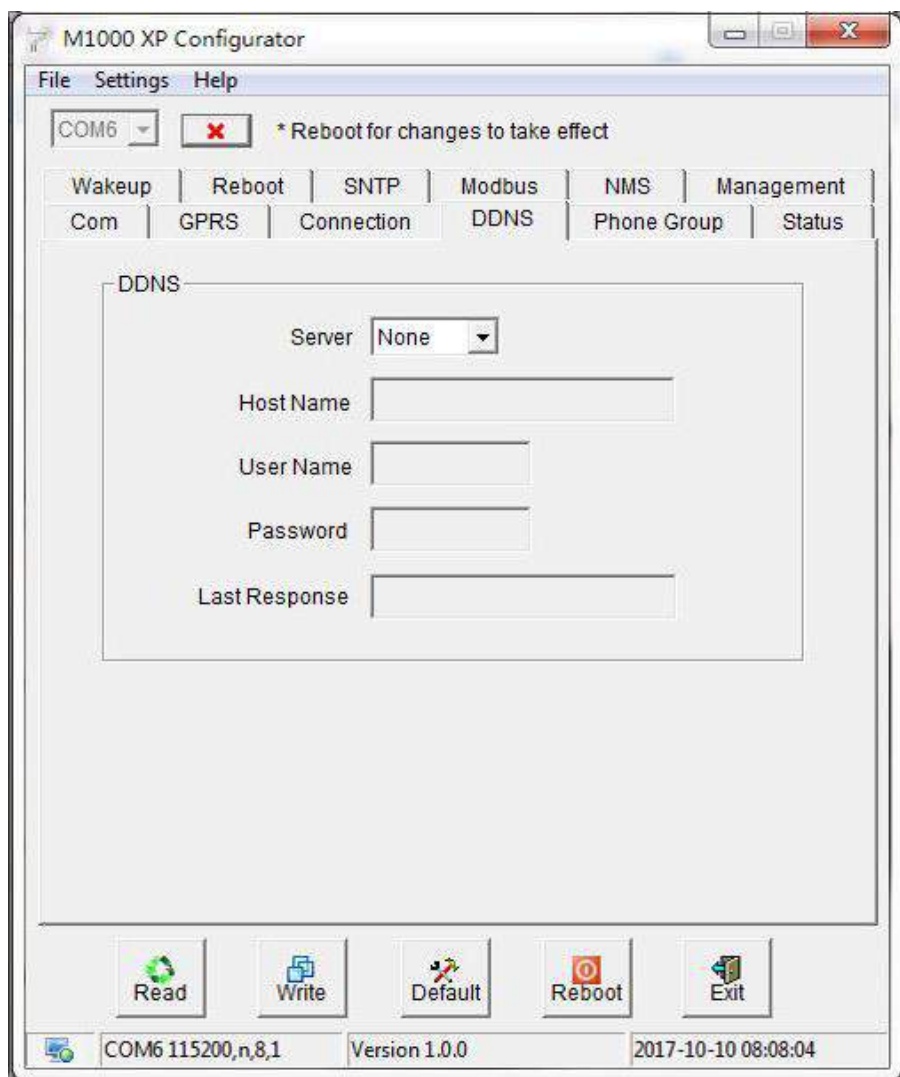

DDNS		
Item	Description	Default
Server	Selected from <i>None</i> , <i>dyndns</i> , <i>3322</i> and <i>No-IP</i> . <i>None</i> : Disable DDNS function. <i>dyndns</i> , <i>3322</i> and <i>No-IP</i> : Corresponding to three DDNS service providers.	None
Host	Enter the Host name the DDNS server provided.	Null
User Name	Enter the user name the DDNS server provided.	Null
Password	Enter password the DDNS server provided.	Null
Last Response	Show the last response from the DDNS server.	Null

3.10 Phone Group

This tab allows user to set the phone numbers and which phone group they are belonged to.

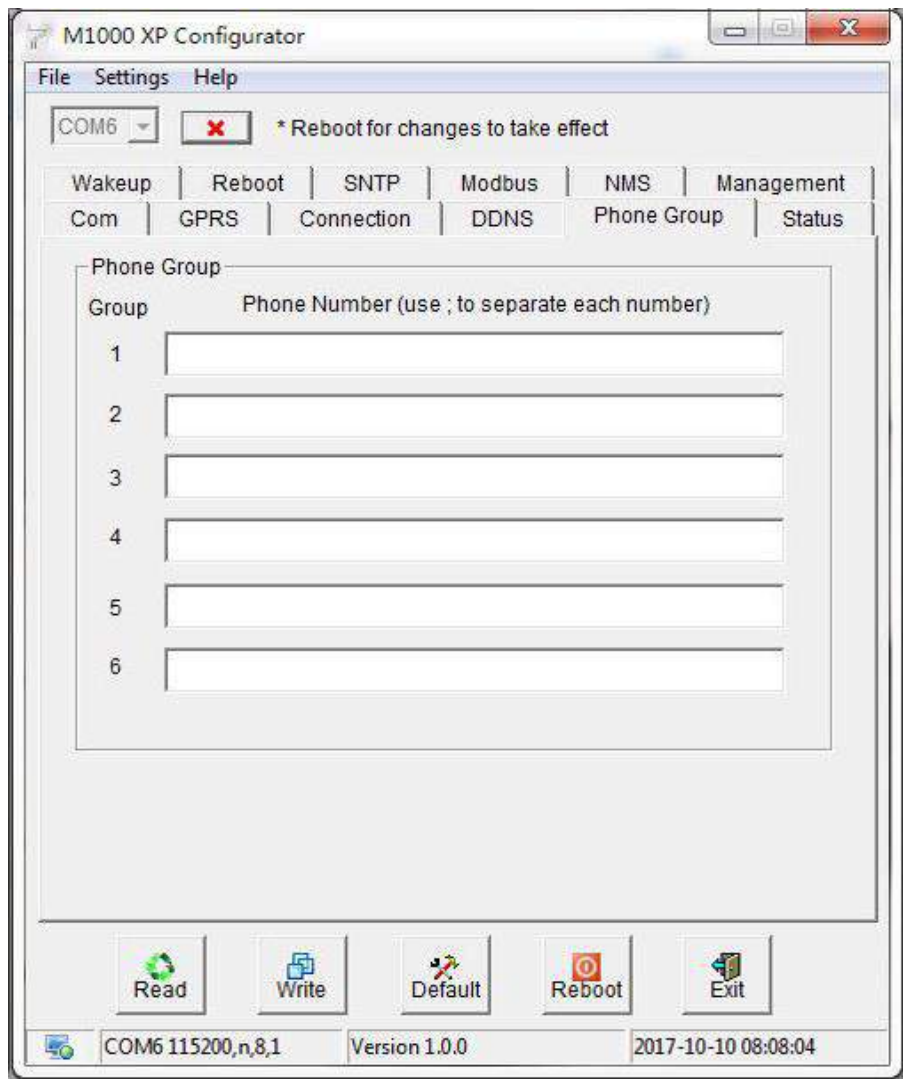

Phone Group		
Item	Description	Default
Phone Group	Input the telephone number in the specify phone group. Maximum 6 phone groups. <i>Note: use punctuation ";" to separate each phone number.</i>	Null
Note: In some countries, the Phone NO. is required to be written in international format, starting with "+" followed by the country code.		

3.11 Status

This tab allows user to check the running status of M1000 XP.

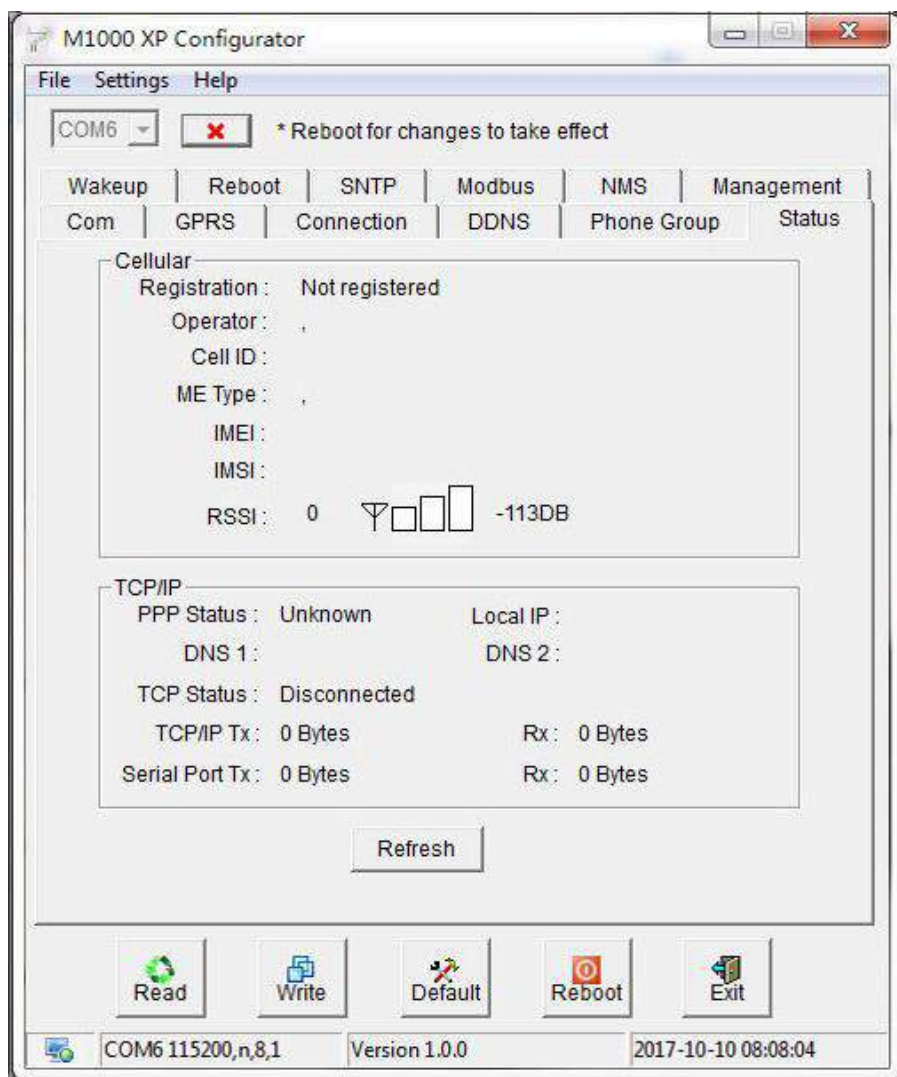

Cellular @ Status

Item	Description	Default
Registration	Show the gateway’s current registration status. There are 6 status: 1. Not registered. 2. Registered to home network. 3. Searching new operator. 4. Registration denied. 5. Registered, roaming. 6. Unknown	N/A
Operator	Show the gateway’s current registered operator name.	N/A
Cell ID	Show the gateway’s current register base station cell ID.	N/A
ME Type	Show the gateway’s current module information.	N/A
IMEI	Show the gateway’s current IMEI number.	N/A
IMSI	Show the gateway’s current IMSI number.	N/A
RSSI	Show the gateway’s current RSSI from 0 to 31 and corresponding DB.	N/A

TCP/IP @ Status		
PPP Status	Show the gateway's current PPP status. There are 4 status: 1. Unknown. 2. Down. 3. Error. 4. Up.	N/A
Local IP	After connecting to GPRS, the gateway will be auto assigned one IP by ISP.	Null
DNS 1	Show the gateway's current primary DNS server.	Null
DNS 2	Show the gateway's current secondary DNS server.	Null
TCP Status	Show the gateway's current PPP status. There are 2 status: 1. Disconnected. 2. Connected	Null
Tx / Rx @ TCP/IP	Show how many bytes have been sent / Received via TCP.	Null
Tx / Rx @ Serial Port	Show how many bytes have been sent / Received via serial port.	Null
Note:		
1. Click "Refresh" to refresh the "Cellular" and "TCP/IP" status.		

3.12 Wakeup

M1000 XP supports various dial-up policies, for example serial data wakeup, wakeup on caller ID, wakeup on SMS and wakeup on preset time of a day.

This tab allows user to set parameters of Wakeup.

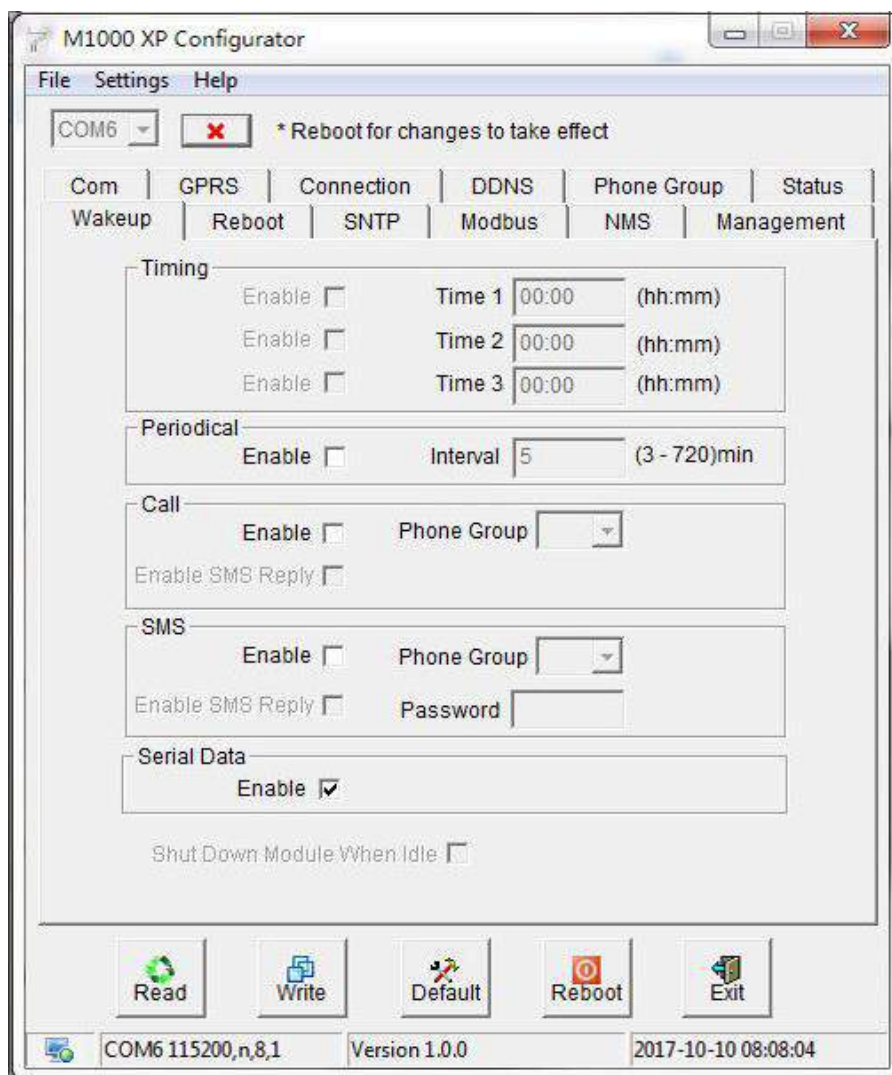

Wakeup		
Item	Description	Default
Time	Tick <i>Enable</i> to allow gateway automatically connects to GPRS/UMTS with preset time schedule every day, support maximum 3 time schedule/day (e.g. 07:00, 11:00 and 23:30 every day).	Disable
Periodical	Tick <i>Enable</i> to allow gateway automatically connects to GPRS/UMTS with preset interval, select from 1 to 1800 minutes. The interval is defined as time interval between two GPRS/UMTS connections.	Disable
Call	Tick <i>Enable</i> to allow gateway automatically connects to GPRS/UMTS with incoming call from specified <i>Caller ID</i> (phone number).	Disable
Phone Group @ Call	Set the Phone Group which was allowed to wake up the gateway by call.	1
Enable SMS Reply @ Call	Tick <i>Enable</i> to allow gateway send reply short message after automatically connects to GPRS/UMTS by Call Wakeup from specified <i>Caller ID</i> (e.g. GPRS on ok!). Note: Only support text format SMS.	Disable

SMS	Tick the <i>SMS</i> checkbox to allow gateway automatic connects to GPRS/UMTS with incoming specified short message from specified <i>Caller ID</i> (phone number). Specified short message is set at <i>Password</i> item. (e.g. GPRS on)	Disable
Phone Group @ SMS	Set the Phone Group which was allowed to wake up the gateway by SMS.	1
Password	The specified short message which was used to wake up the gateway	Null
Enable SMS Reply@ SMS	Tick <i>Enable SMS Reply</i> to allow gateway to send reply short message after automatic connects to GPRS/UMTS by SMS Wakeup from specified <i>Caller ID</i> (e.g. GPRS on ok!). Note: Only support text format SMS.	Disable
Serial Data	Tick <i>Enable</i> to allow gateway automatic connects to GPRS/UMTS from idle mode when there is data (any data) come out from serial port. After gateway has connected to GPRS/UMTS and established TCP connection, the “triggered” data will be sent to destination site.	Enable
Shut Down Module When Idle	Enable to set the gateway to shut down module when connectivity is in idle status. This function only can be configured under <i>Connect On Demand</i> mode.	Disable
Note: 1. Time format for Time reboot is 24-hours. 2. The phone numbers for Call and SMS function can be set in Phone Book tab. 3. In some countries, the Caller ID is required to be written in international format, starting with “+” followed by the country code.		

3.13 Reboot

Since cellular network is not as stable as fixed line, M1000 XP supports various auto reboot function to keep gateway working 24x7 without hang up.

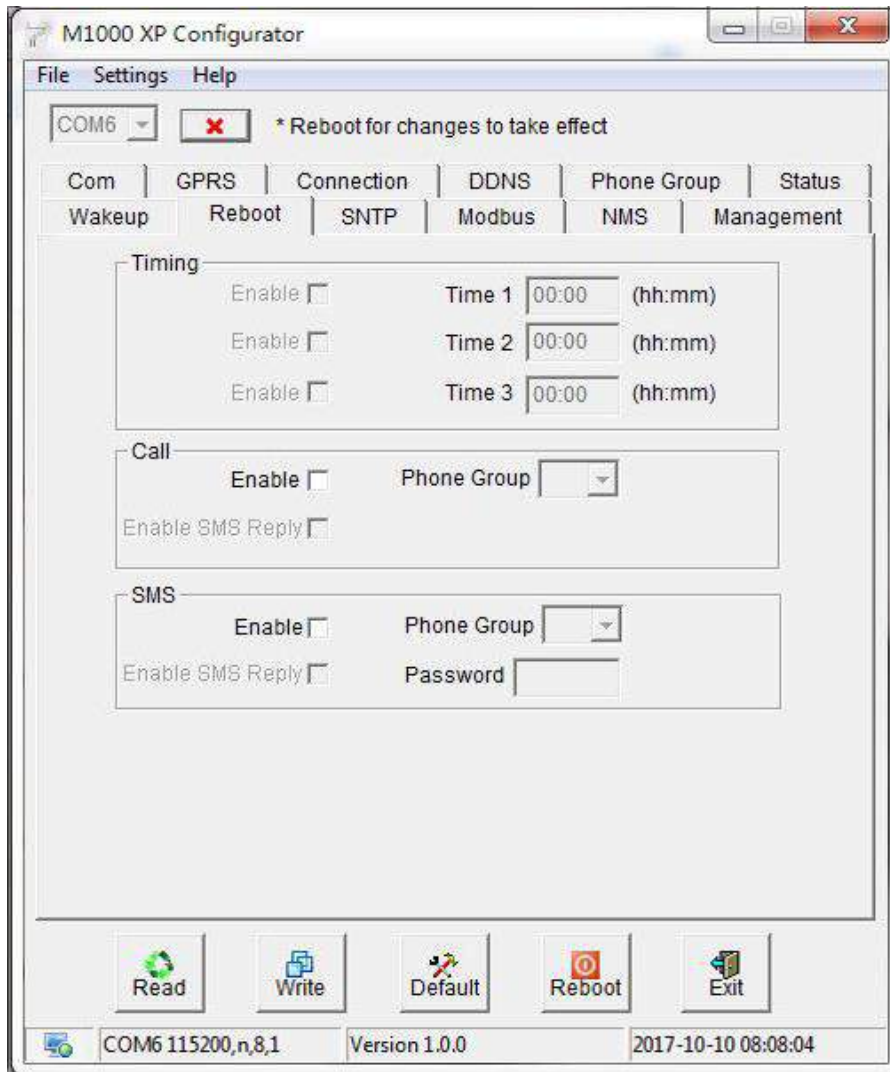

Reboot		
Item	Description	Default
Time	Tick <i>Enable</i> to allow gateway auto reboot with preset time schedule every day, support maximum 3 time schedule/day (e.g. 07:00, 11:00 and 23:30 every day).	Disable
Call	Tick <i>Enable</i> to allow gateway auto reboot with incoming call from specified <i>Caller ID</i> (phone number). The <i>Caller ID</i> (phone number) should be specified in <i>Phone Book</i> tab by inputting the phone number and tick <i>Call Reboot</i> checkbox.	Disable
Phone Group @ Call	Set the Phone Group which was allowed to reboot the gateway by call.	Null
Enable SMS Reply	Tick the <i>Enable SMS Reply</i> checkbox to allow gateway send reply short message after auto reboot by Call Reboot from specified <i>Caller ID</i> (e.g. Reboot ok!). Note: Only support text format SMS.	Disable
SMS	Tick <i>Enable</i> to allow gateway auto reboot with incoming specified	Disable

	short message from specified <i>Caller ID</i> (phone number). Specified short message is set at <i>Password</i> item. (e.g. reboot) The <i>Caller ID</i> (phone number) should be specified in <i>Phone Book</i> tab by inputting the phone number and tick <i>SMS Reboot</i> checkbox.	
Phone Group @ SMS	Set the Phone Group which was allowed to reboot the gateway by SMS.	Null
Enable SMS Reply	Tick the <i>Enable SMS Reply</i> checkbox to allow gateway send reply short message after auto reboot by SMS Reboot from specified <i>Caller ID</i> (e.g. Reboot ok!). Note: Only support text format SMS.	Disable
Password	The specified short message which was used to reboot the gateway	Null
<p>Note:</p> <ol style="list-style-type: none"> 1. Time format for Time reboot is 24-hours. 2. The phone numbers for Call and SMS function can be set in Phone Book tab. 3. In some countries, the Caller ID is required to be written in international format, starting with “+” followed by the country code. 		

3.14 SNTP

SNTP is a networking protocol for clock synchronization between device systems over packet-switched, variable-latency data networks. In this page, user can set up SNTP function.

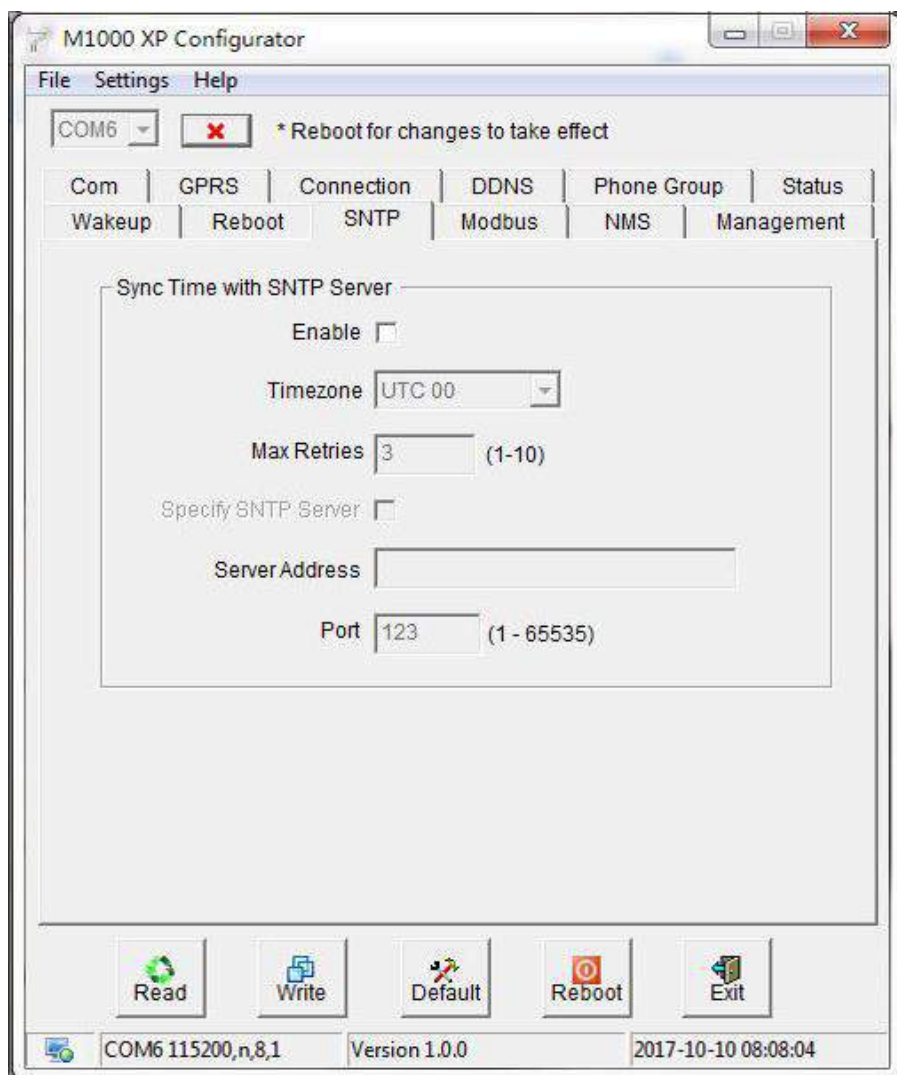

SNTP		
Item	Description	Default
Enable	Click to enable SNTP client which can synchronize the time from NTP server.	Disable
Timezone	A time zone is a region on Earth that has a uniform standard time for legal, commercial, and social purposes. Most of the time zones on land are offset from Coordinated Universal Time (UTC) by a whole number of hours (UTC-12 to UTC+12).	UTC 00
Max Retries	The maximum retries times for automatically re-send SNTP request packet when gateway fails to update. Input from 1 to 10.	3
Specify SNTP Server	Tick the <i>Enable Specify SNTP Server</i>	Disable
Server Address	Input the specify Server Address	Null
Port	User should input peer UDP server's port in this item. Input from 1-65535.	123

3.15 Modbus

This tab allows user to set the related parameters of Modbus RTU to Modbus TCP gateway.

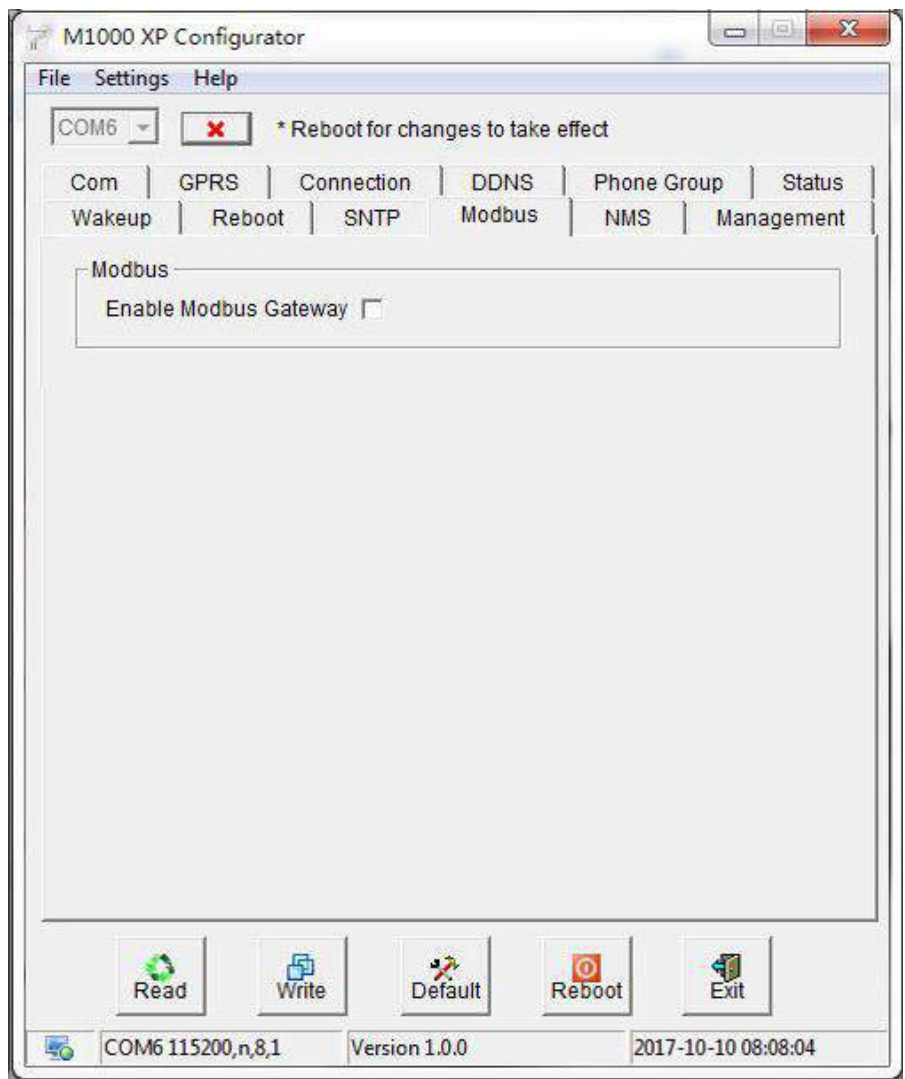

Modbus

Item	Description	Default
Enable Modbus Gateway	Tick this checkbox to enable Modbus RTU to Modbus TCP feature, or via vise.	Disable

3.16 NMS

This tab allows user to set the related parameters of TCP Network Management.

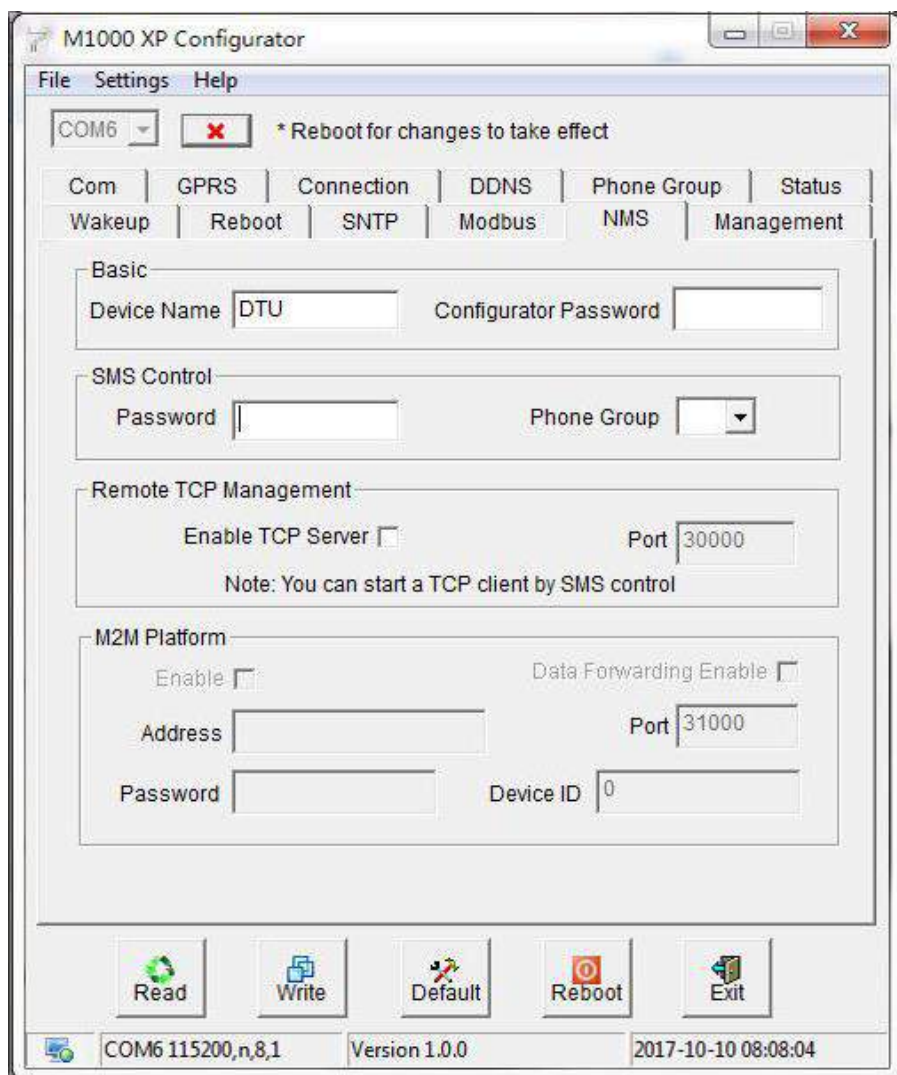

NMS		
Item	Description	Default
Device Name	Write down the description name of the gateway, such as write down the gateway installation site name in order to identify each gateway.	DTU
Configurator Password	Set password for the Configurator. When run M1000 XP Configurator you need to enter this password.	Null
Password @ SMS Control	Password for SMS control, including remote configuration and remote reading gateway status. The password can be left as null, maximum 20 ASCII characters.	Null
Phone Group @ SMS Control	Set the Phone group which is permitted to SMS control this gateway.	Null
Enable TCP Server	Tick this checkbox to enable NMS.	Disable
Port	Set the listening port of TCP server for NMS function.	30000
Enable @ M2M Platform	When click to enable this checkbox, gateway will works as TCP Client site and be managed via RobustLink (Robustel centralized management and administration system).	Disable

Data Forwarding Enable @ M2M Platform	When enable this feature, all serial data from gateway will be forwarded to M2M Platform, will not forward to address that configured in "Connection" -> "Socket Application". At the same time, "Connection" -> "Socket Application" can't be configured. When disable this feature, all serial data from gateway will not be forwarded to M2M Platform, will forward to address that configured in ""Connection" -> "Socket Application". M2M Platform just acts as a remote management platform this time.	Disable
Address @ M2M Platform	Enter IP address or domain of M2M Platform.	Null
Port @ M2M Platform	Enter the port number of M2M Platform.	Null
Password @ M2M Platform	Enter password in this item, which shall be the same as the password set in M2M Platform.	Null
Device ID @ M2M Platform	This item let you know the default single ID of M1000 XP, can't be configured.	N/A

3.17 Management

This tab provides some system tools for user.

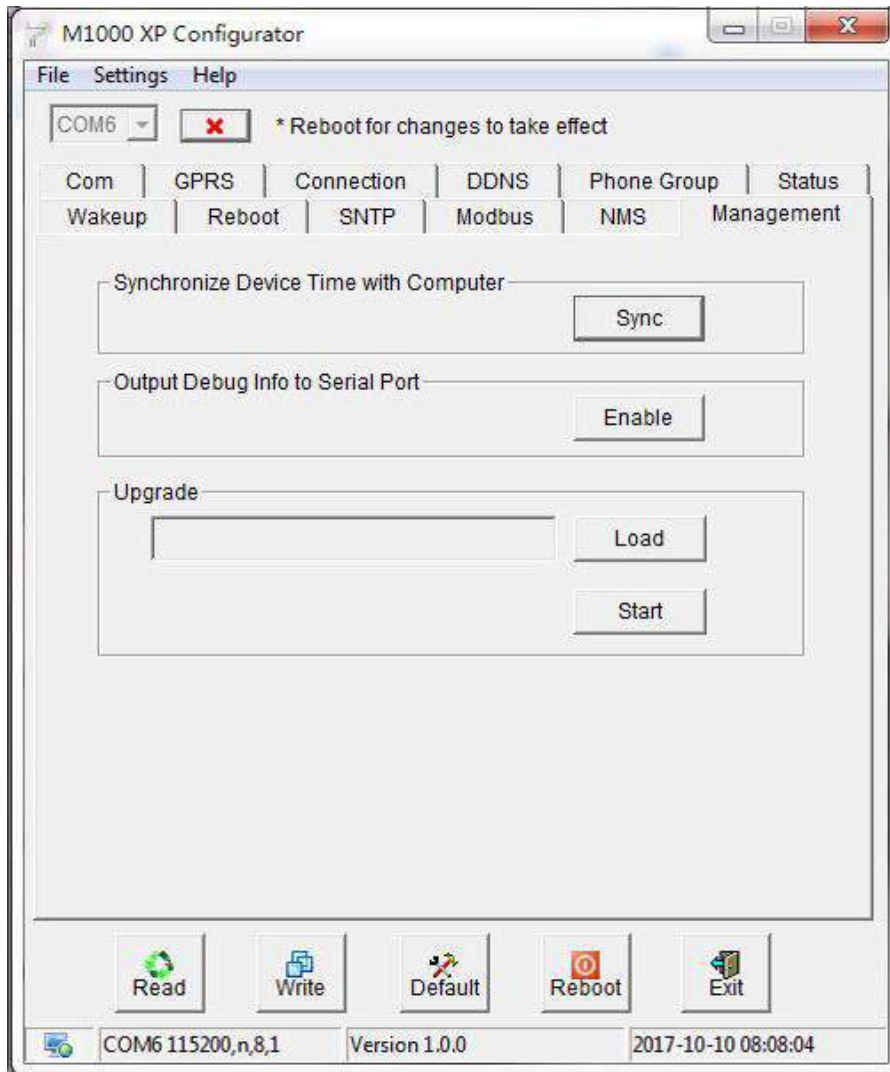

Management		
Item	Description	Default
Synchronize Device Time with Computer	Synchronize gateway's RTC to PC's clock. The gateway's current RTC will be showed at bottom right side of the configurator.	Null
Output Debug info to Serial Port	Enable to output the gateway's debug info to serial port. Then you can use a hyper terminal to receive the debug info. This function is often used when we need to diagnose the problem of the gateway. Note: <i>This function will take effect immediately after you enable it.</i>	Disable
Upgrade	Upgrade the firmware of gateway via serial port or TCP connection. The upgrade steps are as bellow: 1. Click "load" button and select the FW file in your computer; 2. Click "Start" button to get started, then you can see a process bar; 3. The updating will last for several minutes, after that you will see a pop window to indicate the updating is successful.	

Chapter 4. Typical Applications

4.1 Overview

Cellular data transmission is an increasingly attractive mechanism for communication with remote, non-permanent or mobile devices. Being able to collect and distribute data virtually anywhere without requiring the limitation of working within specific fixed line networks is a powerful force for efficiency and reliability. However, the fact that cellular data is metered means that the frequency of transmission and amount of data sent in each exchange can have significant cost and performance impact.

In order to understand this impact, let us start with a fairly typical example, where there is a device in the field and an application on a server at a central site location that collects information from that device.

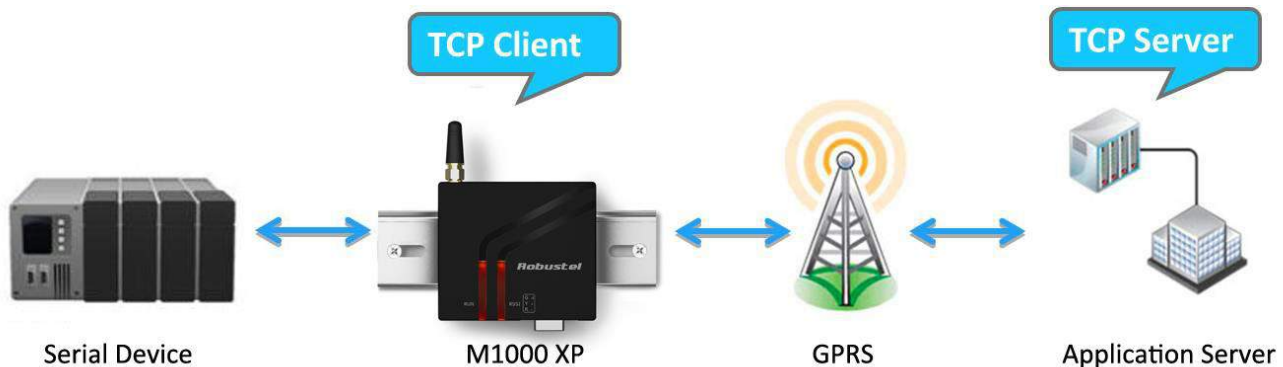

In general, the purpose of communication with the device will be for one of two reasons:

- Monitoring - Status monitoring data, such as the level or temperature of a storage tank, the velocity and pressure of a pipeline, the condition of a controller or the status of a register.
- Transaction data – Discrete event data, such as cash or credit transactions, PBX call records or mission-critical and safety related alarms.

Status monitoring data is often “polled.” The application sends out periodic queries and gets responses to those queries. The application can usually retry if it does not get an answer, and determine that a problem exists if it does not get a response after a certain amount of retries.

Discrete event data is usually “unsolicited.” The application does not expect to get information on any regular basis, and therefore the failure to hear from the device is the normal case (though some sort of “all is well” message may be sent at a longer interval).

Most applications will likely involve one or both of these methods and data is transmitted in TCP or UDP packets.

4.2 Typical Applications

4.2.1 TCP Client Mode

In TCP Client mode, the gateway can actively establish a TCP connection to a pre-defined host computer when serial data arrives. After the data has been transferred, the gateway can automatically disconnect from the TCP server by using the Inactivity time settings.

As illustrated in the figure below, data transmission proceeds as follows:

- (1) The gateway, configured for TCP Client mode, requests a connection to the host.
- (2) Once the connection is established, data can be transmitted in both directions between the host and the gateway bidirectional.

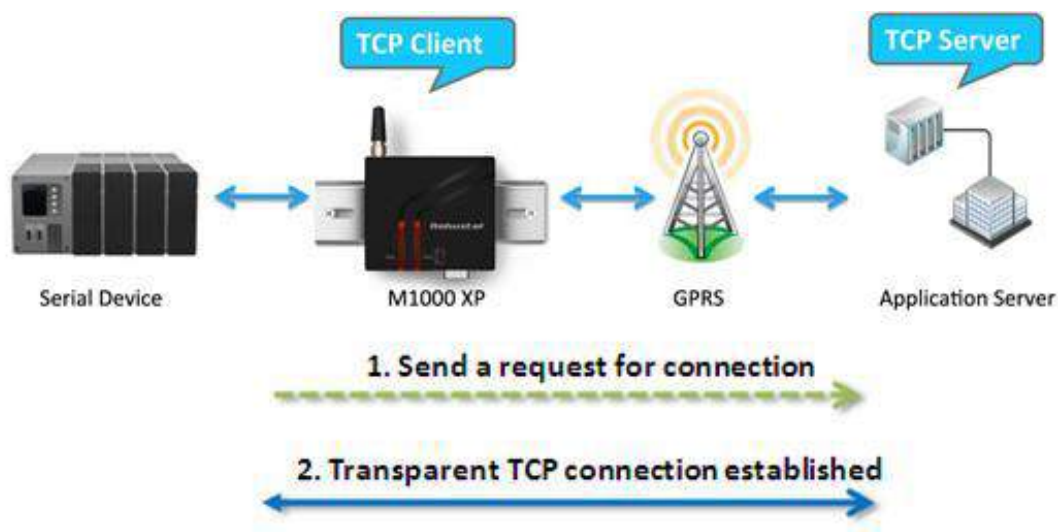

Types of TCP Client Connection:

1. Fixed Public IP (or dynamic public IP with domain name) for the host PC
The gateway will only be able to connect to a host PC if the PC is using a fixed public IP address (or dynamic public IP with domain name), gateway can be any IP (either a private IP or public IP).
2. Connecting TCP client and TCP server within the same cellular service provider.
In order to connect properly, the IP addresses of the two gateways must belong to the same sub network. To ensure that this is the case, use the same cellular ISP to connect the devices to the network. In addition, you will need to request that the cellular ISP provide you with two private fixed IP addresses (e.g., 192.168.1.1 and 192.168.1.2).

Configuration and Operation:

1. Connect gateway to your PC properly.
2. Open the Modem configurator.
3. Turn to *GPRS* tap. Set APN, Username and Password. Then click "Write".

Wakeup	Reboot	SNTP	Modbus	NMS	Management
Com	GPRS	Connection	DDNS	Phone Group	Status

GPRS

APN Auth Type

User Name Password

DNS

DNS 1 DNS 2

CSD

Enable Caller Phone Group

PIN Code

Enable PIN Lock PIN Code

Change PIN Code New PIN Code

4. Turn to *Connection* tap. Select Socket Application Mode as *TCP Client*. Input remote TCP server’s address and port. Select Connection Control Mode as *Always Online* or *Connect On Demand* as your need. Then click “Write” and reboot it.

Wakeup	Reboot	SNTP	Modbus	NMS	Management
Com	GPRS	Connection	DDNS	Phone Group	Status

Socket Application

Mode Address Port [Advanced](#)

Connection Control

Mode [Online Notify](#)

Inactivity Time (10 - 1200)s

Connect Interval (10 - 1200)s

Max Retries (1 - 60)

Ping Control (ICMP)

Address

Interval (5-1800)s

Interval If Fail (5-1800)s

Max Retries (0-10)

4.2.2 TCP Server Mode

In TCP Server mode, the serial port on the gateway is assigned a port number. The host computer initiates contact with the gateway, establishes the connection, and receives data from the serial device.

As illustrated in the figure, data transmission proceeds as follows: The host requests a connection from the gateway, which is configured for TCP Server mode. Once the connection is established, data can be transmitted between the host and the gateway bidirectional.

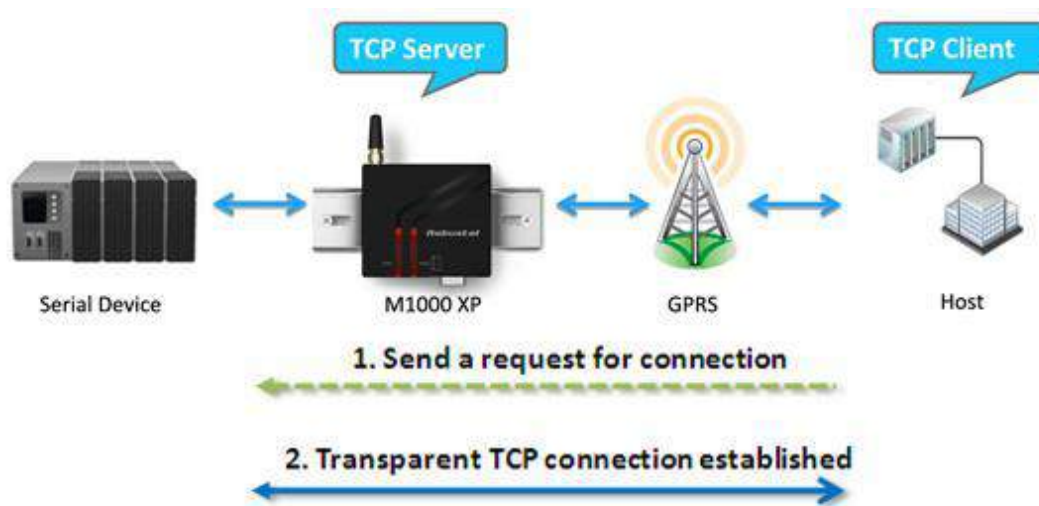

Types of TCP Server Connection:

- Fixed Public IP for the gateway.**
If your cellular service provider offers a fixed public IP address after you connect to the cellular network, you can access the gateway from a host PC using either a private IP or public IP.
- Dynamic public IP with domain name for the gateway.**
If your cellular service provider offers a dynamic public IP address after you connect to the cellular network, you can use the DDNS function to get a domain name from the domain name server for the gateway. Then you can access the gateway from a host PC using this domain name.
- Connecting TCP client and TCP server within the same cellular service provider.**
In order to connect properly, the IP addresses of the two gateway devices must belong to the same sub network. To ensure that this is the case, use the same cellular ISP to connect the devices to the network. In addition, you will need to request that the cellular ISP provide you with two private fixed IP addresses (e.g., 192.168.1.1 and 192.168.1.2).

Configuration and Operation:

1. *Connect gateway to your PC properly.*
2. Open the Modem configurator.
3. Turn to *GPRS* tap. Set APN, Username and Password. Then click *"Write"*.

Wakeup	Reboot	SNTP	Modbus	NMS	Management
Com	GPRS	Connection	DDNS	Phone Group	Status

GPRS

APN Auth Type

User Name Password

DNS

DNS 1 DNS 2

CSD

Enable Caller Phone Group

PIN Code

Enable PIN Lock PIN Code

Change PIN Code New PIN Code

- Turn to *Connection* tap. Select Socket Application Mode as *TCP Server*. Input local listening port. Select Connection Control Mode as *Always Online* or *Connect On Demand* as your need. Then click "Write" and reboot it.

Wakeup	Reboot	SNTP	Modbus	NMS	Management
Com	GPRS	Connection	DDNS	Phone Group	Status

Socket Application

Mode

Address

Port [Advanced](#)

Connection Control

Mode [Online Notifv](#)

Inactivity Time (10 - 1200)s

Connect Interval (10 - 1200)s

Max Retries (1 - 60)

Ping Control (ICMP)

Address

Interval (5-1800)s

Interval If Fail (5-1800)s

Max Retries (0-10)

4.2.3 UDP Mode

The main difference between the TCP and UDP protocols is that TCP guarantees delivery of data by requiring the recipient to send an acknowledgement to the sender. UDP does not require this type of verification, making it possible to offer faster delivery. UDP also allows you to unicast data to one IP, or multicast the data to a group of IP addresses.

These traits make UDP mode especially well-suited for message display applications.

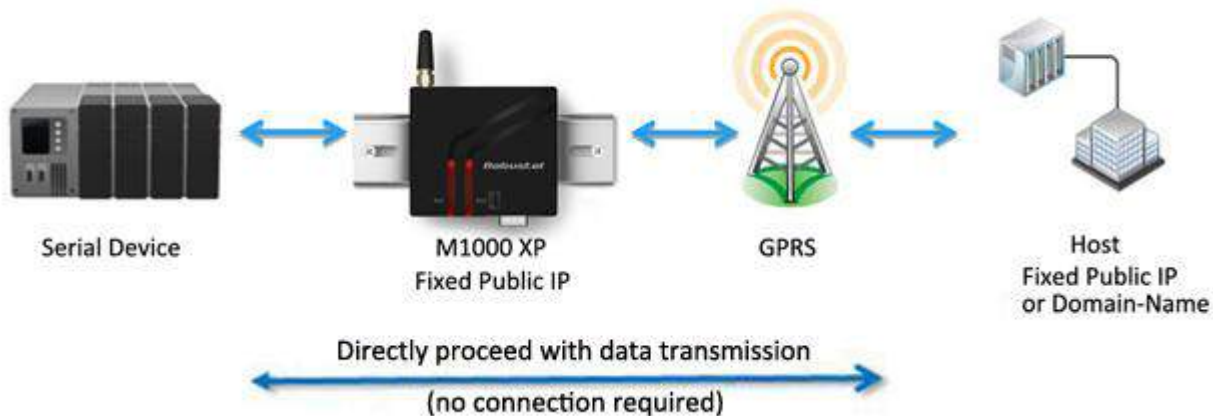

1. If your cellular ISP offers a fixed public IP address after you connect to the cellular network, you can access the gateway from a host PC that has a fixed public IP bidirectional.
2. If your cellular service provider offers a dynamic public IP address after you connect to the cellular network, you can use the DDNS function to get a domain name from the domain name server for the gateway. Then you can access the gateway from a host PC that has a fixed public IP bidirectional.
3. If gateway has no fixed public IP or domain name, then it can unicast data to one host unidirectional.

Note: M1000 XP supports unicast only.

4.2.4 Virtual COM Mode

One of the major conveniences of using Virtual COM mode is that it allows you to use Virtual COM software that was written for pure serial communication applications. The Virtual COM driver intercepts data sent to the host's COM port, packs it into a TCP/IP packet, and then redirects it through the host's Ethernet to the Internet. At the other end of the connection, the gateway accepts the IP frame from the cellular network, unpacks the TCP/IP packet, and then transparently sends the data through the serial port to the attached serial device.

We provide application notes to introduce how to work with 3rd parties' popular virtual com software, please contact us to get more information.

Note:

Virtual COM software (COM port redirector) is a specialized software (often including device driver and user application) that includes the underlying network software necessary to access networked device servers that provide

remote serial devices or modems.

The purpose of the redirector is to make the virtual COM port exhibit behavior that closely resembles that of a "real" COM port, i.e., a COM port driver for local serial port hardware. A virtual COM port itself is a relatively simple software mechanism that can be implemented by driver software similar to that of a conventional COM port driver. The main challenges arise in two other areas: the network connection to the device server and the behavior of the device server. These issues are described in the Technology section below.

Chapter 5. Appendix

5.1 Factory Settings

Factory setting of the gateway COM port under Config Mode and Normal Mode is:

Data bits = 8

Parity = none

Stop bits = 1

Baud = 115200 bps

Flow control = none

5.2 M1000 XP SMS Command for Remote Control

5.2.1 SMS Commands Structure

M1000 XP supports remote configuration and remote gateway status reading via SMS.

An SMS command has the same structure as the CLI command: **Password: command**

- Password: SMS control password is configured at **NMS->SMS Control->Password**, which is an optional parameter.
- Command: please check all the SMS commands in section 5.2.3, usually we will want to get existing settings (use "get" command) or set new parameters (use "set" command) of M1000 XP.
- When there is a password, SMS command has following structure: **Password: command**
- When there is no password, SMS command has following structure: **command**

5.2.2 SMS Control Steps

1. Send the first SMS command to M1000 XP: **Password: command** or **command**;
2. If the first SMS command is used to configure new parameter, remember to send the second SMS commands "save", and third SMS commands "reboot" to save new settings and reboot M1000 XP.

5.2.3 SMS Commands List

Command		Value	
com			
get/set	com	baudrate	1200, 2400, 4800, 9600, 19200, 38400, 57600, 115200
		databits	7,8
		stopbits	1,2
		parity	none, odd, even, mark, space
		flowctrl	true, false
data_packing			
get/set	data_packing	interval	2-1000
		length	1-5000
		delimiter1_enable	true, false
		delimiter1	hex character
		delimiter2_enable	true, false
		delimiter2	hex character
		process	none, strip
pin			
get/set	pin		
gprs			
get/set	gprs	auth_type	none, auto, pap, chap
		apn	string, max length 50
		username	string, max length 32
		password	string, max length 32
		dns_mode	use_peer_dns, manual
		dns1	string, max length 15
		dns2	string, max length 15
connection			
get/set	connection	socket_mode	udp, tcp_client, tcp_server
		address	string, max length 64
		port	1-65535
		connect_mode	always_online, connect_on_demand
		idle_time	10-1200
		retries	1-60
		interval	10-1200
		online_notify_enable	true, false
		notify_phonergroup	1-10
		csd_enable	true, false
		csd_phonergroup	1-10

tcp_advanced					
get/set	tcp_advanced	keepalive_idle		60-7200	
		keepalive_interval		10-180	
		keepalive_retries		3-10	
		max_server_conn		1-3	
		always_accept_new		true, false	
ping					
get/set	ping	address		string, max length 64	
		interval		5-1800	
		retry_interval		5-1800	
		retries		0-10	
ddns					
get/set	ddns	server		none, dyndns, 3322, no-ip	
		hostname		string, max length 64	
		username		string, max length 24	
		password		string, max length 24	
reboot					
get/set	reboot	timing1	enable	true, false	
			hour	0-23	
			minute	0-59	
		timing2	enable	true, false	
			hour	0-23	
			minute	0-59	
		timing3	enable	true, false	
			hour	0-23	
			minute	0-59	
		call_reboot_enable		true, false	
		cr_phonergroup		1-6	
		cr_reply_enable		true, false	
		sms_reboot_enable		true, false	
		sr_phonergroup		1-6	
sr_password		string, max length 20			
sr_reply_enable		true, false			
wakeup					
get/set	wakeup	timing1	enable	true, false	
			hour	0-23	
			minute	0-59	
		timing2	enable	true, false	
			hour	0-23	
			minute	0-59	
		timing3	enable	true, false	
			hour	0-23	

		minute	0-59
		period_wakeup_enable	true, false
		period	3-720 (min)
		call_wakeup_enable	true, false
		cw_phonergroup	1-6
		cw_reply_enable	true, false
		sms_wakeup_enable	true, false
		sw_phonergroup	1-6
		sw_password	string, max length 20
		sw_reply_enable	true, false
		data_wakeup_enable	true, false
		online_output_data	string, max length 48
nms			
get/set	nms	device_name	string, max length 20
		password	string, max length 16
		sms_ctrl_password	string, max length 20
		sms_ctrl_phonergroup	1-6
		tcp_nms_enable	true, false
		nms_port	1-65535
sntp			
get/set	sntp	enable	true, false
		timezone	-12, -11, -10, -09, -08, -07, -06, -05, -04, -03, -02, -01, 00, +01, +02, +03, +04, +05, +06, +07, +08, +09, +10, +11, +12
		maxretry	1-10
		specify_sntp_server	true, false
		server_addr	string, max length 64
		port	1-65535
		phonergroup	
get/set	phonergroup	phonenum1	string, max length 120 (use ";" to separate each number)
		phonenum2	string, max length 120 (use ";" to separate each number)
		phonenum3	string, max length 120 (use ";" to separate each number)
		phonenum4	string, max length 120 (use ";" to separate each number)
		phonenum5	string, max length 120 (use ";" to separate each number)
		phonenum6	string, max length 120 (use ";" to separate each number)

modbus			
get/set	modbus	enable	true, false
debug			
get/set	debug	enable	true, false

5.2.4 SMS Control Examples

Assume that there is no SMS control password configured at Basic->SMS Control->Password. Here is the SMS control examples:

1. Get COM's baudrate :
get com baudrate
2. Set COM's baudrate as 19200:
set com baudrate 19200
save
reboot
3. Add number +8612345678901 to phonegroup1:
set phonegroup phonenum1 +8612345678901
save
reboot
4. Add number +8612345678901 and +8610987654321 to phonegroup2:
set phonegroup phonenum2 +8612345678901;+8610987654321
save
reboot
5. Enable Modbus gateway:
set Modbus enable true
save
reboot

Assume that there is SMS control password "1234" configured at Basic->SMS Control->Password. Here is the SMS control examples:

1. Get COM's baudrate :
1234:get com baudrate
2. Set COM's baudrate as 19200:
1234:set com baudrate 19200
1234:save
1234:reboot
3. Add number +8612345678901 to phonegroup1:
1234:set phonegroup phonenum1 +8612345678901
1234:save
1234:reboot

5.3 Troubleshooting

This section of the document describes possible problems encountered when using the Robustel M1000 XP and their solutions.

5.3.1 The gateway's LED does not light:

- Check if gateway has connected to a 9 to 18 VDC power supply properly.
- Check if the power connector is properly inserted.

5.3.2 No connection with gateway through serial link

- Check if the serial cable has been connected properly.
- Check if the serial cable has been made by following pin assignment given in table **PIN assignment** for RS232 and RS485.
- Check if your program has proper setting. Factory setting of the gateway under Normal Mode is listed at [5.1](#).
- Check if there is another program interfering with the communication program, such as conflict on communication port access.

5.3.3 GSM/GPRS/UMTS connection cannot be established

- Check if the APN, User Name and Password have been input correctly.
- Check if the SIM card balance is enough or not.

5.4 Terms and Abbreviations

Abbreviations	Description
AC	Alternating Current
APN	Access Point Name of GPRS/UMTS Service Provider Network
CE	European Conformity
CHAP	Challenge Handshake Authentication Protocol
CSD	Circuit Switched Data
CTS	Clear to Send
dB	Decibel
dBi	Decibel Relative to an Isotropic radiator
DC	Direct Current

DCD	Data Carrier Detect
DCE	Data Communication Equipment (typically modems)
DCS 1800	Digital Cellular System, also referred to as PCN
DDNS	Dynamic Domain Name Server
DNS	Domain Name Server
DSR	Data Set Ready
DTE	Data Terminal Equipment
DTMF	Dual Tone Multi-frequency
DTR	Data Terminal Ready
EMC	Electromagnetic Compatibility
EMI	Electromagnetic Interference
ESD	Electrostatic Discharges
ETSI	European Telecommunications Standards Institute
GND	Ground
GPRS	General Package Radio Service
GSM	Global Standard for Mobile Communications
IMEI	International Mobile Equipment Identification
kbps	kbits per second
LED	Light Emitting Diode
MAX	Maximum
Min	Minimum
MO	Mobile Originated
MS	Mobile Station
MT	Mobile Terminated
PAP	Password Authentication Protocol
PC	Personal Computer
PCN	Personal Communications Network, also referred to as DCS 1800
PCS	Personal Communication System, also referred to as GSM 1900
PDU	Protocol Data Unit
PPP	Point-to-point Protocol
PIN	Personal Identity Number
PSU	Power Supply Unit
PUK	Personal Unblocking Key
R&TTE	Radio and Telecommunication Terminal Equipment
RF	Radio Frequency
RTC	Real Time Clock
RTS	Request to Send
Rx	Receive Direction
SIM	Subscriber Identification Module
SMA	Subminiature Version A RF Connector
SMS	Short Message Service
TCP/IP	Transmission Control Protocol / Internet Protocol

TE	Terminal Equipment, also referred to as DTE
Tx	Transmit Direction
UART	Universal Asynchronous Receiver-transmitter
UDP	User Datagram Protocol
USSD	Unstructured Supplementary Service Data
VSWR	Voltage Stationary Wave Ratio