

Robustel GoRugged R3000

Dual SIM Industrial Cellular VPN Router

For GPRS/EDGE/UMTS/HSPA+/LTE Networks

User Guide

Document Name: **User Guide**
Firmware: **1.2.6**
Date: **2015-05-28**
Status: **Confidential**
Doc ID: **RT_UG_R3000_v.2.1.0**



About This Document

This document describes hardware and software of Robustel R3000, Dual SIM Industrial 2G/3G/4G Router.

Copyright© Guangzhou Robustel Technologies Co., Limited

All Rights Reserved.

Trademarks and Permissions

Robustel are trademark of Guangzhou Robustel Technologies Co., Limited.

All other trademarks and trade names mentioned in this document are the property of their respective holders.

Disclaimer

No part of this document may be reproduced in any form without the written permission of the copyright owner. The contents of this document are subject to revision without notice due to continued progress in methodology, design and manufacturing. Robustel shall have no liability for any error or damage of any kind resulting from the use of this document.

Technical Support Contact Information

Tel: +86-20-23354618

Fax: +86-20-82321505

E-mail: support@robustel.com

Web: www.robustel.com

Important Notice

Due to the nature of wireless communications, transmission and reception of data can never be guaranteed. Data may be delayed, corrupted (i.e., have errors) or be totally lost. Although significant delays or losses of data are rare when wireless devices such as the router is used in a normal manner with a well-constructed network, the router should not be used in situations where failure to transmit or receive data could result in damage of any kind to the user or any other party, including but not limited to personal injury, death, or loss of property. Robustel accepts no responsibility for damages of any kind resulting from delays or errors in data transmitted or received using the router, or for failure of the router to transmit or receive such data.

Safety Precautions**General**

- The router generates radio frequency (RF) power. When using the router, care must be taken on safety issues related to RF interference as well as regulations of RF equipment.
- Do not use your router in aircraft, hospitals, petrol stations or in places where using cellular products is prohibited.
- Be sure that the router will not be interfering with nearby equipment. For example: pacemakers or medical equipment. The antenna of the router should be away from computers, office equipment, home appliance, etc.
- An external antenna must be connected to the router for proper operation. Only uses approved antenna with the router. Please contact authorized distributor on finding an approved antenna.
- Always keep the antenna with minimum safety distance of 20 cm or more from human body. Do not put the antenna inside metallic box, containers, etc.
- RF exposure statements
 1. For mobile devices without co-location (the transmitting antenna is installed or located more than 20cm away from the body of user and nearby person)
- FCC RF Radiation Exposure Statement
 1. This Transmitter must not be co-located or operating in conjunction with any other antenna or transmitter.
 2. This equipment complies with FCC RF radiation exposure limits set forth for an uncontrolled environment. This equipment should be installed and operated with a minimum distance of 20 centimeters between the radiator and human body.

Note: *Some airlines may permit the use of cellular phones while the aircraft is on the ground and the door is open. Router may be used at this time.*

Using the router in vehicle

- Check for any regulation or law authorizing the use of cellular devices in vehicle in your country before installing the router.
- The driver or operator of any vehicle should not operate the router while driving.
- Install the router by qualified personnel. Consult your vehicle distributor for any possible interference of electronic parts by the router.
- The router should be connected to the vehicle's supply system by using a fuse-protected terminal in the vehicle's fuse box.
- Be careful when the router is powered by the vehicle's main battery. The battery may be drained after extended period.

Protecting your router

- To ensure error-free usage, please install and operate your router with care. Do remember the following:

- Do not expose the router to extreme conditions such as high humidity / rain, high temperature, direct sunlight, caustic / harsh chemicals, dust, or water.
- Do not try to disassemble or modify the router. There is no user serviceable part inside and the warranty would be void.
- Do not drop, hit or shake the router. Do not use the router under extreme vibrating conditions.
- Do not pull the antenna or power supply cable. Attach/detach by holding the connector.
- Connect the router only according to the instruction manual. Failure to do it will void the warranty.
- In case of problem, please contact authorized distributor.

Regulatory and Type Approval Information

Table 1: Directives



2011/65/EC	Directive 2011/65/EU of the European Parliament and of the Council of 8 June 2011 on the restriction of the use of certain hazardous substances in electrical and electronic equipment (RoHS)	
2012/19/EU	Directive 2012/19/EU the European Parliament and of the Council of 4 July 2012 on waste electrical and electronic equipment (WEEE)	

Table 2: Standards of the Ministry of Information Industry of the People’s Republic of China

SJ/T 11363-2006	“Requirements for Concentration Limits for Certain Hazardous Substances in Electronic Information Products” (2006-06).	
SJ/T 11364-2006	<p>“Marking for Control of Pollution Caused by Electronic Information Products” (2006-06).</p> <p>According to the “Chinese Administration on the Control of Pollution caused by Electronic Information Products” (ACPEIP) the EPUP, i.e., Environmental Protection Use Period, of this product is 20 years as per the symbol shown here, unless otherwise marked. The EPUP is valid only as long as the product is operated within the operating limits described in the Hardware Interface Description.</p> <p>Please see Table 3 for an overview of toxic or hazardous substances or elements that might be contained in product parts in concentrations above the limits defined by SJ/T 11363-2006.</p>	

Table 3: Toxic or hazardous substances or elements with defined concentration limits

Name of the part	Hazardous substances					
	(Pb)	(Hg)	(Cd)	(Cr (VI))	(PBB)	(PBDE)
Metal Parts	o	o	o	o	o	o
Circuit Modules	x	o	o	o	o	o
Cables and Cable Assemblies	o	o	o	o	o	o
Plastic and Polymeric parts	o	o	o	o	o	o
<p>o: Indicates that this toxic or hazardous substance contained in all of the homogeneous materials for this part is below the limit requirement in SJ/T11363-2006.</p> <p>x: Indicates that this toxic or hazardous substance contained in at least one of the homogeneous materials for this part <i>might exceed</i> the limit requirement in SJ/T11363-2006.</p>						

Revision History

Updates between document versions are cumulative. Therefore, the latest document version contains all updates made to previous versions.

Release Date	Firmware Version	Doc Version	Details
2013-01-24	1.00.00	V1.0.0	First Release
2014-01-17	1.01.00	V2.0.0	Second Release
2014-03-29	1.01.01	V2.0.1	Update WLAN, GPS antenna information for section 2.8 and DHCP, Device List information for section 3.5.
2014-04-28	1.01.01	V2.0.2	Delete the introduction of R3000-2E since it reached EOL
2014-08-01	1.01.18	V2.0.3	Update feature: Pppoe, SSH2, Do control via Web, QoS Port Based Control and RobustVPN; delete IP-Passthrough.
2014-10-23	1.01.18	V2.0.4	Update label of R3000.
2014-12-24	1.02.00	V2.0.5	Delete HSUPA. Update Section: Regulatory and Type Approvals, Install SIM Card and Micro SD Card, Power Supply Update Feature: WiFi-Basic, GPS-GPS Status, NAT/DMZ-Virtual IP Mapping, Firewall-Basic, Firewall-Filtering, QoS, OpenVPN-Encryption, L2TP Server, Portal, RobustVPN, Tools-Sniffer, Tools-Test, Clock-GPS Time Sync
2015-05-13	1.2.0	V2.0.6	Modify Section: Firmware Version, Mount the Route, file format, Sentence Revision, Approval & Certification, Regulatory and Type Approval Information
2015-05-28	1.2.8	V2.1.0	Increase section: Download MIB Moudles File, GpsGate portal Modify section: SDK Management, CLI command

Contents

Chapter 1	Product Concept.....	8
1.1	Overview	8
1.2	Packing List	9
1.3	Specifications	10
1.4	Selection and Ordering Data	13
Chapter 2	Installation.....	14
2.1	LED Indicators.....	14
2.2	PIN Assignment	15
2.3	USB Interface.....	15
2.4	Reset Button.....	16
2.5	Ethernet Ports	16
2.6	Mount the Router	17
2.7	Install SIM Card and Micro SD Card.....	18
2.8	Connect the External Antenna	19
2.9	Ground the Router	19
2.10	Power Supply.....	20
Chapter 3	Configuration Settings over Web Browser	21
3.1	Configuring PC in Windows 7	21
3.2	Factory Default Settings	23
3.3	Control Panel.....	24
3.4	Status -> System	25
3.5	Status -> Network.....	28
3.6	Status -> Route	29
3.7	Status -> VPN.....	30
3.8	Status -> Services	31
3.9	Status -> Event/Log	32
3.10	Configuration -> Link Management.....	33
3.11	Configuration -> Cellular WAN	34
3.12	Configuration -> Ethernet.....	40
3.13	Configuration -> WiFi	44
3.14	Configuration -> Serial.....	48
3.15	Configuration -> DI/DO.....	56
3.16	Configuration -> USB	59
3.17	Configuration -> GPS	59
3.18	Configuration -> NAT/DMZ	62
3.19	Configuration -> Firewall	64
3.20	Configuration -> QoS.....	66
3.21	Configuration -> IP Routing.....	70
3.22	Configuration -> DynDNS	73
3.23	Configuration -> IPsec.....	74
3.24	Configuration -> Open VPN	79
3.25	Configuration -> GRE	84

3.26	Configuration -> L2TP	85
3.27	Configuration -> PPTP.....	89
3.28	Configuration -> SNMP	92
3.29	Configuration -> VRRP	94
3.30	Configuration -> AT over IP.....	95
3.31	Configuration -> Phone Book	96
3.32	Configuration -> SMS.....	97
3.33	Configuration -> Reboot.....	98
3.34	Configuration -> Portal	99
3.35	Configuration -> Syslog.....	101
3.36	Configuration -> Event.....	102
3.37	Configuration -> USR LED	102
3.38	Configuration -> RobustVPN.....	103
3.39	Administration -> Profile	104
3.40	Administration -> Tools	105
3.41	Administration -> Clock	109
3.42	Administration -> Web Server	110
3.43	Administration -> User Management.....	111
3.44	Administration -> SDK Management.....	112
3.45	Administration -> Update Firmware.....	113
Chapter 4	Configuration Examples	114
4.1	Interface	114
4.1.1	Console Port	114
4.1.2	Digital Input	115
4.1.3	Digital Output	115
4.1.4	RS232	116
4.1.5	RS485.....	116
4.2	Cellular	117
4.2.1	Cellular Dial-Up.....	117
4.2.2	SMS Remote Status Reading.....	119
4.3	Network.....	121
4.3.1	NAT.....	121
4.3.2	L2TP	122
4.3.3	PPTP.....	123
4.3.4	IPSEC VPN	125
4.3.5	OPENVPN	128
Chapter 5	Introductions for CLI.....	131
5.1	What's CLI and Hierarchy Level Mode.....	131
5.2	How to Configure the CLI	133
5.3	Commands Reference	137
Glossary.....		138

Chapter 1 Product Concept

1.1 Overview

Robustel GoRugged R3000 is a rugged cellular router offering state-of-the-art mobile connectivity for machine to machine (M2M) applications.

- Dual SIM redundancy for continuous cellular connections, supports 2G/3G/4G.
- WAN link management: cellular WAN/Ethernet WAN/WLAN WAN backup.
- VPN tunnel: IPSec/OpenVPN/PPTP/L2TP/GRE.
- Supports Modbus gateway (Modbus RTU/ASCII to Modbus TCP).
- Supports GPS&GLONASS (optional), provides real time location and tracking.
- Supports 802.11 b/g/n Wi-Fi (optional), AP and client mode.
- Supports SDK, provides user programmatic interface.
- Supports 802.1Q VLAN Trunk.
- Supports PPPoE Bridge(IP Passthrough).
- Auto reboot via SMS/Caller ID/Timing.
- Supports RobustLink(Centralized M2M management platform, to remote monitor, configure and update firmware).
- Supports RobustVPN (Cloud VPN Portal, to provide easy and secure remote access for PLCs and machines).
- Flexible Management methods: Web/CLI/SNMP/RobustLink.
- Firmware upgrade via Web/CLI/USB/SMS/RobustLink.
- Various interfaces: RS232/RS485/Console/DI/DO/USB/Ethernet.
- Wide range input voltages from 9 to 60 VDC and extreme operating temperature.
- The metal enclosure can be mounted on a DIN-rail or on the wall, also with extra ground screw.

1.2 Packing List

Check your package to make sure it contains the following items:

- Robustel GoRugged R3000 router x 1



- 3-pin pluggable terminal block with lock for power connector x 1



- 7-pin pluggable terminal block with lock for serial port, I/O and console port x 1



- CD with user guide x 1

Note: Please notify your sales representative if any of the above items are missing or damaged.

Optional accessories (can be purchased separately):

- SMA antenna (Stubby antenna or Magnet antenna optional) x 1

Stubby antenna



Magnet antenna



- Ethernet cable x 1



- Wall Mounting Kit



- 35mm Din-Rail mounting kit



- AC/DC Power Supply Adapter (12VDC, 1.5A) x 1 (EU, US, UK, AU plug optional)



1.3 Specifications

Cellular Interface

- Standards: GSM/GPRS/EDGE/UMTS/HSPA/EVDO/FDD LTE
- GPRS/EDGE: 850/900/1800/1900 MHz
- HSPA+: 850/900/1900/2100 MHz, DL/UL 21/5.76 Mbps, fallback to 2G
- FDD LTE: 800/900/1800/2100/2600 MHz, DL/UL 100/50 Mbps, fallback to 3G/2G
- EVDO: 450 or 800/1900 MHz, Rev A/B
- SIM: 2 x (3V & 1.8V)

- Antenna Interface: SMA Female

Ethernet Interface

- Number of Ports: 2 x 10/100 Mbps, 2 LANs or 1 LAN 1 WAN
- Magnet Isolation Protection: 1.5KV

WLAN Interface (Optional)

- Standards: 802.11b/g/n up to 65 Mbps, AP and Client mode
- Frequency Band: 2.400 - 2.500 GHz (2.4 GHz ISM band)
- Security: Open ,WPA, WPA2
- Encryption: AES, TKIP
- Antenna Interface: RP-SMA Female
- Transmission Power: 802.11b: 17dBm, 802.11g/n: 15dBm
- Reception Sensibility: 1M: -97dBm, 2M: -93dBm, 6M: -91dBm, 11M: -89dBm, 54M: -75dBm, 65M: -72dBm

Digital Input

- Type: 2 x DI, Dry Contact
- Dry Contact: On: open, Off: short to GND
- Isolation: 3K VDC or 2K Vrms
- Absolute Maximum VDC: 5V
- Digital Filtering Time Interval: Software selectable
- Interface: 3.5mm terminal block with lock

Digital Output

- Type: 2 x DO, Sink
- Isolation: 3K VDC or 2K Vrms
- Absolute Maximum VDC: 30V
- Absolute Maximum ADC: 300mA
- Interface: 3.5mm terminal block with lock

Serial Interface

- Number of Ports: 1 x RS-232, 1 x RS-485 or 2 x RS232 or 2 x RS485
- ESD Protection: $\pm 15\text{KV}$
- Parameters: 8E1, 8O1, 8N1, 8N2, 7E2, 7O2, 7N2, 7E1
- Baud Rate: 300bps to 230400bps
- RS-232: TxD, RxD, RTS, CTS, GND
- RS-485: Data+ (A), Data- (B)
- Interface: 3.5mm terminal block with lock

GPS & GLONASS Interface (Optional)

- Antenna Interface: SMA Female, 50 ohms impedance
- Tracking Sensitivity: GPS: better than -148 dBm
GLONASS: better than -140 dBm
- Horizontal position accuracy: GPS: 2.5 m
GLONASS: 4.0 m
- Time-To-First-Fix: GPS: 26 s
GLONASS: 30 s
- Protocol: NMEA-0183 V2.3

System

- LED Indicators: RUN, PPP/WLAN, USR, RSSI, NET, SIM
- Built-in RTC, Watchdog, Timer
- Expansion: 1 x USB 2.0 host up to 480 Mbps
- Storage: 1 x MicroSD

Software

- Network protocols: PPP, PPPoE, TCP, UDP, DHCP, ICMP, NAT, DMZ, RIP v1/v2, OSPF, DDNS, VRRP, HTTP, HTTPS, DNS, ARP, QoS, SNTP, Telnet, VLAN, SSH2, etc
- VPN tunnel: IPSec/OpenVPN/PPTP/L2TP/GRE

- Firewall: SPI, anti-DoS, Filter, Access Control
- Management: Web, CLI, SNMP v1/v2/v3, SMS, RobustLink
- Serial Port: TCP client/server, UDP, Modbus RTU/ASCII to Modbus TCP, Virtual COM (COM port redirector)
- RobustLink: Centralized M2M management platform
- RobustVPN: Cloud VPN Portal

Power Supply and Consumption

- Power Supply Interface: 5mm terminal block with lock
- Input Voltage: 9 to 60 VDC
- Power Consumption: Idle: 100 mA @ 12 V

Data Link: 400 mA (peak) @ 12 V

Physical Characteristics

- Housing & Weight: Metal, 500g
- Dimension: (L x W x H): 125 x 108 x 45 mm
- Installation: 35mm Din-Rail or wall mounting or desktop

Regulatory and Type Approvals

- Approval & Certification: CE, R&TTE,FCC, PTCRB, GCF, AT&T, IC,
Rogers, RCM, CB, E-Mark, NBTC, RoHS, WEEE
- EMI : EN 55022 (2006/A1: 2007) Class B
- EMC: EN 61000-4-2 (ESD) Level 4, EN 61000-4-3 (RS) Level 4
EN 61000-4-4 (EFT) Level 4, EN 61000-4-5 (Surge) Level 3
EN 61000-4-6 (CS) Level 4, EN 61000-4-8 Level 4

Environmental Limits

Model No.	Description	Operating Environment
R3000-2G	GPRS Router	-40 to 85°C/5 to 95% RH
R3000-3P	HSPA+ Router	-40 to 85°C/5 to 95% RH
R3000-3E	EVDO Rev A/B Router	-20 to 60°C/5 to 95% RH
R3000-4L	FDD LTE Router	-40 to 85°C/5 to 95% RH

1.4 Selection and Ordering Data

Please refer to corresponding R3000 datasheet.

Chapter 2 Installation

2.1 LED Indicators

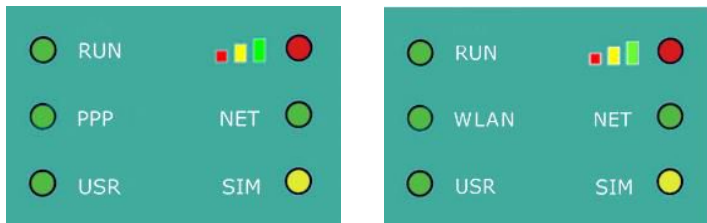

Name	Color	Status	Function
RUN	Green	Blinking	Router is ready.
		On	Router is starting.
		Off	Router is power off.
WLAN/PPP	Green	Blinking	WLAN Indicator: Data is being transmitted. PPP Indicator: Null
		On	WLAN Indicator: Wi-Fi AP/Client is enabled. PPP Indicator: PPP connection is up.
		Off	WLAN Indicator: Wi-Fi AP/Client is disabled. PPP Indicator: PPP connection is down.
USR	Green	On/Blinking	VPN tunnel/PPPoE/DynDNS/GPS is up.
		Off	VPN tunnel/PPPoE/DynDNS/GPS is down.
	Green	On	Signal level: 21-31 (Perfect signal level).
	Yellow	On	Signal level: 11-20 (Average signal level).
	Red	On	Signal level: 1-10 (Exceptional signal level).
NET	Green	Blinking	4G is connected but PPP connection is failed.
		On	4G is connected and PPP connection is established.
	Yellow	Blinking	3G is connected but PPP connection is failed.
		On	3G is connected and PPP connection is established.
	Red	Blinking	2G is connected but PPP connection is failed.
		On	2G is connected and PPP connection is established.
/	Off	Cannot register to any network.	
SIM	Green	Blinking	Only SIM 1 is detected, but PIN code is incorrect.
		On	Working with SIM 1 normally.
	Yellow	Blinking	Only SIM 2 is detected, but PIN code is incorrect.
		On	Working with SIM 2 normally.
	Green&Yellow	Blinking between two colors	Two SIMs are detected, but both of their PIN codes are incorrect.
	/	Off	No SIM inside.

Note: User can select display status of USR LED. For details please refer to section 23.37.

2.2 PIN Assignment

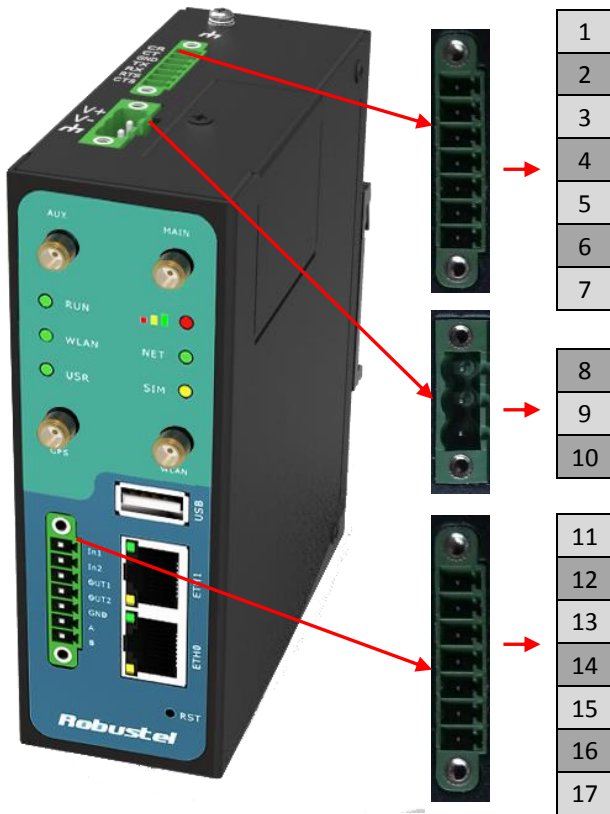

PIN	Debug	RS232	Direction
1	RXD		Device → R3000
2	TXD		R3000 → Device
3	GND	GND	
4		TXD	R3000 → Device
5		RXD	Device → R3000
6		RTS	R3000 → Device
7		CTS	Device → R3000

PIN	Power	Digital I/O	RS485
8	Positive		
9	Negative		
10	GND		
11		Input 1	
12		Input 2	
13		Output 1	
14		Output 2	
15		GND	
16			Data+(A)
17			Data-(B)

2.3 USB Interface

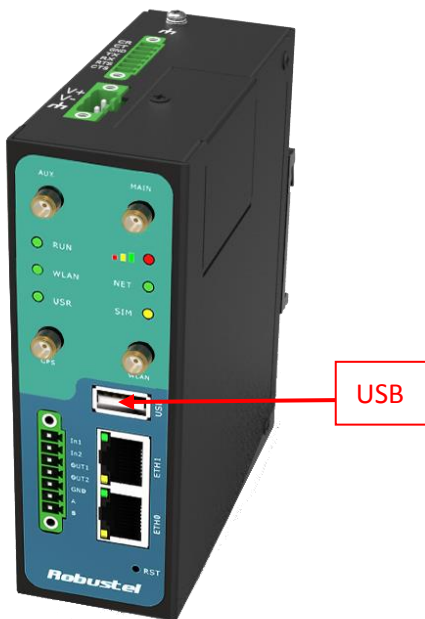

USB interface is used for batch firmware upgrade, cannot used to send or receive data from slave devices which with USB interface.

Users can insert a USB storage device, such as U disk or hard disk, into the router's USB interface, if there is configuration file or firmware of R3000 inside the USB storage devices, R3000 will automatically update the configuration file or firmware. Details please refer to section 23.16.

2.4 Reset Button



Function	Operation
Reboot	Push the button for 5 seconds under working status.
Restore to factory default setting	Push the button for 60 seconds once you power on the router until all the three LEDs at the left side (RUN, PPP, USR) blink at the same time for 5 times.

2.5 Ethernet Ports



Each Ethernet port has two LED indicators (please check the following picture). The yellow one is **Speed indicator** and the green one is **Link indicator**. There are three status of each indicator. For details please refer to the form below.

Indicator	Status	Description
Speed Indicator	Off	10 Mbps mode.
	On	100 Mbps mode.
Link Indicator	Off	Connection is down.
	On	Connection is up.
	Blink	Data is being transmitted

2.6 Mount the Router

- **Two ways of mounting the router**

1. Use 3 pcs of M3 screw to mount the router on the Wall mounting Kit.
And then use 2 pcs of M3 screw to mount the Wall mounting Kit on the wall.



2. Mount the router on a DIN rail with 3 pcs of M3 screws, and then hang the DIN-Rail on the holder.
You need to choose a standard holder.

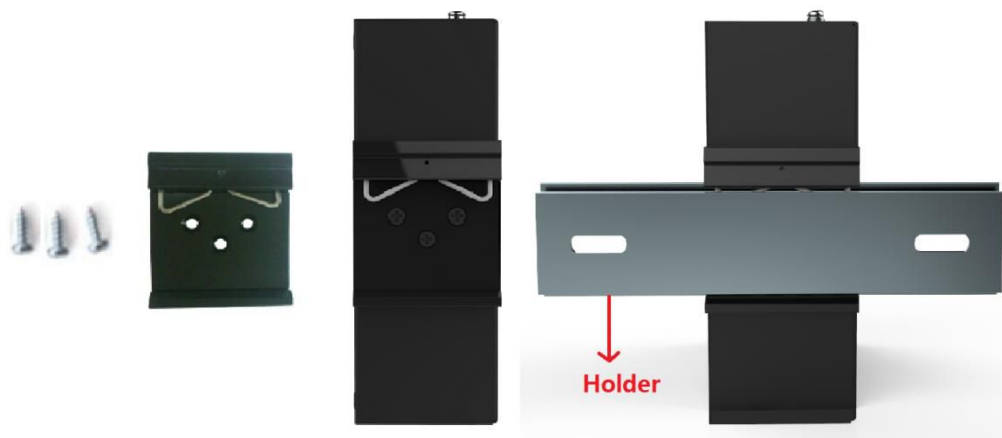

2.7 Install SIM Card and Micro SD Card



- **Inserting SIM Card or Micro SD Card**

1. Make sure power supply is disconnected.
2. Use a screwdriver to unscrew the screw on the cover, and then remove the cover, you could find the SIM Card slots and the Micro SD slot.
3. Insert the SIM card or Micro SD card, and you need press the card with your fingers until you hear “a cracking sound”. Then use a screwdriver to screw the cover.

- **Removing SIM Card or Micro SD Card**

1. Make sure router is power off.
2. Press the card until you hear “a cracking sound”, when the card will pop up to be pulled out.

Note:

1. Please use the specific M2M SIM card when the device works in extreme temperature(temperature exceeding 0-40 °C), because the long-time working of regular SIM card in harsh environment(temperature exceeding 0-40 °C)may increase the possibility of SIM card failure.
2. Don't forget screw the cover for again-theft.
3. Don't touch the metal surface of the SIM card in case information in the card is lost or destroyed.
4. Don't bend or scratch your SIM card. Keep the card away from electricity and magnetism.
5. Make sure router is power off before inserting or removing your SIM card or Micro SD card.

2.8 Connect the External Antenna

Connect router with an external antenna connector. Make sure the antenna is within correct frequency range and is screwed tightly.

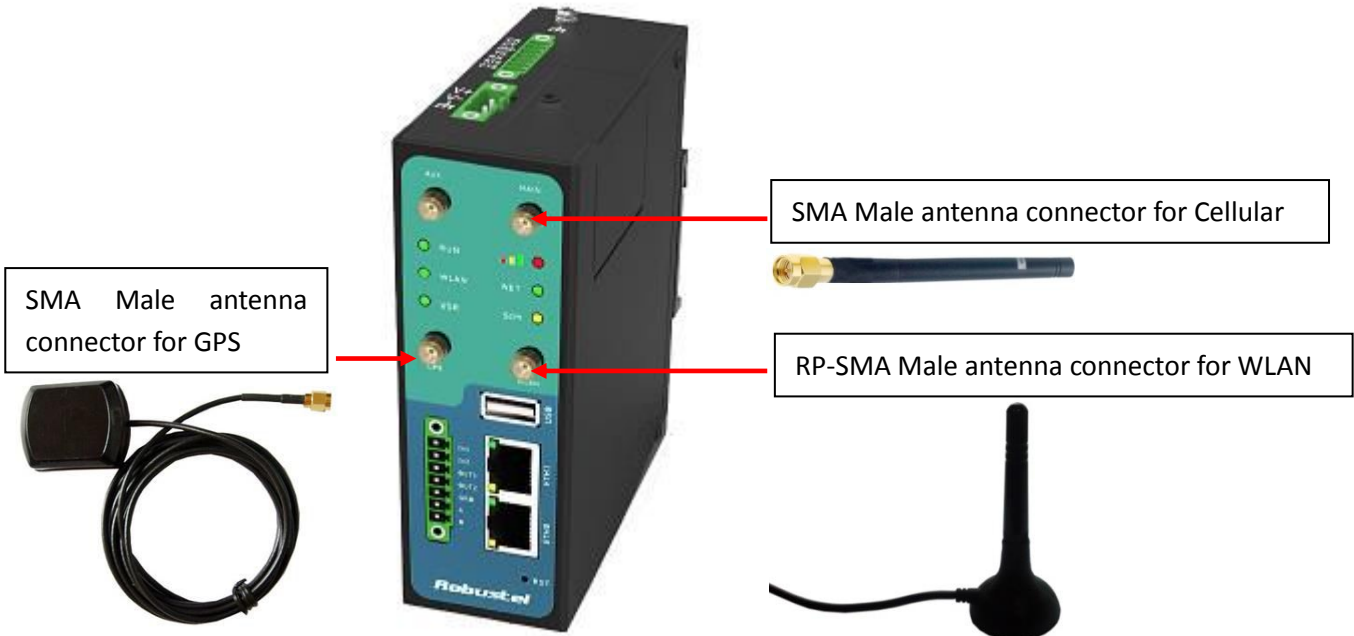

2.9 Ground the Router

Grounding and wire router helps limit the effects of noise due to electromagnetic interference (EMI). Run the ground connection from the ground by screwing to the grounding surface before connecting devices.

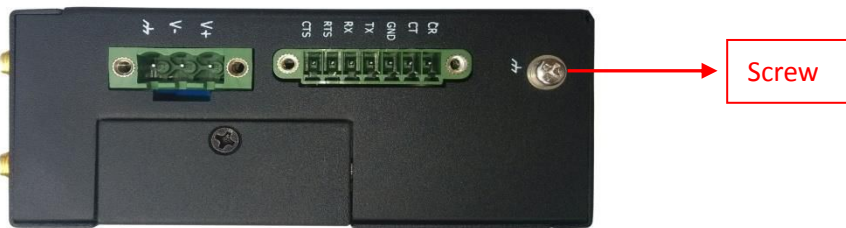

Note: This product is intended to be mounted to a well-grounded mounting surface, such as a metal panel.

2.10 Power Supply

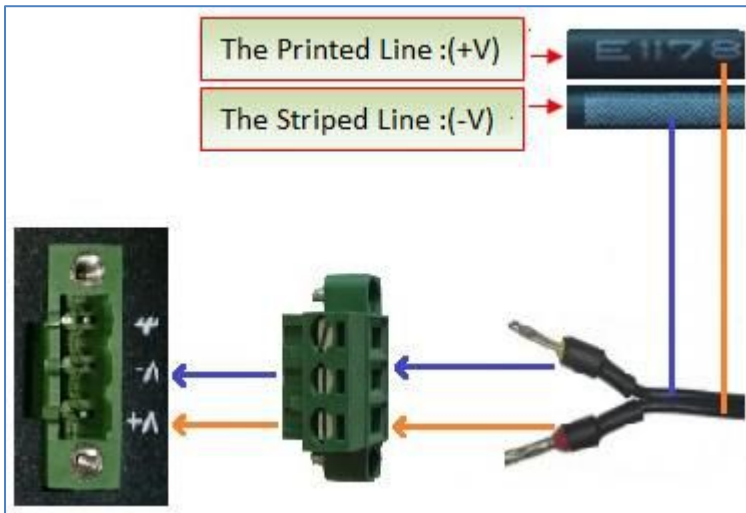

The power supply range is 9 to 60 VDC.

Note: Please take care about the polarity, and do not make reverse connection. There are two lines connecting to the power supply adapter, as it illustrates on the power supply adapter label, the line printed with letters needs to be connected with the positive polarity, and the striped line needs to be connected with the negative polarity.

Chapter 3 Configuration Settings over Web Browser

The router can be configured through your web browser that include IE 8.0 or above, Chrome and Firefox. A web browser is included as a standard application in the following operating systems: Linux, Mac OS, Windows 98/NT/2000/XP/Me/Vista/7/8, etc. It provides an easy and user-friendly interface for configuration.

There are various ways to connect the router, either through an external repeater/hub or connect directly to your PC. However, make sure that your PC has an Ethernet interface properly installed prior to connecting the router.

You must configure your PC to obtain an IP address through a DHCP server or a fixed IP address that must be in the same subnet as the router. If you encounter any problems accessing the router web interface it is advisable to uninstall your firewall program on your PC, as this tends to cause problems accessing the IP address of the router.

3.1 Configuring PC in Windows 7

The configuration for windows system is similar.

1. Go to *Start / Control Panel* (in Classic View). In the Control Panel, double-click *Network Connections*.
2. Double-click *Local Area Connection*.

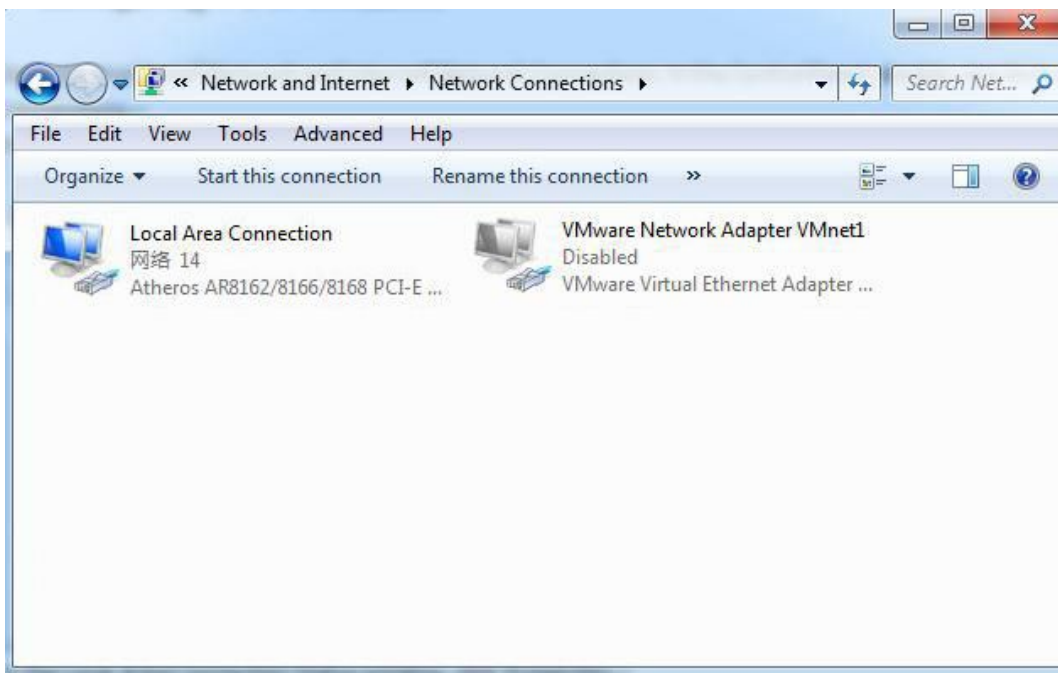

3. In the *Local Area Connection Status* window, click *Properties*.

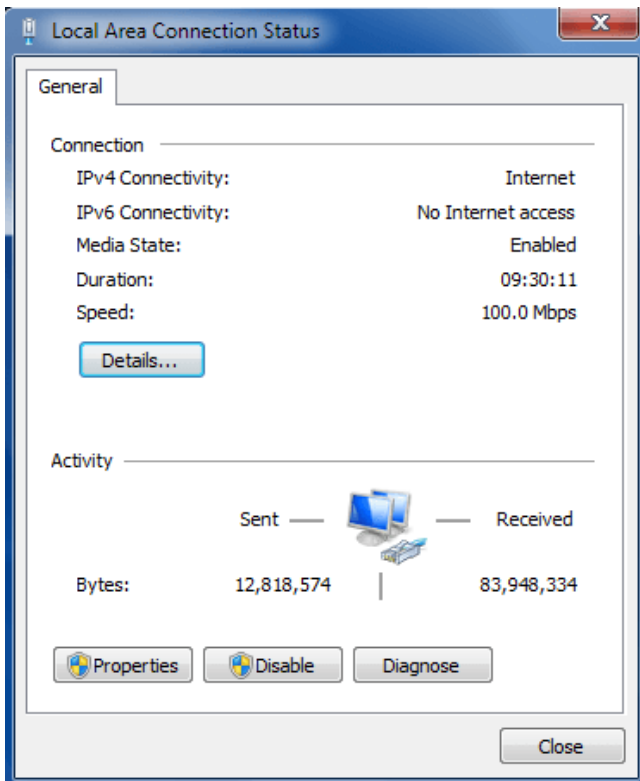

4. Select *Internet Protocol (TCP/IP)* and click *Properties*.

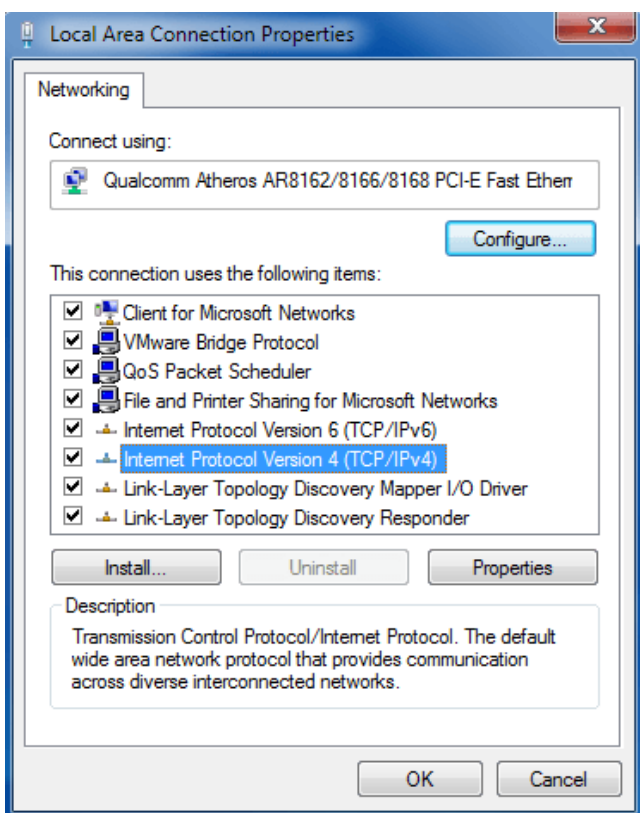

5. Select *Obtain an IP address automatically* and *Obtain DNS server address automatically* radio buttons.

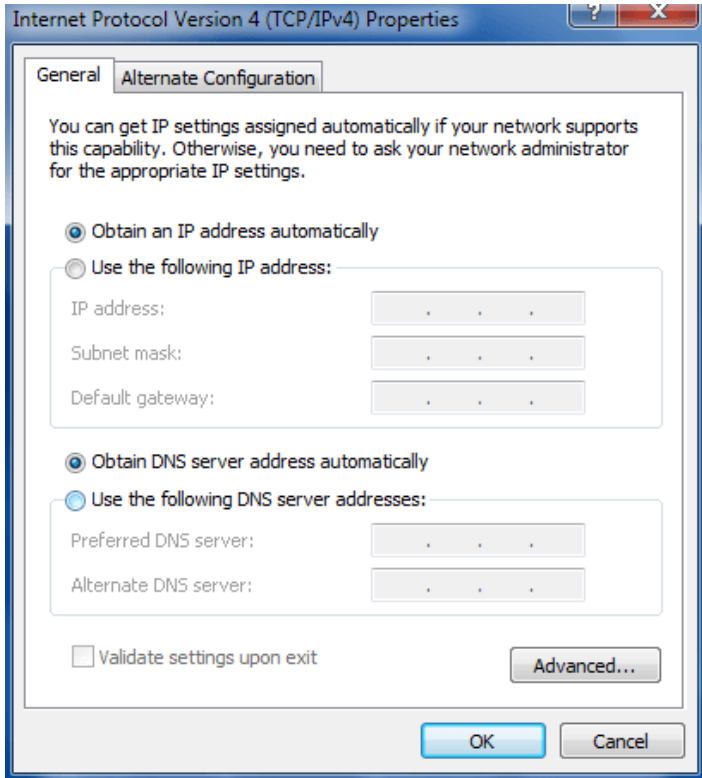

6. Click *OK* to finish the configuration.

3.2 Factory Default Settings

Before configuring your router, you need to know the following default settings.

User authentication required. Login please.

Username:

Password:

Language: ▼

Please enter your login username and password.

Item	Description
Username	admin
Password	admin
Eth0	192.168.0.1/255.255.255.0, LAN mode
Eth1	192.168.0.1/255.255.255.0, LAN mode
DHCP Server	Enabled.



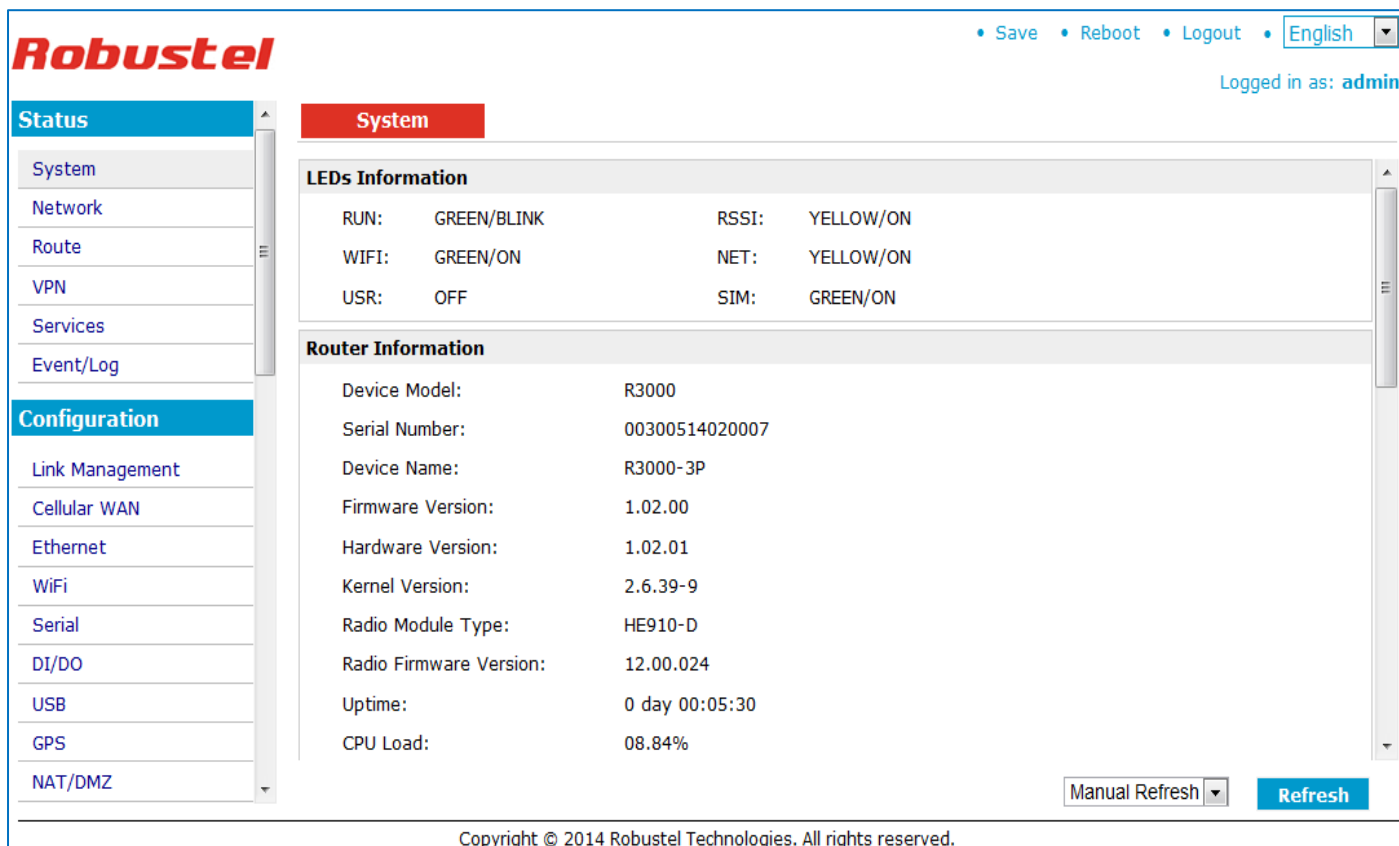

3.3 Control Panel

This section allows users to save configuration, reboot router, logout and select language.



Control Panel		
Item	Description	Button
Save	Click to save the current configuration into router’s flash.	• Save
Reboot	After save the current configuration, router needs to be rebooted to make the modification taking effect.	• Reboot
Logout	Click to return to the login page.	• Logout
Language	Select from Chinese, English, German, French and Spanish.	• English ▼
Refresh	Click to refresh the status.	Refresh
Apply	Click to apply the modification on every configuration page.	Apply
Cancel	Click to cancel the modification on every configuration page.	Cancel

Note: The steps of how to modify configuration are as bellow:

1. Modify in one page;
2. Click  under this page;
3. Modify in another page;
4. Click  under this page;
5. Complete all modification;
6. Click  ;
7. Click  .

3.4 Status -> System

This section displays the router’s system status, which shows you a number of helpful information such as the LEDs information, Router information, Current WAN Link and Cellular Information.

LEDs Information

For the detail description, please refer to 2.1LED Indicators.

System

LEDs Information

RUN:	GREEN/BLINK	RSSI:	RED/ON
PPP:	GREEN/ON	NET:	YELLOW/ON
USR:	GREEN/ON	SIM:	GREEN/ON

Router Information

Device Model:	R3000
Serial Number:	00300514020007
Device Name:	R3000-3P
Firmware Version:	1.2.0
Hardware Version:	1.02.01
Kernel Version:	2.6.39-9
Radio Module Type:	HE910-D
Radio Firmware Version:	12.00.024
Uptime:	0 day 00:05:30
CPU Load:	08.84%
RAM Total/Free:	123.02MB/59.15MB(48.08%)
System Time:	2014-12-25 14:59:32

Router Information	
Item	Description
Device Model	Show the model name of this device
Serial Number	Show the serial number of this device
Device Name	Show the device name to distinguish different devices you have installed.
Firmware Version	Show the current firmware version
Hardware Version	Show the current hardware version
Kernel Version	Show the current kernel version
Radio Module Type	Show the current radio module type
Radio Firmware Version	Show the current radio firmware version
Uptime	Show how long the router have been working since power on
CPU Load	Show the current CPU load
RAM Total/Free	Show the total capacity /Free capacity of RAM
System Time	Show the current system time

Current WAN Link

Current WAN Link:	Cellular
IP Address:	10.188.180.135
Gateway:	192.168.254.254
NetMask:	255.255.255.255
DNS Server:	210.21.4.130, 221.5.88.88
Keepalive PING IP Address:	8.8.8.8, 8.8.4.4
Keepalive PING Interval:	30

Current WAN Link	
Item	Description
Current WAN Link	Show the current WAN link: Cellular WAN or Ethernet WAN.
IP Address	Show the current WAN IP address
Gateway	Show the current gateway
NetMask	Show the current netmask
DNS Server	Show the current primary DNS server and Secondary server
Keeping PING IP Address	Show the current ICMP detection server which you can set in "Configuration->Link Management".
Keeping PING Interval	Show the ICMP Detection Interval (s) which you can set in "Configuration->Link Management".

Cellular Information	
Current SIM:	SIM1
Phone No.:	
SMS Service Center:	8613010200500
Modem Status:	Ready
Network Status:	Registered to home network
Signal Level (RSSI):	 (20,-73DB)
PLMN:	China Unicom 3G (LAC: A50B / Cell ID: 148A98C)
Network Service Type:	3G HSDPA
IMEI/ESN:	351579052625397
IMSI:	460012054011892
APN:	3gnet
Username:	
Password:	
USB Status:	Ready

Cellular Information	
Item	Description
Current SIM	Show the SIM card which the router work with currently: SIM1 or SIM2
Phone No.	Show the phone number of the current SIM.
SMS Service Center	Show the SMS Service Center.
Modem Status	Show the status of modem. There are 8 different status: 1. Unknown. 2. Ready. 3. Checking AT. 4. Need PIN. 5. Need PUK. 6. Signal level is low. 7. No registered. 8. Initialize APN failed.
Network Status	Show the current network status. There are 6 different status: 1. Not registered, ME is currently not searching for new operator! 2. Registered to home network. 3. Not registered, but ME is currently searching for a new operator. 4. Registration denied. 5. Registered, roaming. 6. Unknown.
Signal Level (RSSI)	Show the current signal level.
PLMN	Show Mobile Country Code (MCC) +Mobile Network Code (MNC), e.g. 46001. Also it will show the Location Area Code (LAC) and Cell ID.
Network Service Type	Show the current network service type, e.g. GPRS.
IMEI/ESN	Show the IMEI/ESN number of the radio module.

IMSI	Show the IMSI number of the current SIM.
USB Status	Show the current status of USB host.

3.5 Status -> Network

This section displays the router's Network status, which include status of Cellular WAN, ETH0, ETH1, WLAN (AP mode)/WLAN (Client mode), DHCP and Device List.

Cellular WAN	
Connection Status:	Connected
Connect Time:	0 day 00:38:17
IP Address:	10.188.180.135
Gateway:	192.168.254.254
Primary DNS Server:	210.21.4.130
Secondary DNS Server:	221.5.88.88

LAN0	
IP Address:	172.31.99.7
MAC Address:	00:ff:74:46:cd:e7
MTU:	1500
NetMask:	255.255.0.0

LAN1	
IP Address:	192.168.10.1
MAC Address:	00:ff:74:46:dc:e2
MTU:	1500
NetMask:	255.255.255.0

Note: "Cellular WAN" information will not be shown if you select "Eth0" in "Configuration"->"Link Management"->"Link Management Settings" ->"Primary Interface".

WiFi	
MAC Address:	00:23:a7:40:12:58
SSID:	R3000
Mode:	AP
WPA State:	Completed

Note: This information will be shown when R3000 enable WiFi feature and works as AP mode.

WiFi WAN	
Connection Mode:	DHCP Client
IP Address:	192.168.253.6
MAC Address:	00:23:a7:40:12:58
Gateway:	192.168.253.1
NetMask:	255.255.255.0
Primary DNS Server:	192.168.253.1
Secondary DNS Server:	172.16.0.200

Note: This information will be shown when R3000 enable WiFi and works as Client mode.

Network	DHCP	Device List
---------	-------------	-------------

DHCP Lease List			
Dhcp Client Name	MAC Address	IP Address	Expired Time
Ben-PC	00:03:12:0d:1b:3a	192.168.10.2	15:07:55

Network	DHCP	Device List
---------	------	--------------------

Device List		
Interface	MAC Address	IP Address
lan0	f8:a9:63:bc:dc:32	172.31.2.59

3.6 Status -> Route

This section displays the router’s route table.

Route

Route Table				
Destination	NetMask	Gateway	Interface	Metric
0.0.0.0	0.0.0.0	192.168.254.254	ppp0	0
172.31.0.0	255.255.0.0	0.0.0.0	lan0	0
192.168.1.0	255.255.255.0	0.0.0.0	lan1	0
192.168.254.254	255.255.255.255	0.0.0.0	ppp0	0

3.7 Status -> VPN

This section displays the router’s VPN status, which includes IPsec, L2TP, PPTP, OpenVPN and GRE.

IPsec
L2TP
PPTP
OpenVPN
GRE

IPsec Status

No.	Tunnel name	Status	Connect Time

IPsec Detail Status

[Show Detail Status](#)

IPsec
L2TP
PPTP
OpenVPN
GRE

L2TP Client

No.	Tunnel name	Status	Local IP	Remote IP	Connect Time

L2TP Server

No.	Tunnel name	Status	Local IP	Remote IP	Connect Time

IPsec
L2TP
PPTP
OpenVPN
GRE

PPTP Client

No.	Tunnel name	Status	Local IP	Remote IP	Connect Time

PPTP Server

No.	Tunnel name	Status	Local IP	Remote IP	Connect Time

IPsec
L2TP
PPTP
OpenVPN
GRE

VPN Status

No.	Tunnel name	Status

IPsec
L2TP
PPTP
OpenVPN
GRE

GRE

No.	Tunnel name	Status	Local IP	Remote IP	Connect Time

3.8 Status -> Services

This section displays the router's Services' status, including VRRP, DynDNS, Serial and DI/DO.

VRRP
DynDNS
Serial
DI/DO

VRRP

VRRP is disabled!

VRRP
DynDNS
Serial
DI/DO

DynDNS

DynDNS is disabled!

VRRP
DynDNS
Serial
DI/DO

RS232: 115200, N, 8, 1

RS485: 115200, N, 8, 1

VRRP
DynDNS
Serial
DI/DO

DI

No.	Level	Status	Start Counter	Event Counter Value

DO

No.	Level	Status
1	Low	Alarm off
2	Low	Alarm off

DO Control

DO_1:

DO_2:

DI/DO	
Item	Description
DI	Show status of DI.
DO	Show status of DO.
DO Control	You can click button to change DO status of both DO_1 and DO_2 via web after you have enable DO in Configuration-> DI/DO-> DO-> DO Configuration -> Enable.

3.9 Status -> Event/Log

This section displays the router’s event/log information. You need to enable router to output the log and select the log level first, then you can view the log information here. Also you can click *Download System Diagnosing Data* to download diagnose data.

Event/Log

Event/Log Messages

Download: --Please Select-- ▼

Log Level: DEBUG ▼

```

13-08-30 17:15:17 <0> router: Firmware version: 1.01.00-sub-130829 Aug 29 2013 17:19:34
13-08-30 17:15:17 <0> router: start dhcpd
13-08-30 17:15:24 <0> router: open /dev/ttyUSB3 successful!
13-08-30 17:15:25 <0> router: sent:ATE0
13-08-30 17:15:25 <3> router: failed 1/5 to test AT command ATE0
13-08-30 17:15:26 <0> router: sent:ATE0
13-08-30 17:15:27 <0> router: rcvd:ATE0

OK
13-08-30 17:15:27 <0> router: sent:AT+CPIN?
13-08-30 17:15:27 <0> router: rcvd:
+CME ERROR: SIM busy
13-08-30 17:15:27 <3> router: failed 1/5 to check SIM card
13-08-30 17:15:32 <0> router: sent:AT+CPIN?
13-08-30 17:15:32 <0> router: rcvd:
+CPIN: READY

OK
13-08-30 17:15:33 <0> router: sent:AT+CFUN=1
13-08-30 17:15:33 <0> router: rcvd:
OK
13-08-30 17:15:33 <0> router: sent:ATIINTERCND="A710"
13-08-30 17:15:33 <0> router: rcvd:
                
```

Download System Diagnosing Data

Download System Diagnosing Data

Manual Refresh ▼
 Refresh
Clear

Event/Log	
Item	Description
Download	Select the log messages you want to download.
Log Level	Select the Log level in the drop-down menu: DEBUG, INFO, NOTICE, WARNING, ERR, CRIT, ALERT, EMERG.
Download System Diagnosing Data	Click <i>Download System Diagnosing Data</i> to download diagnose file.
Manual Refresh	Select from “5 Seconds”, “10 Seconds”, “15 Seconds”, “30 Seconds” and “1 Minute”. User can select these intervals to refresh the log information.

3.10 Configuration -> Link Management

This section allows users to set the WAN link and the related parameters.

Link Management

Link Management Settings

Primary Interface: Cellular ▾

Backup Interface: None ▾

ICMP Detection Primary Server: 8.8.8.8

ICMP Detection Secondary Server: 8.8.4.4

ICMP Detection Interval (s): 30

ICMP Detection Timeout (s): 3

ICMP Detection Retries: 3

Reset The Interface

**It is recommended to use an ICMP detection server to keep router always online.*

**The ICMP detection increases the reliability and also cost data traffic.*

**DNS example: Google DNS Server 8.8.8.8 and 8.8.4.4*

Link Management		
Item	Description	Default
Primary Interface	Selected from "Cellular", "Eth0", "WiFi". 1. Cellular: Select to make cellular as the primary WAN link. 2. Eth0: Select to make Eth0 as the primary WAN link. 3. WiFi: Select to make WiFi as the primary WAN link.	Cellular
Backup Interface	Selected from "None", "Eth0", "WiFi". 1. None: Do not select backup interface. 2. Cellular: Select Cellular as the backup WAN link. 3. Eth0: Select Eth0 as the backup WAN link. 4. WiFi: Select WiFi as the backup WAN link.	None
ICMP Detection Primary Server	Router will ping this primary address/domain name to check that if the current connectivity is active.	Null
ICMP Detection Secondary Server	Router will ping this secondary address/domain name to check that if the current connectivity is active.	Null
ICMP Detection Interval	Set the ping interval.	Null
ICMP Detection Timeout	Set the ping timeout.	30
ICMP Detection Retries	If Router ping the preset address/domain name time out continuously for Max Retries time, it will consider that the connection has been lost.	3
Reset The Interface	Enable to reset the cellular/ETH0 interface after the max ICMP detection retries.	3

3.11 Configuration -> Cellular WAN

This section allows users to set the Cellular WAN and the related parameters.

Note: This section will not be displayed if you select "Eth0 Only" in "Configuration"->"Link Management"->"WAN Link".

Basic
Advanced
ISP Profile

Cellular Settings

	SIM1	SIM2
Status:	Ready	Not inserted
Network Provider Type:	Auto ▼	Auto ▼
APN:	<input style="width: 100%;" type="text"/>	<input style="width: 100%;" type="text"/>
Username:	<input style="width: 100%;" type="text"/>	<input style="width: 100%;" type="text"/>
Password:	<input style="width: 100%;" type="text"/>	<input style="width: 100%;" type="text"/>
Dialup No.:	<input style="width: 100%;" type="text"/>	<input style="width: 100%;" type="text"/>
PIN Type:	None ▼	None ▼

Pppoe Bridge Setting

Enable Pppoe Bridge

Connection Mode

Connection Mode: Connect on demand ▼

Redial Interval (s):

Max Retries:

Inactivity Time (s):

Serial Output Content (Hex):

Triggered by Serial Data

Triggered by Tel

Triggered by SMS

SMS Connect command:

SMS disconnect command:

SMS connect reply:

SMS disconnect reply:

Phone Group: NULL ▼ Click to add PhoneGroup!

Triggered by IO (Note: use DI_1.)

Periodically connect

Time schedule: NULL ▼

Time Range

Name	SUN	MON	TUE	WED	THU	FRI	SAT	Time Range1	Time Range2	Time Range3
schedule_1	<input checked="" type="checkbox"/>	<input checked="" type="checkbox"/>	<input checked="" type="checkbox"/>	<input checked="" type="checkbox"/>	<input checked="" type="checkbox"/>	<input checked="" type="checkbox"/>	<input checked="" type="checkbox"/>	08:10-12:00	14:10-20:15	<input style="width: 100%;" type="text"/>

X
Add

Dual SIM Policy

Main SIM Card:

Switch To Backup SIM Card When Connection Fails

Switch To Backup SIM Card When ICMP Detection Fails

Total Ping (5~100)

Average Ping (100~5000ms)

Total Loss (0~100%)

Switch To Backup SIM Card When Roaming Is Detected

Preferred PLMN:

Switch To Backup SIM Card When IO Is Active (Note: use DI_2.)

Switch To Backup SIM Card When Data Limit Is Exceeded

When Both Data Limit Is Exceeded

Max Data Limitation (MB):

Date Of Month To Clean:

Already used (KB):

Switch Back Main SIM Card After Timeout

Initial Timeout (min):

Basic @Cellular WAN		
Cellular Settings		
Item	Description	Default
Network Provider Type	Select from "Auto", "Custom" or the ISP name you preset in "Configuration"->"Cellular WAN"->"ISP Profile". Auto: Router will get the ISP information from SIM card, and set the APN, username and password automatically. This option only works when the SIM card is from well-known ISP. Custom: Users need to set the APN, username and password manually.	Auto
APN	Access Point Name for cellular dial-up connection, provided by local ISP.	Null
Username	User Name for cellular dial-up connection, provided by local ISP.	Null
Password	Password for cellular dial-up connection, provided by local ISP.	Null
Dialup No.	Dialup number for cellular dial-up connection, provided by local ISP.	*99***1#
PIN Type	Select from "None", "Input", "Lock", "Unlock". None: Select when SIM card does not enable PIN lock or PUK lock. Input: Select when SIM card has enabled with PIN lock or PUK lock. Correct PIN/PUK code need to be entered. Lock: Select when user needs to lock the SIM card with PIN or PUK code. Unlock: Select when user needs to unlock the SIM card with PIN or PUK code. Note: Please ask your local GSM ISP to see whether your SIM card requiring PIN or not. <i>If you want to change with a new PIN code, you need to input new PIN</i>	None

	code in item "New PIN Code" and "Confirm New PIN Code". You can go to tab "Status" -> "Event/Log" and find out "AT+CPIN?" to check what the status of the SIM card is.	
PPPoE Bridge Setting		
Enable PPPoE Bridge	Click to enable PPPoE Bridge setting.	Disable
Connection Mode		
Connection Mode	Select from "Always Online" and "Connect On Demand". Always Online: Auto activates PPP and keeps the link up after power on. Connect On Demand: After selection this option, user could configure Triggered by Serial Data, Triggered by Periodically Connect and Triggered by Time Schedule. Note: If you select several connect on demand polices, router only have to meet one of them to be triggered.	Connect On Demand
Redial Interval	Router will automatically re-dial with this interval when it fails communicating to peer via TCP or UDP.	30
Max Retries	The maximum retries times for automatically re-connect when router fails to dial up. After maximum retries, router will reboot the wireless module. If router still cannot dial up successfully, it will try to switch to the other SIM card. Then router will re-connect with the other SIM card with maximum retries. After successful connection, the Max Retries counter will be set to 0.	3
Inactivity Time	Configurable after "Connect On Demand" was selected. This field specifies the idle time setting for GPRS/3G auto-disconnection and trying to revert back to preferred SIM card. 0 means timeless.	0
Serial Output Content	The content which output to the serial device which connect to router and inform it that router is ready to receive serial data.	Null
Triggered by Serial Data	Tick this check box to allow router automatically connects to cellular network from idle mode when there is data comes out from serial port.	Enable
Triggered by Tel	Tick this check box to allow router automatically connects to cellular network from idle mode when make a voice call to router.	Disable
Triggered by SMS	Tick this check box to allow router automatically connects to cellular network from idle mode when send a specific SMS to router.	Disable
SMS Connect Command	Users shall send this specific SMS to trigger router to connect to cellular network.	Null
SMS Disconnect Command	Users shall send this specific SMS to trigger router to disconnect to cellular network.	Null
SMS Connect Reply	When router connects to cellular network, it will automatically send out this SMS to specific users (set in the Phone Group).	Null
SMS Disconnect Reply	When router disconnect from cellular network, it will automatically send out this SMS to specific users (set in the Phone Group).	Null
Phone Group	Click to add Phone Group to Set specific users' phone Book and which phone Group they are belonged to.	Null

Triggered by IO	Tick this check box to allow router automatically connects to cellular network from idle mode when there is a DI (DI_1) alarm input.	Disable
Periodically Connect	Tick this check box to allow router automatically connects to cellular network with preset interval which you preset in <i>Periodically Connect Interval</i> .	Enable
Periodically Connect Interval	Periodically Connect Interval for Periodically Connect.	300
Time Schedule	Select the Time Range to allow router automatically connects to cellular network during this time range.	NULL
Time Range	Adding the Time Range for Time Schedule. You can set the days of one week and at most three ranges of time of one day.	Null
Dual SIM Policy		
Main SIM Card	Set the preferred SIM card from SIM 1, SIM 2 or Auto.	SIM1
Switch to backup SIM card when connection fails	Router will switch to another SIM card if main SIM card fail to connect to network.	Disable
Switch To Backup SIM Card When ICMP Detection Fails	Router will switch to another SIM card if it cannot dialup or ping the preset address timeout continuously for Max Retries time. Preset address is set in Configuration-> Link Management-> ICMP Detection Primary Server and ICMP Detection Secondary Server. Important Note: You need to fill in tab Configuration-> Link Management-> ICMP Detection Primary Server and ICMP Detection Secondary Server, and then this strategy can be activated.	Disable
Total Ping (5~100) @ Switch To Backup SIM Card When ICMP Detection Fails	Preset Max Retries time that Router ping the preset address/domain name.	10
Average Ping (100~5000ms) @ Switch To Backup SIM Card When ICMP Detection Fails	Route will count the "Average Ping" timeout interval after router ping the preset address/domain name for "Total Ping" times. After router detects that average ping timeout interval reach to preset "Average Ping" it will switch backup SIM card.	400
Total Loss (0~100%) @ Switch To Backup SIM Card When ICMP Detection Fails	Route will count the "Total Loss" after router ping the preset address/domain name for "Total Ping" times. After router detects that total loss packet reach to preset "Total Loss" it will switch backup SIM card.	30
Switch to backup SIM card when roaming is detected	Router will switch to backup SIM card when preferred SIM card is roaming.	Disable
Preferred PLMN	The identifier for Router to check if it is in home location area or in roaming area, and decide if it needs to switch back to preferred SIM card.	Null
Switch to backup SIM card when IO is active	Router will switch to another SIM card if it detect there is DI (DI_2) alarm input.	Disable

Switch to backup SIM card when data limit is exceeded	If the SIM card that the router worked with currently has reached the data traffic limitation you preset, it will switch to the other SIM card.	Disable
When Both Data Limit Is Exceeded	Select from "Stay in Backup SIM Card", "Switch Back Main SIM Card" and "Disable Cellular Until Data Is Cleared".	Disable
Max Data limitation(MB)	Set the monthly data traffic limitation.	100
Date of Month to Clean	Set one day of month to restore the used data to 0.	1
Already used	This tab will show how many data traffic has been used.	0
Switch back Main SIM card after timeout(min)	Enable to Switch back Main SIM card after the Initial timeout.	Disable
Initial Timeout(min)	Set the initial timeout.	60

Note: This section will not be displayed if you select "Eth0 Only" in "Configuration"->"Link Management"->"WAN Link".

- Basic
- Advanced
- ISP Profile

Cellular Advanced Settings

	SIM1	SIM2
Phone No.:	<input type="text"/>	<input type="text"/>
Network Type:	<input type="text" value="Auto"/> ▼	<input type="text" value="Auto"/> ▼
Band Mode:	<input type="text" value="ALL"/> ▼	<input type="text" value="ALL"/> ▼
Authentication:	<input type="text" value="Auto"/> ▼	<input type="text" value="Auto"/> ▼
MTU:	<input type="text" value="1500"/>	<input type="text" value="1500"/>
MRU:	<input type="text" value="1500"/>	<input type="text" value="1500"/>
Asynmap Value:	<input type="text" value="ffffffff"/>	<input type="text" value="ffffffff"/>
Use Peer DNS:	<input checked="" type="checkbox"/>	<input checked="" type="checkbox"/>
Primary DNS Server:	<input type="text"/>	<input type="text"/>
Secondary DNS Server:	<input type="text"/>	<input type="text"/>
Address/Control Compression:	<input checked="" type="checkbox"/>	<input checked="" type="checkbox"/>
Protocol Field Compression:	<input checked="" type="checkbox"/>	<input checked="" type="checkbox"/>
Expert Options:	<input type="text" value="noccp nobsdcomp"/>	<input type="text" value="noccp nobsdcomp"/>

Advanced @Cellular WAN		
Item	Description	Default
Phone No.	Set the SIM card's phone number, and it will be showed in "Status"->"System"->"System"->"Cellular WAN Information"->"SIM Phone Number". In general, you don't need to set this number because router will read it from the SIM card automatically.	Null
Authentication	Select from "Auto", "PAP" and "CHAP" as the local ISP required.	Auto
MTU	Maximum Transmission Unit. It is the identifier of the maximum size of packet, which is possible to transfer in a given environment.	1500
MRU	Maximum Receiving Unit. It is the identifier of the maximum size of packet, which is possible to receive in a given environment.	1500
Asyncmap Value	One of the PPP initialization strings. In general, you don't need to modify this value.	1
Use Peer DNS	Enable to obtain the DNS server's address from the ISP.	Enable
Primary DNS Server	Set the primary DNS server's address. This item will be unavailable if you enable "Use Peer DNS".	Null
Secondary DNS Server	Set the secondary DNS server's address. This item will be unavailable if you enable "Use Peer DNS".	Null
Address/Control Compression	Used for PPP initialization. In general, you need to enable it as default.	Enable
Protocol Field Compression	Used for PPP initialization. In general, you need to enable it as default.	Enable
Expert Options	You can enter some other PPP initialization strings in this field. Each string can be separated by a space.	noccp nobsdcom p

ISP Profile

This section allow users to preset some ISP profiles which will be shown in the selection list of "Configuration"->"Cellular WAN"->"Network Provider Type".

Basic	Advanced	ISP Profile										
<p>ISP Profile List</p> <table border="1"> <thead> <tr> <th>ISP</th> <th>APN</th> <th>Username</th> <th>Password</th> <th>Dialup No.</th> </tr> </thead> <tbody> <tr> <td>china-mobile</td> <td>3gnet</td> <td></td> <td></td> <td>*99***1#</td> </tr> </tbody> </table> <p style="text-align: right;"><input type="button" value="Add"/> ✘</p>			ISP	APN	Username	Password	Dialup No.	china-mobile	3gnet			*99***1#
ISP	APN	Username	Password	Dialup No.								
china-mobile	3gnet			*99***1#								

ISP Profile @Cellular WAN		
Item	Description	Default
ISP	Input the ISP's name which will be shown in the selection list of "Configuration"->"Cellular WAN"->"Network Provider Type".	Null
APN,Username, Password, Dialup No.	All these parameters were provided by the ISP.	Null

3.12 Configuration -> Ethernet

This section allows users to set the Ethernet WAN and LAN parameters of Eth0.

Eth0
Eth1
VLAN
Dhcp Relay

Ethernet Interface Type

LAN
 WAN

LAN Interface

Enable Bridge (As 2 Ports Switch)

IP Address:

NetMask:

MTU:

Media Type:

LAN Interface

Enable Bridge (As 2 Ports Switch)

IP Address:

NetMask:

MTU:

Multiple IP Address

IP Address	NetMask

DHCP Server

Enable DHCP Server

IP Pool Start:

IP Pool End:

NetMask:

Lease Time (min):

Primary DNS Server:

Secondary DNS Server:

Windows Name Server:

Static Lease

MAC Address	IP Address
*MAC: ff:ff:ff:ff:ff:ff	

Eth0@Ethernet		
Item	Description	Default
Ethernet Interface Type	Eth0 can work under two different kinds of mode: LAN and WAN.	LAN
Enable Bridge @ LAN Interface	Enable to make Eth0 works under bridge mode with Eth1. Eth0 and Eth1 will have the same IP address under this mode.	Enable
IP Address, Netmask, MTU, Media Type@ LAN Interface	Set the IP address, Netmask, MTU and Media Type of Eth0. These parameters will be un-configurable if you enable Bridge.	Null
Multiple IP Address @ LAN Interface	Assign multiple IP addresses for Eth0.	Null
Enable DHCP Server @ DHCP Server	Enable to make router can lease IP address to DHCP clients which connect to Eth0.	Disable
IP Pool Start, IP Pool End @ DHCP Server	Define the beginning (IP Pool Start) and end (IP Pool End) of the pool of IP addresses which will lease to DHCP clients.	Null
Netmask @ DHCP Server	Define the Netmask which the DHCP clients will obtain from DHCP server.	Null
Lease Time @ DHCP Server(min)	Define the time which the client can use the IP address which obtained from DHCP server.	60
Primary/Secondary DNS Server @ DHCP Server	Define the primary/secondary DNS Server which the DHCP clients will obtain from DHCP server.	Null
Windows Name Server @ DHCP Server	Define the WINS Server which the DHCP clients will obtain from DHCP server.	Null
Static Lease @ DHCP Server	Define to lease static IP Addresses, which conform to MAC Address of the connected equipment.	Null

This section allows users to set the Ethernet WAN and LAN parameters of Eth1.

Eth0
Eth1
VLAN
Dhcp Relay

LAN Interface

IP Address:	<input style="width: 90%;" type="text" value="192.168.0.1"/>
NetMask:	<input style="width: 90%;" type="text" value="255.255.255.0"/>
MTU:	<input style="width: 90%;" type="text" value="1500"/>
Media Type:	<input style="width: 90%;" type="text" value="Auto-negotiation"/>

Multiple IP Address

<input style="width: 95%;" type="text" value="IP Address"/>	<input style="width: 95%;" type="text" value="NetMask"/>	
		<input type="button" value="Add"/>

DHCP Server

Enable DHCP Server

IP Pool Start:

IP Pool End:

NetMask:

Lease Time (min):

Primary DNS Server:

Secondary DNS Server:

Windows Name Server:

Static Lease

MAC Address	IP Address
<i>*MAC: ff:ff:ff:ff:ff:ff</i>	

Eth1@Ethernet		
Item	Description	Default
IP Address, Netmask, MTU, Media Type @ LAN Interface	Set the IP address, Netmask, MTU and Media Type of Eth1. These parameters will be un-configurable if you enable Bridge.	Null
Multiple IP Address @ LAN Interface	Assign multiple IP addresses for Eth1.	Null
Enable DHCP Server @ DHCP Server	Enable to make router can lease IP address to DHCP clients which connect to Eth1.	Enable
IP Pool Start, IP Pool End @ DHCP Server	Define the beginning (IP Pool Start) and end (IP Pool End) of the pool of IP addresses which will lease to DHCP clients.	192.168.0.2/ 192.168.0.100
Netmask @ DHCP Server	Define the Netmask which the DHCP clients will obtain from DHCP server.	255.255.255.0
Lease Time @ DHCP Server(min)	Define the time which the client can use the IP address which obtained from DHCP server.	60
Primary/Secondary DNS Server @ DHCP Server	Define the primary/secondary DNS Server which the DHCP clients will obtain from DHCP server.	192.168.0.1/ 0.0.0.0
Windows Name Server @ DHCP Server	Define the WINS Server which the DHCP clients will obtain from DHCP server.	192.168.0.1
Static Lease @ DHCP Server	Define to lease static IP Addresses, which conform to MAC Address of the connected equipment.	Null

Router can be DHCP Relay, which will provide a relay tunnel to solve problem that DHCP Client and DHCP Server is not in a same subnet. This section allow user to configure DHCP Relay settings.

- Eth0
- Eth1
- VLAN
- Dhcp Relay

LAN0 VLAN Settings

LAN0 VLAN Enable

LAN1 VLAN Settings

LAN1 VLAN Enable

VLAN @ Ethernet		
Item	Description	Default
LAN 0/1 VLAN Enable	Enable to make router can encapsulate and de-encapsulate the VLAN tag.	Disable
VLAN ID@LAN 0/1 VLAN Enable	Set the Tag ID of VLAN	Null
IP Address, NetMask @LAN0/1 VLAN Settings	Set the IP address, Netmask of VLAN interface	VLAN 0/1's IP address, Netmask

Note: IP Address and NetMask will be hidden if user bridge two Ethernet ports.

Router can be DHCP Relay, which will provide a relay tunnel to solve problem that DHCP Client and DHCP Server is not in a same subnet. This section allow user to configure DHCP Relay settings.

- Eth0
- Eth1
- VLAN
- Dhcp Relay

DhcpRelay Configuration

Enable Dhcp Relay

DHCP Relay@Ethernet		
Item	Description	Default
DHCP Server	Enter DHCP Server's IP address. Note: Please disable DHCP Server and DHCP Client first to make sure DHCP relay can be enabled.	Null

3.13 Configuration -> WiFi

This section allows users to set parameters of WiFi.

Basic
MAC Filter
Status

WiFi Basic Settings

Enable WiFi

Mode: AP

Channel: Auto

SSID: Router_AP

Hide SSID:

Security Mode: Open

WiFi Network Settings

**WiFi interface bridged with eth1, network settings please refer to this page.*

Note: when R3000 enable WiFi feature and works as AP mode

Basic
Status

WiFi Basic Settings

Enable WiFi

Mode: Client

Channel: Auto

SSID: Router_AP Scan

Hide SSID:

Security Mode: Open

WiFi Network Settings

IP Configuration: DHCP Client

Use Peer DNS

Override DHCP Server Values:

Netmask:

Gateway:

Note: when R3000 enable WiFi feature and works as Client mode

Basic @ WiFi		
Item	Description	Default
Enable WiFi	Click to enable WiFi feature.	Null
Mode	<p>This item will show "AP" and "Client", cannot be configured.</p> <p>AP: In a wireless local area network (WLAN), an access point is a station that transmits and receives data. When R3000 is wanted to work as "AP" mode, please go to tab "Configuration" -> "Link Management" -> "Primary Interface" to select "Cellular" or "Eth0" as WAN link.</p> <p>Client: When R3000 works as Client mode, it can be used as an Ethernet-to-wireless (or LAN-to-WLAN) network adaptor. For example, a notebook computer equipped with an Ethernet adaptor but no wireless card can be connected to the router with an Ethernet cable to provide wireless connectivity to another AP. When R3000 is wanted to work as "Client" mode, please go to tab "Configuration" -> "Link Management" -> "Primary Interface" to select "WiFi" as WAN link.</p>	Null
Channel	<p>Select the frequency channel, which includes "Auto", "1", "2" "13".</p> <p>Auto: R3000 will scan all frequencies until it finds one with an available access point or wireless network it can join.</p> <p>1~13: R3000 will be fixed to work with this channel.</p>	Auto
SSID	<p>SSID (service set identifier) is the network name of the WLAN. The SSID of a client and the SSID of the AP must be identical for the client and AP to be able to communicate with each other.</p> <p>When R3000 works as Client mode, enter SSID of the access point which R3000 want to connect.</p> <p>Input from 1 to 31 characters.</p>	Router_AP
Hide SSID	<p>When R3000 works as AP mode, after clicking this check box R3000 will not broadcast the SSID. Other wireless devices cannot discover this access point automatically. User need to enter the SSID manually to let their wireless devices join this access point.</p> <p>When R3000 works as Client mode and need to connect to any access point which has ensconced SSID, you need to enter this SSID manually in tab "SSID" and then click "Hide SSID".</p>	Disable

Security mode	<p>Select from “Open”, “WPA”, “WPA2” and “WEP”.</p> <p>Open: No authentication. For security reasons, you should NOT set security mode to Open System, since authentication and data encryption are NOT performed in Open System mode.</p> <p>WPA/WPA2: Personal versions of WPA/WPA2 (Wi-Fi Protected Access), also known as WPA/WPA-PSK (Pre-Shared Key), provide a simple way of encrypting a wireless connection for high confidentiality. WPA2 is a stronger security feature than WPA.</p> <p>WEP: Wired Equivalent Privacy, provide encryption for wireless device’s data transmission.</p> <p>Note: R3000 supports WPA/WPA2 Personal version, not enterprise version.</p>	Open
Encryption	<p>Select from “TKIP” and “CCMP (AES)”.</p> <p>TKIP: Temporal Key Integrity Protocol (TKIP) encryption is used over the wireless link. TKIP encryption can be used with WPA-PSK and WPA with 802.1x authentication.</p> <p>CCMP (AES): CCMP (AES) encryption is used over the wireless link. CCMP can be used WPA-PSK and WPA with 802.1x authentication.</p> <p>Note: CCMP (AES) is a stronger encryption algorithm than TKIP.</p>	CCMP (AES)
Passphrase	<p>When R3000 works as AP mode, enter Master key to generate keys for encryption. A Passphrase is used as a basis for encryption methods (or cipher types) in a WLAN connection. The passphrases should be complicated and as long as possible. For security reasons, this passphrase should only be disclosed to users who need it, and it should be changed regularly.</p> <p>When R3000 works as Client mode, enter access point’s passphrase which it wants to connect to.</p> <p>Input from 8 to 63 characters.</p>	Null
Key Renewal Interval(s)	<p>Enter the time period of group key renewal.</p> <p>Note: Only for AP mode.</p>	3600
WiFi Network Settings	<p>When R3000 works as AP mode, Click to link to page “Eth1” to check the network settings, WiFi interface bridged with eth1 this time.</p> <p>When R3000 works as Client mode, this item is used to do IP configuration of access point.</p>	Null

Basic **MAC Filter** Status

MAC Filter Settings

Enable ACL:

Mode: Allow ▼

Access Control List

Index	MAC Address
<input type="button" value="Add"/>	

Note: Available when R3000 enable WiFi feature and works as AP mode

Mac Filter @ WiFi (Only for AP mode)		
Enable ACL	Click to enable ACL (Access Control List).	Disable
Mode	Select from "Allow" and "Deny". Allow: Only the packets fitting the entities of the "Access Control List" can be allowed. Deny: All the packets fitting the entities of the "Access Control List" will be denied. Note: R3000 can only allow or deny devices which are included in "Access Control List" at one time.	Allow
Access Control List	Click "Add" to add MAC address.	Null

Basic MAC Filter **Status**

Status

BSSID: 00:23:a7:40:12:58
 SSID: TP-Link8888
 Mode: AP
 Key Management: WPA2-PSK
 Cipher Pairwise: CCMP
 Cipher Group: CCMP
 WPA State: Completed
 Address: 00:23:a7:40:12:58

Associated Clients

Index	BSSID	IP Address

Status @ WiFi		
BSSID	Show MAC address of R3000's WiFi interface or the access point which R3000 connects to.	Null
SSID	Show SSID of R3000's WiFi interface or the access point which R3000 connects to.	Null
Mode	Show current mode of R3000: AP or Client.	Null
Key Management	Show current security mode of R3000 or the access point which R3000 connects to.	Null
Cipher Pairwise	Show current encryption algorithm of R3000 or the access point which R3000 connects to.	Null
Cipher Group		
WPA State	Show current WPA status. Mainly there are 5 statuses: Disconnected, Scanning, Initializing, Associated, 4way_handshark, Completed. Disconnected: Not associated or connected with any access point, perhaps because the wireless device has not fully initialized, is out of range, or the wireless interface is disconnected because the Ethernet interface is enabled.	Null

	<p>Scanning: Searching for a wireless network (access point) for connection.</p> <p>Initializing: R3000 is setting up initial wireless environment.</p> <p>Associated: This state is entered when the driver reports that association has been successfully completed with an AP, but still waiting for authentication.</p> <p>4way_handshake: This state is entered when WPA/WPA2 4-Way Handshake is started. When Passphrase do not match, it will show this status.</p> <p>Completed: The wireless connection of R3000 and other wireless devices are established.</p>	
Address	Show the MAC address of R3000's WiFi interface.	Null
Associated Clients @ AP mode	Show current associated wireless client devices' BSSID and IP address.	Null
Scan Results @ Client mode	Show current scan results of any wireless network (access point), such as SSID, Channel, Signal Level, Flags (the security mode and encryption algorithm flags of access point).	Null

3.14 Configuration -> Serial

This section allows users to set the serial (RS232/RS485) parameters.

RS232
RS485

Serial Port Settings

Baudrate:

Data Bit:

Parity:

Stop Bit:

Flow Control:

Protocol Settings

Protocol:

- When Select Protocol "Transparent":

Protocol Settings

Protocol:

Mode:

Local Port:

Show Protocol Advanced

Interval Timeout (1*10ms):

Packet Length:

Enable Delimiter1

Delimiter1 (Hex):

Enable Delimiter2

Delimiter2 (Hex):

Delimiter Process:

- When Select Protocol “Modbus”:

Protocol Settings

Protocol:

Local Port:

Attached serial device type:

Modbus Slave

Slave Address	Slave Port	ID
*ID: <1-247> or <1-247>-<1-247>		
<input type="button" value="Add"/>		

- When Select Protocol “Transparent Over Rlink”:

Protocol Settings

Protocol:

Interval Timeout (1*10ms):

- When Select Protocol “Modbus Over Rlink”:

Protocol Settings

Protocol:

Attached serial device type:

- When Select Protocol “AT Over COM”:

Protocol Settings

Protocol:

Display all com (Note enable this function will disable cellular WAN.)

COM Name:

● When Select Protocol “GPS Report”:

Protocol Settings	
Protocol:	GPS Report

RS232 @ Serial		
Item	Description	Default
Baud-rate	Select from “300”, “600”, “1200”, “2400”, “4800”, “9600”, “19200”, “38400”, “57600”, “115200” and “230400”.	115200
Data bit	Select from “7” and “8”.	8
Parity	Select from “None”, “Odd” and “Even”.	None
Stop bit	Select from “1” and “2”.	1
Flow control	Select from “None”, “Software” and “Hardware”.	None
Protocol	<p>Select from “None”, “Transparent”, “Modbus”, “Transparent Over Rlink”, “Modbus Over Rlink” “AT Over COM” and “GPS Report”.</p> <ol style="list-style-type: none"> None: Router will do nothing in RS232 serial port. Transparent: Router will transmit the serial data transparently without any protocols. Modbus: Router will translate the Modbus RTU data to Modbus TCP data and vice versa. Transparent Over Rlink: Router will send all data from RS232 serial port to Robustlink, then Robustlink will forward the data to another destination site. Modbus Over Rlink: Router will translate all data from RS232 serial port to Modbus TCP protocol data, and then send to Robustlink, after that Robustlink will forward the data to another destination site. AT Over COM: select to operate router via RS232 COM port. For example, enter AT commands to router via RS232 COM port. GPS Report: select to enable router to output GPS status data through RS232 port. 	None
Mode @Transparent	<p>Select from “TCP Server”, “TCP Client” and “UDP”.</p> <p>TCP Client: Router works as TCP client, initiate TCP connection to TCP server. Server address supports both IP and domain name.</p> <p>TCP Server: Router works as TCP server, listening for connection request from TCP client.</p> <p>UDP: Router works as UDP client.</p>	TCP Client
Local Port @Transparent	Enter the Local port for TCP or UDP.	0
Multiple Server @Transparent	<p>Click “Add” button to add multiple server. You need to enter the server’s IP and port, and enable or disable “Send data to serial”. If you disable “Send data to serial”, router will not transmit the data from this server to serial port.</p> <p>Note: This section will not be displayed if you select “TCP server” in “Mode”.</p>	None
show Protocol	Tick to enable protocol advanced setting.	Disable

Advanced @ Transparent		
Local IP @ Transparent	This item will show up when you enable any VPN tunnel of R3000, it means serial data can be matched to this local IP address and be transmitted or received via VPN tunnel. Note: when you do not enable any VPN tunnel, this item will not show up.	Null
Interval Timeout @Transparent	The serial port will queue the data in the buffer and send the data to the Cellular WAN/Ethernet WAN when it reaches the Interval Timeout in the field. Note: Data will also be sent as specified by the packet length or delimiter settings even when data is not reaching the interval timeout in the field.	10
Packet Length @Transparent	The Packet length setting refers to the maximum amount of data that is allowed to accumulate in the serial port buffer before sending. 0 for packet length, no maximum amount is specified and data in the buffer will be sent as specified by the interval timeout or delimiter settings or when the buffer is full. When a packet length between 1 and 1024 bytes is specified, data in the buffer will be sent as soon it reaches the specified length. Note: Data will also be sent as specified by the interval timeout or delimiter settings even when data is not reaching the preset packet length.	1360
Enable Delimiter1/2	When Delimiter 1 is enabled, the serial port will queue the data in the buffer and send the data to the Cellular WAN/Ethernet WAN when a specific character, entered in hex format, is received. A second delimiter character may be enabled and specified in the Delimiter 2 field, so that both characters act as the delimiter to control when data should be sent.	Disable
Delimiter1/2 (Hex) @Transparent	Enter the delimiter in Hex.	0
Delimiter Process @Transparent	The Delimiter process field determines how the data is handled when a delimiter is received. None: Data in the buffer will be transmitted when the delimiter is received; the data also includes the delimiter characters. Strip: Data in the buffer is first stripped of the delimiter before being transmitted.	Strip
Local IP @ Modbus	This item will show up When you enable any VPN tunnel of R3000, it means serial data can be matched to this local IP address and be transmitted or received via VPN tunnel. Note: when you do not enable any VPN tunnel, this item will not show up.	0
Local Port @ Modbus	Enter the Local port for Modbus.	0
Attached serial device type @Modbus	Select From “Modbus RTU slave”, “Modbus ASC II slave”, “Modbus RTU master” and “Modbus ASC II master”. Modbus RTU slave: router connects to Modbus slave device which works under Modbus RTU protocol. Modbus ASC II slave: router connects to Modbus slave device which works under Modbus ASC II protocol.	Modbus RTU slave

	<p>Note: When select “Modbus RTU slave” and “Modbus ASC II slave” protocol, router is as TCP Server site, user need to enter a local port number in “Local Port @Modbus” and wait to be connected.</p> <p>Modbus RTU master: router connects to master device which works under Modbus RTU protocol.</p> <p>Modbus ASC II master: router connects to master device which works under Modbus ASC II protocol.</p> <p>Note: When select “Modbus RTU master” and “Modbus ASC II master” protocol, router is as TCP Client site, user need to enter slave address and slave port number in “Slave Address @ Modbus Slave ” and “Slave Port @ Modbus Slave”, and connect to Server site.</p>	
Modbus Slave @Modbus	Add the Modbus slaves which will be polled by Modbus master (router). This section only displayed when you select “Modbus RTU master” or “Modbus ASC II master” in “Attached serial device type”.	Null
Slave Address @ Modbus Slave	This connection is usually used to connect to the Modbus slave devices which as TCP server. Enter IP address of the TCP server.	Null
Slave Port @ Modbus Slave	Enter the port number of TCP server.	Null
ID @ Modbus Slave	Enter the ID number of TCP server.	Null
Interval Timeout @ Transparent Over Rlink	The serial port will queue the data in the buffer and send the data to the Cellular WAN/Ethernet WAN when it reaches the Interval Timeout in the field.	10
Attached serial device type @ Modbus Over Rlink	Select From “Modbus RTU slave”, “Modbus ASC II slave”. Modbus RTU slave: router connects to slave device which works under Modbus RTU protocol. Modbus ASC II slave: router connects to slave device which works under Modbus ASC II protocol.	Null
Display all com @ AT Over COM	Enable to display all virtual com of the module inside the router. Generally, router will occupy /dev/ttyUSB0 and /dev/ttyUSB2 for dialing up to GPRS. Note: Enable this function will disable Cellular WAN function.	Disable
COM Name	Show the virtual com name of the module inside.	/dev/ttyUSB1

RS232 **RS485**

Serial Port Settings

Baudrate: 115200 ▼

Data Bit: 8 ▼

Parity: None ▼

Stop Bit: 1 ▼

Protocol Settings

Protocol: None ▼

- When Select Protocol “Transparent”:

Protocol Settings

Protocol:

Mode:

Local Port:

Show Protocol Advanced

Interval Timeout (1*10ms):

Packet Length:

Enable Delimiter1

Delimiter1 (Hex):

Enable Delimiter2

Delimiter2 (Hex):

Delimiter Process:

- When Select Protocol “Modbus”:

Protocol Settings

Protocol:

Local Port:

Attached serial device type:

- When Select Protocol “Transparent Over Rlink”:

Protocol Settings

Protocol:

Interval Timeout (1*10ms):

- When Select Protocol “Modbus Over Rlink”:

Protocol Settings

Protocol:

Attached serial device type:

RS485 @ Serial		
Item	Description	Default
Baud-rate	Select from “300”, “600”, “1200”, “2400”, “4800”, “9600”, “19200”, “38400”, “57600”, “115200” and “230400”.	115200
Data bit	Select from “7” and “8”.	8
Parity	Select from “None”, “Odd” and “Even”.	None
Stop bit	Select from “1” and “2”.	1
Protocol	Select from “None”, “Transparent” and “Modbus”.	Transparent

	Transparent: Router will transmit the serial data transparently without any protocols. Modbus: Router will transmit the serial data with Modbus protocol.	
Mode @Transparent	Select from "TCP Server", "TCP Client" and "UDP".	TCP Client
Local Port @Transparent	Enter the Local port for TCP or UDP.	0
Multiple Server @Transparent	Click "Add" button to add multiple server. You need to enter the server's IP and port, and enable or disable "Send data to serial". If you disable "Send data to serial", router will not transmit the data from this server to serial port. Note: This section will not be displayed if you select "TCP server" in "Mode".	Null
Enable Protocol @Transparent	Tick to enable protocol advanced setting.	Disable
Local IP @ Transparent	This item will show up When you enable any VPN tunnel of R3000, it means serial data can be matched to this local IP address and be transmitted or received via VPN tunnel. Note: when you do not enable any VPN tunnel, this item will not show up.	0
Interval Timeout @Transparent	The serial port will queue the data in the buffer and send the data to the Cellular WAN/Ethernet WAN when it reaches the Interval Timeout in the field. Note: Data will also be sent as specified by the packet length or delimiter settings even when data is not reaching the interval timeout in the field.	10
Packet Length @Transparent	The Packet length setting refers to the maximum amount of data that is allowed to accumulate in the serial port buffer before sending. 0 for packet length, no maximum amount is specified and data in the buffer will be sent as specified by the interval timeout or delimiter settings or when the buffer is full. When a packet length between 1 and 1024 bytes is specified, data in the buffer will be sent as soon it reaches the specified length. Note: Data will also be sent as specified by the interval timeout or delimiter settings even when data is not reaching the preset packet length.	1360
Enable Delimiter1	When Delimiter 1 is enabled, the serial port will queue the data in the buffer and send the data to the Cellular WAN/Ethernet WAN when a specific character, entered in hex format, is received. A second delimiter character may be enabled and specified in the Delimiter 2 field, so that both characters act as the delimiter to control when data should be sent.	Disable
Delimiter1 (Hex) @ Transparent	Enter the delimiter in Hex.	0
Delimiter Process @ Transparent	The Delimiter process field determines how the data is handled when a delimiter is received. None: Data in the buffer will be transmitted when the delimiter is	Strip

	received; the data also includes the delimiter characters. Strip: Data in the buffer is first stripped of the delimiter before being transmitted.	
Local IP @ Modbus	This item will show up When you enable any VPN tunnel of R3000, it means serial data can be matched to this local IP address and be transmitted or received via VPN tunnel. Note: when you do not enable any VPN tunnel, this item will not show up.	0
Local Port @ Modbus	Enter the Local port for Modbus.	0
Attached serial device type @ Modbus	Select From “Modbus RTU slave”, “Modbus ASC II slave”, “Modbus RTU master” and “Modbus ASC II master”. Modbus RTU slave: router connects to slave device which works under Modbus RTU protocol. Modbus ASC II slave: router connects to slave device which works under Modbus ASC II protocol. Modbus RTU master: router connects to master device which works under Modbus RTU protocol. Modbus ASC II master: router connects to master device which works under Modbus ASC II protocol.	Modbus RTU slave
Modbus Slave @ Modbus	Add the Modbus slaves which will be polled by Modbus master (router). This section only displayed when you select “Modbus RTU master” or “Modbus ASCII master” in “Attached serial device type”.	Null
Slave Address @ Modbus Slave	This connection is usually used to connect to the Modbus slave devices which as TCP server. Enter IP address of the TCP server.	Null
Slave Port @ Modbus Slave	Enter the port number of TCP server.	Null
ID @ Modbus Slave	Enter the ID number of TCP server.	Null
Interval Timeout @ Transparent Over Rlink	Serial port will queue the data in buffer and then send it to the Cellular WAN/Ethernet WAN when it reaches the Interval Timeout in this field.	10
Attached serial device type @ Modbus Over Rlink	Select From “Modbus RTU slave”, “Modbus ASC II slave”. Modbus RTU slave: router connects to slave device which works under Modbus RTU protocol. Modbus ASC II slave: router connects to slave device which works under Modbus ASC II protocol.	Modbus RTU slave

3.15 Configuration -> DI/DO

This section allows users to set the DI/DO parameters.

DI
DO

DI_1 Configuration

Enable DI

Mode: OFF ▼

Filtering (1*100ms): 1

SMS Alarm

Triggering Alarm
Recovering Alarm
Phone Group

Add

DI_2 Configuration

Enable DI

Mode: OFF ▼

Filtering (1*100ms): 1

SMS Alarm

Triggering Alarm
Recovering Alarm
Phone Group

Add

DI @ DI/DO		
Item	Description	Default
Enable DI	Click to Enable DI.	Disable
Mode	Select from "OFF", "ON", "EVENT_COUNTER". OFF: Connect to GND (logic 0). When pin DI connects to GND, R3000 will detect there is a DI alarm input. ON: Open from GND (logic 1). When pin DI does not connect to GND, R3000 will detect there is a DI alarm input. EVENT_COUNTER: under event counter mode.	OFF
Filtering	Software filtering is used to control switch bounces. Input from 0 to 10000ms.	1
Count Trigger	Available when DI under Event Counter mode. Input from 0 to 100. (0=will not trigger alarm) It will trigger alarm when counter reaches this figure. After triggering alarm, DI will keep counting but not trigger alarm again.	0
Counter Active	Available when DI under Event Counter mode. Select from "Hi to Lo", "Lo to Hi". In Event Counter mode, the channel accepts limit or proximity switches and counts events according to the ON/OFF status. When "Lo to Hi" is selected,	Lo to Hi

	the counter value increases when the attached switch is pushed. When “Hi to Lo” is selected, the counter value increases when the switch is pushed and released.	
Counter Start When Power On	Available when DI under Event Counter mode. Start counting as soon as possible on the modem when enable this option. When R3000 need to work under Event Counter mode, user shall enable “Counter Start When Power On”. If “Counter Start When Power On” is disabled, it will also start counting when receiving SMS command. Refer to another document <i>SMS command of R3000</i> .	Disable
Triggering Alarm	The SMS to receive upon triggering alarm. (70 ASCII char max)	Null
Recovering Alarm	The SMS to receive upon recovering alarm. (70 ASCII char max)	Null
Phone Group	The alarm SMS will send to specified phone group. Each phone group include up to 10 phone numbers.	Null

DI **DO**

DO Configuration

Item	Description
DO_1	Enable:false;
DO_2	Enable:false;

DO Configuration

Enable

Alarm Source:

DI Alarm SMS Control Call Control

DO Action:

Alarm On Action:

Alarm Off Action:

Status When Power On:

Keep On (s):

DO @ DI/DO		
Item	Description	Default
Enable	Click to enable DO.	Disable
Alarm Source	Digital Output initiates according to different alarm source. Selected from “DI Alarm”, “SMS Control”, “Call Control”, selections can be one or more. DI Alarm: Digital Output triggers the related action when there is alarm from Digital Input. SMS Control: Digital Output triggers the related action when receiving SMS from the number in the phone book. Call Control: Digital Output triggers the related action when receiving phone call	Null

	from the number in the phone book.	
Alarm On Action	Digital Output initiates when there is an alarm. Selected from "OFF", "ON", "Pulse". OFF: Open from GND when triggered. ON: Short contact with GND when triggered. Pulse: Generates a square wave as specified in the pulse mode parameters when triggered.	ON
Alarm Off Action	Digital Output initiates when alarm recovered. Selected from "OFF", "ON", "Pulse". OFF: Open from GND when triggered. ON: Short contact with GND when triggered. Pulse: Generates a square wave as specified in the pulse mode parameters when triggered.	ON
Status When Power On	Specify the Digital Output status when power on. Selected from "OFF", "ON". OFF: Open from GND. ON: Short contact with GND.	ON
Keep On (s)	Available when digital output Alarm On Action/Alarm Off Action status is ON, input the Digital Output keep on status time. Input from 0 to 255 seconds. (0=keep on until the next action)	0
Delay	Available when enable Pulse in Alarm On Action/Alarm Off Action. The first pulse will be generated after a "Delay". Input from 0 to 30000ms. (0=generate pulse without delay)	0
Low	Available when enable Pulse in Alarm On Action/Alarm Off Action. In Pulse Output mode, the selected digital output channel will generate a square wave as specified in the pulse mode parameters. The low level widths are specified here. Input from 1 to 30000 ms.	10
High	Available when enable Pulse in Alarm On Action/Alarm Off Action. In Pulse Output mode, the selected digital output channel will generate a square wave as specified in the pulse mode parameters. The high level widths are specified here. Input from 1 to 30000 ms.	10
Output	Available when enable Pulse in Alarm On Action/Alarm Off Action. The number of pulses, input from 0 to 30000. (0 for continuous pulse output)	0
SMS Content On	Available when enable SMS Control in Alarm Source. Input the SMS content to enable "Alarm On Action" by SMS (70 ASCII char max).	Null
SMS Content Off	Available when enable SMS Control in Alarm Source. Input the SMS content to enable "Alarm Off Action" by SMS. (70 ASCII char max)	Null
SMS Content On Reply	Input the SMS content, which will be sent after DO was triggered. (70 ASCII char max).	Null

SMS Content Off Reply	Input the SMS content, which will be sent after DO was recovered. (70 ASCII char max).	Null
Phone Group	Click to add phone groups.	Null

Note: R3000-4L does not support SMS/Call function, so Call and SMS section will not be displayed on the web page.

3.16 Configuration -> USB

This section allows users to set the USB parameters.

Note: Users can insert a USB storage device, such as U disk and hard disk, into the router's USB interface. If there is configuration file or firmware of R3000 inside the USB storage devices, R3000 will automatically update the configuration file or firmware. We will provide another file to show how to do USB automatic update.

USB

USB Configuration

Enable automatic update of configuration

Enable automatic update of firmware

USB		
Item	Description	Default
Enable automatic update of configuration	Click Enable to automatically update the configuration file of R3000 when insert the USB storage devices which has R3000's configuration file.	Disable
Enable automatic update of firmware	Click Enable to automatically update the firmware of R3000 when insert the USB storage devices which has R3000's firmware.	Disable

3.17 Configuration -> GPS

This section allows users to set the GPS setting parameters.

GPS Setting **GPS Status** **Map**

Enable GPS

Enable GPS

GPS Basic Setting

Report To RS232

RS232 Report Type:

RS232 Report Interval(s):

GNSS Type:

GPS Server Setting

<input type="text" value="Index"/>	<input type="text" value="Server Name"/>
<input type="button" value="Add"/>	

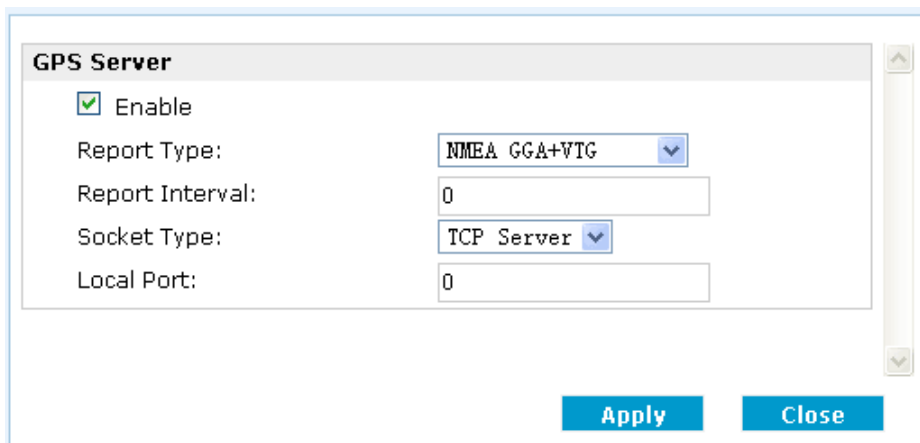

GPS Setting @ GPS		
Item	Description	Default
Enable GPS	Click to enable GPS function.	Disable
Report To RS232	Click to enable GPS report to RS232 serial port of router.	Disable
RS232 Report Type	Select from "NMEA GGA+VTG", "NMEA GGA+VTG+RMC" and "NMEA RMC". NMEA GGA+VTG: Global Positioning System Fix Data (GGA) + Track Made Good and Ground Speed (VTG) . NMEA GGA+VTG+RMC: Global Positioning System Fix Data (GGA) + Track Made Good and Ground Speed (VTG) + Recommended Minimum Specific GPS/TRANSIT Data (RMC) . NMEA RMC: Recommended Minimum Specific GPS/TRANSIT Data (RMC).	NMEA GGA+VTG
RS232 Report Interval	Set the interval to report GPS status to RS232 serial port of router.	1
GNSS Type	Global Navigation Satellite System Type: GPS: Global Position System.	GPS
Index @ GPS Server Setting	Show the index of GPS Server.	Null
Server Name @ GPS Server Setting	Show the type of GPS Server.	Null
Add	Click "Add" to add GPS Server.	
Report Type	Select from "NMEA GGA+VTG", "NMEA GGA+VTG+RMC" and "NMEA RMC". NMEA GGA+VTG: Global Positioning System Fix Data (GGA) + Track Made Good and Ground Speed (VTG) . NMEA GGA+VTG+RMC: Global Positioning System Fix Data (GGA) + Track Made Good and Ground Speed (VTG) + Recommended Minimum Specific GPS/TRANSIT Data (RMC) . NMEA RMC: Recommended Minimum Specific GPS/TRANSIT Data (RMC).	NMEA GGA+VTG
Report Interval	Set the interval to report GPS status to GPS Server.	0
Socket Type	Select from "TCP Server", "TCP Client" and "UDP". TCP Client: Router works as TCP client, initiate TCP connection to TCP	TCP Server

	server (GPS Server), the server address supports both IP and domain name. TCP Server: Router works as TCP server (GPS Server), listening for connection request from TCP client. UDP: Router works as UDP client.	
Local Port @ TCP Server	Set the local port number of TCP server.	0
Server Address @ TCP Client	Set the Server address of TCP server.	Null
Server Port @ TCP Client	Set the remote Port number of TCP server. Note: router supports up to 3 GPS servers, supports re-connect when the TCP connection is down.	0

This section allows users to check the GPS status.

GPS Setting
GPS Status
Map

GPS Status	
GPS Status:	No Fix/Invalid
Last Fixed Time:	
Last Failed Time:	
Satellites In Use:	0
Satellites In View:	1
UTC:	2000-00-00 00:00:00
Latitude:	0.000000
Longitude:	0.000000
Altitude:	0.000000
Speed:	0.000000KMH

GPS Status @ GPS		
Item	Description	Default
GPS Status	Show the GPS Status. GPS status includes: Not Installed, Disabled, No Fix/Invalid, Standalone GPS Fix, Differential GPS Fix. Not Installed: No GPS module inside. Disabled: GPS function is not enabled (not click "Enable GPS" in item "GPS Setting" yet). No Fix/Invalid: GPS function is enabled, but do not get GPS signal (User should put router outdoor to get stronger GPS signal). Standalone GPS Fix: Standalone GPS techniques is a mature, universal GPS positioning mode, only get position from satellite. Differential GPS Fix: Differential GPS techniques are used to enhance the quality of location data. It can be applied in real-time directly in the field or when post processing data in the office.	Not Installed

Last Fixed Time	Show the time that router located successfully at last time.	Null
Last Failed Time	Show the time that router located unsuccessfully at last time.	Null
Satellites In Use	Show how many satellites are in use.	0
Satellites In View	Show how many satellites are in view.	0
UTC	Show the UTC of satellites, which is world unified time, not local time.	Null
Latitude	Show the latitude status of router.	0.0
Longitude	Show the Longitude status of router.	0.0
Altitude	Show the Altitude status of router.	0.0
Speed	Show the movement speed of router.	0.0KMH

This section allows users to check the real time GPS status of router in the map.

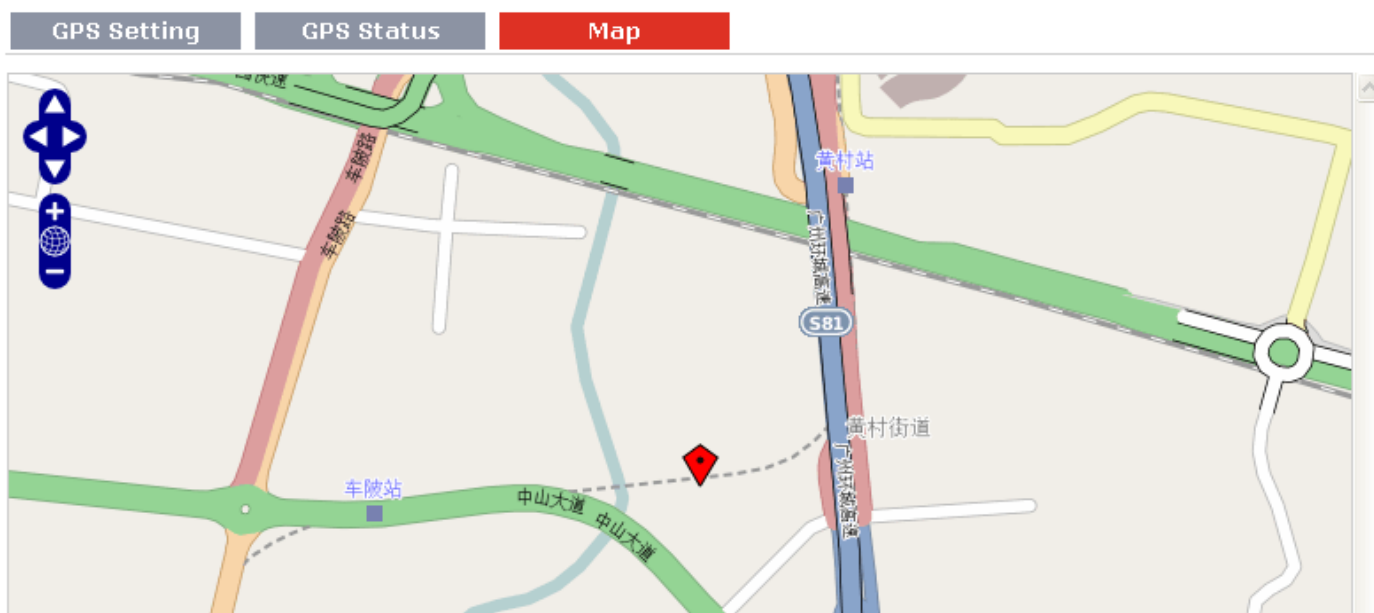

3.18 Configuration -> NAT/DMZ

This section allows users to set the NAT/DMZ parameters.

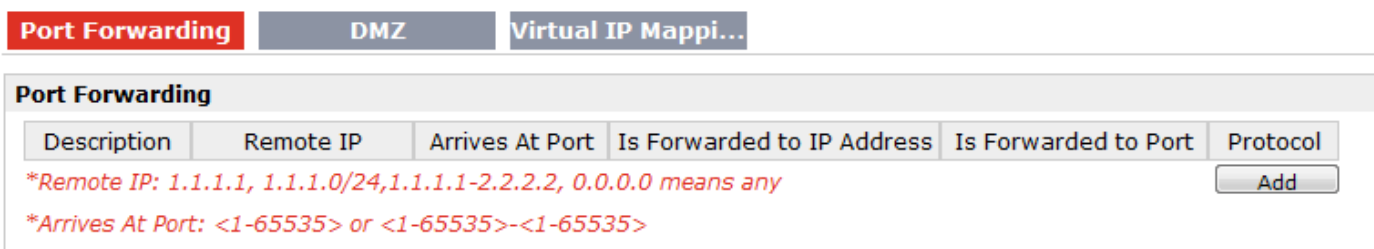

Port Forwarding @ NAT/DMZ		
Item	Description	Default
Port Forwarding	Manually defining a rule in the router to send all data received on some range of ports on the internet side to a port and IP address on the LAN side.	Null
Remote IP	Set the remote IP address.	Null
Arrives At Port	The port of the internet side which you want to forward to LAN side.	Null
Is Forwarded to IP Address	The device's IP on the LAN side which you want to forward the data to.	Null
Is Forwarded to Port	The device's port on the LAN side which you want to forward the data to.	Null
Protocol	Select from "TCP", "UDP" or "TCP&UDP" which depends on the application.	TCP

Port Forwarding **DMZ** Virtual IP Mappi...

Enable DMZ

Enable DMZ

DMZ Settings

DMZ Host:

Source Address:

**1.1.1.1", "1.1.1.0/24", "1.1.1.1-2.2.2.2", "0.0.0.0" means any*

DMZ @ NAT/DMZ		
Item	Description	Default
DMZ	DMZ host is a host on the internal network that has all ports exposed, except those ports otherwise forwarded.	Null
Enable DMZ	Select to enable the DMZ function.	Enable
DMZ Host	Enter the IP address of the DMZ host which on the internal network.	0.0.0.0
Source Address	Set the address which can talk to the DMZ host. Null means for any addresses.	0.0.0.0

Port Forwarding **DMZ** Virtual IP Mappi...

Virtual IP Mapping Setting

Virtual IP for Router:

Internal PC's IP Mapping List

Description

Virtual IP

Real IP

Add

Virtual IP Mapping@ NAT/DMZ		
Item	Description	Default
Virtual IP for Router	Set a Virtual IP for router.	Null
Virtual IP @ Internal PC's IP Mapping List	Set a Virtual IP for the Internal PC.	Null
Real IP @ Internal PC's IP Mapping List	The Internal PC's Real IP, which is mapping the PC's Virtual IP one-to-one.	Null

3.19 Configuration -> Firewall

This section allows users to set the firewall parameters.

Basic
Filtering
MAC-Binding

Filter Basic Settings

- Remote Access Using HTTP
- Remote Access Using TELNET
- Remote Access Using SNMP
- Remote Access Using SSH2
- Remote Ping Request
- Enable DNS Masquerade
- Enable Console CLI
- Defend DoS Attack

If you disable one of tabs: “Remote Access Using HTTP”, “Remote Access Using TELNET”, “Remote Access Using SNMP”, “Remote Access Using SSH2” or “Remote Ping Request”, it will pop up “Add Allow Access List” to allow you to preset specific user to access to WAN interface of R3000. For example, if you disable “Remote Ping Request” and add “Remote IP” then only these specific users can ping to WAN interface of R3000.

Basic
Filtering
MAC-Binding

Filter Basic Settings

- Remote Access Using HTTP
- Remote Access Using TELNET
- Remote Access Using SNMP
- Remote Access Using SSH2
- Remote Ping Request
- Enable DNS Masquerade
- Enable Console CLI
- Defend DoS Attack

Add Allow Access List

Description	Remote IP
<i>*IP: 1.1.1.1, 1.1.1.0/24, 1.1.1.1-2.2.2.2</i>	
<input type="button" value="Add"/>	

Basic @ Firewall		
Item	Description	Default
Remote Access Using HTTP	Enable to allow users to access the router remotely on the internet side via HTTP.	Enable
Remote Access Using TELNET	Enable to allow users to access the router remotely on the internet side via Telnet.	Enable
Remote Access Using SNMP	Enable to allow users to access the router remotely on the internet side via SNMP.	Enable

Remote Access Using SSH2	Enable to allow users to access the router remotely on the internet side via SSH2.	Enable
Remote Ping Request	Enable to make router reply the Ping requests from the internet side.	Enable
Enable DNS Masquerade	Open the 53 port of the router, enable users to use the DNS function of the router.	Enable
Enable Console CLI	Enable to configurate router through Command Line Interface.	Enable
Defend Dos Attack	Enable to defend dos attack. Dos attack is an attempt to make a machine or network resource unavailable to its intended users.	Enable

Basic **Filtering** **MAC-Binding**

Default Filter Policy

Accept Drop

Add Filter List

Action	Description	Source IP	Source Port	Target IP Address	Target Port	Protocol
<i>*IP: 1.1.1.1, 1.1.1.0/24,1.1.1.1-2.2.2.2, 0.0.0.0 means any</i> <i>*Port: <1-65535> or <1-65535>-<1-65535></i>						
						<input type="button" value="Add"/>

Blocking By URL Address

Description	URL
<input type="button" value="Add"/>	

Blocking By Keyword

Description	Keyword
<input type="button" value="Add"/>	

Filtering @ Firewall		
Item	Description	Default
Default Filter Policy	Select from "Accept" and "Drop". Accept: Router will accept all the connecting requests except the hosts which fit the filter list. Drop: Router will only reject the connecting requests from the hosts which fit the filter list.	Accept
Add Filter List	Click "Add" to add a filter list.	Null
Action @Add Filter List	Select from "Accept" and "Drop". Accept: Router will reject all the connecting requests except the hosts which fit this filter rule. Drop: Router will only accept the connecting requests from the hosts which fit this filter rule.	Accept
Source IP @ Add Filter List	Defines if access is allowed from one or a range of IP addresses which are defined by Source IP Address, or every IP addresses.	Null
Source Port@ Add Filter List	Defines if access is allowed from one or a range of port which is defined by Source Port.	Null
Target IP Address @	Defines if access is allowed to one or a range of IP addresses which are defined	Null

Add Filter List	by Target IP Address, or every IP addresses.	
Target Port @ Add Filter List	Defines if access is allowed to one or a range of port which is defined by Target Port.	Null
Protocol @ Add Filter List	Select from "TCP", "UDP", "TCP&UDP", "ICMP" or "ALL". If you don't know what kinds of protocol of your application, we recommend you select "ALL".	TCP
Blocking By URL Address	Click "Add" to add a URL list.	Null
URL@ Blocking By URL Address	Block the access according to the URL address that filled in the blank.	Null
Blocking By Keywork	Click "Add" to add a Keywork list.	Null
Keywork@ Blocking By Keywork	Block the access according to the Keywork that filled in the blank.	Null

Note: You can use "-" to define a range of IP addresses or ports, e.g. 1.1.1.1-2.2.2.2, 10000-12000. The priority of **Filter List** is higher than **Default Filter Policy**. Firewall policy would not take effect on the packet receive to R3000 itself, but only take effect on packet "pass through" the R3000.

Basic
Filtering
MAC-Binding

MAC-IP Binding List

Description	MAC Address	IP Address
*MAC: ff:ff:ff:ff:ff:ff		

Mac-Binding @ Firewall		
Item	Description	Default
Mac-IP Bounding	The defined host (MAC) on the LAN side only can use the defined IP address to communicate with router, or will be rejected.	Null
Mac Address	Enter the defined host's Mac Address.	Null
IP Address	Enter the defined host's IP Address.	Null

3.20 Configuration -> QoS

This section allows users to set the QoS parameters.

QoS

Enable Quality Of Service(QoS)

Enable QoS

Quality of Service(QoS) Basic Setting

Downlink Speed (kbps):

Uplink Speed (kbps):

Optimize for TCP Flags: SYN ACK FIN RST

Optimize for ICMP:

Optimize for Serial Data Forwarding:

Priority Percent Definition:

Exempt:

Premium:

Express:

Normal:

Bulk:

Default Priority:

QoS Ethernet Port Based Control

Enable Port Based Priority

Eth0 Priority:

Eth1 Priority:

QoS Service Control List

Service Name	Protocol	Port	Priority
<input type="button" value="Add"/>			

QoS MAC Control List

MAC Address	Priority
*MAC: ff:ff:ff:ff:ff:ff	<input type="button" value="Add"/>

QoS IP Control List

IP Address	Priority
<input type="button" value="Add"/>	

QoS		
Item	Description	Default
Enable QoS	Click to enable "QoS" function.	Disable
Downlink Speed (kbps)	Prescribe downlink speed of router. Note: Default setting "0" means that there is no limitation of downlink speed.	0
uplink Speed (kbps)	Prescribe uplink speed of router. Note: Default setting "0" means that there is no limitation of uplink speed.	0
Optimize for TCP Flags	User can choose to enable TCP flags: "SYN", "ACK", "FIN", "RST", which means data with above TCP Flags will get the highest priority to occupy bandwidth. After enabled, router will enhance respond timeout of TCP control, in case that data resend frequently.	Disable
Optimize for ICMP	Enable to optimize for ICMP, which means ICMP will get the highest priority to occupy bandwidth. After enabled respond interval of PING control will be shorter. Note: if user click to enable "Optimize for TCP Flags", "Optimize for Serial Data Forwarding", and "Optimize for ICMP" at the same time (these three services are in the same priority level), router will automatically start Stochastic Fairness Queueing (SFQ) strategy to make a fair bandwidth allocation, in case of one service occupy all the bandwidth.	Disable
Optimize for Serial Data Forwarding	Enable to optimize for serial data forwarding, which means serial data forwarding will get the highest priority to occupy bandwidth. When enable serial data forwarding it need to enable local port number for controlling. Therefore, it needs to set local port number of router even if router is as TCP Client.	Disable
Priority Percent Definition	Define priority percent of "Exempt", "Premium", "Express", "Normal" and "Bulk". "Exempt" is defaulted as 50; "Premium" is defaulted as 25; "Express" is defaulted as 15; "Normal" is defaulted as 10; "Bulk" is 1.	
Default Priority	Select from "Exempt", "Premium", "Express", "Normal" and "Bulk". Users (Services) with no other pre-priority set will use this default priority. Exempt: this is the highest priority which guarantees that the minimum global rate of router is 50% of "Downlink Speed", and the maximum rate can reach to 100% of "Downlink Speed". Premium: guarantees that the minimum global rate of router is 25% of "Downlink Speed", and the maximum rate can reach to 100% of "Downlink Speed". Express: guarantees that the minimum global rate of router is 15% of "Downlink Speed", and the maximum rate can reach to 100% of "Downlink Speed". Normal: guarantees that the minimum global rate of router is 10% of "Downlink Speed", and the maximum rate can reach to 100% of "Downlink Speed". Bulk: guarantees that the minimum global rate of router is 1% of "Downlink Speed", and the maximum rate can reach to 100% of "Downlink Speed".	Normal
Enable Port Based Priority @ Qos Port Base Control	Click to enable Ethernet port base priority control.	Disable

Eth0 Priority @ QoS Port Base Control	Define QoS of Eth0 interface. Different slave device that connect to R3000's Eth0 interface will be assigned specific QoS.	Exempt
Eth1 Priority @ QoS Port Base Control	Define QoS of Eth1 interface. Different slave device that connect to R3000's Eth1 interface will be assigned specific QoS.	Exempt
MAC Address @ QoS MAC Control List	Enter MAC address of the user (for example, PC) who you want to set it with QoS Control. Router supports up to 20 users set with QoS MAC Control. Priority of QoS MAC Control is higher than that of QoS IP control.	Null
Priority @ QoS MAC Control List	<p>Select from "Exempt", "Premium", "Express", "Normal" and "Bulk".</p> <p>Select the priority of the user (for example, PC) who you want to set it with QoS Control.</p> <p>Exempt: this is the highest priority which guarantees that the minimum global rate of router is 50% of "Downlink Speed", and the maximum rate can reach to 100% of "Downlink Speed".</p> <p>Premium: guarantees that the minimum global rate of router is 25% of "Downlink Speed", and the maximum rate can reach to 100% of "Downlink Speed".</p> <p>Express: guarantees that the minimum global rate of router is 15% of "Downlink Speed", and the maximum rate can reach to 100% of "Downlink Speed".</p> <p>Normal: guarantees that the minimum global rate of router is 10% of "Downlink Speed", and the maximum rate can reach to 100% of "Downlink Speed".</p> <p>Bulk: guarantees that the minimum global rate of router is 1% of "Downlink Speed", and the maximum rate can reach to 100% of "Downlink Speed".</p>	Exempt
IP Address @ QoS IP Control List	Enter IP address of the user (for example, PC) who you want to set it with QoS Control. Router supports up to 20 users set with QoS IP Control. If want to control one network segment, user can set "IP Address" as format "x.x.x.x/24" or "x.x.x.x/255.255.255.0". For example, if we to control network segment "172.16.x.x", we can set "172.16.0.0/16" or "172.16.0.0/255.255.0.0" in "IP Address".	Null
Priority @ QoS IP Control List	<p>Select from "Exempt", "Premium", "Express", "Normal" and "Bulk".</p> <p>Select the priority of the user (for example, PC) who you want to set it with QoS Control.</p> <p>Exempt: this is the highest priority which guarantees that the minimum global rate of router is 50% of "Downlink Speed", and the maximum rate can reach to 100% of "Downlink Speed".</p> <p>Premium: guarantees that the minimum global rate of router is 25% of "Downlink Speed", and the maximum rate can reach to 100% of "Downlink Speed".</p> <p>Express: guarantees that the minimum global rate of router is 15% of "Downlink Speed", and the maximum rate can reach to 100% of "Downlink Speed".</p> <p>Normal: guarantees that the minimum global rate of router is 10% of "Downlink Speed", and the maximum rate can reach to 100% of "Downlink Speed".</p> <p>Bulk: guarantees that the minimum global rate of router is 1% of "Downlink Speed", and the maximum rate can reach to 100% of "Downlink Speed".</p>	Exempt
Service Name @ QoS Service Control List	Set server name of the service that you want to set it with QoS Control. Router supports up to 20 users set with QoS Service Control. Priority of QoS Service Control is higher than that of both QoS IP control and QoS MAC control.	Null

Protocol @ QoS Service Control List	Select from "TCP", "UDP" and "TCP&UDP".	TCP
Port @ Service Control List	Enter the port number of the service that you want to set it with QoS Control.	Null
Priority @ QoS Service Control List	Select from "Exempt", "Premium", "Express", "Normal" and "Bulk". Select the priority of the service that you want to set it with QoS Control. Exempt: this is the highest priority which guarantees that the minimum global rate of router is 50% of "Downlink Speed", and the maximum rate can reach to 100% of "Downlink Speed". Premium: guarantees that the minimum global rate of router is 25% of "Downlink Speed", and the maximum rate can reach to 100% of "Downlink Speed". Express: guarantees that the minimum global rate of router is 15% of "Downlink Speed", and the maximum rate can reach to 100% of "Downlink Speed". Normal: guarantees that the minimum global rate of router is 10% of "Downlink Speed", and the maximum rate can reach to 100% of "Downlink Speed". Bulk: guarantees that the minimum global rate of router is 1% of "Downlink Speed", and the maximum rate can reach to 100% of "Downlink Speed".	Exempt
Note: If services are in the same priority level, router will automatically start Stochastic Fairness Queueing (SFQ) strategy to make a fair bandwidth allocation.		

3.21 Configuration -> IP Routing

This section allows users to set the IP routing parameters.

Static Route
RIP
OSPF

Static Route Table

Interface	Destination	NetMask	Gateway
<input type="button" value="Add"/>			

Static Route @ IP Routing		
Item	Description	Default
Static Route Table	Allow users to add, delete or modify static route rules manually.	Null
Interface	Select from "WAN", "LAN_0" or "LAN_1".	WAN
Destination	Enter the destination host's IP address or destination network.	Null
Netmask	Enter the Netmask of the destination or destination network.	Null
Gateway	Enter the gateway's IP address of this static route rule. Router will forward all the data which fit for the destination and Netmask to this gateway.	Null

Static Route	RIP	OSPF
RIPIPv4 Enabled		
<input checked="" type="checkbox"/> Enable RIP Protocol Setting		
RIP Protocol Version		
<input checked="" type="radio"/> RIPv1 <input type="radio"/> RIPv2		
RIP Protocol common Settings		
Neighbor IP:	<input type="text"/>	
Update time(s):	<input type="text" value="30"/>	
Timeout(s):	<input type="text" value="180"/>	
Garbage(s):	<input type="text" value="120"/>	
RIP protocol Advance Setting		
<input type="checkbox"/> Enable Advance		
Network List		
<input type="text" value="Network Address"/>	<input type="text" value="NetMask"/>	<input type="button" value="Add"/>

RIP @ IP Routing		
Item	Description	Default
RIP	RIP (Routing Information Protocol) is a distance-vector routing protocol, which employs the hop count as a routing metric. RIP prevents routing loops by implementing a limit on the number of hops allowed in a path from the source to a destination.	Null
Enable RIP Protocol Setting	Tick to enable RIP function.	Disable
RIP Protocol Version	Select from "RIPv1" and "RIPv2".	RIPv1
Neighbor IP	If you input this neighbor IP, router will only send RIP request message to this IP instead of broadcast. This item only needs to be set in some unicast network.	0.0.0.0
Update times	Defines the interval between routing updates.	30
Timeout	Defines the route aging time. If no update for a route is received after the aging time elapses, the metric of the route is set to 16 in the routing table.	180
Garbage	Defines the interval from when the metric of a route becomes 16 to when it is deleted from the routing table. During the Garbage-Collect timer length, RIP advertises the route with the routing metric set to 16. If no update is announced for that route after the Garbage-Collect timer expires, the route will be deleted from the routing table.	120
Enable Advance	Tick to enable RIP protocol Advance Setting.	Disable
Default Metric	This value is used for redistributed routes.	1
Distance	The first criterion that a router uses to determine which routing protocol to use if two protocols provide route information for the same destination.	120

Passive	Select from "None", "Eth0", "Eth1" and "Default". This command sets the specified interface to passive mode. On passive mode interface, all receiving packets are processed as normal and Rip info does not send either multicast or unicast RIP packets except to RIP neighbors specified with neighbor command. The default is to be passive on all interfaces.	None
Enable Default Origination	Enable to make router send the default route to the other routers which in the same IGP AS.	Disable
Enable Redistribute Connect	Redistribute connected routes into the RIP tables.	Disable
Enable Redistribute Static	Redistributes routing information from static route entries into the RIP tables.	Disable
Enable Redistribute OSPF	Redistributes routing information from OSPF route entries into the RIP tables.	Disable
Network List	Router will only report the RIP information in this list to its neighbor.	Null
Network Address	Enter the Network address which Eth0 or Eth 1 connects directly.	Null
Netmask	Enter the Network's Netmask which Eth0 or Eth 1 connects directly.	Null

- Static Route
- RIP
- OSPF

OSPF Protocol

Enable OSPFv2

OSPF @ IP Routing		
Item	Description	Default
OSPF	OSPF (Open Shortest Path First) is a link-state routing protocol for IP networks. It uses a link state routing algorithm and falls into the group of interior routing protocols, operating within a single autonomous system (AS).	Null
Enable OSPFv2	Tick to enable OSPF function.	Disable

3.22 Configuration -> DynDNS

This section allows users to set the DynDNS parameters.

DynDNS

DynDNS Settings

Enable DynDNS

Service Type: DynDNS-Dynamic ▾

Hostname:

Username:

Password:

DynDNS Status: *DynDNS is initializing.....*

DynDNS		
Item	Description	Default
DynDNS	The Dynamic DNS function allows you to alias a dynamic IP address to a static domain name, allowing users whose ISP does not assign them a static IP address to use a domain name. This is especially useful for hosting servers via your connection, so that anyone wishing to connect to you may use your domain name, rather than having to use your dynamic IP address, which changes from time to time. This dynamic IP address is the WAN IP address of the router, which is assigned to you by your ISP.	Null
Enable DynDNS	Tick to enable DynDNS function.	Disable
Service Type	Select the DDNS service from “DynDNS-Dynamic”, “QDNS (3322)”, “NOIP” which you have established an account with. “Custom” could be used for linking custom DDNS server.	DynDNS-Dynamic
hoastmen	Enter the Host name the DDNS server provided.	Null
Username	Enter the user name the DDNS server provided.	Null
Password	Enter the password the DDNS server provided.	Null
URL	Enter the connection address of custom DDNS server.	Null
Force Update	Click to the update and use the DynDNS settings.	Null
DynDNS Status	Show current status of DynDNS	Null

3.23 Configuration -> IPsec

This section allows users to set the IPsec parameters.

IPsec Basic
IPsec Tunnel
X.509

IPsec Basic

Enable NAT Traversal

Keepalive Interval(s):

IPsec Basic @ IPsec		
Item	Description	Default
Enable NAT Traversal	Tick to enable NAT Traversal for IPsec. This item must be enabled when router under NAT environment.	Enable
Keepalive Interval	The interval that router sends keepalive packets to NAT box so that to avoid it to remove the NAT mapping.	30

IPsec Basic
IPsec Tunnel
X.509

IPsec Tunnel

Tunnel name	Description

IPsec Common

IPsec Gateway Address:

IPsec Mode:

IPsec Protocol:

Local Subnet:

Local Subnet Mask:

Local ID Type:

Remote Subnet:

Remote Subnet Mask:

Remote ID Type:

IKE Parameter

Negotiation Mode:

Encryption Algorithm:

Authentication Algorithm:

DH Group:

Authentication:

Secrets:

Life Time(s):

SA Parameter

SA Algorithm:

PFS Group:

Life Time(s):

DPD Time Interval (s):

DPD Timeout (s):

IPsec Advanced

Enable Compress

Enable ICMP Detection

ICMP Detection Server:

ICMP Detection Local IP:

ICMP Detection Interval (s):

ICMP Detection Timeout (s):

ICMP Detection Retries:

IPSec Tunnel @ IPSec		
Item	Description	Default
Add	Click Add to add new IPSec Tunnel	Null
Enable	Enable IPSec Tunnel, the max tunnel account is 3	Null
IPSec Gateway Address	Enter the address of remote side IPSec VPN server.	Null
IPSec Mode	Select from "Tunnel" and "Transport". Tunnel: Commonly used between gateways, or at an end-station to a gateway, the gateway acting as a proxy for the hosts behind it. Transport: Used between end-stations or between an end-station and a gateway, if the gateway is being treated as a host—for example, an encrypted Telnet session from a workstation to a router, in which the router is the actual destination.	Tunnel
IPSec Protocol	Select the security protocols from "ESP" and "AH". ESP: Uses the ESP protocol. AH: Uses the AH protocol.	ESP
Local Subnet	Enter IPSec Local Protected subnet's address.	0.0.0.0
Local Subnet Mask	Enter IPSec Local Protected subnet's mask.	0.0.0.0
Local ID Type	Select from "IP Address", "FQDN" and "User FQDN" for IKE negotiation. "Default" stands for "IP Address". IP Address: Uses an IP address as the ID in IKE negotiation. FQDN: Uses an FQDN type as the ID in IKE negotiation. If this option is selected, type a name without any at sign (@) for the local security gateway, e.g., test.robustel.com. User FQDN: Uses a user FQDN type as the ID in IKE negotiation. If this	Default

	option is selected, type a name string with an sign "@" for the local security gateway, e.g., test@robustel.com.	
Remote Subnet	Enter IPsec Remote Protected subnet's address.	0.0.0.0
Remote Subnet Mask	Enter IPsec Remote Protected subnet's mask.	0.0.0.0
Remote ID Type	Select from "IP Address", "FQDN" and "User FQDN" for IKE negotiation. IP Address: Uses an IP address as the ID in IKE negotiation. FQDN: Uses an FQDN type as the ID in IKE negotiation. If this option is selected, type a name without any at sign (@) for the local security gateway, e.g., test.robustel.com. User FQDN: Uses a user FQDN type as the ID in IKE negotiation. If this option is selected, type a name string with a sign "@" for the local security gateway, e.g., test@robustel.com.	Default
Negotiation Mode	Select from "Main" and "aggressive" for the IKE negotiation mode in phase 1. If the IP address of one end of an IPsec tunnel is obtained dynamically, the IKE negotiation mode must be aggressive. In this case, SAs can be established as long as the username and password are correct.	Main
Encryption Algorithm	Select from "DES", "3DES", "AES128", "AES192" and "AES256" to be used in IKE negotiation. DES: Uses the DES algorithm in CBC mode and 56-bit key. 3DES: Uses the 3DES algorithm in CBC mode and 168-bit key. AES128: Uses the AES algorithm in CBC mode and 128-bit key. AES192: Uses the AES algorithm in CBC mode and 192-bit key. AES256: Uses the AES algorithm in CBC mode and 256-bit key.	3DES
Authentication Algorithm	Select from "MD5" and "SHA1" to be used in IKE negotiation. MD5: Uses HMAC-SHA1. SHA1: Uses HMAC-MD5.	MD5
DH Group	Select from "MODP768_1", "MODP1024_2" and "MODP1536_5" to be used in key negotiation phase 1. MODP768_1: Uses the 768-bit Diffie-Hellman group. MODP1024_2: Uses the 1024-bit Diffie-Hellman group. MODP1536_5: Uses the 1536-bit Diffie-Hellman group.	MODP1024_2
Authentication	Select from "PSK", "CA", "XAUTH Init PSK" and "XAUTH Init CA" to be used in IKE negotiation. PSK: Pre-shared Key. CA: Certification Authority. XAUTH: Extended Authentication to AAA server.	PSK
Secrets	Enter the Pre-shared Key.	Null
Life Time @ IKE Parameter	Set the lifetime in IKE negotiation. Before an SA expires, IKE negotiates a new SA. As soon as the new SA is set up, it takes effect immediately and the old one will be cleared automatically when it expires.	86400

SA Algorithm	Select from “DES_MD5_96”, “DES_SHA1_96”, “3DES_MD5_96”, “3DES_SHA1_96”, “AES128_MD5_96”, “AES128_SHA1_96”, “AES192_MD5_96”, “AES192_SHA1_96”, “AES256_MD5_96” and “AES256_SHA1_96” when you select “ESP” in “Protocol”; Select from “AH_MD5_96” and “AH_SHA1_96” when you select “AH” in “Protocol”; Note: Higher security means more complex implementation and lower speed. DES is enough to meet general requirements. Use 3DES when high confidentiality and security are required.	3DES_MD5_96
PFS Group	Select from “PFS_NULL”, “MODP768_1”, “MODP1024_2” and “MODP1536_5”. PFS_NULL: Disable PFS Group MODP768_1: Uses the 768-bit Diffie-Hellman group. MODP1024_2: Uses the 1024-bit Diffie-Hellman group. MODP1536_5: Uses the 1536-bit Diffie-Hellman group.	PFS_NULL
Life Time @ SA Parameter	Set the IPsec SA lifetime. Note: When negotiating to set up IPsec SAs, IKE uses the smaller one between the lifetime set locally and the lifetime proposed by the peer.	3600
DPD Time Interval	Set the interval after which DPD is triggered if no IPsec protected packets is received from the peer. DPD: Dead peer detection. DPD irregularly detects dead IKE peers. When the local end sends an IPsec packet, DPD checks the time the last IPsec packet was received from the peer. If the time exceeds the DPD interval, it sends a DPD hello to the peer. If the local end receives no DPD acknowledgment within the DPD packet retransmission interval, it retransmits the DPD hello. If the local end still receives no DPD acknowledgment after having made the maximum number of retransmission attempts, it considers the peer already dead, and clears the IKE SA and the IPsec SAs based on the IKE SA.	60
DPD Timeout	Set the timeout of DPD packets.	180
Enable Compress	Tick to enable compressing the inner headers of IP packets.	Disable
Enable ICMP Detection	Click to enable ICMP detection.	Disable
ICMP Detection Server	Enter the IP address or domain name or remote server. Router will ping this address/domain name to check that if the current connectivity is active.	Null
ICMP Detection Local IP	Set the local IP address.	Null
ICMP Detection Interval	Set the ping interval time.	30
ICMP Detection Timeout	Set the ping timeout.	5
ICMP Detection Retries	If Router ping the preset address/domain name time out continuously for Max Retries time, it will try to re-establish the VPN tunnel.	3

Authentication Manage

Select Cert Type:

Authentication Status

Cert Type	Ca.crt	Remote.crt	Local.crt	Private.key	Crl.pem
Tunnel_1					
Tunnel_2					
Tunnel_3					

X.509 @ IPsec		
Item	Description	Default
Select Cert Type	Select the IPsec tunnel which the certification used for.	Null
CA	Click "Browse" to select the correct CA file from your PC, and then click "Import" to import it to the router. Click "Export" you can export the CA file from router to your PC.	Null
Remote Public Key	Click "Browse" to select the correct Remote Public Key file from your PC, and then click "Import" to import it to the router. Click "Export" you can export the Remote Public Key file from router to your PC.	Null
Local Public Key	Click "Browse" to select the correct Local Public Key file from your PC, and then click "Import" to import it to the router. Click "Export" you can export the Local Public Key file from router to your PC.	Null
Local Private Key	Click "Browse" to select the correct Local Private Key file from your PC, and then click "Import" to import it to the router. Click "Export" you can export the Local Private Key file from router to your PC.	Null
CRL	Click "Browse" to select the correct CRL file from your PC, and then click "Import" to import it to the router. Click "Export" you can export the CRL file from router to your PC.	Null
Authentication Status	Show current status parameters of IPsec.	Null

3.24 Configuration -> Open VPN

This section allows users to set the Open VPN parameters.

Client
Server
X.509

Client

Tunnel name	Description
-------------	-------------

Add

Enable OpenVPN Client

Enable

Protocol: UDP

Remote IP Address:

Port: 1194

Interface: tun

Authentication: None

Local IP: 10.8.0.2

Remote IP: 10.8.0.1

Enable NAT

Ping Interval: 20

Ping-Restart: 120

Compression: LZO

Encryption: BF-CBC

MTU: 1500

Max Frame Size: 1500

Verbose Level: ERR

Expert Options:

*--xx xx,parameter,eg:--config xx.config

Local Route

Subnet	Subnet Mask
--------	-------------

Add

Client @ Open VPN		
Item	Description	Default
Enable	Enable OpenVPN Client, the max tunnel account is 3	Null
Protocol	Select from "UDP" and "TCP Client" which depends on the application.	UDP
Remote IP Address	Enter the remote IP address or domain name of remote side OpenVPN server.	Null
Port	Enter the listening port of remote side OpenVPN server.	1194

Interface	Select from “tun” and “tap” which are two different kinds of device interface for OpenVPN. The difference between tun and tap device is this: a tun device is a virtual IP point-to-point device and a tap device is a virtual Ethernet device.	tun
Authentication	Select from four different kinds of authentication ways: “Pre-shared”, “Username/Password”, “X.509 cert” and “X.509 cert+user”.	None
Local IP	Define the local IP address of OpenVPN tunnel.	10.8.0.2
Remote IP	Define the remote IP address of OpenVPN tunnel.	10.8.0.1
Enable NAT	Tick to enable SNAT for OpenVPN. The source IP address of host Behind R3000 will be disguised before accessing the remote OpenVPN server.	Disable
Ping Interval	Set ping interval to check if the tunnel is active.	20
Ping -Restart	Restart to establish the OpenVPN tunnel if ping always timeout during this time.	120
Compression	Select “LZO” to use the LZO compression library to compress the data stream.	LZO
Encryption	Select from “NONE”, “BF-CBC”, “DES-CBC”, “DES-EDE3-CBC”, “AES-128-CBC”, “AES-192-CBC” and “AES-256-CBC”. BF-CBC: Uses the BF algorithm in CBC mode and 128-bit key. DES-CBC: Uses the DES algorithm in CBC mode and 64-bit key. DES-EDE3-CBC: Uses the 3DES algorithm in CBC mode and 192-bit key. AES128-CBC: Uses the AES algorithm in CBC mode and 128-bit key. AES192-CBC: Uses the AES algorithm in CBC mode and 192-bit key. AES256-CBC: Uses the AES algorithm in CBC mode and 256-bit key.	NONE
MTU	Maximum Transmission Unit. It is the identifier of the maximum size of packet, which is possible to transfer in a given environment.	1500
Max Frame Size	Set the Max Frame Size for transmission.	1500
Verbose Level	Select the log output level which from low to high: “ERR”, “WARNING”, “NOTICE” and “DEBUG”. The higher level will output more log information.	ERR
Expert Options	You can enter some other PPP initialization strings in this field. Each string can be separated by a space.	Null
Subnet&Subnet Mask@Local Route	Set the subnet and subnet Mask of local route.	Null

Client

Server

X.509

Enable OpenVPN Server
 Enable OpenVPN Server

Client **Server** X.509

Enable OpenVPN Server

Enable OpenVPN Server

VPN Server Tunnel

Tunnel name:

Listen IP:

Protocol:

Port:

Interface:

Authentication:

Local IP:

Remote IP:

Enable NAT

Ping Interval:

Ping-Restart:

Compression:

Encryption:

MTU:

Max Frame Size:

Verbose Level:

Expert Options:

**--xx xx.parameter, eg: --config xx.config*

Client Manage

Use	Common Name	Password	Client IP	Local Static Route	Remote Static Route
<input type="checkbox"/>					

**Static Route: <1.1.1.0/24> or <1.1.1.0/24;2.2.2.2/16>*

Server @ Open VPN		
Item	Description	Default
Enable OpenVPN Server	Tick to enable OpenVPN server tunnel.	Disable
Tunnel name	Name the OpenVPN server tunnel.	Tunnel_OpenVPN_1
Listen IP	You can enter the IP address of cellular WAN, Ethernet WAN or Ethernet LAN. Null or 0.0.0.0 stands for using the active WAN link currently-cellular WAN or Ethernet WAN.	0.0.0.0
Protocol	Select from "UDP" and "TCP Client" which depends on the application.	UDP
Port	Set the local listening port.	1194

Interface	Select from "tun" and "tap" which are two different kinds of device interface for OpenVPN. The difference between a tun and tap device is this: a tun device is a virtual IP point-to-point device and a tap device is a virtual Ethernet device.	tun
Authentication	Select from four different kinds of authentication ways: "Pre-shared", "Username/Password", "X.509 cert" and "X.509 cert+user".	None
Local IP	Define the local IP address of OpenVPN tunnel.	10.8.0.1
Remote IP	Define the remote IP address of OpenVPN tunnel.	10.8.0.2
Enable NAT	Tick to enable SNAT for OpenVPN. The source IP address of host Behind R3000 will be disguised before accessing the remote OpenVPN client.	Disable
Ping Interval	Set ping interval to check if the tunnel is active.	20
Ping -Restart	Restart to establish the OpenVPN tunnel if ping always timeout during this time.	120
Compression	Select from "None" and "LZO", Select "LZO" to use the LZO compression library to compress the data stream.	LZO
Encryption	Select from "NONE", "BF-CBC", "DES-CBC", "DES-EDE3-CBC", "AES128-CBC", "AES192-CBC" and "AES256-CBC". BF-CBC: Uses the BF algorithm in CBC mode and 128-bit key. DES-CBC: Uses the DES algorithm in CBC mode and 64-bit key. DES-EDE3-CBC: Uses the 3DES algorithm in CBC mode and 192-bit key. AES128-CBC: Uses the AES algorithm in CBC mode and 128-bit key. AES192-CBC: Uses the AES algorithm in CBC mode and 192-bit key. AES256-CBC: Uses the AES algorithm in CBC mode and 256-bit key.	NONE
MTU	Maximum Transmission Unit. It is the identifier of the maximum size of packet, which is possible to transfer in a given environment.	1500
Max Frame Size	Set the Max Frame Size for transmission.	1500
Verbose Level	Select the log output level which from low to high: "ERR", "WARNING", "NOTICE" and "DEBUG". The higher level will output more log information.	ERR
Expert Options	You can enter some other PPP initialization strings in this field. Each string can be separated by a space.	Null
Enable HMAC Firewall @ VPN Server Advanced	In order to prevent malicious attacks, such as DOS, UDP port flooding, we generate a "HMAC is firewall"	Disable
Enable Crl @ VPN Server Advanced	Generate a certificate revoked chain file, to prevent someone lost certificate in the future, users access VPN by illegal. You could find the certificate tab of R3000, there is one option for Crl.	Disable
Enable Client to Client @ VPN Server	Uncomment this directive to allow different clients to be able to "see" each other.	Disable

Advanced	By default, clients will only see the server. To force clients to only see the server, you will also need to appropriately firewall the server's TUN/TAP interface.	
Enable Dup Client @ VPN Server Advanced	While establish OpenVPN with keys, must open this option, otherwise only allows one VPN connection with the same certificate.	Disable
Enable IP Persist @ VPN Server Advanced	Maintain a record of client <-> virtual IP address associations in this file. If OpenVPN goes down or is restarted, reconnecting clients can be assigned the same virtual IP address from the pool that was previously assigned.	Enable
Enable IP pool @ VPN Server Advanced	Define the range of virtual IP address.	Disable
IP Pool Start	Define start virtual IP address	10.8.0.5
IP Pool End	Define end virtual IP address	10.8.0.254
Client Manage	Click "Add" to add a OpenVPN client info which include "Common Name", "Password", "Client IP", "Local Static Route" and "Remote Static Route". This field only can be configured when you select "Username/Password" in "Authentication".	Null

Note: "VPN Server Advanced" will show up when you select "Authentication" type as "Username/Password", "X.509 cert" and "X.509 cert+user".

Client
Server
X.509

Authentication Manage

Select Cert Type: None ▼

Authentication Status

Cert Type	CA	Public Key	Private K..	DH	TA	CRL	PKCS12	Pre-Share
Server								
Client_1								
Client_2								
Client_3								

X.509 @ Open VPN		
Item	Description	Default
Select Cert Type	Select the OpenVPN client or server which the certification used for.	Null
CA	Click "Browse" to select the correct CA file from your PC, and then click "Import" to import it to the router. Click "Export" you can export the CA file from router to your PC.	Null
Public Key	Click "Browse" to select the correct Public Key file from your PC, and then click "Import" to import it to the router. Click "Export" you can export the Public Key A file from router to your PC.	Null
Private Key	Click "Browse" to select the correct Private Key file from your PC, and then click	Null

	<p>“Import” to import it to the router. Click “Export” you can export the Private Key file from router to your PC.</p>	
DH	<p>Click “Browse” to select the correct DH A file from your PC, and then click “Import” to import it to the router. Click “Export” you can export the DH file from router to your PC.</p>	Null
TA	<p>Click “Browse” to select the correct TA file from your PC, and then click “Import” to import it to the router. Click “Export” you can export the TA file from router to your PC.</p>	Null
CRL	<p>Click “Browse” to select the correct CRL file from your PC, and then click “Import” to import it to the router. Click “Export” you can export the CRL file from router to your PC.</p>	Null
PKCS12	<p>Click “Browse” to select the correct PKCS12file from your PC, and then click “Import” to import it to the router. Click “Export” you can export the PKCS12file from router to your PC.</p>	Null
Pre-Share	<p>Click “Browse” to select the correct Pre-Share Static Key file from your PC, and then click “Import” to import it to the router. Click “Export” you can export the Pre-Share Static Key file from router to your PC.</p>	Null

3.25 Configuration -> GRE

This section allows users to set the GRE parameters.

GRE

Enable

Remote IP Address:

Local Virtual IP:

Remote Virtual IP:

Remote Subnet List

Remote Subnet	Remote Subnet Mask	Add
---------------	--------------------	-----

All traffic via this interface

Enable NAT

Secrets:

GRE		
Item	Description	Default
Add	Click “Add” to add a GRE tunnel.	
Enable	Click to enable GRE (Generic Routing Encapsulation). GRE is a protocol that encapsulates packets in order to route other protocols over IP networks.	Disable

Remote IP Address	Set remote IP Address of the virtual GRE tunnel.	Null
Local Virtual IP	Set local IP Address of the virtual GRE tunnel.	Null
Remote virtual IP	Set remote IP Address of the virtual GRE tunnel.	Null
Remote Subnet @ Remote Subnet List	Add a static route to the remote side's subnet so that the remote network is known to the local network. The max count is 10.	Null
Remote Subnet Mask @ Remote Subnet List	Set remote subnet net mask. The max count is 10.	Null
All traffic via this interface	After click to enable this feature, all data traffic will be sent via GRE tunnel.	Disable
Enable NAT	Tick to enable SNAT for GRE. The source IP address of host Behind R3000 will be disguised before accessing the remote GRE server.	Disable
Secrets	Set Tunnel Key of GRE.	Null

3.26 Configuration -> L2TP

This section allows users to set the L2TP parameters.

L2TP Client
L2TP Server

L2TP Client

Tunnel name	Description	
	<input type="button" value="Add"/>	

L2TP Client

Enable

Remote IP Address:

Username:

Password:

Authentication:

Remote Subnet:

Remote Subnet Mask:

Enable NAT

All traffic via this interface

Enable Tunnel Authentication

Show Advanced

Port:	<input type="text" value="1701"/>
Local IP:	<input type="text"/>
Remote IP:	<input type="text"/>
<input checked="" type="checkbox"/> Address/Control Compression	
<input checked="" type="checkbox"/> Protocol Field Compression	
Asyncmap Value:	<input type="text" value="ffffffff"/>
MRU:	<input type="text" value="1500"/>
MTU:	<input type="text" value="1436"/>
Link Detection Interval (s):	<input type="text" value="30"/>
Link Detection Max Retries:	<input type="text" value="5"/>
Expert Options:	<input type="text" value="nocc p nobsdcomp"/>

L2TP Client @ L2TP		
Item	Description	Default
Add	Click "Add" to add a L2TP client. You can add at most 3 L2TP clients.	Null
Remote IP Address	Enter your L2TP server's public IP or domain name.	Null
Username	Enter the username which was provided by your L2TP server.	Null
Password	Enter the password which was provided by your L2TP server.	Null
Authentication	Select from "Auto", "PAP", "CHAP", "MS-CHAP v1" and "MS-CHAP v2". You need to select the corresponding authentication method based on the server's authentication method. When you select "Auto", router will auto select the correct method based on server.	Disable
Remote Subnet	Enter L2TP remote Protected subnet's address.	Null
Remote Subnet Mask	Enter L2TP remote Protected subnet's mask.	Null
Enable NAT	Click to enable NAT feature of L2TP. The source IP address of host Behind R3000 will be disguised before accessing the remote L2TP server.	Disable
All traffic via this interface	After click to enable this feature, all data traffic will be sent via L2TP tunnel.	Disable
Enable Tunnel Authentication	Tick to enable tunnel authentication and enter the tunnel secret which provided by L2TP server.	Disable
Tunnel Secret	Enter L2TP tunnel secret in this item.	Null
Show Advanced	Tick to enable the L2TP client advanced setting.	Disable
Port	Set the Port number of the L2TP client.	Null
Local IP	Set the IP address of the L2TP client. You can enter the IP which assigned by L2TP server. Null means L2TP client will obtain an IP address automatically from L2TP server's IP pool.	Null
Remote IP	Enter the remote peer's private IP address or remote subnet's gateways address.	Null
Address/Control	Used for PPP initialization. In general, you need to enable it as default.	Enable

Compression		
Protocol Field Compression	Used for PPP initialization. In general, you need to enable it as default.	Enable
Asyncmap Value	One of the L2TP initialization strings. In general, you don't need to modify this value.	ffffff
MRU	Maximum Receiving Unit. It is the identifier of the maximum size of packet, which is possible to receive in a given environment.	1500
MTU	Maximum Transmission Unit. It is the identifier of the maximum size of packet, which is possible to transfer in a given environment.	1436
Link Detection Interval	Specify the interval between L2TP client and server. To check the connectivity of a tunnel, the client and server regularly send PPP Echo to each other. If the client or server receives no response from the peer within a specified period of time, it retransmits the PPP echo. If it receives no response from the peer after transmitting the PPP echo for max retries times, it considers that the L2TP tunnel is down and tries to re-establish a tunnel with the peer.	30
Link Detection Max Retries	Specify the max retries times for L2TP link detection.	5
Expert Options	You can enter some other PPP initialization strings in this field. Each string can be separated by a space.	noccp nobsdcomp

L2TP Client **L2TP Server**

Enable L2TP Server

Enable L2TP Server

L2TP Common Settings

Username:

Password:

Authentication: ▼

Enable Tunnel Authentication

Local IP:

IP Pool Start:

IP Pool End:

L2TP Server Advanced

Show L2TP Server Advanced

Address/Control Compression

Protocol Field Compression

Port:

Asyncmap Value:

MRU:

MTU:

Link Detection Interval (s):

Link Detection Max Retries:

Expert Options:

Route Table List

Client IP	Remote Subnet	Remote Subnet Mask
<i>*0.0.0.0" means any</i>		
<input type="button" value="Add"/>		

L2TP Server @ L2TP		
Item	Description	Default
Enable L2TP Server	Tick to enable L2TP server.	Disable
Username	Set the username which will assign to L2TP client.	Null
Password	Set the password which will assign to L2TP client.	Null
Authentication	Select from "PAP", "CHAP", "MS-CHAP v1" and "MS-CHAP v2". L2TP client need to select the same authentication method based on this server's authentication method.	CHAP
Enable Tunnel Authentication	Tick to enable tunnel authentication and enter the tunnel secret which will provide to L2TP client.	Disable
Local IP	Set the IP address of L2TP server.	10.0.0.1
IP Pool Start	Set the IP pool start IP address which will assign to the L2TP clients.	10.0.0.2
IP Pool End	Set the IP pool end IP address which will assign to the L2TP clients.	10.0.0.100
Show L2TP Server Advanced	Tick to show the L2TP server advanced setting.	Disable
Address/Control Compression	Used for PPP initialization. In general, you need to enable it as default.	Enable
Protocol Field Compression	Used for PPP initialization. In general, you need to enable it as default.	Enable
Port	Set the Port number of the L2TP server.	Null
Asyncmap Value	One of the L2TP initialization strings. In general, you don't need to modify this value.	ffffffff
MRU	Maximum Receiving Unit. It is the identifier of the maximum size of packet, which is possible to receive in a given environment.	1500
MTU	Maximum Transmission Unit. It is the identifier of the maximum size of packet, which is possible to transfer in a given environment.	1436

Link Detection Interval	Specify the interval between L2TP client and server. To check the connectivity of a tunnel, the client and server regularly send PPP Echo to each other. If the client or server receives no response from the peer within a specified period of time, it retransmits the PPP echo. If it receives no response from the peer after transmitting the PPP echo for max retries times, it considers that the L2TP tunnel is down and tries to re-establish a tunnel with the peer.	30
Link Detection Max Retries	Specify the max retries times for L2TP link detection.	5
Expert Options	You can enter some other PPP initialization strings in this field. Each string can be separated by a space.	noccp nobsdcomp
Route Table List	Click "Add" to add a route rule from L2TP server to L2TP client.	Null

3.27 Configuration -> PPTP

This section allows users to set the PPTP parameters.

PPTP Client
PPTP Server

PPTP Client

Tunnel name	Description
<input type="button" value="Add"/>	

PPTP Client

Enable

Remote IP Address:

Username:

Password:

Authentication:

Enable NAT

Enable MPPE

All traffic via this interface

Show Advanced

Local IP:

Remote IP:

Address/Control Compression

Protocol Field Compression

Asyncmap Value:

MRU:

MTU:

Link Detection Interval (s):

Link Detection Max Retries:

5

Expert Options:

noccp nobsdcomp

PPTP Client @ PPTP		
Item	Description	Default
Add	Click "Add" to add a PPTP client	
Enable	Enable PPTP Client. The max tunnel accounts are 3.	Null
Disable	Disable PPTP Client.	Null
Remote IP Address	Enter your PPTP server's public IP or domain name.	Null
Username	Enter the username which was provided by your PPTP server.	Null
Password	Enter the password which was provided by your PPTP server.	Null
Authentication	Select from "Auto", "PAP", "CHAP", "MS-CHAP v1" and "MS-CHAP v2". You need to select the corresponding authentication method based on the server's authentication method. When you select "Auto", router will auto select the correct method based on server's method.	Auto
Enable NAT	Click to enable NAT feature of PPTP. The source IP address of host Behind R3000 will be disguised before accessing the remote PPTP server.	Disable
Enable MPPE	Tick to enable MPPE (Microsoft Point-to-Point Encryption). It's a protocol for encrypting data across PPP and VPN links.	Disable
All traffic via this interface	After click to enable this feature, all data traffic will be sent via PPTP tunnel.	Disable
Show Advanced	Tick to enable the PPTP client advanced setting.	Disable
Local IP	Set the IP address of the PPTP client. You can enter the IP which assigned by PPTP server. Null means PPTP client will obtain an IP address automatically from PPTP server's IP pool.	Null
Remote IP	Enter the remote peer's private IP address or remote subnet's gateways address.	Null
Address/Control Compression	Used for PPP initialization. In general, you need to enable it as default.	Enable
Protocol Field Compression	Used for PPP initialization. In general, you need to enable it as default.	Enable
Asyncmap Value	One of the PPTP initialization strings. In general, you don't need to modify this value.	ffffff
MRU	Maximum Receiving Unit. It is the identifier of the maximum size of packet, which is possible to receive in a given environment.	1500
MTU	Maximum Transmission Unit. It is the identifier of the maximum size of packet, which is possible to transfer in a given environment.	1436
Link Detection Interval	Specify the interval between PPTP client and server. To check the connectivity of a tunnel, the client and server regularly send PPP Echo to each other. If the client or server receives no response from the peer within a specified period of time, it retransmits the PPP echo. If it receives no response from the peer after transmitting the PPP echo for max retries times,	30

	it considers that the PPTP tunnel is down and tries to re-establish a tunnel with the peer.	
Link Detection Max Retries	Specify the max retries times for PPTP link detection.	5
Expert Options	You can enter some other PPP initialization strings in this field. Each string can be separated by a space.	noccp nobsdcomp

PPTP Client **PPTP Server**

Enable PPTP Server

Enable PPTP Server

PPTP Common Settings

Username:

Password:

Authentication:

Local IP:

IP Pool Start:

IP Pool End:

Enable MPPE

PPTP Server Advanced

Show PPTP Server Advanced

Address/Control Compression

Protocol Field Compression

Asynmap Value:

MRU:

MTU:

Link Detection Interval (s):

Link Detection Max Retries:

Expert Options:

Route Table List

Client IP	Remote Subnet	Remote Subnet Mask
<i>*0.0.0.0" means any</i>		
<input type="button" value="Add"/>		

PPTP Server @ PPTP		
Item	Description	Default
Enable PPTP Server	Tick to enable PPTP server.	Disable
Username	Set the username which will assign to PPTP client.	Null
Password	Set the password which will assign to PPTP client.	Null
Authentication	Select from "PAP", "CHAP", "MS-CHAP v1" and "MS-CHAP v2".	CHAP

	PPTP client need to select the same authentication method based on this server's authentication method.	
Local IP	Set the IP address of PPTP server.	10.0.0.1
IP Pool Start	Set the IP pool start IP address which will assign to the PPTP clients.	10.0.0.2
IP Pool End	Set the IP pool end IP address which will assign to the PPTP clients.	10.0.0.100
Enable MPPE	Tick to enable MPPE (Microsoft Point-to-Point Encryption). It's a protocol for encrypting data across PPP and VPN links.	Disable
Show PPTP Server Advanced	Tick to show the PPTP server advanced setting.	Disable
Address/Control Compression	Used for PPP initialization. In general, you need to enable it as default.	Enable
Protocol Field Compression	Used for PPP initialization. In general, you need to enable it as default.	Enable
Asynmap Value	One of the PPTP initialization strings. In general, you don't need to modify this value.	ffffff
MRU	Maximum Receiving Unit. It is the identifier of the maximum size of packet, which is possible to receive in a given environment.	1500
MTU	Maximum Transmission Unit. It is the identifier of the maximum size of packet, which is possible to transfer in a given environment.	1436
Link Detection Interval	Specify the interval between PPTP client and server. To check the connectivity of a tunnel, the client and server regularly send PPP Echo to each other. If the client or server receives no response from the peer within a specified period of time, it retransmits the PPP echo. If it receives no response from the peer after transmitting the PPP echo for max retries times, it considers that the PPTP tunnel is down and tries to re-establish a tunnel with the peer.	30
Link Detection Max Retries	Specify the max retries times for PPTP link detection.	5
Expert Options	You can enter some other PPP initialization strings in this field. Each string can be separated by a space.	noccp nobsdcom p
Route Table List	Click "Add" to add a route rule from PPTP server to PPTP client.	Null

3.28 Configuration -> SNMP

This section allows users to set the SNMP parameters.

SNMP Basic Settings

Enable SNMP

Port:

Agent Mode:

Version:

Location Info:

Contact Info:

System Name:

Basic @ SNMP		
Item	Description	Default
Port	UDP port for sending and receiving SNMP requests.	161
Agent Mode	Select the correct agent mode.	Master
Version	Select from "SNMPv1", "SNMPv2" and "SNMPv3".	SNMPv2
Location Info	Enter the router's location info which will send to SNMP client.	China
Contact Info	Enter the router's contact info which will send to SNMP client.	info@robustel.com
System name	Enter the router's system name which will send to SNMP client.	router

Mib View List

View Name	View Filter	View OID
system	Included	1.3.6.1.2.1.1
all	Included	1

**View OID: <1~65535>.<1~65535>...*

View @ SNMP		
Item	Description	Default
View Name	Enter the View Name	Null
View Filter	Select from "Include" and "Exclude".	Include
View OID	Enter the Object Identifiers (OID)	Null

SNMPv1&v2 User List

Readwrite	Network	Community	MIBview
Readonly	0.0.0.0	public	system
ReadWrite	0.0.0.0	private	system
ReadWrite	0.0.0.0	admin	all

**Network: 1.1.1.0/24, 0.0.0.0 means any*

VACM @ SNMP		
Item	Description	Default
Readwrite	Select the access rights from "Readonly" and "ReadWrite".	Readonly
Network	Define the network from which is allowed to access. E.g. 172.16.0.0.	Null
Community	Enter the community name.	Null
MIBview	Select from "none", "system" and "all"	none

Basic
View
VACM
Trap
Download MIB..

SNMP Trap Settings

Enable SNMP Trap

Version:

Server Address:

Port:

Name:

Trap @ SNMP		
Item	Description	Default
Enable SNMP Trap	Click to enable SNMP Trap feature.	Disable
Version	Select from "SNMPv1", "SNMPv2" and "SNMPv3".	SNMPv2
Server Address	Enter SNMP server's IP address.	Null
Port	Enter SNMP server's port number	0
Name	Enter SNMP server's name.	Null

Basic
View
VACM
Trap
Download MIB..

Download MIB Moudles File

[Download MIB Moudles File](#)

Download MIB Moudles File @ SNMP		
Item	Description	
Download MIB Moudles File	Click to download the MIB Moudles File	

3.29 Configuration -> VRRP

This section allows users to set the VRRP parameters.

VRRP

VRRP Settings

Enable VRRP

Group ID:

Priority:

Interval (s):

Virtual IP:

VRRP		
Item	Description	Default
Enable VRRP	Tick to enable VRRP protocol. VRRP (Virtual Router Redundancy Protocol) is an Internet protocol that provides a way to have one or more backup routers when using a statically configured router on a local area network (LAN). Using VRRP, a virtual IP address can be specified manually.	Disable
Group ID	Specify which VRRP group of this router belong to.	1
Priority	Enter the priority value from 1 to 255. The larger value has higher priority.	100
Interval	The interval that master router sends keepalive packets to backup routers.	10
Virtual IP	A virtual IP address is shared among the routers, with one designated as the master router and the others as backups. In case the master fails, the virtual IP address is mapped to a backup router's IP address. (This backup becomes the master router.)	192.168.0.1

3.30 Configuration -> AT over IP

This section allows users to set the AT over IP parameters.

AT over IP

AT Settings

Enable AT Settings

Protocol:

Local IP:

Local Port:

AT over IP		
Item	Description	Default
Enable AT Settings	Tick to enable AT over IP to control cellular module via AT command remotely.	Disable
Protocol	Select from "TCP server" or "UDP"	UDP
Local IP	You can enter the IP address of cellular WAN, Ethernet WAN or Ethernet LAN. Null stands for all these three IP addresses.	0.0.0.0
Local Port	Enter the local TCP or UDP listening port.	8091

3.31 Configuration -> Phone Book

This section allows users to set the Phone Book parameters.

Phone Book
Phone Group

Phone Book Configuration

Description	Phone No.

X

Add

**1. Make sure you enter mobile destination number in the international format, for instance for SMS to US mobile phone: +12342342342 (+1 is the international code for US, use this and then your normal number without the first zero).*

**2. In some countries, only can send/receive SMS without international code for the number.*

Phone Book		
Item	Description	Default
Description	Set the name to your relevant phone No.	Null
Phone No.	Enter your phone No. Note: <i>In some countries, the Phone NO. is required to be written in international format, starting with “+” followed by the country code.</i>	Null

Phone Book
Phone Group

Phone Group Configuration

Group Name	Phone List

Add

Group No. And Description

Group Name:

Add or remove the phone no. to/from group

Not in this group
In this group

➔
 All
➔

Phone Group		
Group Name	Set the Group Name.	Null
Phone List	Show the phone list in the Group.	Null
Add or remove the phone no.to/from group	Click right arrow to add the phone no.to this group; Click left arrow to remove the phone no.from group.	Null

Note: R3000-4L does not support SMS/Call function, so PhoneBook section will not be displayed on the web page.

3.32 Configuration -> SMS

This section allows users to set the SMS Notification and SMS Control parameters.

SMS

SMS Notification

Send SMS on power up
 Send SMS on PPP connect
 Send SMS on PPP disconnect
 Phone Group: NULL [Click to add PhoneGroup!](#)

SMS Control

Enable
 Password Content:
 Phone Group: NULL [Click to add PhoneGroup!](#)

SMS		
Item	Description	Default
Send SMS on power up	Enable to send SMS to specific user after router was powered up.	Disable
Send SMS on PPP connect	Enable to send SMS to specific user when router PPP up.	Disable
Send SMS on PPP disconnect	Enable to send SMS to specific user when router PPP down.	Disable
Phone Group	Select the Phone Group you set in 3.2.27 Configuration -> Phone Book	Null
Enable @ SMS Control	Click to enable SMS remote control.	Disable
Password Content	Set the password content characters. Note: Only support text format. For example 123 or ABC123.	Null
Phone Group	Select the Phone Group you set in 3.2.27 Configuration -> Phone Book	Null

Note: please refer to section 4.7 SMS Commands for Remote Control. R3000-4L does not support SMS/Call function, SMS section will not be displayed on the web page.

3.33 Configuration -> Reboot

This section allows users to set the Reboot policies.

Time
Call
SMS

Daily Reboot

Enable Time Reboot(hh:mm,24h)

Reboot Time1	Reboot Time2	Reboot Time3
12:00		

Time
Call
SMS

Call Reboot Configuration

Enable Call Reboot

Phone Group: NULL [Click to add PhoneGroup!](#)

SMS Reply Content:

SMS Reboot Configuration

Enable SMS Reboot

Phone Group: NULL [Click to add PhoneGroup!](#)

Password:

SMS Reply Content:

Time @ Reboot		
Item	Description	Default
Enable(ahh:mm,24h)	Enable daily reboot, you should follow ahh:mm,24h time frame, or the data will be invalid.	Disable
Reboot Time1	Specify time1 when you need router reboot.	Null
Reboot Time2	Specify time2 when you need router reboot.	Null
Reboot Time3	Specify time3 when you need router reboot.	Null
Call @ Reboot		
Enable Call Reboot	Click to enable call reboot function	Disable
Phone Group	Set the Phone Group which was allowed to reboot the router by call.	Null
SMS Reply Content	Send reply short message after auto Call reboot from specified Caller ID (e.g. Reboot ok!). Note: Only support text format SMS.	Null
SMS @ Reboot		
Enable SMS Reboot	Click to enable SMS reboot function	Disable
Phone Group	Set the Phone Group which was allowed to reboot the router by SMS.	Null
Password	Password for triggering the Reboot mechanism.	Null
SMS Reply Content	Send reply short message after auto SMS reboot from specified Caller ID (e.g. Reboot ok!). Note: Only support text format SMS.	Null

Note: R3000-4L does not support SMS/Call function, Call and SMS section will not be displayed on the web page.

3.34 Configuration -> Portal

This section allows users to configure parameters about RobustLink, Tingco Cumulosity and GpsGate, which are industrial-grade centralized management and administration system. It allows you to monitor, configure and manage large numbers of remote devices on a private network over the web.

Password	Enter the password preset in RobustLink. <i>Note: The passwords set in R3000 and RobustLink need to be the same.</i>	Null
Tingco@ Portal		
Server Address, Port, UnitID,CLID, KeepAlive	Fill in the Server Address, Port, UnitID, CLID, KeepAlive. After settings are activated, R3000 will update information to Tingco automatically.	
Cumulosity@Portal		
URL, Username, Password, Device Name, Device ID (S), KeepAlive	Fill in the URL, Username, Password, Device Name, Device ID (S), KeepAlive of Cumulosity. Default settings will be ok. After settings are activated, R3000 will update information to Cumulosity automatically.	
GpsGate@Portal		
GpsGate	Connect to GpsGate portal. You should configure the GpsGPS Setting at first.	

3.35 Configuration -> Syslog

This section allows users to set the syslog parameters.

Syslog

Syslog Settings

Save Position: RAM

Log Level: DEBUG

Keep Days: 14

Log to Remote System

Remote IP:

Remote UDP Port: 514

Syslog		
Item	Description	Default
Save Position	Select the save position from “None”, “Flash” and “SD”. “None” means syslog is only saved in RAM, and will be cleared after reboot.	NONE
Log Level	Select form “DEBUG”, “INFO”, “NOTICE”, “WARNING”, “ERR”, “CRIT”, “ALERT” and “EMERG” which from low to high. The lower level will output more syslog in detail.	DEBUG
Keep Days	Specify the syslog keep days for router to clear the old syslog.	14
Log to Remote System	Enable to allow router sending syslog to the remote syslog server. You need to enter the IP and Port of the syslog server.	Disable

3.36 Configuration -> Event

This section allows users to set the Event parameters.

Event

Event Settings

Enable Event

Index	Event Code	SNMP-TRAP	RobustLink
1	BOOT-UP	<input type="checkbox"/>	<input type="checkbox"/>
2	3G-UP	<input type="checkbox"/>	<input type="checkbox"/>
3	3G-DOWN	<input type="checkbox"/>	<input type="checkbox"/>
4	GPRS-UP	<input type="checkbox"/>	<input type="checkbox"/>
5	GPRS-DOWN	<input type="checkbox"/>	<input type="checkbox"/>
6	OVPN1-UP	<input type="checkbox"/>	<input type="checkbox"/>
7	OVPN2-UP	<input type="checkbox"/>	<input type="checkbox"/>
8	OVPN3-UP	<input type="checkbox"/>	<input type="checkbox"/>
9	OVPN1-DOWN	<input type="checkbox"/>	<input type="checkbox"/>
10	OVPN2-DOWN	<input type="checkbox"/>	<input type="checkbox"/>
11	OVPN3-DOWN	<input type="checkbox"/>	<input type="checkbox"/>
12	INT1-UP	<input type="checkbox"/>	<input type="checkbox"/>
13	INT2-UP	<input type="checkbox"/>	<input type="checkbox"/>

Event		
Item	Description	Default
Enable Event	Click to enable Event feature. This feature is used to report R3000's main running event to SNMP-TRAP or RobustLink. There are numbers of Event code you can select, such as "BOOT-UP", "3G-UP", "3G-DOWN", etc. For example if you click "3G-UP" and select "RobustLink" as the server, when R3000 dial up to connect to 3G network, it will send event code "3G-UP" as well as relevant information to RobustLink.	Disable

3.37 Configuration -> USR LED

This section allows users to change the display status of USR LED.

Note: Please refer to "Status" -> "System" -> "LEDs Information" -> "USR".

USR LED

USR LED

USR LED Type:

Indication:

USR LED		
Item	Description	Default
USR LED Type	Select from "VPN", "PPPoE", "DynDNS" and "GPS".	VPN
Indication	Select from "ON", "Blink". For example, if "USR LED Type" is set as "VPN" and "Indication" is set as "Blink", when any VPN tunnel is up USR LED will blink.	ON

3.38 Configuration -> RobustVPN

This section allows users to configure the settings of RobustVPN, which is based on a hosted web service designed to connect customer to their machines through Internet. The hosted acts as data transit platform and offer communication originated by the customers to their machines. It is intended to be used in the industrial M2M communication sector.

RobustVPN

RobustVPN Connection Settings

Enable RobustVPN

Server Address:

HTTPS Port:

Username:

Password:

RobustVPN Status

Status: Disconnected

Local IP:

Remote IP:

Connect Time:

RobustVPN		
Item	Description	Default
Enable RobustVPN	Click to enable RobustVPN.	Disable
Server Address	Enter the IP address or Domain Name of RobustVPN server.	Null
HTTPS Port	Enter the HTTPS Port of RobustVPN server.	443
Username	Enter the Username of RobustVPN server.	admin
Password	Enter the Password of RobustVPN server.	admin
RobustVPN Status	Show status of RobustVPN, including connection status, Local IP, Remote IP and Connect Time.	

3.39 Administration -> Profile

This section allows users to import or export the configuration file, and restore the router to factory default setting.

Profile

Change Profile

Profile: Standard ▼

Copy settings from current profile to selected profile

Change

All Parameters XML Configuration

XML File: Browse... Import Export

IPsec XML Configuration

IPsec XML File: Browse... Import Export

OpenVPN XML Configuration

OpenVPN XML File: Browse... Import Export

Restore to Factory Default Settings

Restore to Factory Default Settings

Profile		
Item	Description	Default
Profile	This item allow users store different configuration profiles into different positions; or save one configuration profile into different positions just for configuration data backup. Selected from "Standard", "Alternative 1", "Alternative 2", "Alternative 3".	Standard
All Parameters XML Configuration	Import: Click "Browse" to select the XML file in your computer, then click "Import" to import this file into your router. Export: Click "Export" and the configuration will be showed in the new popup browser window, then you can save it as a XML file.	/
IPsec XML Configuration	Only import or export the IPsec XML configuration.	/
OpenVPN XML Configuration	Only import or export the OpenVPN XML configuration.	/
Restore to Factory Default Settings	Click the button of "Restore to Factory Default Settings" to restore the router to factory default setting.	/

3.40 Administration -> Tools

This section provides users four tools: Ping, AT Debug, Traceroute and Test.

Ping
AT Debug
Traceroute
Sniffer
Test

Ping

Ping IP address:

Number of requests:

Timeout (s):

Local IP:

Ping @ Tools		
Item	Description	Default
Ping IP address	Enter the ping destination IP address or domain name.	Null
Number of requests	Specify the number of ping requests.	5
Timeout	Specify timeout of ping request.	1
Local IP	Specify the local IP from cellular WAN, Ethernet WAN or Ethernet LAN. Null stands for selecting local IP address from these three automatically.	Null
Start	Click this button to start ping request, and the log will be displayed in the follow box.	Null

Ping
AT Debug
Traceroute
Sniffer
Test

Send AT Commands

Receive AT Commands

AT Debug @ Tools		
Item	Description	Default
Send AT Commands	Enter the AT commands which you need to send to cellular module in this box.	Null
Send	Click this button to send the AT commands.	Null
Receive AT Commands	Router will display the AT commands which respond from the cellular module in this box.	Null

Ping
AT Debug
Traceroute
Sniffer
Test

Traceroute

Trace Address:

Trace Hops:

Timeout (s):

Traceroute @ Tools		
Item	Description	Default
Trace Address	Enter the trace destination IP address or domain name.	Null
Trace Hops	Specify the max trace hops. Router will stop tracing if the trace hops has met max value no matter the destination has been reached or not.	30
Timeout	Specify timeout of Traceroute request.	1
Send	Click this button to start Traceroute request, and the log will be displayed in the follow box.	Null

Ping
AT Debug
Traceroute
Sniffer
Test

Sniffer

Interface:

Host:

Protocol:

Count:

Sniffer @ Tools		
Item	Description	Default
Interface	Select form "all", "lo", "imq0", "imq1", "eth0", "gre0", and "ppp0": all: contain all the interface; lo: Local Loopback interface; imq0/1: virtual interface for QoS, which used to limit the download and upload speed; eth0: Ethernet interface; gre0: GRE tunnel interface; ppp0: Cellular PPP interface;	All
Host	Filter the packet that contain the specify IP address.	Null
Protocol	Select from "all", "ip", "arp", "tcp" and "udp".	All
Count	Set the packet number that can be sniffed at a time.	100
Start	Click this button to start the sniffer, and the log will be displayed in the follow box.	Null

- Ping
- AT Debug
- Traceroute
- Sniffer
- Test

Test		
Enable	Description	Result
<input checked="" type="checkbox"/>	SD Test	
<input checked="" type="checkbox"/>	USB Test	
<input checked="" type="checkbox"/>	Flash Test	
<input checked="" type="checkbox"/>	Memory Test	
<input checked="" type="checkbox"/>	Ethernet Test	
<input checked="" type="checkbox"/>	SIM1 Test	
<input checked="" type="checkbox"/>	SIM2 Test	
<input checked="" type="checkbox"/>	Module Test	

Detail

Test @ Tools		
Item	Description	Default
Enable	Click "Enable" to select the hardware component whose status you want to check.	Enable
Description	Select from "SD Test", "USB Test", "Flash Test", "Memory Test", "SIM1 Test", "SIM2 Test" and "Module Test".	N/A
Result	Show the current status of the selected hardware component. There are 3 status "Testing", "Success" and "Failure". Testing: Router is testing the selected hardware component. Success: Correspond hardware component is properly inserted and detected. Failure: Correspond hardware component is not inserted into the router or the router fails to detect.	Null
Show Detail	Show the current test details of the hardware component.	Null
Clear	Clear the current test details of the hardware component.	Null
Note: click "Apply" to start testing.		

3.41 Administration -> Clock

This section allows users to set clock of router and NTP server.

Clock

Real Time Clock Settings

Real Time Clock:

PC Time:

Timezone Setting

Timezone:

GPS Time Synchronization

Sync Time From GPS

NTP Settings

Enable NTP Client

Primary NTP Server:

Secondary NTP Server:

Update Interval (h):

Enable NTP Server

Clock		
Item	Description	Default
Real Time Clock	Router's RTC can be showed and modified in this field.	Null
PC Time	You PC's time can be showed here.	Null
Synchronize	Synchronize router's RTC with PC.	Null
Enable NTP Client	Enable to synchronize the time from NTP server.	Disable
Timezone @ Client	Select your local time zone.	UTC +08:00
Sync Time From GPS @ GPS Time Synchronization	Synchronize router's RTC from GPS.	Disable
Primary NTP Server	Enter primary NTP Server's IP address or domain name.	pool.ntp.org
Secondary NTP Server	Enter secondary NTP Server's IP address or domain name.	Null
Update interval (h)	Enter the interval which NTP client synchronize the time from NTP server.	1
Enable NTP Server	Click to enable the NTP server function of router.	Disable
Timezone @ Server	Select your local time zone.	UTC +08:00

3.42 Administration -> Web Server

This section allows users to modify the parameters of Web Server.

Basic
X.509

Port Settings

HTTP Port:	80
HTTPS Port:	443

Login Parameters

Login Timeout (s):	1800
--------------------	------

Basic
X.509

HTTPS Certificate

Public Key:		Browse...	Import	Export
Private Key:		Browse...	Import	Export

Public Key	Private Key

Basic @ Web Server		
Item	Description	Default
HTTP Port	Enter the HTTP port number you want to change in R3000's Web Server. On a Web server, port 80 is the port that the server "listens to" or expects to receive from a Web client. If you configure the router with other HTTP Port number except 80, only adding that port number then you can login R3000's Web Server.	80
HTTPS Port	Enter the HTTPS port number you want to change in R3000's Web Server. On a Web server, port 443 is the port that the server "listens to" or expects to receive from a Web client. If you configure the router with other HTTPS Port number except 443, only adding that port number then you can login R3000's Web Server. Note: <i>HTTPS is more secure than HTTP. In many cases, clients may be exchanging confidential information with a server, which needs to be secured in order to prevent unauthorized access. For this reason, HTTP was developed by Netscape corporation to allow authorization and secured transactions.</i>	443
Login Timeout (s)	Enter the Login timeout you want to change in R3000's Web Server. After "Login Timeout", R3000 will force to log out the Web GUI and then you need to re-login again to Web GUI.	1800
X.509 @ Web Server		
HTTPS Certificate	In this tab, user can import, export or delete "Public Key" and "Private Key" for HTTPS certification.	Null

3.43 Administration -> User Management

This section allows users to modify or add management user accounts.

Super
Common

User Management

Username:

Old Password:

New Password:

Confirm Password:

Super @ User Management		
Item	Description	Default
Super	One router has only one super user account. Under this account, user has the highest authority include modify and add management user accounts.	Admin
User Management	Set Username and Password. <i>Note: R3000 support SSH2 for management. Details you can check Application Note of R3000.</i>	Null

Super
Common

User Management

Access Level	Username	Password
<input style="margin-right: 20px;" type="button" value="Add"/>		

Common @ User Management		
Item	Description	Default
Common	One router has at most 9 common user accounts. There are two access level of common user account: "ReadWrite" and "ReadOnly".	Null
Access Level	Select from "ReadWrite" and "ReadOnly". ReadWrite: Users can view and set the configuration of router under this level; ReadOnly: Users only can view the configuration of router under this level	Null
Username/ Password	Set Username and Password.	Null
Add	Click this button to add a new account.	Null

3.44 Administration -> SDK Management

This section allows users to set SDK Management parameters of router.

APP
Files

Import Applications

Custom Application List

Disable SDK service if not WAN devices dete...

Enabled	APP Name	Options	Memory(KB)	Running
<input type="checkbox"/>	1.xml		0	N x

APP @ SDK Management		
Item	Description	Default
Import Applications	Click to import APP files in this item.	Null
Custom Application List	This list shows which APP files you have imported to the router, which APP file you want to start up, as well as the running information. Enable: Click to enable the APP file. APP Name: Shows the name of the APP files. Options: It is an optional items, user can choose to configure startup parameters here. Memory (KB): Shows the memory resources occupied by the APP files. Running: Shows whether the APP files are running.	Null
Disable SDK service if not WAN device dete...	Click to run the SDK APP only after WAN interface is up. If you don't click this option, the SDK APP will run before the WAN interface is up.	Disable

APP
Files

Import Files

Custom File List

<input type="button" value="Index"/>	<input type="button" value="File Name"/>
--------------------------------------	--

Files @ SDK Management		
Item	Description	Default
Import Files	Click to import configuration files in this item.	Null
Custom File List	This list shows which Configuration files you have imported to the router.	Null

3.45 Administration -> Update Firmware

This section allows users to update the firmware of router.

Update

Firmware Version

Firmware Version:

Firmware old Version

Firmware old Version

Fall back to old version

Update Firmware

Warning: Do not turn off or operate the Router while updating.

New Firmware:

Update		
Item	Description	Default
Firmware Version	Show the current firmware version.	
Firmware Old Version	Show the old firmware version of the router. Click "Apply" button to fall back to the old version, after updating successfully, you need to reboot router to take effect.	
Update firmware	Click "Select File" button to select the correct firmware in your PC, and then click "Update" button" to update. After updating successfully, you need to reboot router to take effect.	Null

Chapter 4 Configuration Examples

4.1 Interface

4.1.1 Console Port

User can use the console port to manage the router via CLI commands, please check section Introductions for CLI.

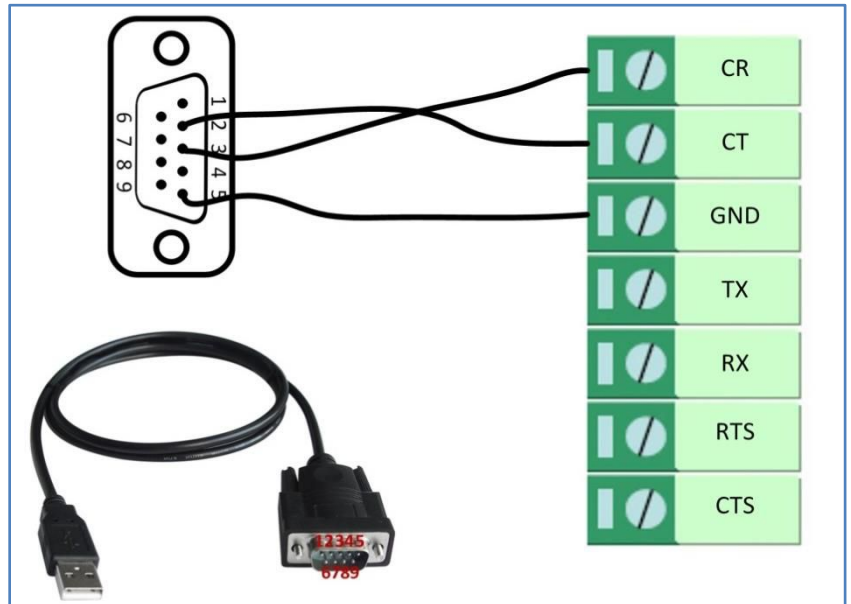

4.1.2 Digital Input

There are two digital inputs of R3000, it support dry contact (do not supports wet contact). Please check the connector interface of R3000, you can find out “V-” easily at one of the pin of power input connector.

Import note: do not connect In1/In2 and Slide switch directly to “GND” of the terminal block, or DI will not work.

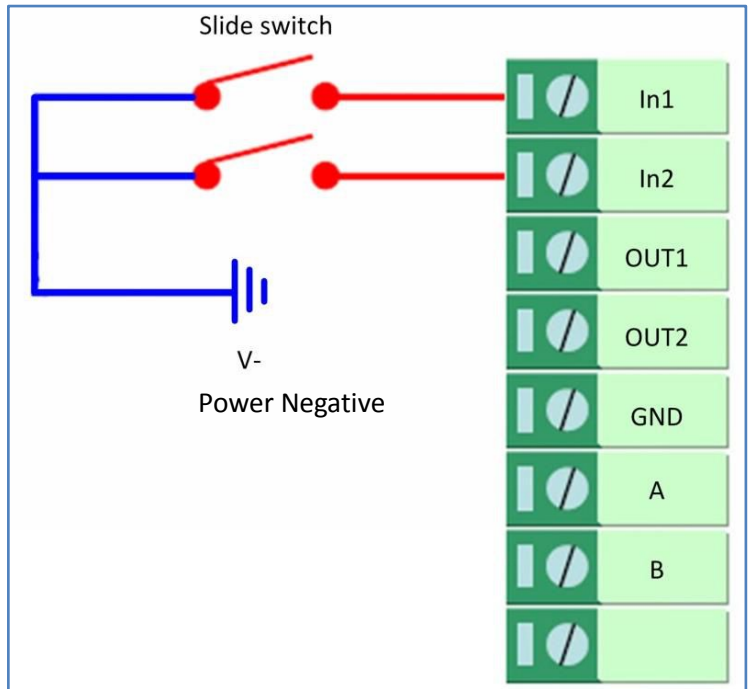

4.1.3 Digital Output

There are two digital outputs of R3000. Power negative of DC should connect to “GND” Please refer to connection diagram at the right site.

Maximum voltage/current/output power of DO is 30VDC/0.3A/0.3W. It means voltage difference between Out1/Out2 and GND cannot exceed to 30VDC; the current value through Out1/Out2 cannot exceed to 300mA. And the output power dissipated by Out1/Out2 cannot exceed to 0.3W. Otherwise DO will be damaged.

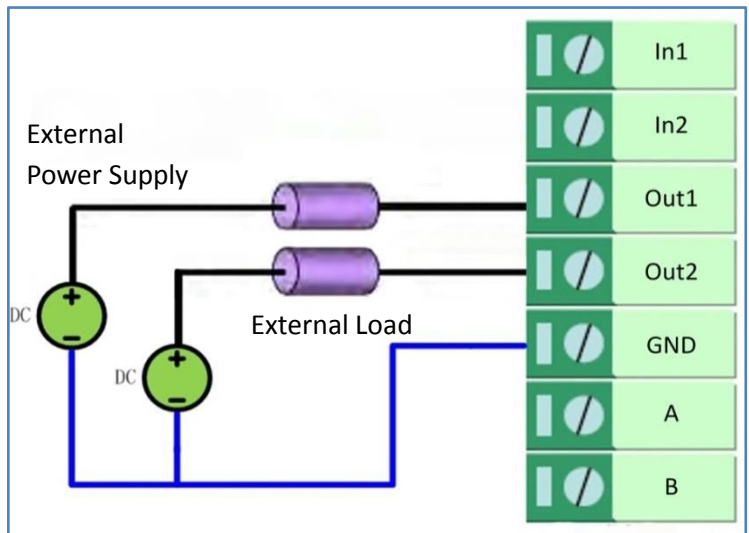

4.1.4 RS232

R3000 supports one RS232 for serial data communication. Please refer to the connection diagram at the right site.

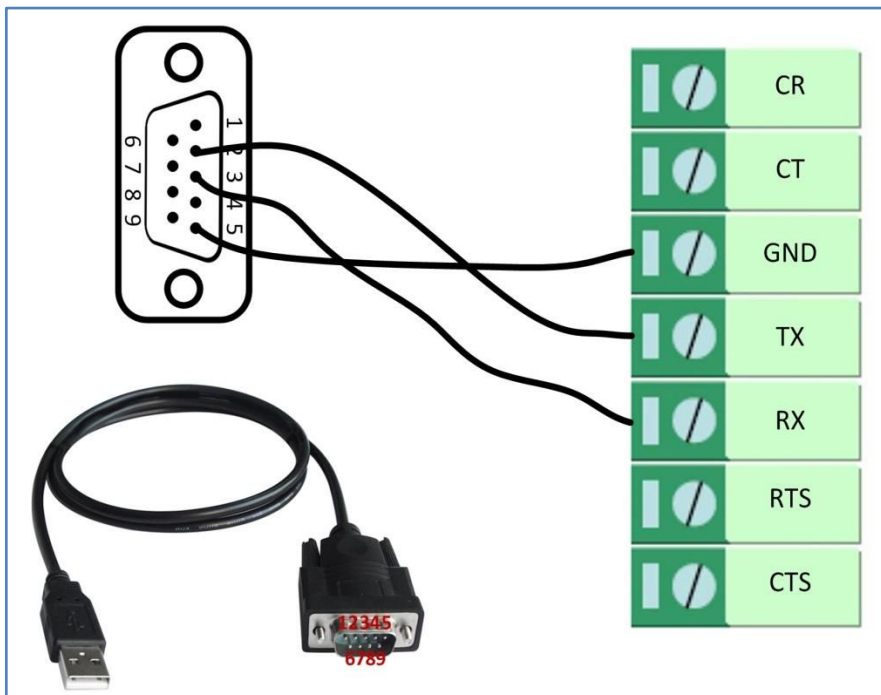

4.1.5 RS485

R3000 supports one RS485 for serial data communication. Please refer to the connection diagram at the right site.

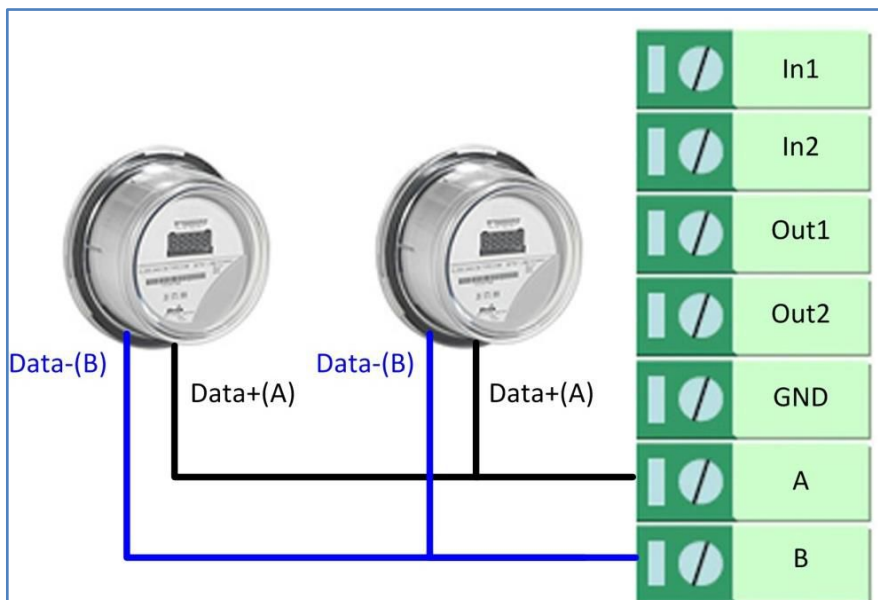

4.2 Cellular

4.2.1 Cellular Dial-Up

This section shows users how to configure the parameters of Cellular Dial-up within two configuration methods: “Always Online” and “Connect on Demand”.

Note: This section will be hidden if user selects “Eth0 Only” in “Configuration ->Link Management”.

1. Always Online

Configuration-->Link Management-->Cellular

Link Management Settings

Primary Interface: Cellular ▾

Backup Interface: None ▾

ICMP Detection Primary Server:

ICMP Detection Secondary Server:

ICMP Detection Interval (s):

ICMP Detection Timeout (s):

ICMP Detection Retries:

Reset The Interface

*It is recommended to use an ICMP detection server to keep router always online.
 *The ICMP detection increases the reliability and also cost data traffic.
 *DNS example: Google DNS Server 8.8.8.8 and 8.8.4.4

The modifications will take effect after click “Apply” button.

Configuration-->Cellular WAN -->Basic

Cellular Settings

	Primary SIM Card	Secondary SIM Card
Network Provider Type:	Auto ▾	Auto ▾
APN:	<input style="width: 100%;" type="text"/>	<input style="width: 100%;" type="text"/>
Username:	<input style="width: 100%;" type="text"/>	<input style="width: 100%;" type="text"/>
Password:	<input style="width: 100%;" type="text"/>	<input style="width: 100%;" type="text"/>
Dialup No.:	<input style="width: 150px;" type="text" value="*99***1#"/>	<input style="width: 150px;" type="text" value="*99***1#"/>
PIN code request:	<input type="button" value="Set PIN Code"/>	<input type="button" value="Set PIN Code"/>

Connection Mode

Connection Mode: Always online ▾

Redial Interval (s):

Max Retries:

Dual SIM Policy

Main SIM Card: ▼

When connection fails

When roaming is detected

When IO is active

Monthly data traffic limitation

The modifications will take effect after click “Apply” button.

If a customized SIM card is using, please select “Custom” instead of “Auto” in “Network Provider Type”, and some relative settings should be filled in manually.

2. Connect on Demand

Configuration-->Link Management-->Cellular

Link Management Settings

Primary Interface: ▼

Backup Interface: ▼

ICMP Detection Primary Server:

ICMP Detection Secondary Server:

ICMP Detection Interval (s):

ICMP Detection Timeout (s):

ICMP Detection Retries:

Reset The Interface

**It is recommended to use an ICMP detection server to keep router always online.*

**The ICMP detection increases the reliability and also cost data traffic.*

**DNS example: Google DNS Server 8.8.8.8 and 8.8.4.4*

The modifications will take effect after click “Apply” button.

Note: This section will be hidden if user selects “Cellular as primary and if fail use Eth0” in “Configuration ->Link Management”.

Configuration-->Cellular WAN -->Basic

Cellular Settings

	SIM1	SIM2
Status:	Ready	Not Ready
Network Provider Type:	Auto <input type="button" value="v"/>	Auto <input type="button" value="v"/>
APN:	<input type="text"/>	<input type="text"/>
Username:	<input type="text"/>	<input type="text"/>
Password:	<input type="text"/>	<input type="text"/>
Dialup No.:	*99***1#	*99***1#
PIN code request:	<input type="button" value="Set PIN Code"/>	<input type="button" value="Set PIN Code"/>

Connection Mode

Connection Mode:

Redial Interval (s):

Max Retries:

Inactivity Time (s):

Serial Output Content:

Triggered by Serial Data

Periodically connect

Periodically connect interval (s):

Time schedule:

Time Range

Name	SUN	MON	TUE	WED	THU	FRI	SAT	Time Range1	Time Range2	Time Range3
schedule_1	<input checked="" type="checkbox"/>	<input checked="" type="checkbox"/>	<input checked="" type="checkbox"/>	<input checked="" type="checkbox"/>	<input checked="" type="checkbox"/>	<input checked="" type="checkbox"/>	<input checked="" type="checkbox"/>	08:10-12:00	14:10-20:15	<input type="text"/>

Select the trigger policy you need.

Note: If you select multiple trigger policies, the router will be triggered under anyone of them.

4.2.2 SMS Remote Status Reading

R3000 supports remote control via SMS. Users can use following commands to get the status of R3000, cannot set new parameters of R3000 at present.

An SMS command has following structure:

Password:cmd1,a,b,c;cmd2,d,e,f;cmd3,g,h,i;...;cmdn,j,k,n

SMS command Explanation:

1. Password: SMS control password is configured at **Basic->SMS Control->Password**, which is an optional parameter.
 - a) When there is no password, SMS command has following structure: **cmd1;cmd2;cmd3;...;cmdn**
 - b) When there is a password, SMS command has following structure: **Password:cmd1;cmd2;cmd3;...;cmdn**
2. cmd1, cmd2, cmd3 to Cmdn, which are command identification number 0001 – 0010.
3. a, b, c to n, which are command parameters.

4. The semicolon character (;) is used to separate more than one commands packed in a single SMS.
5. E.g., 1234:0001

In this command, password is 1234, 0001 is the command to reset R3000.

Cmd	Description	Syntax	Comments
Control Commands			
0001	Reset Device	cmd	if no password, please use command "cmd", or use command" password: cmd" cmd1 + cmd2: cmd1;cmd2 * - means can be null
0002	Save Parameters	cmd	
0003	Save Parameters and Reset Device	cmd	
0004	Start PPP Dialup	cmd	
0005	Stop PPP	cmd	
0006	Switch Sim Card	cmd	
0007	Enable/Disable Event Counter	cmd,channel,flag	channel: 1 - DI_1 2 - DI_2 flag: 0 - disable 1 - enable
0008	Get Event Count Value	cmd,channel	channel: 1 - DI_1 2 - DI_2
0009	Clear Event Count	cmd,channel	channel: 1 - DI_1 2 - DI_2
0010	Clear SIM Card's Data Limitation	cmd,simNumber	simNumber: 1 - SIM_1 2 - SIM_2

4.3 Network

4.3.1 NAT

This section shows users how to set the NAT configuration of router.

Parameter Remote IP defines if access is allowed to route to the Forwarded IP and Port via WAN IP and “Arrives At Port”.

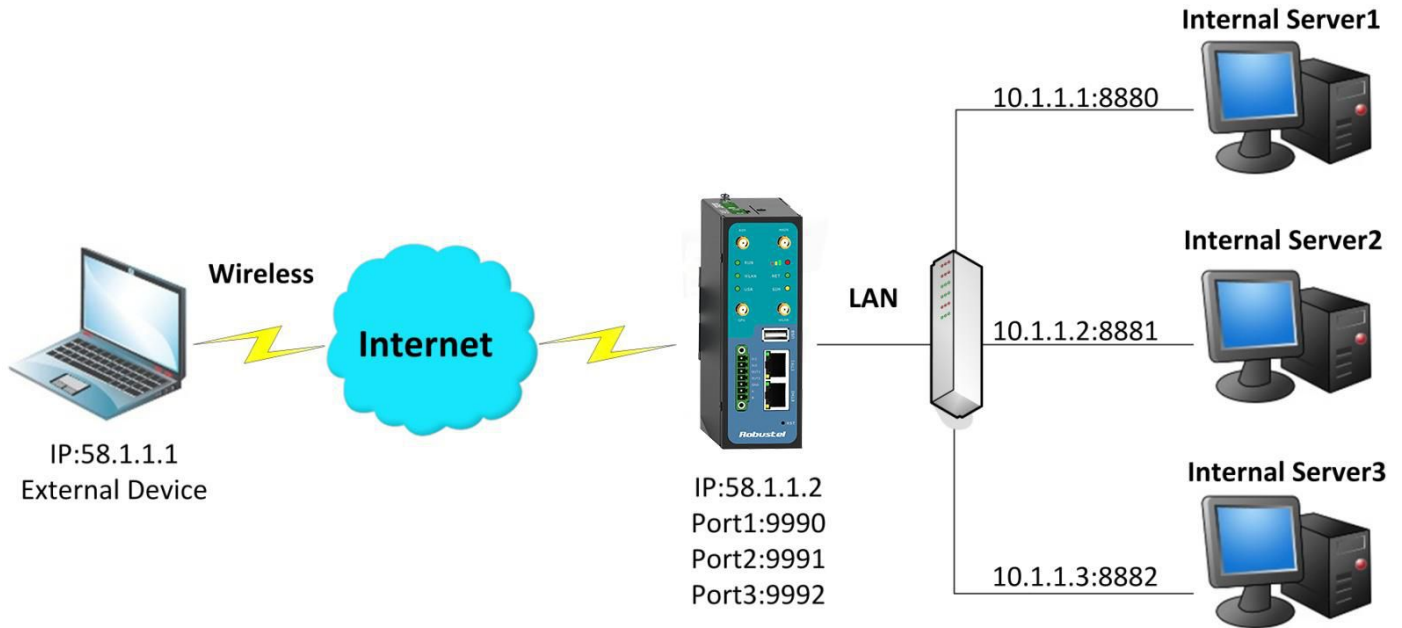

Configuration--->NAT/DMZ--->Port Forwarding

Port Forwarding					
Remote IP	Arrives At Port	Is Forwarded to IP Address	Is Forwarded to Port	Protocol	
58.1.1.1	9990	10.1.1.1	8880	TCP	X
58.1.1.1	9991	10.1.1.2	8881	UDP	X
58.1.1.1	9992	10.1.1.3	8882	TCP&UDP	X

*Remote IP: 1.1.1.1, 1.1.1.0/24, 1.1.1.1-2.2.2.2, 0.0.0.0 means any

*Arrives At Port: <1-65536> or <1-65536>-<1-65536>

Note: This section will be hidden if user selects “Cellular as primary and if fail use Eth0” in “Configuration ->Link Management”.

Explanations for above diagram:

If there are two IP addresses 58.1.1.1 and 59.1.1.1 for the External Devices, that the result will be different from the test when the NAT is working at R3000.

- 58.1.1.1-----access to----->58.1.1.2:9990-----be forwarded to----->10.1.1.1:8000 TCP
- 58.1.1.1-----access to----->58.1.1.2:9991-----be forwarded to----->10.1.1.2:8001 UDP
- 58.1.1.1-----access to----->58.1.1.2:9992-----be forwarded to----->10.1.1.3:8002 TCP&UDP

4.3.2 L2TP

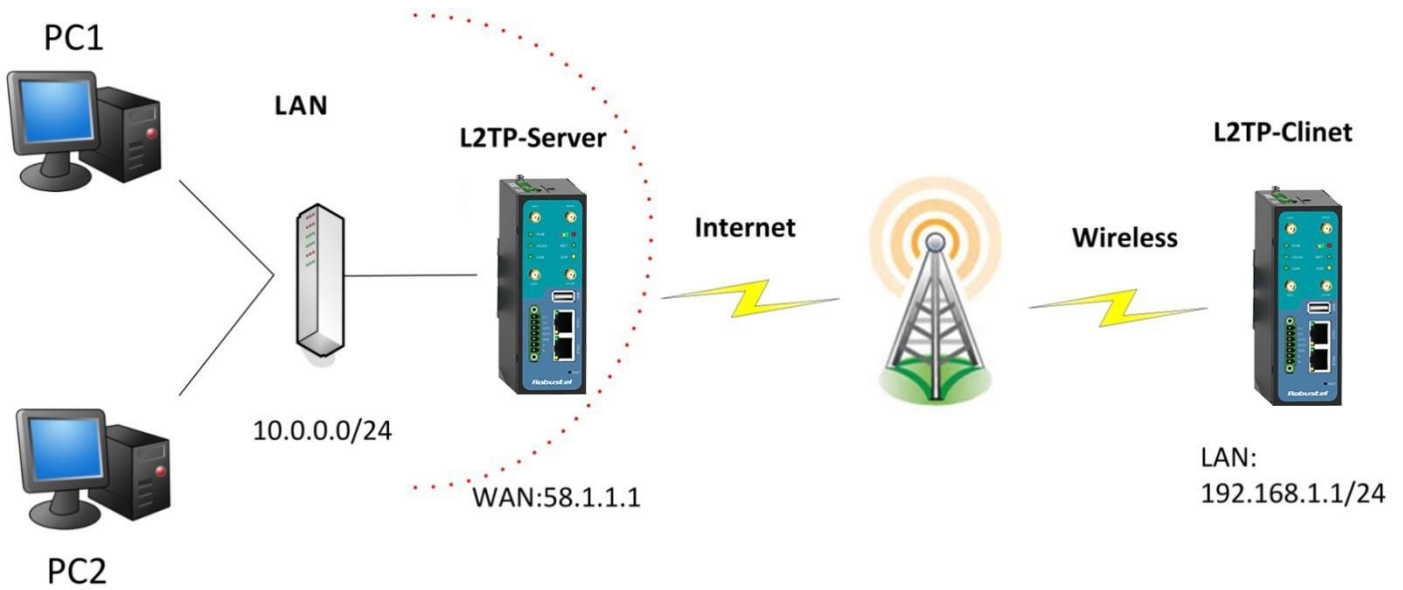

L2TP_SERVER:

Configuration--->L2TP--->L2TP Server

Enable L2TP Server

Enable L2TP Server

Tick "Enable L2TP Server", and fill in the blank textbox

L2TP Common Settings

Username: 1

Password: 2

Authentication: 3

Enable Tunnel Authentication

Local IP:

IP Pool Start:

IP Pool End:

L2TP Server Advanced

Show L2TP Server Advanced

Route Table List

Client IP	Remote Subnet	Remote Subnet Mask	
0.0.0.0	192.168.1.0	255.255.255.0	X

**0.0.0.0" means any*

The modification will take effect after "Apply-->Save-->Reboot".

Note: The following diagrams with red color numbers mean these are the matches between server and client, and with the blue color number means it must be set locally for the tunnel.

L2TP_CLIENT:

Configuration--->L2TP--->L2TP Client

Please add L2TP Client

Click "Add" button, and fill in the blank textbox

L2TP Client ✕

Enable Disable

Server Name:

Username: 1

Password: 2

Authentication: 3

Enable Tunnel Authentication

Remote Subnet:

Remote Subnet Mask:

Show L2TP Client Advanced

The modification will take effect after "Apply-->Save-->Reboot".

4.3.3 PPTP

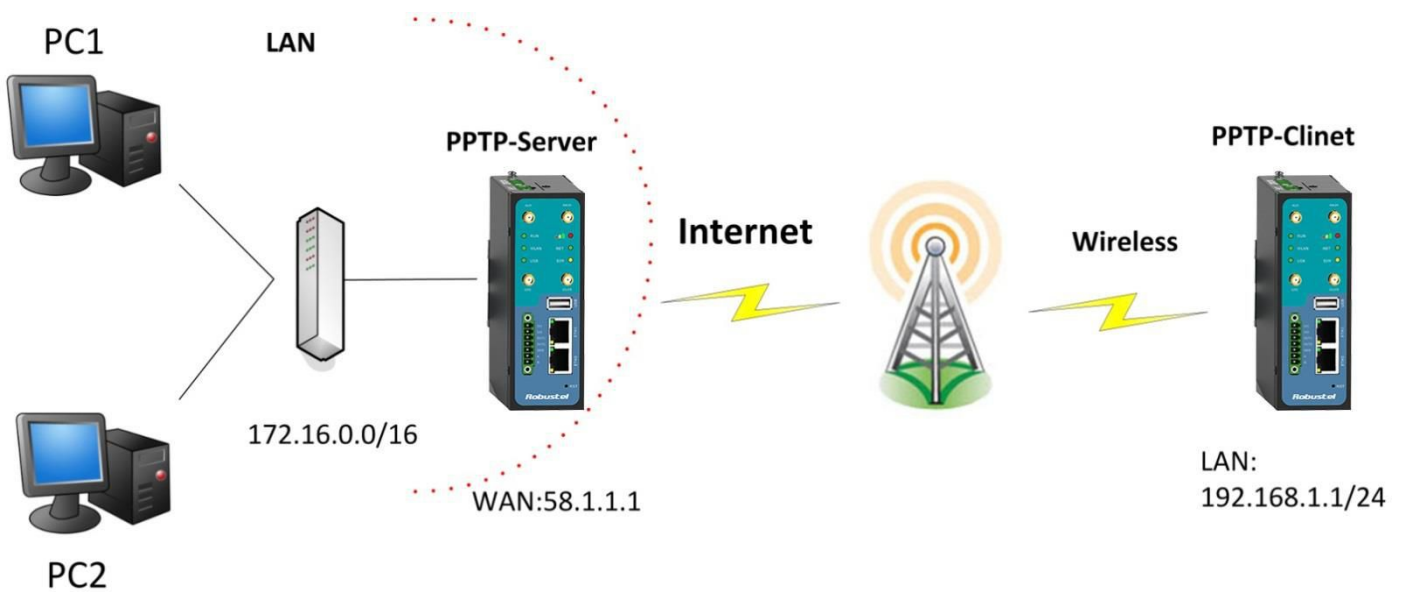

Note: The following diagrams with red color numbers mean these are the matches between server and client, and with the blue color number means it must be set locally for the tunnel.

PPTP_SERVER:

Configuration--->PPTP--->PPTP Server

Enable PPTP Server

Enable PPTP Server

Tick "Enable PPTP Server", and fill in the blank textbox

PPTP Common Settings

Username: **1**

Password: **2**

Authentication: **3**

Local IP:

IP Pool Start:

IP Pool End:

Enable MPPE

PPTP Server Advanced

Show PPTP Server Advanced

Route Table List

Client IP	Remote Subnet	Remote Subnet Mask
0.0.0.0	192.168.1.0	255.255.255.0

**0.0.0.0" means any*

The modification will take effect after "Apply-->Save-->Reboot".

PPTP_CLIENT:

Configuration--->PPTP--->PPTP Client

Please add PPTP Client

Click "Add" button, and fill in the blank textbox

PPTP Client X

Enable Disable

Server Name:

Username: **1**

Password: **2**

Authentication: **3**

Remote Subnet:

Remote Subnet Mask:

Enable MPPE

Show PPTP Client Advanced

The modification will take effect after “Apply-->Save-->Reboot”.

4.3.4 IPSEC VPN

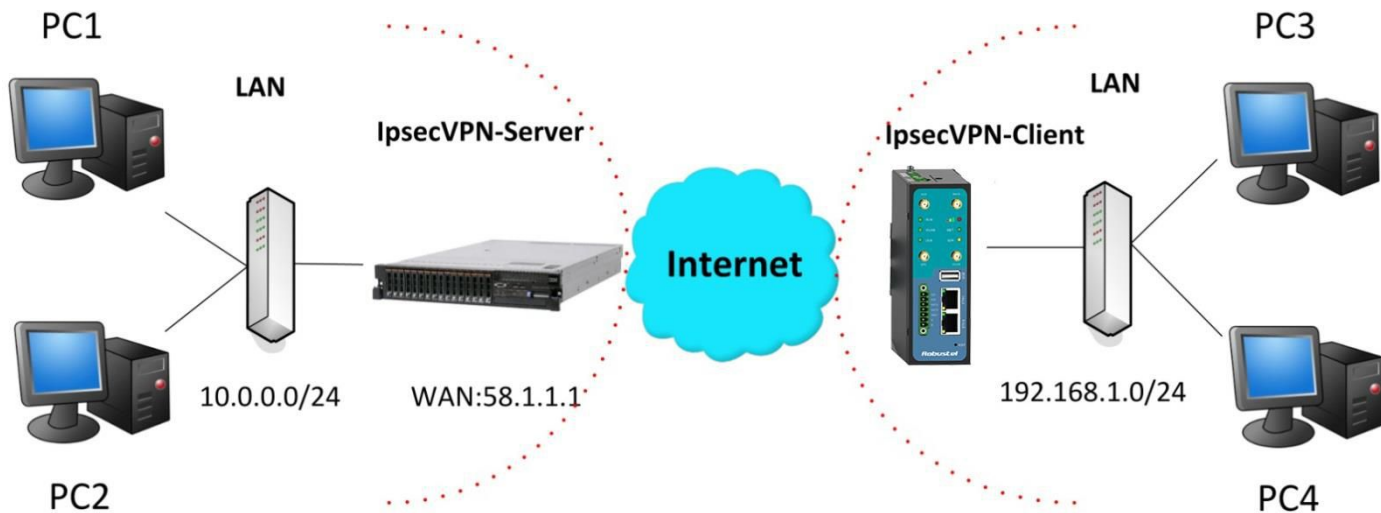

Note: The following diagrams with red color numbers mean these are the matches between server and client, and with the blue color number means it must be set locally for the tunnel.

IPsecVPN_SERVER:**Cisco 2811:**

```

crypto isakmp policy 10
  encr aes 256      8
  hash md5         9
  authentication pre-share 11
  group 2          10
crypto isakmp key cisco address 0.0.0.0 0.0.0.0
!
crypto ipsec transform-set trans esp-3des esp-md5-hmac 2, 13
!
crypto dynamic-map dyn 10
  set transform-set trans
  match address 101
!
crypto map map1 10 ipsec-isakmp dynamic dyn
!
interface FastEthernet0/0
  crypto map map1
!
access-list 101 permit ip 10.0.0.0 0.0.0.255 any 3, 5
!

```

Note: Policies 1,4,6,7 are default for Cisco router and do not display at the CMD.

IPsecVPN_CLIENT:**Configuration--->IPSec--->IPSec Basic**

IPsec Basic	
<input checked="" type="checkbox"/>	Enable NAT Traversal
Keepalive Interval(s):	<input type="text" value="30"/>

Then click "Apply".

Configuration--->IPSec--->IPSec Tunnel

IPsec Tunnel X	
<input checked="" type="radio"/>	Enable
<input type="radio"/>	Disable

Tick "Enable IPsec Tunnel1"

IPsec Common		
Tunnel name:	IPSEC_TUNNEL_1	
IPsec Gateway Address:	58.1.1.1	
IPsec Mode:	Tunnel	1
IPsec Protocol:	ESP	2
Local Subnet:	192.168.1.0	3
Local Subnet Mask:	255.255.255.0	
Local ID Type:	IP Address	4
Remote Subnet:	10.0.0.0	5
Remote Subnet Mask:	255.255.255.0	
Remote ID Type:	IP Address	6
IKE Parameter		
Negotiation Mode:	Main	7
Encryption Algorithm:	AES256	8
Authentication Algorithm:	MD5	9
DH Group:	MODP1024_2	10
Authentication:	PSK	11
Secrets:	•••••	12
Life Time (s):	86400	
SA Parameter		
SA Algorithm:	3DES_MD5_96	13
PFS Group:	PFS_NULL	
Life Time(s):	28800	
DPD Time Interval (s):	180	
DPD Timeout (s):	60	
IPsec Advanced		
VPN Over IPsec Type:	NONE	
<input type="checkbox"/> Enable Compress		

The modification will take effect after “Apply-->Save-->Reboot”.

4.3.5 OPENVPN

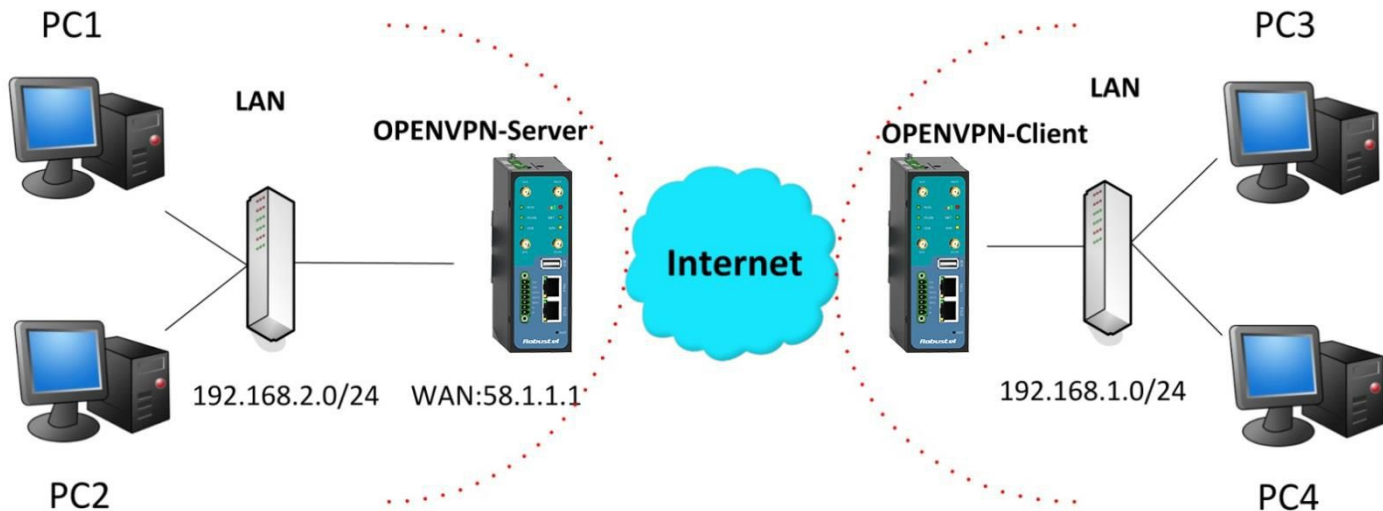

Note: The following diagrams with red color numbers mean these are the matches between server and client, and with the blue color number means it must be set locally for the tunnel.

OPENVPN_SERVER:

Configuration--->OpenVPN--->Server

Enable OpenVPN Server
<input type="checkbox"/> Enable OpenVPN Server

Tick "Enable OpenVPN Server".

VPN Server Tunnel

Tunnel name:

Listen IP:

Protocol: **1**

Port: **2**

Interface: **3**

Authentication: **4**

Local IP: **5**

Remote IP: **6**

Enable NAT **7**

Ping Interval:

Ping-Restart:

Compression: **8**

Encryption: **9**

MTU: **10**

Max Frame Size: **11**

Verbose Level:

Expert Options:

**--xx xx.parameter, eg: --config xx.config*

Client Manage

Use	Common Name	Password	Client IP	Local Static Route	Remote Static Route

**Static Route: <1.1.1.0/24> or <1.1.1.0/24;2.2.2.2/16>*

The modifications will take effect after click “Apply-->Save-->Reboot”.

OPENVPN_CLIENT:

Configuration--->OpenVPN--->Client

Enable OpenVPN Client1

Enable OpenVPN Client1

Tick “Enable OpenVPN Client1”, and fill in the blank textbox

Enable OpenVPN Client X

Enable
 Disable

Tunnel name:

Protocol: 1

Server Address:

Port: 2

Interface: 3

Authentication: 4

Local IP: 6

Remote IP: 5

Enable NAT 7

Ping Interval:

Ping-Restart:

Compression: 8

Encryption: 9

MTU: 10

Max Frame Size: 11

Verbose Level:

Expert Options:

*--xx xx.parameter, eg: --config xx.config

The modification will take effect after “Apply-->Save-->Reboot”.

Chapter 5 Introductions for CLI

5.1 What’s CLI and Hierarchy Level Mode

The R3000 command-line interface (CLI) is a software interface providing another way to set the parameters of equipment from the console or through a telnet network connection. There are four different CLI hierarchy level modes which have different access rights:

- User exec mode—The command prompt “>” shows you are in the user mode , in this mode user can only use some simple commands to see the current configuration and the status of the device, or enter the “ping” command to troubleshoot the network connectivity.
- Privileged exec mode—When you enter Privileged mode ,the prompt will change to “#” which user can do not only what is allowed in the user exec mode but also the new additions like importing and exporting for files , system log , debug and so on .
- Global configuration mode—The global configuration mode with prompt “<config>#” allows user to add, set,modify and delete current configuration .
- Interface mode—Prompt “<config-xx>” means in this mode we can set both IP address and mtu for this interface.

Following is the relationship diagram about how to access or quit among the different modes:

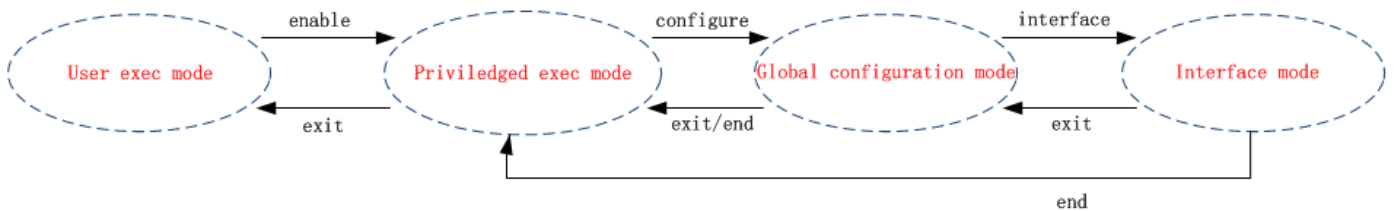

USER EXEC MODE:

R3000 Configure Environment

Username: admin

Password: *****

R3000> ?	//check what commands can be used in user exec mode
enable	Turn on privileged commands
exit	Exit from current mode
ping	Ping test
reload	Halt and perform a cold restart
tracert	Tracert test
show	Show running system information

PRIVILEGED EXEC MODE:

R3000> enable

Password: *****

```
R3000# ? //check what commands can be used in Privileged exec mode
  debug      Debug configure information
  enable     Turn on privileged commands
  exit       Exit from current mode
  export     Export file using tftp
  syslog     Export system log
  import     Import file using tftp
  load       Load configure information
  ping       Ping test
  reload     Halt and perform a cold restart
  tracert    Tracert test
  write      Write running configuration
  tftp       Copy from tftp: file system
  show       Show running system information
  configure  Enter configuration mode
  end       Exit to Normal mode
```

GLOBAL CONFIGURATION MODE:

R3000# configure

```
R3000(config)# ? //check what commands can be used in global configuration mode
  exit      Exit from current mode
  end       Exit to Normal mode
  interface Configure an interface
  set       Set system parameters
  add       Add system parameters list
  modify    Modify system parameters list
  delete    Delete system parameters list
```

INTERFACE MODE:

R3000(config)# interface Ethernet 0

```
R3000(config-e0)# ? //check what commands can be used in interface mode
  exit      Exit from current mode
  end       Exit to Normal mode
  ip        Set the IP address of an interface
  mtu       Set the IP address of an interface
```

5.2 How to Configure the CLI

Following is a list about the description of help and the error should be encountered in the configuring program.

Commands /tips	Description
?	Typing a question mark “?” will show you the help information.
Ctrl+c	Press these two keys at the same time, except its “copy” function but also can be used for “break” out of the setting program.
Invalid command “xxx”	Parameters “xxx” are not supported by the system, in this case, enter a mark “?” instead of “xxx” will help to find out the correct parameters about this issue.
Incomplete command	Command is not incomplete.
% Invalid input detected at '^' marker	'^' marker indicates the location where the error is.

Note: Most of the parameters setting are in the **Global configuration mode**. Commands **set** ,**add** are very important for this mode. If some parameters can't be found in the Global configuration mode, please move back to **Privileged exec mode** or move up to **Interface mode**.

Note: Knowing the **CLI hierarchy level modes** is necessary before configuring the CLI. If not, please go back and read it quickly in chapter 5.

5.2.1 QuickStart with Configuration Examples

The best and quickest way to master CLI is firstly to view all features from the webpage and then reading all CLI commands at a time , finally learn to configure it with some reference examples .

Example 1: Show current version

```
R3000> show version
software version : 1.01.00
kernel version   : v2.6.39
hardware version : 1.01.00
```

Example 2: Update firmware via tftp

```
R3000> enable
Password: *****
R3000#
R3000# tftp 172.16.3.3 get rootfs R3k.1.01.00.02_130325

Tftp transferring
tftp succeeded!downloaded
R3000# write                               //save current configuration
```

Building configuration...

OK

R3000#reload

!Reboot the system?'yes'or 'no':yes //reload to take effect

Example 3: Set link-management

R3000> enable

Password: *****

R3000#

R3000# configure

R3000(config)# set link-management

Primary Interface:

1.Cellular

2.Eth0

3.WiFi

->please select mode(1-3)[1]:2

Secondary Interface:

1.None

2.Cellular

3.WiFi

->please select mode(1-3)[1]:1

//select "Eth0 Only" as wan-link

->ICMP detection primary server[:8.8.8.8

->ICMP detection second server[:8.8.8.4

->ICMP detection interval(3-1800)[30]:

->ICMP detection timeout(1-10)[3]:

->ICMP detection retries(1-20)[3]:

->reset the interface?'yes'or'no'[no]:

this parameter will be take effect when reboot!

really want to modify[yes]:

R3000# write

//save current configuration

Building configuration...

OK

R3000# reload

!Reboot the system ?'yes'or 'no':yes //reload to take effect

Example 4: Set IP address, Gateway and DNS for Eth0

R3000> enable

Password: *****

R3000#

R3000# show link-management

//show current link-management

```
*****
Primary Interface      : Eth0           //now "Eth0" as primary wan-link
Secondary Interface   : None
ICMP primary server   : 8.8.8.8
ICMP second server    : 8.8.4.4
ICMP detection interval : 30 seconds
ICMP detection timeout : 3 seconds
ICMP detection retries : 3
reset the interface   : no
*****
```

```
R3000 # configure
R3000 (config) # set eth0
ethernet interface type: WAN
type select:
  1. Static IP
  2. DHCP
  3. PPPoE
->please select mode (1-3) [1]:
->IP address [192.168.0.1]:58.1.1.1           //set IP address for eth0
->Netmask [255.255.255.0]:255.0.0.0
->gateway [192.168.0.254]:58.1.1.254        //set gateway for eth0
->mtu value (1024-1500)[1500]:
->input primary DNS [192.168.0.254]:58.1.1.254 //set dns for eth0
->input secondary DNS [0.0.0.0]:

this parameter will be take effect when reboot!
really want to modify[yes]:
R3000 (config) # end
R3000# write                               //save current configuration
Building configuration...
OK
R3000 # reload
! Reboot the system? 'yes' or 'no': yes     //reload to take effect
```

Example 5: CLI for Cellular dialup

```
R3000> enable
Password: *****
R3000#
R3000# show link-management
```

```
*****
```

Primary Interface : Cellular //now "Cellular " as wan-link
Secondary Interface : None
ICMP primary server : 8.8.8.8
ICMP second server : 8.8.8.4
ICMP detection interval : 30 seconds
ICMP detection timeout : 3 seconds
ICMP detection retries : 3
reset the interface : no

R3000 (config) # set cellular

- 1. set SIM_1 parameters
- 2. set SIM_2 parameters

->please select mode (1-2)[1]:

SIM 1 parameters:

network provider

- 1. Auto
- 2. Custom
- 3. china-mobile

->please select mode(1-3)[1]:

->dial out using numbers[*99***1#]:

->pin code[]:

connection Mode:

- 1. Always online
- 2. Connect on demand

->please select mode(1-2)[1]:

->redial interval(1-120)[30]:

->max connect try(1-60)[3]:

R3000(config)# end

R3000# write //save current configuration

Building configuration...

OK

R3000# show cellular

Cellular enable : yes

- 1. show SIM_1 parameters
- 2. show SIM_2 parameters

->please select mode(1-2)[1]:

SIM 1 parameters:

```

network provider           : Auto
dial numbers               : *99***1#
pin code                   : NULL
connection Mode           : Always online
redial interval           : 30 seconds
max connect try           : 3
main SIM select           : SIM_1
when connect fail         : yes
when roaming is detected  : no
month date limitation     : no
SIM phone number          :
network select Type       : Auto
authentication type       : AUTO
mtu value                  : 1500
mru value                  : 1500
asynmap value             : 0xffffffff
use peer DNS               : yes
primary DNS                : 0.0.0.0
secondary DNS              : 0.0.0.0
address/control compression: yes
protocol field compression: yes
expert options            : noccp nobsdcomp
    
```

R3000# reload

!Reboot the system ?'yes'or 'no':yes //reload to take effect

5.3 Commands Reference

commands	syntax	description
Debug	Debug <i>parameters</i>	Turn on or turn off debug function
Export	Export <i>parameters</i>	Export vpn ca certificates
Import	Import <i>parameters</i>	Import vpn ca certificates
Syslog	syslog	Export log information to tftp server
Load	Load default	Restores default values
Write	Write	Save current configuration parameters
tftp	Tftp <i>IP-address</i> get { <i>cfg rootfs</i> } <i>file-name</i>	Import configuration file or update firmware via tftp
Show	Show <i>parameters</i>	Show current configuration of each function , if we need to see all please using “show running ”
Set	Set <i>parameters</i>	All the function parameters are set by commands set and add, the difference is that set is for the single parameter and add is for the list parameter
Add	Add <i>parameters</i>	

Glossary

Abbreviations	Description
AC	Alternating Current
APN	Access Point Name of GPRS Service Provider Network
ASCII	American Standard Code for Information Interchange
CE	Conformité Européene (European Conformity)
CHAP	Challenge Handshake Authentication Protocol
CLI	Command Line Interface for batch scripting
CSD	Circuit Switched Data
CTS	Clear to Send
dB	Decibel
dBi	Decibel Relative to an Isotropic radiator
DC	Direct Current
DCD	Data Carrier Detect
DCE	Data Communication Equipment (typically modems)
DCS 1800	Digital Cellular System, also referred to as PCN
DI	Digital Input
DO	Digital Output
DSR	Data Set Ready
DTE	Data Terminal Equipment
DTMF	Dual Tone Multi-frequency
DTR	Data Terminal Ready
EDGE	Enhanced Data rates for Global Evolution of GSM and IS-136
EMC	Electromagnetic Compatibility
EMI	Electro-Magnetic Interference
ESD	Electrostatic Discharges
ETSI	European Telecommunications Standards Institute
EVDO	Evolution-Data Optimized
FDD LTE	Frequency Division Duplexing Long Term Evolution
GND	Ground
GPRS	General Packet Radio Service
GRE	generic route encapsulation
GSM	Global System for Mobile Communications
HSPA	High Speed Packet Access
ID	identification data
IMEI	International Mobile Equipment Identification
IP	Internet Protocol

IPSec	Internet Protocol Security
kbps	kbits per second
L2TP	Layer 2 Tunneling Protocol
LAN	local area network
LED	Light Emitting Diode
M2M	Machine to Machine
MAX	Maximum
Min	Minimum
MO	Mobile Originated
MS	Mobile Station
MT	Mobile Terminated
OpenVPN	Open Virtual Private Network
PAP	Password Authentication Protocol
PC	Personal Computer
PCN	Personal Communications Network, also referred to as DCS 1800
PCS	Personal Communication System, also referred to as GSM 1900
PDU	Protocol Data Unit
PIN	Personal Identity Number
PLCs	Program Logic Control System
PPP	Point-to-point Protocol
PPTP	Point to Point Tunneling Protocol
PSU	Power Supply Unit
PUK	Personal Unblocking Key
R&TTE	Radio and Telecommunication Terminal Equipment
RF	Radio Frequency
RTC	Real Time Clock
RTS	Request to Send
RTU	Remote Terminal Unit
Rx	Receive Direction
SDK	Software Development Kit
SIM	subscriber identification module
SMA antenna	Stubby antenna or Magnet antenna
SMS	Short Message Service
SNMP	Simple Network Management Protocol
TCP/IP	Transmission Control Protocol / Internet Protocol
TE	Terminal Equipment, also referred to as DTE
Tx	Transmit Direction
UART	Universal Asynchronous Receiver-transmitter
UMTS	Universal Mobile Telecommunications System

USB	Universal Serial Bus
USSD	Unstructured Supplementary Service Data
VDC	Volts Direct current
VLAN	Virtual Local Area Network
VPN	Virtual Private Network
VSWR	Voltage Stationary Wave Ratio
WAN	Wide Area Network