

User Guide
6641-22400

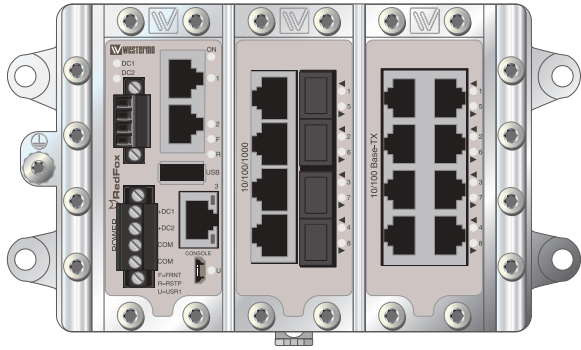

RedFox Industrial

EX - SERIES



Industrial Routing Switch

www.westermo.com





Software tools

Related software tools are available in the folder software tools under technical support on the Westermo website.

Legal information

The contents of this document are provided "as is". Except as required by applicable law, no warranties of any kind, either express or implied, including, but not limited to, the implied warranties of merchantability and fitness for a particular purpose, are made in relation to the accuracy and reliability or contents of this document. Westermo reserves the right to revise this document or withdraw it at any time without prior notice.

Under no circumstances shall Westermo be responsible for any loss of data or income or any special, incidental, and consequential or indirect damages howsoever caused.

More information about Westermo can be found at the following Internet address:

<http://www.westermo.com>

Safety



Before installation:

Read this manual completely and gather all information on the unit. Make sure that you understand it fully. Check that your application does not exceed the safe operating specifications for this unit.

This unit should only be installed by qualified personnel.

This unit should be built-in to an apparatus cabinet, or similar, where access is restricted to service personnel only.

The power supply wiring must be sufficiently fused, and if necessary it must be possible to disconnect manually from the power supply. Ensure compliance to national installation regulations.

This unit uses convection cooling. To avoid obstructing the airflow around the unit, follow the spacing recommendations (see Cooling section).

Before powering-up, a protective earthing conductor must be connected to the protective earthing terminal and have a cross-sectional area of at least 1.5 mm².



Before mounting, using or removing this unit:

Prevent access to hazardous voltage by disconnecting the unit from power supply. Warning! Do not open connected unit. Hazardous voltage may occur within this unit when connected to power supply.



Class 1 Laser Product

Do not look directly into fibre optical fibre port or any connected fibre although this unit is designed to meet the Class 1 Laser regulations.

Care recommendations

Follow the care recommendations below to maintain full operation of unit and to fulfil the warranty obligations.

This unit must not be operating with removed covers or lids.

Do not attempt to disassemble the unit. There are no user serviceable parts inside.

Do not drop, knock or shake the unit, rough handling above the specification may cause damage to internal circuit boards.

Do not use harsh chemicals, cleaning solvents or strong detergents to clean the unit.

Do not paint the unit. Paint can clog the unit and prevent proper operation.

Do not expose the unit to any kind of liquids (rain, beverages, etc). The unit is not waterproof. Keep the unit within the specified humidity levels.

Do not use or store the unit in dusty, dirty areas, connectors as well as other mechanical part may be damaged.

If the unit is not working properly, contact the place of purchase, nearest Westermo distributor office or Westermo Tech support.

Fibre connectors are supplied with plugs to avoid contamination inside the optical port.

As soon as no optical fibre is mounted on the connector, e.g. for storage, service or transportation, the plug should be applied.

Warning:

When this unit is operated at an ambient temperature above 60 °C, the External Surface of Equipment may exceed Touch Temperature Limit according to UL/IEC/EN 60950-1.

To reduce the risk of fire, use on No. 26 AWG or larger telecommunication line cord.



ATEX certification number

Baseefa15ATEX0093X

Standards

EN 60079-0:2012, EN 60079-15:2010, EN 60079-28: 2007

Certification code

RFI-211-T3G, RFI-219-T3G: Ex nA IIC T4 Gc ($-40^{\circ}\text{C} \leq \text{Ta} \leq +70^{\circ}\text{C}$)

all other models: Ex nA [op is T4] IIC T3 Gc ($-40^{\circ}\text{C} \leq \text{Ta} \leq +70^{\circ}\text{C}$)

ATEX code

 II 3G

Specific Conditions of Use

The equipment must be installed in an area of not more than pollution degree 2 in accordance with EN 60664-1, and in an enclosure that provides a minimum degree of protection of at least IP54 and complies with the relevant requirements of EN 60079-0 and EN 60079-15.

All external connections to the equipment and, where applicable, the SFP modules must not be inserted or removed unless either the area in which the equipment is installed is known to be non-hazardous, or the circuits connected have been de-energized.

The network cables once installed must be properly fixated by the use of cable ties or similar to reduce the risk of accidently withdrawing the plugs.

Equipment input parameters

Power Connector: +DC1, +DC2 & –COM

Working Voltage Range = 20 V to 48 VDC.

I/O Connector: 'Status +' & 'Status –' and 'Digital in +' and 'Digital in –'

Maximum I/P Voltage = 60 VDC.



SFP option approved transceivers



SFP Transceivers, 100 Mbit	
1100-0131	MLC2, Multimode, LC-Connector, 2 km, 1310 nm
1100-0132	SLC20, Singlemode, LC-Connector, 20 km, 1310 nm
1100-0133	SLC40, Singlemode, LC-Connector, 40 km, 1310 nm
1100-0134	SLC80, Singlemode, LC-Connector, 80 km, 1550 nm
1100-0140	SLC120, Singlemode, LC-Connector, 120 km, 1550 nm
BiDi Transceivers, 100 Mbit	
1100-0145	SLC15-BiDi-A, Singlemode, BiDi, 20 km, 1310 nm TX, 1550 nm RX
1100-0146	SLC15-BiDi-B, Singlemode, BiDi, 20 km, 1550 nm TX, 1310 nm RX
1100-0152	MLC2-BiDi-A, Multimode, BiDi, 2 km, 1310 nm TX, 1550 nm RX
1100-0153	MLC2-BiDi-B, Multimode, BiDi, 2 km, 1550 nm TX, 1310 nm RX
DDM SFP Transceivers, 100 Mbit	
1100-0531	MLC2-DDM, Multimode, DDM, 2 km, 1310 nm
1100-0532	SLC20-DDM, Multimode, DDM, 20 km, 1310 nm
1100-0533	SLC40-DDM, Multimode, DDM, 40 km, 1310 nm
DDM SFP Transceivers, 1 Gbit	
1100-0542	GSLC50-DDM, Singlemode, DDM, 50 km, 1550 nm
1100-0547	GMLC2-DDM, Multimode, DDM, 2 km, 1310 nm
SFP Transceivers, 1 Gbit	
1100-0144	GMLC550-SX, Multimode, LC-Connector, 550 m, 850 nm, SX
1100-0147	GMLC2-SX+, Multimode, LC-Connector, 2 km, 1310 nm, SX+
1100-0141	GSLC10-LX, Singlemode, LC-Connector, 10 km, 1310 nm, LX
1100-0142	GSLC50-XD, Singlemode, LC-Connector, 50 km, 1550 nm, XD
1100-0143	GSLC80-ZX, Singlemode, LC-Connector, 80 km, 1550 nm, ZX
1100-0171	GSLC110-EZX, Singlemode, LC-Connector, 110 km, 1550 nm, EZX
BiDi Transceiver, 1 Gbit	
1100-0156	GSLC20-BiDi-A, Singlemode, BiDi, 20 km, 1310 nm TX, 1490 nm RX
1100-0157	GSLC20-BiDi-B, Singlemode, BiDi, 20 km, 1490 nm TX, 1310 nm RX
Copper Transceiver, 1 Gbit	
1100-0148	GC100, Copper, RJ45, 100 m, 1000BaseT



ATEX-Zulassungsnummer

Baseefa15ATEX0093X

Standards

EN 60079-0:2012, EN 60079-15:2010, EN 60079-28:2007

Zertifizierungscode

RFI-211-T3G, RFI-219-T3G: Ex nA IIC T4 Gc ($-40^{\circ}\text{C} \leq T_a \leq +70^{\circ}\text{C}$)

alle anderen Modelle: Ex nA [op is T4] IIC T3 Gc ($-40^{\circ}\text{C} \leq T_a \leq +70^{\circ}\text{C}$)

ATEX-Code

 II 3G

Spezifische Einsatzbedingungen

Die Geräte müssen in einem Bereich welcher einem maximalen Verschmutzungsgrad der Stufe 2 gemäß EN 60664-1 entspricht und in einem Gehäuse, das einen Schutzgrad von mindestens IP54 bietet und die relevanten Anforderungen von EN 60079-0 und EN 60079-15 erfüllt, installiert werden.

Alle äußeren Anschlüsse des Gerätes und auch die SFP-Module dürfen nur dann verbunden oder getrennt werden, wenn entweder der Bereich, in dem das Gerät installiert ist, nachweislich ungefährlich ist, oder die verbundenen Stromkreise spannungsfrei sind.

Die Netzkabel müssen nach der Installation mithilfe von Kabelbindern oder ähnlichem Material ordnungsgemäß befestigt werden, um ein versehentliches Abziehen der Stecker zu verhindern.

Eingangsparameter der Geräte

Stromversorgung: +DC1, +DC2 & -COM

Betriebsspannungsbereich = 20 V to 48 VDC.

I/O-Anschluss: 'Status +' & 'Status -' und 'Digital in +' und 'Digital in -'

Maximale I/P-Spannung = 60 VDC.



Für SFP-Option zugelassene Transceiver



SFP-Transceiver, 100 Mbit	
1100-0131	MLC2, Multimode, LC-Anschluss, 2 km, 1310 nm
1100-0132	SLC20, Singlemode, LC-Anschluss, 20 km, 1310 nm
1100-0133	SLC40, Singlemode, LC-Anschluss, 40 km, 1310 nm
1100-0134	SLC80, Singlemode, LC-Anschluss, 80 km, 1550 nm
1100-0140	SLC120, Singlemode, LC-Anschluss, 120 km, 1550 nm
BiDi-Transceiver, 100 Mbit	
1100-0145	SLC15-BiDi-A, Singlemode, BiDi, 20 km, 1310 nm TX, 1550 nm RX
1100-0146	SLC15-BiDi-B, Singlemode, BiDi, 20 km, 1550 nm TX, 1310 nm RX
1100-0152	MLC2-BiDi-A, Multimode, BiDi, 2 km, 1310 nm TX, 1550 nm RX
1100-0153	MLC2-BiDi-B, Multimode, BiDi, 2 km, 1550 nm TX, 1310 nm RX
DDM SFP-Transceiver, 100 Mbit	
1100-0531	MLC2-DDM, Multimode, DDM, 2 km, 1310 nm
1100-0532	SLC20-DDM, Multimode, DDM, 20 km, 1310 nm
1100-0533	SLC40-DDM, Multimode, DDM, 40 km, 1310 nm
DDM SFP-Transceiver, 1 Gbit	
1100-0542	GSLC50-DDM, Singlemode, DDM, 50 km, 1550 nm
1100-0547	GMLC2-DDM, Multimode, DDM, 2 km, 1310 nm
SFP-Transceiver, 1 Gbit	
1100-0144	GMLC550-SX, Multimode, LC-Anschluss, 550 m, 850 nm, SX
1100-0147	GMLC2-SX+, Multimode, LC-Anschluss, 2 km, 1310 nm, SX+
1100-0141	GSLC10-LX, Singlemode, LC-Anschluss, 10 km, 1310 nm, LX
1100-0142	GSLC50-XD, Singlemode, LC-Anschluss, 50 km, 1550 nm, XD
1100-0143	GSLC80-ZX, Singlemode, LC-Anschluss, 80 km, 1550 nm, ZX
1100-0171	GSLC110-EZX, Singlemode, LC-Anschluss, 110 km, 1550 nm, EZX
BiDi-Transceiver, 1 Gbit	
1100-0156	GSLC20-BiDi-A, Singlemode, BiDi, 20 km, 1310 nm TX, 1490 nm RX
1100-0157	GSLC20-BiDi-B, Singlemode, BiDi, 20 km, 1490 nm TX, 1310 nm RX
Kupfer-Transceiver, 1 Gbit	
1100-0148	GC100, Kupfer, RJ45, 100 m, 1000BaseT



Certification ATEX



Numéro de certification ATEX

Baseefa15ATEX0093X

Normes

EN 60079-0:2012, EN 60079-15:2010, EN 60079-28:2007

Code de certification

RFI-211-T3G, RFI-219-T3G: Ex nA IIC T4 Gc ($-40^{\circ}\text{C} \leq T_a \leq +70^{\circ}\text{C}$)

tous les autres modèles: Ex nA [op is T4] IIC T3 Gc ($-40^{\circ}\text{C} \leq T_a \leq +70^{\circ}\text{C}$)

Code ATEX

 II 3G

Conditions spéciales d'utilisation

L'équipement doit être installé dans une zone où le degré de pollution ne dépasse pas le degré 2 conformément à l'EN 60664-1, et dans un boîtier qui fournit un niveau de protection au moins égal à IP54 et conforme aux exigences applicables à EN 60079-0 et EN 60079-15

Toutes les connexions externes à l'équipement et, le cas échéant, les modules SFP ne doivent pas être insérés ou retirés sauf si la zone dans laquelle l'équipement est installé est reconnue comme non dangereuse, ou si les circuits raccordés sont hors-tension.

Une fois les câbles réseau installés, ils doivent être correctement fixé grâce à des attaches de câbles ou autre élément semblable afin de réduire le risque de débranchement accidentel.

Paramètres d'entrée des équipements

Connecteur d'alimentation : +DC1, +DC2 & -COM

Double entrée d'alimentation 20 V à 48 VCC

Connecteur E/S : « Statut + » et « Statut - » et « Entrée digitale + » et « Entrée digitale - »

Tension maximale I/P = 60VCC.



Transmetteurs optionnels SFP certifiés



Transmetteurs SFP, 100 Mbit	
1100-0131	MLC2, multimode, connecteur LC, 2 km, 1310 nm
1100-0132	SLC20, monomode, connecteur LC, 20 km, 1310 nm
1100-0133	SLC40, monomode, connecteur LC, 40 km, 1310 nm
1100-0134	SLC80, monomode, connecteur LC, 80 km, 1550 nm
1100-0140	SLC120, monomode, connecteur LC, 120 km, 1550 nm
Transmetteurs Bi-Di, 100 Mbit	
1100-0145	SLC15 Bi-Di A, monomode, Bi-Di, 20 km, 1310 nm TX, 1550 nm, RX
1100-0146	SLC15-Bi-Di-B, monomode, Bi-Di, 20 km, 1550 nm TX, 1310 nm RX
1100-0152	MLC2-BiDi-A, multimode, Bi-Di, 2 km, 1310 nm TX, 1550 nm RX
1100-0153	MLC2-BiDi-B, multimode, Bi-Di, 2 km, 1550 nm TX, 1310 nm RX
Transmetteurs DDM SFP, 100 Mbit	
1100-0531	MLC2-DDM, multimode, DDM, 2 km, 1310 nm
1100-0532	SLC20-DDM, multimode, DDM, 20 km, 1310 nm
1100-0533	SLC40-DDM, multimode, DDM, 40 km, 1310 nm
Transmetteurs DDM SFP, 1 Gbit	
1100-0542	GSLC50-DDM, monomode, DDM, 50 km, 1550 nm
1100-0547	GMLC2-DDM, multimode, DDM, 2 km, 1310 nm
Transmetteurs SFP, 1 Gbit	
1100-0144	GMLC550-SX, multimode, connecteur LC, 550 m, 850 nm, SX
1100-0147	GMLC2-SX+, multimode, connecteur LC, 2 km, 1310 nm, SX+
1100-0141	GSLC10-LX, monomode, connecteur LC, 10 km, 1310 nm, LX
1100-0142	GSLC50-XD, monomode, connecteur LC, 50 km, 1550 nm, XD
1100-0143	SLC80, monomode, connecteur LC, 80 km, 1550 nm, ZX
1100-0171	GSLC110, monomode, connecteur LC, 110 km, 1550 nm, EZX
Transmetteurs Bi-Di, 1 Gbit	
1100-0156	GSLC20-BiDi-A, monomode, Bi-Di, 20 km, 1310 nm TX, 1490 nm RX
1100-0157	GSLC20-BiDi-B, monomode, Bi-Di, 20 km, 1490 nm TX, 1310 nm RX
Transmetteurs cuivre, 1 Gbit	
1100-0148	GC100, cuivre, RJ45, 100 m, 1000BaseT

IECEX certification



IECEX certification number

IECEXBAS15.0066X

Standards

IEC 60079-0:2011, IEC 60079-15:2010, IEC 60079-28: 2006

Certification code

RFI-211-T3G, RFI-219-T3G: Ex nA IIC T4 Gc ($-40^{\circ}\text{C} \leq T_a \leq +70^{\circ}\text{C}$)

all other models: Ex nA [op is T4] IIC T3 Gc ($-40^{\circ}\text{C} \leq T_a \leq +70^{\circ}\text{C}$)

Specific Conditions of Use

The equipment must be installed in an area of not more than pollution degree 2 in accordance with IEC 60664-1, and in an enclosure that provides a minimum degree of protection of at least IP54 and complies with the relevant requirements of IEC 60079-0 and IEC 60079-15.

All external connections to the equipment and, where applicable, the SFP modules must not be inserted or removed unless either the area in which the equipment is installed is known to be non-hazardous, or the circuits connected have been de-energized.

The network cables once installed must be properly fixated by the use of cable ties or similar to reduce the risk of accidently withdrawing the plugs.

Equipment input parameters

Power Connector: +DC1, +DC2 & –COM

Working Voltage Range = 20 V to 48 VDC.

I/O Connector: 'Status +' & 'Status –' and 'Digital in +' and 'Digital in –'

Maximum I/P Voltage = 60 VDC.

SFP option approved transceivers



SFP Transceivers, 100 Mbit	
1100-0131	MLC2, Multimode, LC-Connector, 2 km, 1310 nm
1100-0132	SLC20, Singlemode, LC-Connector, 20 km, 1310 nm
1100-0133	SLC40, Singlemode, LC-Connector, 40 km, 1310 nm
1100-0134	SLC80, Singlemode, LC-Connector, 80 km, 1550 nm
1100-0140	SLC120, Singlemode, LC-Connector, 120 km, 1550 nm
BiDi Transceivers, 100 Mbit	
1100-0145	SLC15-BiDi-A, Singlemode, BiDi, 20 km, 1310 nm TX, 1550 nm RX
1100-0146	SLC15-BiDi-B, Singlemode, BiDi, 20 km, 1550 nm TX, 1310 nm RX
1100-0152	MLC2-BiDi-A, Multimode, BiDi, 2 km, 1310 nm TX, 1550 nm RX
1100-0153	MLC2-BiDi-B, Multimode, BiDi, 2 km, 1550 nm TX, 1310 nm RX
DDM SFP Transceivers, 100 Mbit	
1100-0531	MLC2-DDM, Multimode, DDM, 2 km, 1310 nm
1100-0532	SLC20-DDM, Multimode, DDM, 20 km, 1310 nm
1100-0533	SLC40-DDM, Multimode, DDM, 40 km, 1310 nm
DDM SFP Transceivers, 1 Gbit	
1100-0542	GSLC50-DDM, Singlemode, DDM, 50 km, 1550 nm
1100-0547	GMLC2-DDM, Multimode, DDM, 2 km, 1310 nm
SFP Transceivers, 1 Gbit	
1100-0144	GMLC550-SX, Multimode, LC-Connector, 550 m, 850 nm, SX
1100-0147	GMLC2-SX+, Multimode, LC-Connector, 2 km, 1310 nm, SX+
1100-0141	GSLC10-LX, Singlemode, LC-Connector, 10 km, 1310 nm, LX
1100-0142	GSLC50-XD, Singlemode, LC-Connector, 50 km, 1550 nm, XD
1100-0143	GSLC80-ZX, Singlemode, LC-Connector, 80 km, 1550 nm, ZX
1100-0171	GSLC110-EZX, Singlemode, LC-Connector, 110 km, 1550 nm, EZX
BiDi Transceiver, 1 Gbit	
1100-0156	GSLC20-BiDi-A, Singlemode, BiDi, 20 km, 1310 nm TX, 1490 nm RX
1100-0157	GSLC20-BiDi-B, Singlemode, BiDi, 20 km, 1490 nm TX, 1310 nm RX
Copper Transceiver, 1 Gbit	
1100-0148	GC100, Copper, RJ45, 100 m, 1000BaseT

Note. Fibre Optic Handling

Fibre optic equipment needs special treatment. It is very sensitive to dust and dirt. If the fibre will be disconnected from the unit the protective hood on the transmitter/receiver must be connected. The protective hood must be kept on during transportation. The fibre optic cable must also be handle the same way. If these recommendations are not followed the warranty might be jeopardized.

Cleaning of the optical connectors

In the event of contamination, the optical connectors should only be cleaned by the use of recommended cleaning fluids and correct cleaning equipment.

Recommended cleaning fluids:

- Methyl-, ethyl-, isopropyl- or isobutyl-alcohol
- Hexane
- Naphtha

Maintenance

No maintenance is required, as long as the unit is used as intended within the specified conditions.

Agency approvals and standards compliance

Art.no	Denomination	Type	Approval/compliance	
3641-5100	RFI-219-T3G-EX	EMC	EN 50121-4, Railway applications – Electromagnetic compatibility – Emission and immunity of the signalling and telecommunications apparatus	
3641-5110	RFI-211-T3G-EX		EN 61000-6-1, Electromagnetic compatibility – Immunity for residential environments	
3641-5200	RFI-215-F4G-T3G-EX		EN 61000-6-2, Electromagnetic compatibility – Immunity for industrial environments	
3641-5210	RFI-207-F4G-T3G-EX		EN 61000-6-3, Electromagnetic compatibility – Emission standards for residential, commercial and light-industrial environments	
3641-5300	RFI-219-F4G-T7G-EX		EN 61000-6-4, Electromagnetic compatibility – Emission for industrial environments	
3641-5310	RFI-211-F4G-T7G-EX	Safety	UL/IEC/EN 60950-1, IT equipment	
3641-5320	RFI-219-F4G-T7G-F8-EX		DNV GL rules for classification – Ships and offshore units	
			IECEx	Explosive atmosphere IEC 60079-0, General requirements IEC 60079-15, Equipment protected by type of protection “n” IEC 60079-28, Protection of equipment and transmission systems using optical radiation
			ATEX	Explosive atmosphere EN 60079-0, General requirements EN 60079-15, Equipment protected by type of protection “n” EN 60079-28, Protection of equipment and transmission systems using optical radiation

FCC Part 15.105

Notice:

This equipment has been tested and found to comply with the limits for a Class A digital device, pursuant to Part 15 of the FCC Rules. These limits are designed to provide reasonable protection against harmful interference when the equipment is operated in a commercial environment. This equipment generates, uses, and can radiate radio frequency energy and, if not installed and used in accordance with the instruction manual, may cause harmful interference to radio communications. Operation of this equipment in a residential area is likely to cause harmful interference in which case the user will be required to correct the interference at his own expense.

Corrosive environment

Notice:

This product has been successfully tested in a corrosion test according to *IEC 60068-2-60, method 3*. This means that the product meets the requirements to be placed in an environment classified as *ISA-S71.04 class G3*.

Note! If the product is placed in a corrosive environment, it is important that all unused connector sockets are protected with a suitable plug in order to avoid corrosion attacks on the gold plated pins in connectors.

Safety control drawing

Position	Direction / description	Input / Output values
1	IO / Status +	$U_{in} = 60 \text{ VDC max}$
2	IO / Status -	$I_{in} = 80 \text{ mA max}$
3	IO / Digital in +	$U_{in} = 60 \text{ VDC max}$
4	IO / Digital in -	$I_{in} = 2.9 \text{ mA max}$

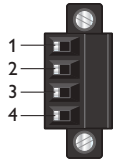

M5 threaded hole for PE connection

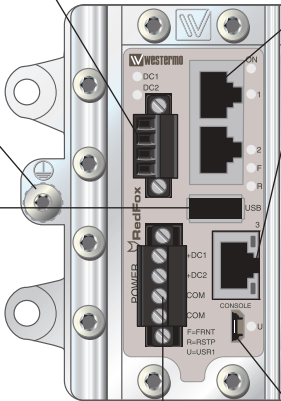

Position	Direction / description	Input/output values
1	In/out / BL_DA+	Per port: $U = \pm 1 \text{ V (4V/us)}$ $I = \pm 20 \text{ mA}$ Data rate: 10/100/1000 Mbit/s
2	In/out / BL_DA-	
3	In/out / BL_DB+	
4	In/out / BL_DC+	
5	In/out / BL_DC-	
6	In/out / BL_DB-	
7	In/out / BL_DD+	
8	In/out / BL_DD-	
Shield	PE	

Galvanically isolated via signal transformers and capacitively isolated to GND/PE through a 2kV 1000pF capacitor.
See user manual for proven transient protection.

Position	Direction / description	Output values
1	Out / VBUS	$U_{out} = 5 \text{ VDC max}$ $I_{out} = 500 \text{ mA max}$
2	In/out / D-	
3	In/out / D+	
4	GND	
Shield	PE	

Position	Direction / description	Input/output values
1	In/Vbus	$U = 5 \text{ VDC max}$ $I = 100 \text{ mA max}$
2	In/Out D-	
3	In/Out D+	
4	Not connected	
5	GND	

Position	Direction / description	Input values
1	In / +DC1	$U_{in} = (16 - 60) \text{ VDC}$ $I_{in} = 2.0 \text{ A @ } 16 \text{ VDC}$ $P_{in} = 31.5 \text{ W @ } 16 \text{ VDC}$
2	In / +DC2	
3	In / COM	
4	In / COM	

Degree of protection:	IP 40
Ambient temperature:	-40 °C to +70 °C.
Installation spacing:	Minimum 25 mm above/below Minimum 10 mm left/right

Safety control drawing

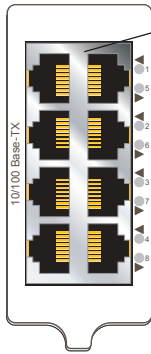

Position	Direction* / description	Input/output values
1	In/out / TD+	Per port: U = ± 1 V (4V/us) I = ± 20 mA Data rate: 10/100 Mbit/s
2	In/out / TD-	
3	In/out / RD+	
4	Not connected	
5	Not connected	
6	In/out / RD-	
7	Not connected	
8	Not connected	
Shield	PE	

Galvanically isolated via signal transformers and capacitively isolated to GND/PE through a 2kV 1000pF capacitor. See user manual for proven transient protection.

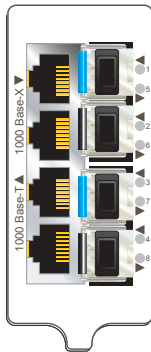

Position	Direction* / description	Input/output values
Rx	In / Receive port	Max 5 dBm
Tx	Out / Transmit port	

Position	Direction* / description	Input/output values
1	In/out / BI_DA+	Per port: U = ± 1 V (4V/us) I = ± 20 mA Data rate: 100/1000 Mbit/s
2	In/out / BI_DA-	
3	In/out / BI_DB+	
4	In/out / BI_DC+	
5	In/out / BI_DC-	
6	In/out / BI_DB-	
7	In/out / BI_DD+	
8	In/out / BI_DD-	
Shield	PE	

Galvanically isolated via signal transformers and capacitively isolated to GND/PE through a 2kV 1000pF capacitor. See user manual for proven transient protection.

* Direction relative this unit!

Declaration of Conformity



Westermo Teleindustri AB

Declaration of Conformity

The manufacturer Westermo Teleindustri AB
SE-640 40 Stora Sundby, Sweden

Herewith declares that the product(s)

Type of product	Models ¹
Industrial Ethernet Switch	RFI-x19-T3G-y, RFI-x03-T3G , RFI-x11-T3G-y, RFI-x15-F4G-T3G-y, RFI-x07-F4G-T3G-y, RFI-x19-F4G-T7G-y, RFI-x11-F4G-T7G-y, RFI-x19-F4G-T7G-F8-y

is in conformity with the following EU directive(s).

No	Short name
2014/30/EU	Electromagnetic Compatibility (EMC)
2014/35/EU	Low Voltage Directive (LVD)
2014/34/EU	Equipment for explosive atmospheres (ATEX)
2011/65/EU	Restriction of the use of certain hazardous substances in electrical and electronic equipment (RoHS)

References of standards applied for this EU declaration of conformity.

No	Title	Issue
EN 50121-4	Railway applications – Electromagnetic compatibility – Emission and immunity of the signalling and telecommunications apparatus	2015
EN 61000-6-1	Electromagnetic compatibility – Immunity for residential environments	2007
EN 61000-6-2	Electromagnetic compatibility – Immunity for industrial environments	2005
EN 61000-6-3	Electromagnetic compatibility – Emission for residential environments	2007 +A1:2011
EN 61000-6-4	Electromagnetic compatibility – Emission for industrial environments	2007 +A1:2011
EN 50581	Technical documentation for the assessment of electrical and electronic products with respect to the restriction of hazardous substances	2012
EN 60950-1	Information technology equipment -- Safety -- General requirements	2006 +A11:2009 +A1: 2010 +A12:2011 +A2: 2013
EN 60079-0 ²	Explosive atmospheres - Equipment - General requirements	2012 +A11: 2013
EN 60079-15 ²	Electrical apparatus for explosive gas atmospheres -Construction, test and marking of type of protection "n" electrical apparatus	2010
EN 60079-28 ²	Explosive atmospheres - Protection of equipment and transmission systems using optical radiation	2007

Signature

Pierre Öberg
Technical Manager
9th March 2017

¹ Model Differences: x = 1 or 2 and indicates Software Class, y = optional and may indicate customer specific models.

² Only valid for y = EX model(s). Certificate: Baseefa15ATEX0093X. Issued by: SGS Baseefa Limited, Rockhead Business Park, Staden Lane, Buxton, Derbyshire, SK17 9RZ, United Kingdom.

Postadress/Postal address	Tel.	Telefax	Postgiro	Bankgiro	Org.nr/ Corp. identity number	Registered office
S-640 40 Stora Sundby	016-428000	016-428001	52 72 79-4	5671-5550	556361-2604	Eskilstuna
Sweden	Int+46 16428000	Int+46 16428001				

Type tests and environmental conditions

Phenomena	Test	Description	Test levels
ESD	EN 61000-4-2	Enclosure contact	± 6 kV
		Enclosure air	± 8 kV
RF field AM modulated	IEC 61000-4-3	Enclosure	20 V/m 80% AM (1 kHz), 80 – 2700 MHz 10 V/m 80% AM (1 kHz), 2700 – 6000 MHz
Fast transient	EN 61000-4-4	Signal ports	± 2 kV
		Power ports	± 2 kV
Surge	EN 61000-4-5	Signal ports	± 2 kV line to earth, ± 1 kV line to line
		Power ports	± 2 kV line to earth, ± 1 kV line to line
RF conducted	EN 61000-4-6	Signal ports	10 V 80% AM (1 kHz), 0.15 – 80 MHz
		Power ports	10 V 80% AM (1 kHz), 0.15 – 80 MHz
Power frequency magnetic field	EN 61000-4-8	Enclosure	300 A/m 0, 16.7, 50, 60 Hz
Pulse magnetic field	EN 61000-4-9	Enclosure	300 A/m
Radiated emission	CISPR 16-2-3	Enclosure	Class B
	ANSI C63.4 (FCC part 15)	Enclosure	Class B, 30 – 6500 MHz
Conducted emission	CISPR 16-2-1	DC power ports Telecommunication ports	Class B
Dielectric strength	EN 60950	Signal port to other isolated ports	1.5 kVrms 50 Hz 1 min
		Power port to other isolated ports	1.5 kVrms 50 Hz 1 min
Temperature	EN 60068-2-1 EN 60068-2-2	Operating	–40 to +70°C (all models)
		Storage & Transport	–40 to +85°C (all models)
		Maximum surface temperature	135 °C (temperature class T4)
Humidity	EN 60068-2-30	Operating	5 to 95% relative humidity
		Storage & Transport	5 to 95% relative humidity
Altitude		Operating	2 000 m / 70 kPa
Service life		Operating	10 years
Vibration	IEC 60068-2-6	Operating	7.5 mm, 5 – 8 Hz 2 g, 8 – 500 Hz (Wall-mounted or DIN-rail mounted using TH 35-15 according to EN 60175)
Shock	IEC 60068-2-27	Operating	15 g, 11 ms (Wall-mounter or DIN-rail mounted using TH 35-15 according to EN 60175)
Enclosure	UL 94	Aluminium / Zink	Flammability class V-0 (all models)

Description

The RedFox Industrial includes a collection of high performance industrial Ethernet switches with enhanced routing functionality designed to build cost effective, secure and reliable networks. The product range offers a number of Ethernet interface combinations, which gives you the ability to select the perfect routing switch for your application providing optimum functionality at the best value.

Advanced routing functions and firewall settings allow the RedFox to segregate networks and ensure that mission critical industrial networks are protected. The RedFox is also able to provide secure remote access to these networks across insecure connections by acting as a VPN endpoint.

RedFox Industrial models

Westermo article number	Denomination	Description
3641-5100	RFI-219-T3G-EX	3 x 10/100/1000 Mbit/s, Ethernet TX, RJ-45 16 x 10/100 Mbit/s, Ethernet TX, RJ-45
3641-5110	RFI-211-T3G-EX	3 x 10/100/1000 Mbit/s, Ethernet TX, RJ-45 8 x 10/100 Mbit/s, Ethernet TX, RJ-45
3641-5200	RFI-215-F4G-T3G-EX	3 x 10/100/1000 Mbit/s, Ethernet TX, RJ-45 8 x 10/100 Mbit/s, Ethernet TX, RJ-45 4 x 100/1000 Mbit/s, pluggable connections transceivers supported, Ethernet FX or TX SFP
3641-5210	RFI-207-F4G-T3G-EX	3 x 10/100/1000 Mbit/s, Ethernet TX, RJ-45. 4 x 100/1000 Mbit/s, pluggable connections transceivers supported, Ethernet FX or TX SFP.
3641-5300	RFI-219-F4G-T7G-EX	7 x 10/100/1000 Mbit/s, Ethernet TX, RJ-45 4 x 100/1000 Mbit/s, pluggable connections transceivers supported, Ethernet FX or TX SFP. 8 x 10/100 Mbit/s, Ethernet TX, RJ-45
3641-5310	RFI-211-F4G-T7G-EX	7 x 10/100/1000 Mbit/s, Ethernet TX, RJ-45 4 x 100/1000 Mbit/s, pluggable connections transceivers supported, Ethernet FX or TX SFP.
3641-5320	RFI-219-F4G-T7G-F8-EX	7 x 10/100/1000 Mbit/s, Ethernet TX, RJ-45 4 x 100/1000 Mbit/s, pluggable connections transceivers supported, Ethernet FX or TX SFP. 8 x 100 Mbit/s, pluggable connections transceivers supported, Ethernet FX or TX SFP.

Housing

Description

Depending on RedFox model, the size of the enclosure may vary. There are two sizes available, a two-slot housing and a three-slot housing.

Regardless of RedFox model, the slot on the far left will always be occupied by the power and CPU interface. Other slots vary depending on RedFox model.

The back end holds a casted DIN-clip for stable mounting on a DIN-rail. Direct wall-mount is also possible using the four brackets in each corner. The back end also holds the earth connection. For detailed ground connection information see section on Earth Connection.

2 and 3 slot enclosure

The slot on the left will always be occupied by the power and CPU. Other slots may vary depending on RedFox model.

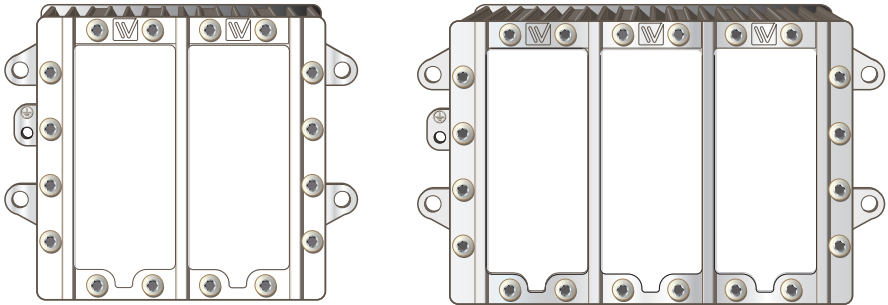

Specification

	2 slot enclosure	3 slot enclosure
Dimension W x H x D	134 x 105 x 122 mm (without connectors)	175 x 105 x 122 mm (without connectors)
Weight	1.5 kg	2.2 kg
Number of slots	2	3
Degree of protection	IP40 according to EN 60529	IP40 according to EN 60529
Cooling	Convection	Convection
Mounting	Horizontal on 35 mm DIN-rail or wall-mounted	Horizontal on 35 mm DIN-rail or wall-mounted

Power and CPU module

Description

Regardless of RedFox model, all units will be delivered with the power and CPU interface in the slot on the far left. The power and CPU module holds a power board and a CPU board. The isolated power supply has redundant power inputs and allows for a wide operating voltage range (see interface specification). The digital IO-port can be used for monitoring the unit (see Westermo OS management guide).

The CPU module holds several interfaces. Three RJ-45 connectors with support for Ethernet 1000BaseTX, a USB port for easy save/load of system configuration and a console port. The console connector is a micro USB cable that connects to a FTDI FT232R USB to serial converter internally. For drivers please see www.ftdichip.com and download the appropriate VCP driver.

For detailed information on LED indicators, see section on LED indicators Power/CPU.

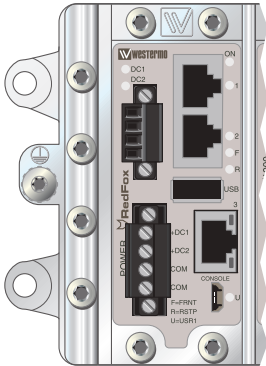

Power and CPU

- ⌘ Redundant power supply and alarm function
- ⌘ Wide operating voltage range (16 VDC to 60 VDC)
- ⌘ Digital IO for monitoring
- ⌘ Console port for management using CLI
- ⌘ USB port for easy save and load system configuration
- ⌘ 3 x RJ-45 Ethernet 1000BaseTX connectors
- ⌘ Status LED's

Interface specifications

Power and CPU	
Rated voltage	20 to 48 VDC
Operating voltage	16 to 60 VDC
Rated frequency	DC
Polarity	Reverse polarity protected
Redundant power input	Yes
Isolation to	All other
Connection	Detachable screw terminal
Connector size	0.2 – 2.5 mm ² (AWG 24 – 12)
Shielded cable	Not required

Power		
Rated voltage		20 to 48 VDC
Operating voltage		16 to 60 VDC
Rated current	RFI-219-T3G-EX	0.63 (0.79*) A @ 20 VDC 0.26 (0.33*) A @ 48 VDC
	RFI-211-T3G-EX	0.43 (0.60*) A @ 20 VDC 0.19 (0.25*) A @ 48 VDC
	RFI-215-F4G-T3G-EX	0.63 (0.82*) A @ 20 VDC 0.26 (0.33*) A @ 48 VDC
	RFI-207-F4G-T3G-EX	0.55 (0.72*) A @ 20 VDC 0.23 (0.29*) A @ 48 VDC
	RFI-219-F4G-T7G-EX	0.93 (1.12*) A @ 20 VDC 0.38 (0.45*) A @ 48 VDC
	RFI-211-F4G-T7G-EX	0.87 (1.06*) A @ 20 VDC 0.35 (0.43*) A @ 48 VDC
	RFI-219-F4G-T7G-F8-EX	1.30 (1.47*) A @ 20 VDC 0.52 (0.58*) A @ 48 VDC
Inrush current		40 mA2s @ 20 VDC 257 mA2s @ 60 VDC
Startup current**		2x Rated current
Rated frequency		DC
Polarity		Reverse polarity protected
Redundant power input		Yes
Isolation to		All other
Connection		Detachable
Connector size		0.2 - 2.5 mm ² (AWG 24 - 12)
Shielded cable		Not required

*With 500mA USB load

** External supply current capability for proper start-up

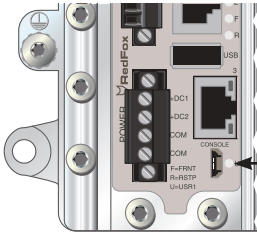

Connection to console port

The console port can be used to connect to the CLI (Command Line Interface). The console connector is a micro USB cable that connects to a FTDI FT232R USB to serial converter internally. For drivers please see www.ftdichip.com and download the appropriate VCP driver.

Console	
Electrical specification	USB 2.0 device interface
Data rate	High speed 480mbit/s
Circuit type	SE LV
Maximum supply current	100 mA
Isolation to	All other except USB
Galvanic connection to	USB
Connection	USB Micro-B connector in device mode

USB	
Electrical specification	USB 2.0 host interface
Data rate	High speed 480mbit/s
Circuit type	SELV
Maximum supply current	500 mA
Isolation to	All other except Console
Connection	USB receptacle connector type A
Conductive housing	Yes

IO / Relay output	
Connect resistance	30 Ω
Isolation to	All other
Connection	Detachable screw terminal
Connector size	0.2 – 2.5 mm ² (AWG 24 – 12)
Maximum voltage/current	60 VDC / 80 mA
IO / Digital input	
Voltage levels	$V_{ih} > 8V$ $V_{il} < 5V$ $I_{in} = 2.9mA @60V$
Isolation to	All other
Connection	Detachable screw terminal
Connector size	0.2 – 2.5 mm ² (AWG 24 – 12)
Maximum voltage	60 VDC

Ethernet TX	
Electrical specification	IEEE std 802.3. 2005 Edition
Data rate	10 Mbit/s, 100 Mbit/s, 1000 Mbit/s, manual or auto
Duplex	Full or half, manual or auto
Circuit type	TNV-1
Transmission range	Up to 150 m with CAT5e cable or better*
Isolation to	All other
Connection	RJ-45 auto MDI/MDI-X
Shielded cable	Not required, except when installed in Railway applications as signalling and telecommunications apparatus and located close to rails*
Conductive housing	Yes
Number of ports	3

* **NOTE!** Railway installation close to the rails.

To minimise the risk of interference, a shielded cable is recommended when the cable is located inside 3 m boundary to the rails and connected to this port.

The cable shield should be properly connected (360°) to an earthing point within 1 m from this port. This earthing point should have a low impedance connection to the conductive enclosure of the apparatus cabinet, or similar, where the unit is built-in. This conductive enclosure should be connected to the earthing system of an installation and may be directly connected to the protective earth. Refer also to "Safety" section.

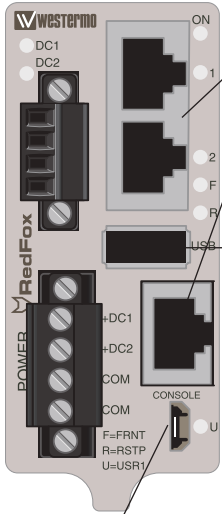

Console
(see more information
on page 13)

Position	Direction	Description
1	In/Out	BI_DA+
2	In/Out	BI_DA-
3	In/Out	BI_DB+
4	In/Out	BI_DC+
5	In/Out	BI_DC-
6	In/Out	BI_DB-
7	In/Out	BI_DD+
8	In/Out	BI_DD-
Shield	In/Out	Connected to PE

Position	Direction*	Description
1	Out	VBUS
2	In/Out	D-
3	In/Out	D+
4	Out	GND
Shield	In/Out	Connected to PE

* Direction relative this unit.

Power connection

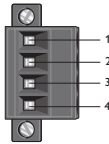
	4-position	Product marking	Direction	Description
	No. 1	+DC1	Input	Supply voltage input DC1
	No. 2	+DC2	Input	Supply voltage input DC2
	No. 3	-COM	Input	Common
	No. 4	-COM	Input	Common

Lynx supports redundant power connection. The positive inputs are +DC1 and +DC2, the negative input for both supplies are -COM. Connect the primary voltage (e.g. +24VDC) to the +DC1 pin and return to one of the -COM pins on the power input.

I/O connection

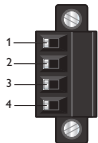
	4-position	Product marking	Direction	Description
	No. 1	Status +	Output	Alarm relay (status) contact
	No. 2	Status -	Output	Alarm relay (status) contact
	No. 3	Digital in +	Input	Digital in +
	No. 4	Digital in -	Input	Digital in -

The Status output is a potential free, opto-isolated normally closed solid-state relay. This can be configured to monitor various alarm events within the Lynx unit, see WeOS Management Guide. An external load in series with an external voltage source is required for proper functionality. For voltage/current ratings, see Interface Specification section.

The Digital in is an opto-isolated digital input which can be used to monitor external events. For voltage/current ratings, see Interface Specification section:

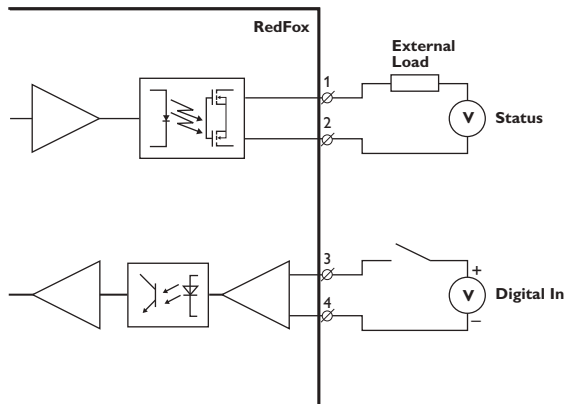

LED indicators Power/CPU

LED	Status	Description
ON	OFF	Unit has no power.
	GREEN	All OK, no alarm condition.
	RED	Alarm condition, or until unit has started up. (Alarm conditions are configurable, see "WeOS Management Guide").
	BLINK	Location indicator ("Here I am!"). Activated when connected to IPConfig Tool, or upon request from Web or CLI.
DC1	OFF	Unit has no power.
	GREEN	Power OK on DC1.
	RED	+DC1 input voltage is below operating voltage limit
DC2	OFF	Unit has no power.
	GREEN	Power OK on DC2.
	RED	+DC2 input voltage is below operating voltage limit
FRNT	OFF	FRNT disabled.
	GREEN	FRNT OK.
	RED	FRNT Error.
	BLINK	Unit configured as FRNT Focal Point.
RSTP	OFF	RSTP disabled.
	GREEN	RSTP enabled.
	BLINK	Unit elected as RSTP/STP root switch.
USR1	<i>Configurable, see WeOS Management Guide</i>	
Copper ports 1-3	OFF	No link.
	GREEN	Link established.
	GREEN FLASH	Data traffic indication.
	YELLOW	Port alarm and no link. Or if FRNT, RSTP or Link Aggregation mode, port is blocked..

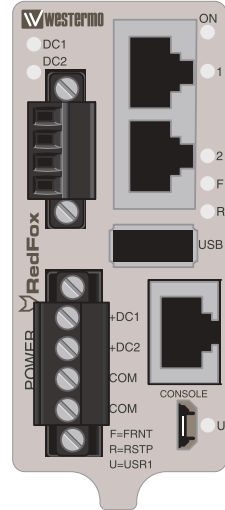

Interface modules

8 copper ports

All ports support category 5e cable or better and can handle cable lengths up to 150 m (492 ft).

Interface specifications

8 copper ports	
Electrical specification	IEEE std 802.3. 2005 Edition
Data rate	10 Mbit/s or 100 Mbit/s, manual or auto
Duplex	Full or half, manual or auto
Circuit type	TNV-1
Transmission range	Up to 150 m with CAT5e cable or better*
Isolation to	All other
Connection	RJ-45 auto MDI/MDI-X
Shielded cable	Not required, except when installed in Railway applications as signalling and telecommunications apparatus and located close to rails*
Conductive housing	Yes
Number of ports	8

* **NOTE!** Railway installation close to the rails.

To minimise the risk of interference, a shielded cable is recommended when the cable is located inside 3 m boundary to the rails and connected to this port.

The cable shield should be properly connected (360°) to an earthing point within 1 m from this port. This earthing point should have a low impedance connection to the conductive enclosure of the apparatus cabinet, or similar, where the unit is built-in. This conductive enclosure should be connected to the earthing system of an installation and may be directly connected to the protective earth. Refer also to "Safety" section.

LED indicators 8 copper ports

LED	Status	Description
Copper ports 1 – 8	OFF	No link.
	GREEN	Link established.
	GREEN FLASH	Data traffic indication.
	YELLOW	Port alarm and no link. Or if FRNT, RSTP or Link Aggregation mode, port is blocked.

Position	Direction*	Description
1	In/Out	TD+
2	In/Out	TD-
3	In/Out	RD+
4	-	Not connected
5	-	Not connected
6	In/Out	RD-
7	-	Not connected
8	-	Not connected
Shield	In/Out	Connected to PE

* Direction relative this unit.

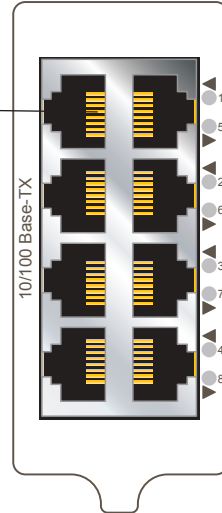

F4G, 4 SFP slots

The F4G interface has four SFP slots supporting Ethernet 10/100/1000BaseFX/X. Each slot can hold one SFP transceiver for copper or fibre cable. For supported transceivers see SFP transceivers user guide (art no. 6100-0000) available at www.westermo.com.

Interface specifications

F4G	
Optical/Electrical specification	IEEE std 802.3. 2005 Edition
Data rate	10, 100 or 1000 Mbit/s*
Duplex	Full or half, manual or auto
Transmission range	Depending on transceiver
Connection	SFP slot holding fibre transceiver or copper transceiver
Number of ports	4

* 100 Mbit/s or 1000 Mbit/s transceiver supported.

F8, 8 SFP slots

The F8 interface has eight SFP slots supporting Ethernet 10/100BaseFX. Each slot can hold one SFP transceiver for copper or fibre cable. For supported transceivers see SFP transceivers user guide (art no. 6100-0000) available at www.westermo.com.

Interface specifications

F8	
Optical/Electrical specification	IEEE std 802.3. 2005 Edition
Data rate	10 or 1000 Mbit/s*
Duplex	Full or half, manual or auto
Transmission range	Depending on transceiver
Connection	SFP slot holding fibre transceiver or copper transceiver
Number of ports	8

* 10 Mbit/s or 100 Mbit/s transceiver supported.

LED indicators F4G

LED	Status	Description
Fibre ports 1 – 4	OFF	No link.
	GREEN	Link established.
	GREEN FLASH	Data traffic indication.
	YELLOW	Port alarm and no link. Or if FRNT, RSTP or Link Aggregation mode, port is blocked.

Position	Direction*	Description
Rx	In	Receive port
Tx	Out	Transmit port

* Direction relative this unit.

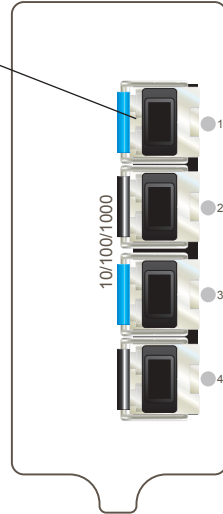

LED indicators F8

LED	Status	Description
Fibre ports 1 – 8	OFF	No link.
	GREEN	Link established.
	GREEN FLASH	Data traffic indication.
	YELLOW	Port alarm and no link. Or if FRNT, RSTP or Link Aggregation mode, port is blocked.

Position	Direction*	Description
Rx	In	Receive port
Tx	Out	Transmit port

* Direction relative this unit.

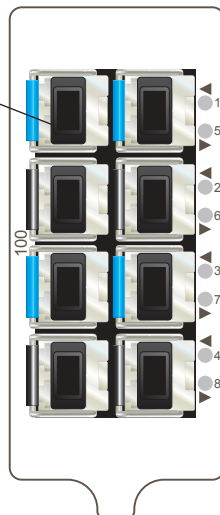

F4G-T4G, 4 SFP slots and 4 Gbit copper ports

The F4G-T4G interface has four SFP slots supporting Ethernet BaseFX/X and four RJ-45 connectors supporting Ethernet 10/100/1000BaseTX/T. Each SFP slot can hold one SFP transceiver for copper or fibre cable. Fibre transceiver distances range from 550 m (0.34 mi) to 120 km (74,6 mi).

For supported transceivers see section on SFP transceivers.

All ports support category 5e cable or better and can handle cable lengths up to 150 m (492 ft).

Interface specifications

F4G-T4G	
Fixed copper ports (RJ-45)	
Electrical specification	IEEE std 802.3. 2005 Edition
Data rate	10, 100 or 1000 Mbit/s
Duplex	Full or half, manual or auto
Circuit type	TNV-1
Transmission range	Up to 150 m with CAT5e cable or better*
Isolation to	All other
Connection	RJ-45 auto MDI/MDI-X
Shielded cable	Not required, except when installed in Railway applications signalling and telecommunications apparatus and located close to rails*
Conductive housing	Yes
Number of ports	4

* **NOTE!** Railway installation close to the rails.

To minimise the risk of interference, a shielded cable is recommended when the cable is located inside 3 m boundary to the rails and connected to this port.

The cable shield should be properly connected (360°) to an earthing point within 1 m from this port. This earthing point should have a low impedance connection to the conductive enclosure of the apparatus cabinet, or similar, where the unit is built-in. This conductive enclosure should be connected to the earthing system of an installation and may be directly connected to the protective earth. Refer also to "Safety" section.

SFP ports	
Optical/Electrical specification	IEEE std 802.3. 2005 Edition
Data rate	10, 100 or 1000 Mbit/s*
Duplex	Full or half, manual or auto
Transmission range	Depending on transceiver
Connection	SFP slot holding fibre transceiver or copper transceiver
Number of ports	4

* 100 Mbit/s or 1000 Mbit/s transceiver supported.

LED indicators F4G-T4G

LED	Status	Description
Copper ports 1 – 4 Fibre ports 5 – 8	OFF	No link.
	GREEN	Link established.
	GREEN FLASH	Data traffic indication.
	YELLOW	Port alarm and no link. Or if FRNT, RSTP or Link Aggregation mode, port is blocked.

Position	Direction*	Description
1	In/Out	BI_DA+
2	In/Out	BI_DA-
3	In/Out	BI_DB+
4	In/Out	BI_DC+
5	In/Out	BI_DC-
6	In/Out	BI_DB-
7	In/Out	BI_DD+
8	In/Out	BI_DD-
Shield	In/Out	Connected to PE

* Direction relative this unit

Position	Direction*	Description
Rx	In	Receive port
Tx	Out	Transmit port

* Direction relative this unit.

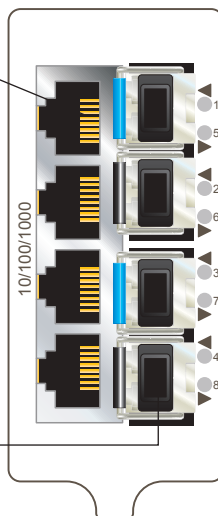

SFP Transceivers

See SFP Transceivers User Guide 6100-0000 for supported SFP transceivers.

Note: The unit supports Westermo labelled transceivers only.

Deviations

With *copper transceiver 1100-0148* the specified operating temperature on the RFI-series is 0 to 50°C.

FRNT reconfiguration times can not be guaranteed with copper transceivers.



Mounting

Mounting, 35 mm DIN-rail

The unit can be mounted on a 35 mm DIN-rail, which is horizontally mounted inside an apparatus cabinet, or similar. Snap on mounting, see figure.

Note! For proper vibration and chock performance Westermo recommends standard top-hat DIN-rail TH 35-15 according to EN 60715.

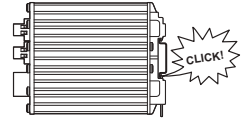
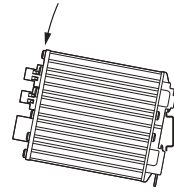

Removal

Press down the support at the back of the unit using a screwdriver. See figure.

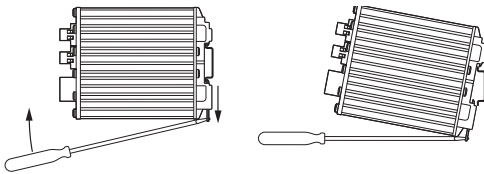

Wall mounting

This unit can also be wall-mounted, see figure.

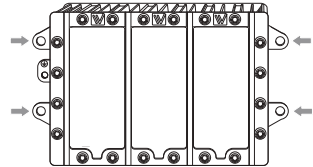

Earth connection

For correct function the ground connection on the unit needs to be properly connected to a solid ground. See figure.

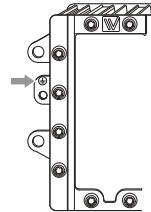

Cooling

This unit uses convection cooling. To avoid obstructing the airflow around the unit, use the following spacing rules. Minimum spacing 25 mm (1.0 inch) above /below and 10 mm (0.4 inches) left /right the unit.

Spacing is recommended for the use of unit in full operating temperature range and service life. See figure.

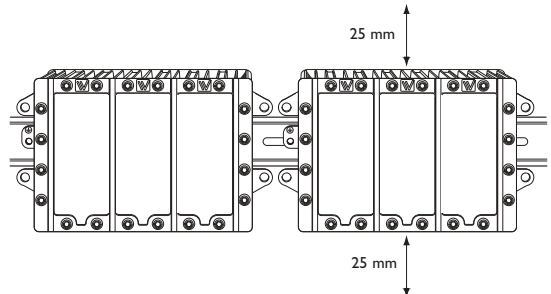

Getting Started

This product runs Westermo Operating System (WeOS) which provides several management tools that can be used for configuration of the unit.

- **WeConfig**
WeConfig is a Network configuration management tool (NCM) made for commissioning and maintenance of components in a network.
- **Web**
Configuration of the unit using the web browser.
- **CLI**
Configuration of the unit via the Command Line Interface.

If the computer is located in the same subnet as the switch you can easily use a web browser to configure the unit. Within the web you can configure most of the available functions.

For advanced network settings and more diagnostic information, please use the CLI. Detailed documentation is available in the chapter "The Command Line Management Tool" in the WeOS management guide.

Factory default	<i>IP address:</i>	192.168.2.200 (and DHCP client)
	<i>Netmask:</i>	255.255.255.0
	<i>Gateway:</i>	Disabled

Note! If you are not sure about the subnet – consult your network administrator.

Configuration

Configure the unit via Webbrowser

The unit can easily be configured via a Web browser.

Open the link <http://192.168.2.200> in your web browser, and you will be prompted with a Login screen, where the default settings for Username and Password are:

Username: admin

Password: westermo

Once you have logged in, you can use the extensive integrated help function describing all configuration options. Two common task when configuring a new switch is to assign appropriate IP settings, and to change the password of the admin account.

The password can be up to 64 characters long, and should consist of printable ASCII characters (ASCII 33-126); 'Space' is not a valid password character.

Referring documents

Type	Description	Document number
Management Guide	Westermo OS management guide	6101-3201

Cable factory reset on RedFox Industrial

It is possible to set the unit to factory default settings by using a standard (straight) Ethernet RJ-45 cable.

1. Power off the switch and disconnect all Ethernet cables (including copper and fibre).
2. Connect an Ethernet cable between Ethernet port 1/1 and Ethernet port 1/2 (that is, connect Ethernet ports 1 and 2 on in the leftmost slot by an Ethernet cable). The ports need to be connected directly by an Ethernet cable, i.e., not via a hub or switch. Use a straight cable - not a cross-over cables - when connecting the ports.
3. Power on the unit.
4. Wait for the unit to start up. Control that the ON LED is flashing red. The ON LED flashing indicates that the unit is now ready to be reset to factory default. You now have the choice to go ahead with the factory reset, or to skip factory reset and boot as normal.
 - Go ahead with factory reset: Acknowledge that you wish to conduct the factory reset by unplugging the Ethernet cables. The ON LED will stop flashing. This initiates the factory reset process, and the unit will restart with factory default settings.
 - Note! Do not power off the unit while the factory reset process is in progress. Skip the factory reset: To skip the factory reset process, just wait for approximately 30 seconds (after the ON LED starts flashing RED) without unplugging the Ethernet cable. The switch will conduct a normal boot with the existing settings.



Westermo • SE-640 40 Stora Sundby, Sweden
Tel +46 16 42 80 00 Fax +46 16 42 80 01
E-mail: info@westermo.com
www.westermo.com

Sales Units

Westermo Data Communications

China

sales.cn@westermo.com
www.cn.westermo.com

France

infos@westermo.fr
www.westermo.fr

Germany

info@westermo.de
www.westermo.de

North America

info@westermo.com
www.westermo.com

Singapore

sales@westermo.com.sg
www.westermo.com

Sweden

info.sverige@westermo.se
www.westermo.se

United Kingdom

sales@westermo.co.uk
www.westermo.co.uk

Other Offices



For complete contact information, please visit our website at www.westermo.com/contact or scan the QR code