



VIDEOJET multi 4000

VJM-4016



BOSCH

en Installation Manual

Table of contents

1	Safety	5
1.1	Electric shock hazard	5
1.2	Installation and operation	5
1.3	Maintenance and repair	6
2	Short information	7
2.1	About this manual	7
2.2	Conventions in this manual	7
2.3	Intended use	7
2.4	EU Directives	7
2.5	Rating plate	7
3	System overview	8
3.1	Parts included	8
3.2	System requirements	8
3.3	Overview of functions	8
3.4	Connections, controls and displays	11
3.4.1	Front view	11
3.4.2	Rear view	12
4	Installation	13
4.1	Preparations	13
4.2	Installing in a switch cabinet	13
5	Connection	15
5.1	Connecting cameras	15
5.2	Establishing the network connection	16
5.3	Connecting audio	17
5.4	Connecting alarm inputs and relay output	18
5.5	Creating a serial connection	19
5.6	Power on/power off	20
6	Configuration	21
6.1	Setup	21
6.2	Setup using Video Client	21
7	Troubleshooting	23
7.1	Contact	23
7.2	General malfunctions	23
7.3	Malfunctions with iSCSI connections	24
7.4	LEDs	24
7.5	Processor load	25
7.6	Network connection	25
7.7	Terminal block	25
7.8	Copyrights	26
8	Maintenance	27
8.1	Updates	27
8.2	Factory reset	27
8.3	Repairs	27
9	Decommissioning	28
9.1	Transfer	28
9.2	Disposal	28

10	Technical data	29
10.1	Electrical	29
10.2	Mechanical	29
10.3	Environmental conditions	29
10.4	Standards	29

1 Safety

1.1 Electric shock hazard

- Never attempt to connect the unit to any power network other than the type for which it is intended.
- Connect the unit to an earthed mains socket-outlet.
- Never open the housing.
- If a fault occurs, disconnect the unit from the power supply and from all other units.
- Install the unit only in a dry, weather-protected location.
- When installing in a switch cabinet, ensure that the unit has sufficient grounding.
- If safe operation of the unit cannot be ensured, remove it from service and secure it to prevent unauthorized operation. In such cases, have the unit checked by Bosch Security Systems.

Safe operation is no longer possible in the following cases:

- if there is visible damage to the unit or power cables,
- if the unit no longer operates correctly,
- if the unit has been exposed to rain or moisture,
- if foreign bodies have penetrated the unit,
- after long storage under adverse conditions, or
- after exposure to extreme stress in transit.

Viktige sikkerhetsinstruksjoner (Norway only)

Utstyr som er koplet til beskyttelsesjord via nettplugg og/eller via annet jordtilkoplet utstyr – og er tilkoplet et kabel-TV nett, kan forårsake brannfare. For å unngå dette skal det ved tilkopling av utstyret til kabel-TV nettet installeres en galvanisk isolator mellom utstyret og kabel-TV nettet.

Viktiga säkerhetsinstruktioner (Sweden only)

Utrustning som är kopplad till skyddsjord via jordat vägguttag och/eller via annan utrustning och samtidigt är kopplad till kabel-TV nät kan i vissa fall medföra risk för brand. För att undvika detta skall vid anslutning av utrustningen till kabel-TVnät galvanisk isolator finnas mellan utrustningen och kabel-TV nätet.

1.2 Installation and operation

- The relevant electrical engineering regulations and guidelines must be complied with at all times during installation.
- Relevant knowledge of network technology is required to install the unit.
- Before installing or operating the unit, make sure you have read and understood the documentation for the other equipment connected to it, such as cameras. The documentation contains important safety instructions and information about permitted uses.
- Perform only the installation and operation steps described in this manual. Any other actions may lead to personal injury, damage to property or damage to the equipment.

Please ensure the following installation conditions:

- Do not install the unit close to heaters or other heat sources. Avoid locations exposed to direct sunlight.
- Allow sufficient space for running cables.
- Ensure that the unit has adequate ventilation. Bear the total heat output in mind, particularly when installing multiple units in a switch cabinet.

- When making connections, use only the cables supplied or use appropriate cables immune to electromagnetic interference.
- Position and run all cables so that they are protected from damage, and provide adequate cable strain relief where needed.
- When installing in a switch cabinet, ensure that the screw joints are free of tension and subject to as little mechanical stress as possible. Ensure that the unit has sufficient grounding.

1.3 Maintenance and repair

- Never open the housing of the unit. The unit does not contain any user-serviceable parts.
- Ensure that all maintenance or repair work is carried out only by qualified personnel (electrical engineers or network technology specialists). In case of doubt, contact your dealer's technical service center.

2 Short information

2.1 About this manual

This manual is intended for persons responsible for the installation and operation of the VIDEOJET multi 4000 encoder. International, national and any regional electrical engineering regulations must be followed at all times. Relevant knowledge of network technology is required. The manual describes the installation of the unit.

2.2 Conventions in this manual

In this manual, the following symbols and notations are used to draw attention to special situations:

**Warning!**

Use of this signal word and symbol indicates that failure to follow the safety instructions described may endanger persons. It indicates a hazardous situation which, if not avoided, could result in death or serious injury.

**Caution!**

Use of this signal word and symbol indicates that failure to follow the safety instructions described may endanger persons. It indicates a hazardous situation which, if not avoided, could result in minor or moderate injury.

**Notice!**

Use of this signal word and symbol indicates that failure to follow the safety instructions described may cause damage to the unit or other equipment or may lead to data loss.

2.3 Intended use

The VIDEOJET multi 4000 encoder transfers video, audio, and control signals over data networks (Ethernet LAN, Internet). The unit is intended for use with CCTV systems. Various functions can be triggered automatically by incorporating external alarm sensors. Other applications are not permitted.

In the event of questions concerning the use of the unit which are not answered in this manual, please contact your sales partner or:

Bosch Sicherheitssysteme GmbH

Robert-Bosch-Ring 5

85630 Grasbrunn

Germany

www.boschsecurity.com

2.4 EU Directives

The VIDEOJET multi 4000 encoder complies with the requirements of EU Directives 89/336 (Electromagnetic Compatibility) and 73/23, amended by 93/68 (Low Voltage Directive).

2.5 Rating plate

For exact identification, the model name and serial number are inscribed on the bottom of the housing. Please make a note of this information before installation, if necessary, so as to have it to hand in case of questions or when ordering spare parts.

3 System overview

3.1 Parts included

- 1 VIDEOJET multi 4000 video encoder
- 1 accessory bag
- 1 Installation Manual
- optional: 1 power cord (depending on the ordered product package)



Notice!

Check that the delivery is complete and in perfect condition. Arrange for the unit to be checked by Bosch Security Systems if you find any damage.

3.2 System requirements

General requirements

- Computer with Windows XP or Windows 7 operating system
- Network access (Intranet or Internet)
- Screen resolution at least 1,024 × 768 pixels
- 16- or 32-bit color depth
- Installed Oracle JVM

Note:

The Web browser must be configured to enable cookies to be set from the IP address of the unit.

In Windows 7, deactivate protected mode on the **Security** tab under **Internet Options**.

You can find notes on using Microsoft Internet Explorer in the online Help in Internet Explorer.

Additional configuration and operational requirements

You find the information on additional configuration and operational requirements in the **Releaseletter** document for the respective firmware.

For the latest version of the firmware, required programs and controls, and the current version of the Video Client management software, access your Bosch product catalog on the Internet.

3.3 Overview of functions

Network video server

The VIDEOJET multi 4000 encoder is a compact network video server for 16 connected video sources. It is primarily designed for encoding video, audio and control data for transfer over an IP network. With its encoding in the H.264 format, the unit is ideally suited for making existing analog CCTV cameras IP-compatible and for remote access to digital VCRs and multiplexers. The use of existing networks means that integration with CCTV systems or local networks can be achieved quickly and easily.

Video images from a single sender can be received simultaneously on multiple receivers. Audio signals can also be transmitted from and to compatible units.

Dual Streaming

The encoder uses the feature Dual Streaming to generate two independent IP video streams per channel, both at full 4CIF resolution and with full frame rate.

Video encoding

The VIDEOJET multi 4000 High Profile encoder uses the H.264 video compression standard. Thanks to efficient encoding, the data rate remains low even with high image quality and can also be adapted to local conditions within wide limits.

Audio encoding

The VIDEOJET multi 4000 encoder uses the G.711, AAC, and L16 audio compression standards. G.711 is the default setting for live transmission. For recording the default setting is AAC. When configuring with a Web browser, you can select your preferred standard for recording. Using video management systems, this is also true for live audio.

Viewing

View the encoder video on a PC using a Web browser, in Bosch Video Management System, or integrate it into another video management system. By routing the IP video to a high-performance VIDEOJET decoder or to Monitor Wall, you can present the video with ultimate clarity.

Recording

You can record each video input independently on different media. Thus video can be recorded centrally on iSCSI drives managed by VRM.

The encoder features a highly flexible recording scheduler, providing up to ten programmable recording profiles and allowing individually assigned camera profiles. With these profiles, you can accelerate the frame rate as well as increase the quality on alarm, saving recording space during non-alarm periods.

Multicast

In suitably configured networks, the multicast function enables simultaneous real-time video transmission to multiple receivers. The UDP and IGMP V2 protocols must be implemented on the network for this function.

Access security

The encoder offers various security levels for accessing the network, the unit, and the data channels. As well as password protection with up to three levels, they support 802.1x authentication using a RADIUS server for identification. You can secure Web browser access by HTTPS using an SSL certificate that is stored in the unit. For total data protection, each communication channel—video, audio, or serial I/O—can be independently AES encrypted.

Remote control

For remote control of external units such as pan or tilt heads for cameras or motorized zoom lenses, control data is transmitted via the encoder's bidirectional serial interface. This interface can also be used to transmit transparent data.

Intelligence

The encoder comes with built-in MOTION+ video motion detection. This motion detection algorithm is based on pixel change and includes object size filtering capabilities.

On alarm, the device can send an e-mail with JPEG images attached.

ONVIF conformance

Conformance to ONVIF 1.02 and ONVIF Profile S provides interoperability between network video products regardless of manufacturer. In addition, the firmware of the device supports all applicable features of the ONVIF 2.2 specification.

ONVIF conformant devices are able to exchange live video, audio, metadata, and control information and ensure that they are automatically discovered and connected to network applications such as video management systems.

Summary

The VIDEOJET multi 4000 encoder provides the following main functions:

- Video, audio, and data transmission over IP data networks
- Dual Streaming function for the encoder for simultaneous encoding with two individually definable profiles
- Multicast function for simultaneous image transmission to multiple receivers
- 16 analog BNC composite video inputs (PAL/NTSC)
- Video encoding according to international standard H.264
- Deinterlacing at video input and progressive encoding
- Integrated Ethernet port (10/100/1000 Base-T)
- Network-attached iSCSI recording
- Transparent, bidirectional data channel via RS-232/RS-422/RS-485 serial interface
- Configuration and remote control of all internal functions via TCP/IP, also secured via HTTPS
- Password protection to prevent unauthorized connection or configuration changes
- 4 alarm inputs for external sensors (such as door contacts)
- 1 relay output for switching external units (such as lamps or sirens)
- Built-in video sensor for motion alarms
- Event-controlled automatic connection
- Convenient maintenance via uploads
- Flexible encryption of control and data channels
- Authentication according to international standard 802.1x
- Bidirectional audio (mono) for line connections
- Audio encoding according to international standards AAC, G.711, and L16

3.4 Connections, controls and displays

3.4.1 Front view

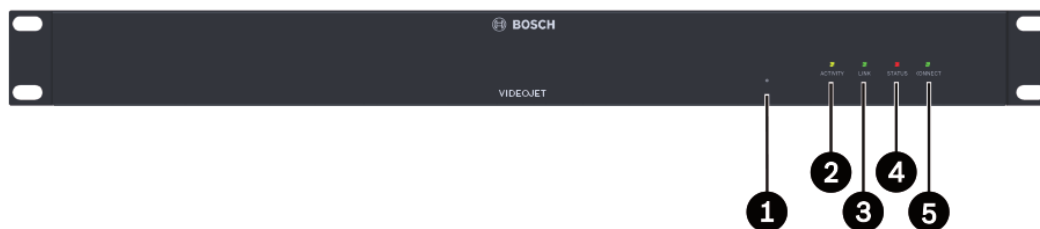

- 1** Factory reset button
to restore factory default settings
- 2** LED **ACTIVITY**
flashes during data transmission
- 3** LED **LINK**
lights up when the unit is connected to the network
- 4** LED **STATUS**
lights up during startup
- 5** LED **CONNECT**
lights up when supplied with power after startup

See also

- LEDs, page 24

3.4.2 Rear view

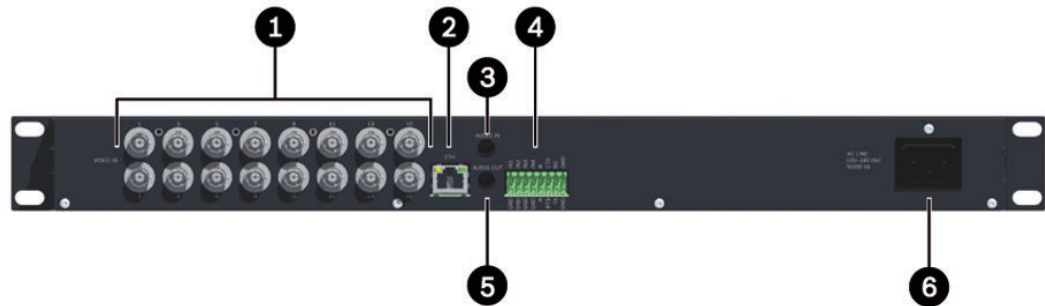

- 1 VIDEO IN 1 to VIDEO IN 16** video inputs
BNC socket for connecting the video source
- 2 ETH** RJ45 socket
for connecting to an Ethernet LAN (local network), 10/100/1000 MBit Base-T
- 3 AUDIO IN** audio connection (mono)
3.5 mm (1/8 in) stereo socket audio in for connecting two audio sources
- 4** Terminal block
for alarm inputs, relay output and serial interface
- 5 AUDIO OUT** audio connection (mono)
3.5 mm (1/8 in) stereo socket line-out for connecting one audio connection
- 6** Power supply input
for connecting the power cable

See also

- *LEDs, page 24*
- *Terminal block, page 25*

4 Installation

4.1 Preparations

The VIDEOJET multi 4000 encoder is designed for installation in a switch cabinet. Mounting the unit in a 19-inch rack using the installation material supplied is a quick and easy operation. Please ensure the following installation conditions:

- Do not install the unit close to heaters or other heat sources. Avoid locations exposed to direct sunlight.
- Allow sufficient space for running cables.
- Ensure that the unit has adequate ventilation. Bear the total heat output in mind, particularly when installing multiple units in a switch cabinet.
- When making connections, use only the cables supplied or use appropriate cables immune to electromagnetic interference.
- Position and run all cables so that they are protected from damage, and provide adequate cable strain relief where needed.

4.2 Installing in a switch cabinet

Notice!



When installing in a switch cabinet, ensure that there is sufficient ventilation for the unit.

There must be at least 5 cm (1.97 in) of free space to the left and right of the unit and at least 10 cm (3.94 in) at the rear.

The unit generates heat during operation. During installation, please note the maximum heat value of 79 BTU/h.

When mounting additional units, direct contact with the encoder is permitted, provided that the surface temperature of the adjacent units does not exceed +50 °C (+122 °F).

When installing in a switch cabinet, ensure that the screw joints are free of tension and subject to as little mechanical stress as possible. Ensure that the unit has sufficient grounding.

1. Prepare the switch cabinet in such a manner that you are easily able to insert the unit directly at the installation point.
2. Place the cage nuts in the corresponding drillings or spaces in the switch cabinet frame.
3. Lift the unit into the switch cabinet frame and insert the fastening screws together with the washers.
4. Tighten the screws one after the other and then check once more that all the screws are tight.

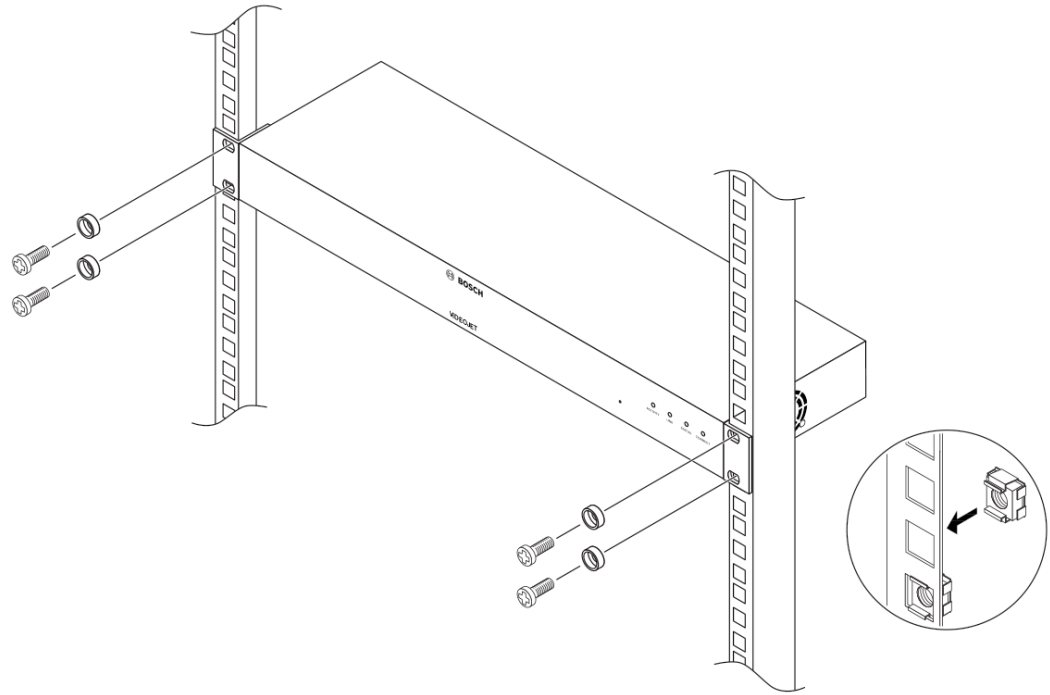

5 Connection

5.1 Connecting cameras

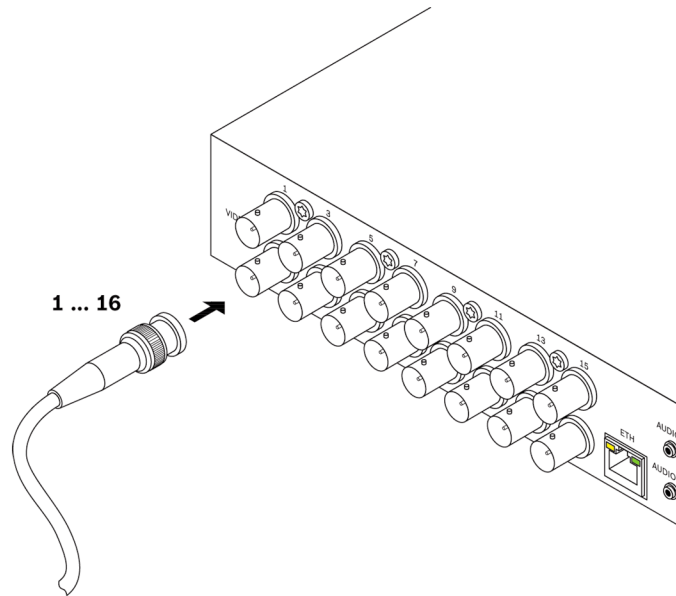

You can connect a maximum of 16 video sources to the VIDEOJET multi 4000 encoder. Any cameras and other video sources that produce a standard PAL or NTSC signal are suitable.

- ▶ Connect each of the cameras or other video sources to BNC sockets **VIDEO IN 1** to **VIDEO IN 16** using a video cable (75 ohm, BNC plug).

Note that termination is always on.

5.2 Establishing the network connection

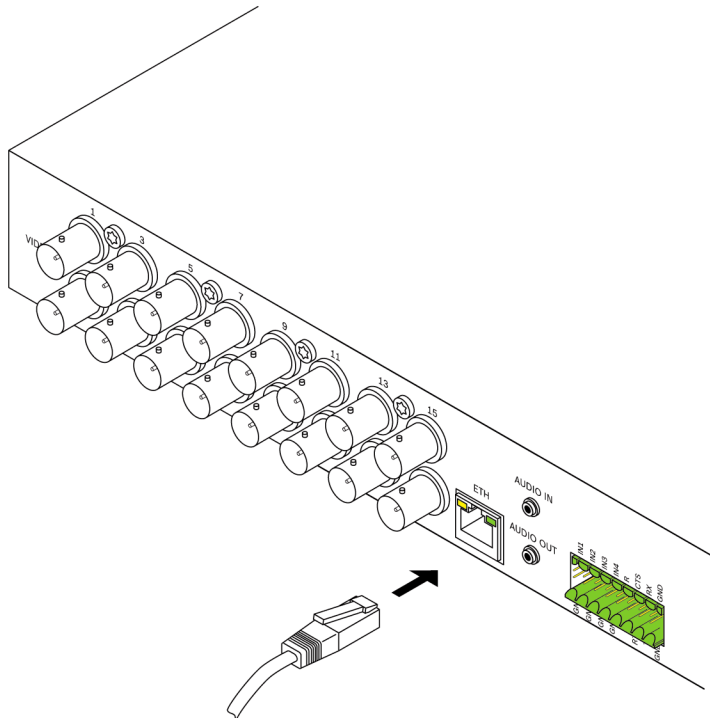

You can connect the unit to a 10/100/1000 Base-T network using a standard UTP category 5 cable with RJ45 plugs.

- ▶ Connect the unit to the network via the **ETH** socket.

5.3 Connecting audio

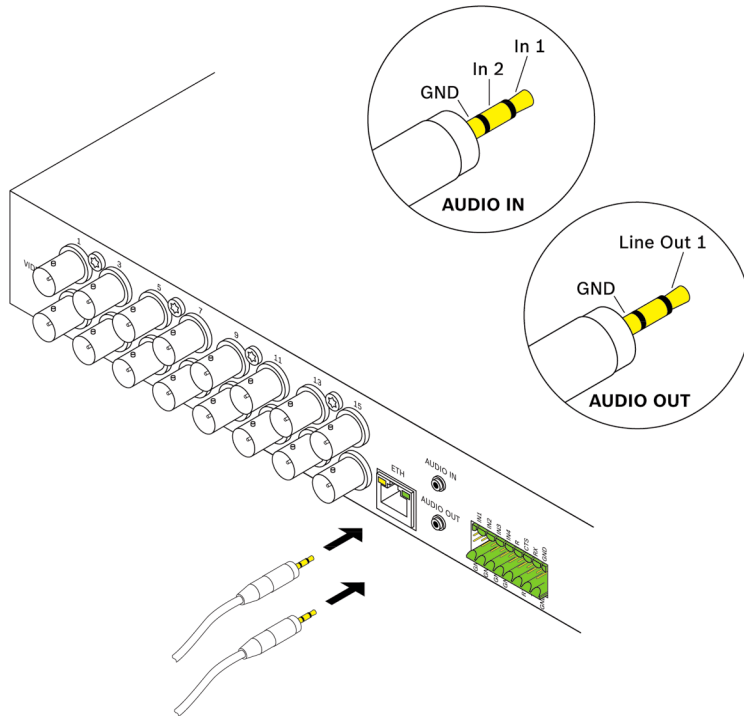

The unit has two audio ports for audio line signals. The audio signals are transmitted two-way and in sync with the video signals. The following specifications should be complied with in all cases.

2 × audio in:	Impedance 9 kohm typ., 5.5 V _{p-p} max. input voltage; microphone amplifier 60 dB max.
1 × line out:	3.0 V _{p-p} typ. output voltage at 10 kohm impedance

The stereo plug must be connected as follows:

Contact	AUDIO IN	AUDIO OUT
Tip	Channel 1	Channel 1
Middle ring	Channel 2	—
Lower ring	Ground	Ground

1. Connect an audio source to the **AUDIO IN** socket with a 3.5 mm (1/8 in) stereo plug.
2. Connect an audio receiver with line-in connection to the **AUDIO OUT** socket with a 3.5 mm (1/8 in) stereo plug.

Note that the audio function is not activated by default. To use audio connections activate the corresponding setting when configuring the unit.

5.4 Connecting alarm inputs and relay output

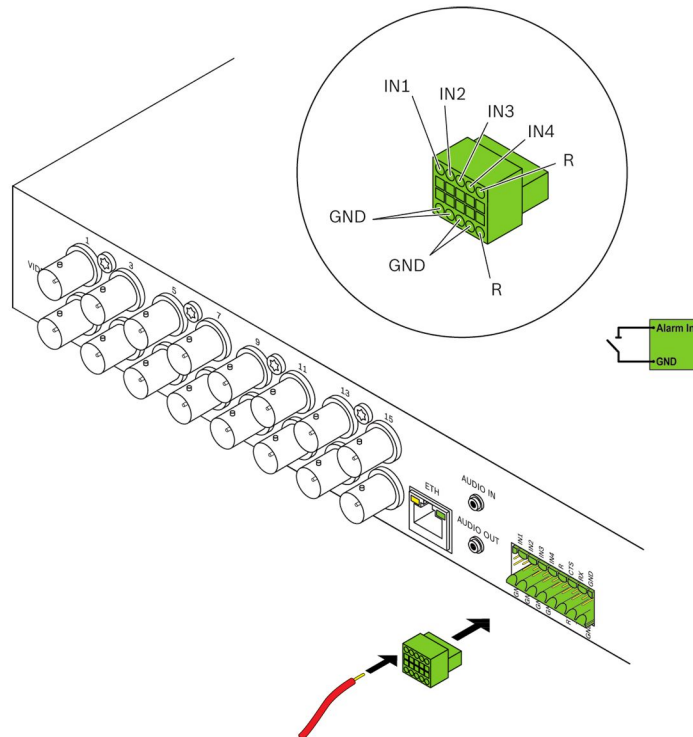

Notice!

For correct connection of alarm inputs and relay outputs, observe the labelling on the unit.

Alarm inputs

The unit has 4 alarm inputs on the terminal block. The alarm inputs are used to connect to external alarm devices such as door contacts or sensors. With the appropriate configuration, an alarm sensor can automatically connect the unit to a remote location, for example. A zero potential closing contact or switch can be used as the actuator. If possible, use a bounce-free contact system as the actuator.

1. Connect the lines to the appropriate terminals on the terminal block (**IN1** to **IN4**) and check that the connections are secure.
2. Connect each alarm input to a ground contact (**GND**).

Relay output

The unit has one relay output for switching external units such as lamps or alarm sirens. You can operate the relay output manually while there is an active connection to the unit. The output can also be configured to automatically activate sirens or other alarm units in response to an alarm signal. The relay output is also located on the terminal block.



Notice!

A maximum load of 30 V_{p-p} (SELV) and 200 mA may be applied to the relay contacts.

1. Connect the lines to the appropriate terminals **R** on the terminal block and check that the connections are secure.

2. Connect the terminal block to the socket on the unit observing the labeling.

See also

- *Terminal block, page 25*

5.5 Creating a serial connection

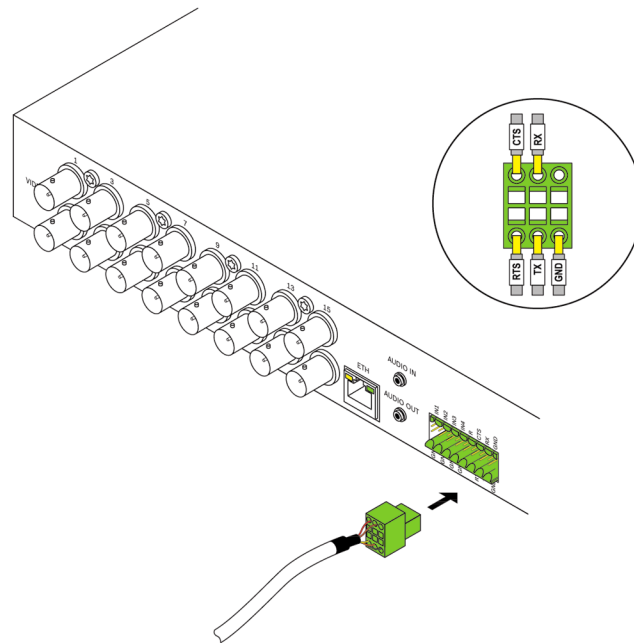

Notice!

For correct connection, observe the labelling on the unit.

The bidirectional data interface is used to control units connected to the VIDEOJET multi 4000 encoder, such as a dome camera with a motorized lens. The connection supports the RS-232, RS-422, and RS-485 transmission standards. A video connection is necessary to transmit transparent data.

The serial interface is also located on the terminal block.

The range of controllable equipment is expanding constantly. The manufacturers of the relevant equipment provide specific information on installation and control. Please take note of the appropriate documentation when installing and operating the peripheral to be controlled. The documentation contains important safety instructions and information about permitted uses.

1. If you require a serial connection to the unit, connect the relevant cables to the terminal block and check that the connections are secure.
2. Connect the terminal block to the socket on the unit observing the labeling.

See also

- *Terminal block, page 25*

5.6 Power on/power off

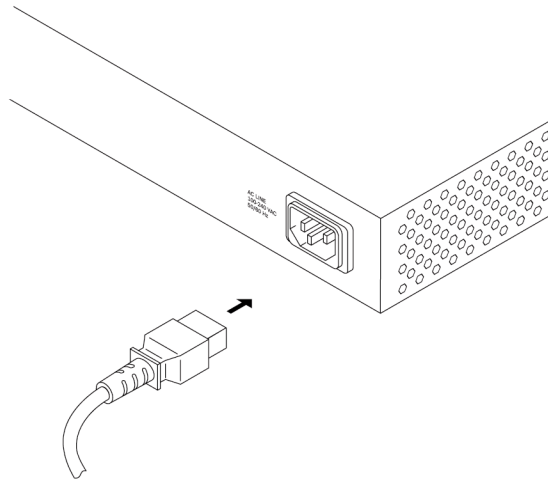

Depending on the ordered product package, the unit is delivered together with a power cord.



Notice!

Use only a suitable power cord. Where necessary, use suitable facilities to ensure that the power supply is free of interference such as voltage surges, spikes or brownouts. Connect the unit to an earthed mains socket-outlet.

Do not connect the unit to the power supply until all other connections have been made.

1. Make sure to use a suitable power cord and connect it to the unit.
2. Plug the power cord into the mains. The unit is ready for use as soon as the **CONNECT** LED lights up.

Provided the network connection has been correctly made, the **LINK** LED also lights up. The flashing LED **ACTIVITY** signals traffic on the network.

See also

- *LEDs, page 24*

6 Configuration

6.1 Setup

Before you can operate the unit within your network, it must have a valid IP address for your network and a compatible subnet mask.

Note:

As a default DHCP is enabled in the unit's network settings. With an active DHCP server in the network you must know the IP address assigned by the DHCP server to operate the unit.

The following default address is preset at the factory: 192.168.0.1

The setup procedure is carried out via our Video Client software or other management systems. All information regarding the configuration can be found in the relevant documentation of the video management system in use.

6.2 Setup using Video Client

For the current version of our Video Client management software, access your Bosch product catalog on the Internet. This program allows you to implement and set up the unit in the network quickly and conveniently.



Installing the program

1. Download Video Client from the Bosch product catalog on the Internet.
2. Unzip the file.
3. Double-click the installer file.
4. Follow the instructions on the screen to complete the installation.

Configuring the unit

You can start Video Client immediately after installation.



1. Double-click the  icon on the desktop to start the program. Alternatively, start the application via the **Start** button and the **Programs** menu (path: Start/Programs/Bosch Video Client/Bosch Video Client).
2. When the program is started for the first time, a wizard opens to help you detect and configure devices on the network.
3. If the wizard does not start automatically, click  to open the Configuration Manager application. Then, click **Configuration Wizard...** on the **Tools** menu.
4. Follow the instructions given in the **Configuration Wizard** window.



Additional parameters

You can check and set additional parameters with the assistance of the Configuration Manager application in Video Client. You can find detailed information on this in the documentation for these applications.

Note that the audio function is not activated by default. To use audio connections activate the corresponding setting when configuring the unit.

7 Troubleshooting

7.1 Contact

If you are unable to resolve a malfunction, please contact your supplier or systems integrator, or go directly to Bosch Security Systems Customer Service.

The following tables are intended to help you identify the causes of malfunctions and correct them where possible.

7.2 General malfunctions

Malfunction	Possible causes	Recommended solution
No image transmission to remote station.	Camera error.	Connect local monitor to the camera and check the camera function.
	Faulty cable connections.	Check all cables, plugs, contacts and connections.
	PAL camera connected after booting.	Reboot the unit.
No connection established, no image transmission.	The unit's configuration.	Check all configuration parameters.
	Faulty installation.	Check all cables, plugs, contacts and connections.
	Wrong IP address.	Check the IP addresses.
	Faulty data transmission within the LAN.	Check the data transmission with e.g. ping .
	The maximum number of connections has been reached.	Wait until there is a free connection and then call the unit again.
No audio transmission to remote station.	Hardware fault.	Check that all connected audio units are operating correctly.
	Faulty cable connections.	Check all cables, plugs, contacts and connections.
	Incorrect configuration.	Check audio parameters.
	The audio connection is already in use by another receiver.	Wait until the connection is free and then call the unit again.
The unit does not report an alarm.	Alarm source is not selected.	Check alarm source settings.
	No alarm response specified.	Specify the desired alarm response, change the IP address, if necessary.

Malfunction	Possible causes	Recommended solution
Control of cameras or other units is not possible.	The cable connection between the serial interface and the connected unit is not correct.	Check all cable connections and ensure all plugs are properly fitted.
	The interface parameters do not match those of the other unit connected.	Make sure that the settings of all units involved are compatible.
The unit is not operational after a firmware upload.	Power failure during programming by firmware file.	Have the unit checked by Customer Service and replace it, if necessary.
	Incorrect firmware file.	Enter the IP address of the unit followed by /main.htm in your Web browser and repeat the upload.
Placeholder with a red cross instead of the ActiveX components.	JVM not installed on your computer or not activated.	Install Oracle JVM from the Bosch product catalog on the Internet.
Web browser contains empty fields.	Active proxy server in network.	Create a rule in the local computer's proxy settings to exclude local IP addresses.

7.3

Malfunctions with iSCSI connections

Malfunction	Possible causes	Recommended solution
After connecting to the iSCSI target, no LUNs are displayed.	Incorrect LUN mapping during iSCSI system configuration.	Check the iSCSI system configuration and reconnect.
After connecting to the iSCSI target, "LUN FAIL" appears below a node.	The LUN list could not be read, as it was assigned to the wrong network interface.	Check the iSCSI system configuration and reconnect.
LUN mapping is not possible.	Some iSCSI systems do not support the use of an initiator extension.	Delete the initiator extension.

7.4

LEDs

The unit has LEDs on its front and rear panels that show the operating status and can give indications of possible malfunctions:

ACTIVITY LED

Flashes: Traffic on the network.

LINK LED

Lights up: Network connection established.

STATUS LED

Lights up:	Startup in progress.
Flashes:	The unit is faulty, for example following failed firmware upload.

CONNECT LED

Lights up:	The unit is switched on and startup completed.
Flashes:	Video connection active.

RJ45 socket LEDs

Left LED flashes (as ACTIVITY LED):	Traffic on the network.
Right LED lights up (as LINK LED):	Network connection established.

7.5 Processor load

If the unit is accessed via the Web browser, you will see the processor load indicator bar in the top right of the window next to the information icon .



You can obtain additional information to help you when troubleshooting or fine tuning the unit. The values indicate the proportions of the individual functions on the coder load, shown as percentages.

- ▶ Move the cursor over the graphic indicator. Some additional numerical values are also displayed.

7.6 Network connection



You can display information about the network connection. To do this, move the cursor over .

Link	Ethernet link type
UL	Uplink, speed of the outgoing data traffic
DL	Downlink, speed of the incoming data traffic

7.7 Terminal block

The terminal block has several contacts for:

- Serial data transmission
- 4 alarm inputs
- 1 relay output

Pin assignment serial interface

Options for using the serial interface include transferring transparent data, controlling connected units or operating the unit with a terminal program.

The serial interface supports the RS-232, RS-422 and RS-485 transmission standards. The mode used depends on the current configuration.

The pin assignment of the serial interface depends on the interface mode used:

Contact	RS-232 mode	RS-422 mode	RS-485 mode
CTS	—	RxD- (receive data minus)	—
TXD	TxD (transmit data)	TxD- (transmit data minus)	Data-
RTS	—	TxD+ (transmit data plus)	Data+
RXD	RxD (receive data)	RxD+ (receive data plus)	—
GND	GND (ground)	—	—

Pin assignment I/O

Contact	Function
IN1	Input alarm 1
IN2	Input alarm 2
IN3	Input alarm 3
IN4	Input alarm 4
GND	Ground
R	Relay output

Connect each alarm input to a ground contact (**GND**).

7.8

Copyrights

Fonts

The firmware uses the fonts "Adobe-Helvetica-Bold-R-Normal--24-240-75-75-P-138-ISO10646-1" and "Adobe-Helvetica-Bold-R-Normal-12-120-75-75-P-70-ISO10646-1" under the following copyright:

Copyright 1984-1989, 1994 Adobe Systems Incorporated.

Copyright 1988, 1994 Digital Equipment Corporation.

Permission to use, copy, modify, distribute and sell this software and its documentation for any purpose and without fee is hereby granted, provided that the above copyright notices appear in all copies and that both those copyright notices and this permission notice appear in supporting documentation, and that the names of Adobe Systems and Digital Equipment Corporation not be used in advertising or publicity pertaining to distribution of the software without specific, written prior permission.

Software

This software is based in part on the work of the Independent JPEG Group.

Audio

AAC audio technology licensed by Fraunhofer IIS (<http://www.iis.fraunhofer.de/amm/>).

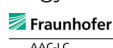

8 Maintenance

8.1 Updates

Firmware updates are carried out via our Video Client software or other management systems in use. Please refer to the relevant documentation.

8.2 Factory reset

You can use the factory reset button to restore the unit to its original settings. Any changes to the settings are overwritten by the factory defaults. A reset may be necessary, for example, if the unit has invalid settings that prevent it from functioning as desired.

1. Using a pointed object, press the factory reset button located on the front panel until the **STATUS** LED flashes. All settings will revert to their defaults.
2. The unit is ready for configuration as soon as the **CONNECT** LED lights up.

See also

- *Configuration, page 21*

8.3 Repairs

- Never open the housing of the unit. The unit does not contain any user-serviceable parts.
- Ensure that all maintenance or repair work is carried out only by qualified personnel (electrical engineers or network technology specialists). In case of doubt, contact your dealer's technical service center.

9 Decommissioning

9.1 Transfer

VIDEOJET multi 4000 should only be passed on together with this installation manual.

9.2 Disposal

Your Bosch product is designed and manufactured with high-quality materials and components which can be recycled and reused.



This symbol means that electrical and electronic equipment, at their end-of-life, should be disposed of separately from your household waste.

In the European Union, there are separate collection systems for used electrical and electronic products. Please dispose of this equipment at your local community waste collection/recycling center.

10 Technical data

10.1 Electrical

Input voltage	100 to 240 V AC, 47 to 63 Hz
Input current	0.32 to 0.15 A
Power consumption	23 W max
Connectors	IEC 320 C14

10.2 Mechanical

Dimensions (H × W × D)	44 × 443 × 157 mm (1.732 × 17.441 × 6.181 in), without brackets including BNC sockets
Weight	Approx. 1.7 kg (3.7 lb)
Video	16 × BNC socket, 75 ohm, terminated Analog composite, 0.7 to 1.2 V _{p-p} , NTSC or PAL
Audio	2 × 3.5 mm (1/8 in) stereo socket (2 × mono in, microphone/line; 1 × mono line out)
Signal line in	9 kohm typical, 5.5 V _{p-p} max, microphone amplifier 60 dB max
Signal line out	3.0 V _{p-p} at 10 kohm typical
Ethernet	10/100/1000 Base-T, auto-sensing, half/full duplex, RJ45
COM port	1 × RS-232/RS-422/RS-485, bidirectional, push-in terminal
Alarm	4 × push-in terminal input (non-isolated closing contact), activation resistance 10 ohm max
Relay	1 × push-in terminal output 30 V _{p-p} (SELV), 200 mA
Display	4 × LED (ACTIVITY, LINK, STATUS, CONNECT) on the front panel 2 × LED (data transfer, network connection) on the rear panel

10.3 Environmental conditions

Operating temperature	0 °C to +50 °C (+32 °F to +122 °F)
Storage temperature	0 °C to +50 °C (+32 °F to +122 °F)
Relative humidity	0 to 95% atmospheric humidity, non-condensing
Thermal value	79 BTU/h max

10.4 Standards

Video standards	PAL, NTSC
Video coding protocols	H.264 High Profile (ISO/IEC 14496-10) M-JPEG
Video data rates	9.6 kbps to 2 Mbps per channel
Connections	Min. 16 simultaneous unicast/multicast
Image resolutions	4CIF 704 × 576/480 (PAL/NTSC)
GOP structure	I, IP

Total delay	260 ms typical
Dual Streaming	Full performance and full frame rate on both streams for every video input channel
Frame rate	1 to 25/30 ips (PAL/NTSC)
Audio standards	G.711, L16, AAC-LC
Audio frequency rate	G.711: 300 Hz to 3.4 kHz L16: 300 Hz to 6.4 kHz AAC-LC: 300 Hz to 6.4 kHz
Audio sampling rate	G.711: 8 kHz L16: 16 kHz AAC-LC: 16 kHz
Audio data rate	G.711: 80 kbps L16: 640 kbps AAC-LC: 48 kbps
Signal-to-noise ratio	> 50 dB
Network protocols	IPv4, IPv6, UDP, TCP, HTTP, HTTPS, RTP/RTCP, IGMP V2/V3, ICMP, ICMPv6, RTSP, FTP, Telnet, ARP, DHCP, SNTP, 802.1x, DNS, DNSv6, DDNS (DynDNS.org, selfHOST.de, no-ip.com), SMTP, iSCSI, UPnP (SSDP), DiffServ (QoS), LLDP, SOAP, Dropbox, CHAP, digest authentication
Encryption	TLS 1.0, SSL, DES, 3DES, AES

Index

A

Alarm, 12
Alarm input, 18
Audio connections, 12, 17

C

Cameras, 15
Closing contact, 18
Conventions, 7

D

Danger, 5
Data interface, 19
Default
 IP address, 21
Default IP address, 21
DHCP, 21
Dome camera, 19
Dual Streaming, 8

E

Electromagnetic compatibility, 7
Encoding, 8

H

Heat value, 13

I

Identification, 7
Installation, 5
Installation conditions, 5, 13
Installation equipment, 13
Installing in a switch cabinet, 13
Interface, 26
IP address
 Default, 21

L

Low Voltage Directive, 7

M

Main functions, 10
Maintenance, 6, 27
Multicast function, 9

N

Network, 16
Network connection, 12, 20, 25

O

Operation, 5
Overview of functions, 8

P

Parameters, 22
Pin assignment, 26
Processor load, 25
Processor load indicator, 25

R

Rear panel connections, 12
Regulations, 7
Relay, 12, 18
Relay outputs, 18
Remote control, 9
Repair, 6, 27
Reset, 11, 27

S

Safety, 5
Screen resolution, 8
Serial interface, 12
Serial number, 7
Signal source, 18
Symbols, 7

T

Transmission standards, 19, 26
Trigger, 18

U

Unit reset, 27

V

Ventilation, 13

Bosch Sicherheitssysteme GmbH

Robert-Bosch-Ring 5

85630 Grasbrunn

Germany

www.boschsecurity.com

© Bosch Sicherheitssysteme GmbH, 2014