

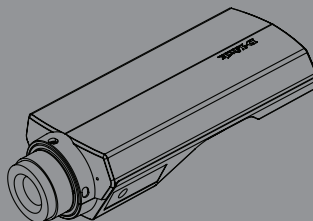

Quick Install Guide HD PoE Network Camera

This document will guide you through the basic installation process for your new D-Link Network Camera.

DCS-3010



Quick Install Guide

Documentation also available
on CD and via the D-Link
Website

DCS-3010 Quick Install Guide

This installation guide provides basic instructions for installing the DCS-3010 Network Camera on your network. For additional information about how to use the camera, please refer to the User Manual which is available on the CD included in this package or from the D-Link support website.

Installation Steps

1. Verify the package contents against the list below.
2. Hardware Overview
3. Hardware Installation
4. Configuration with Wizard

1. Package Contents

- DCS-3010 HD PoE Network Camera
- Camera Stand
- User Manual and Software on CD-ROM
- CAT5 Ethernet Cable
- Power Adapter
- Lens Back Focus Tool
- Allen Wrench
- Quick Install Guide

If any of the above items are missing, please contact your reseller.

2. Hardware Overview

Rear Panel

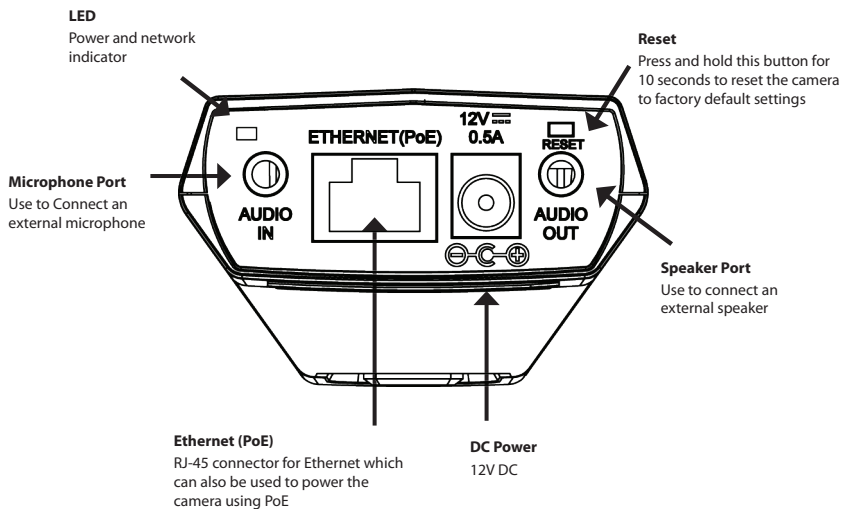

Front Panel

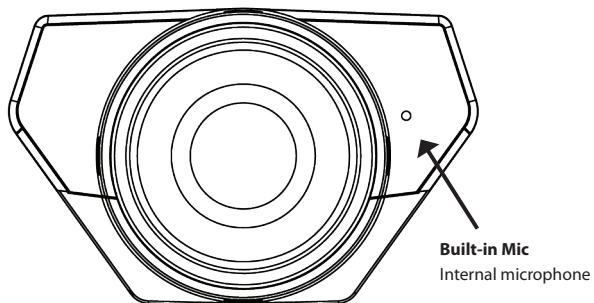

Side Panel

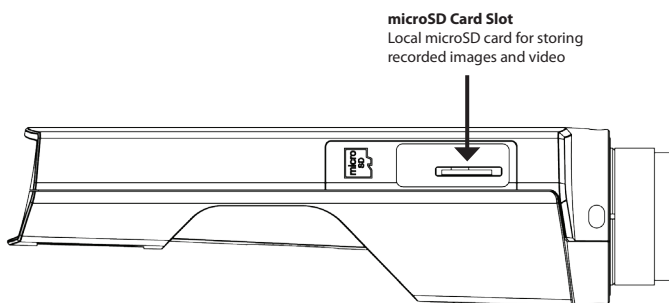

Bottom Panel

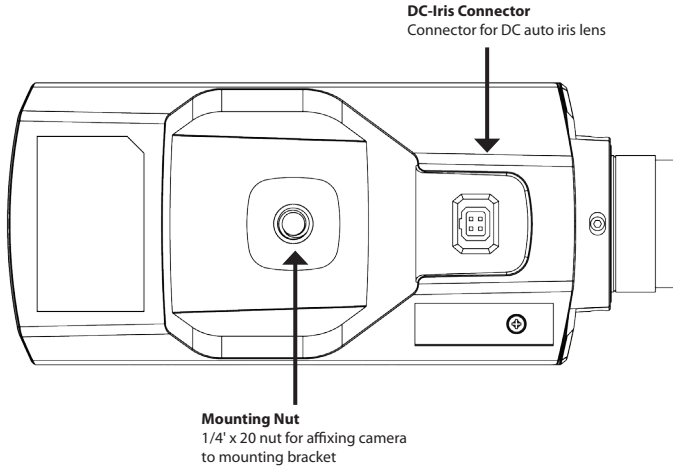

Right Panel

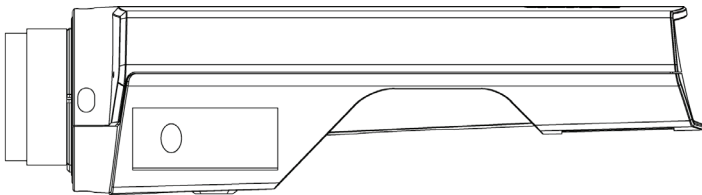

3. Hardware Installation

Basic Connection (without PoE)

Connect the camera to your switch or router via Ethernet cable.

Connect the supplied power cable from the camera to a power outlet.

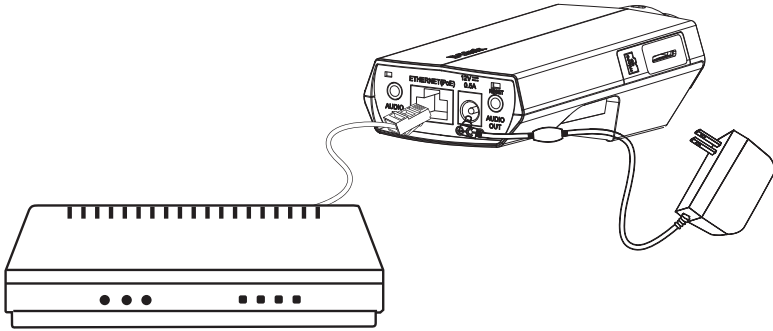

Connection Using a PoE Switch

If using a PoE switch, connect the network camera via Ethernet cable.

PoE will transmit both power and data over a single cable.

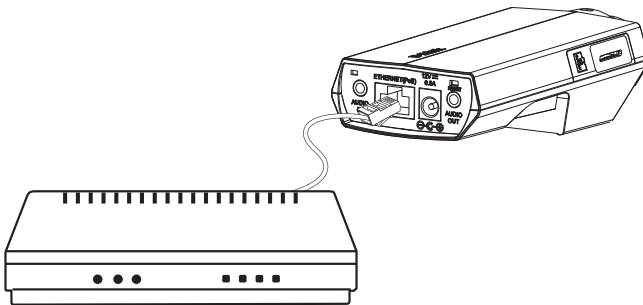

Note: Once power has been established, the LED will turn red. When the device has obtained an IP address and is accessible, the LED will turn green.

4. Configuration with Wizard

Insert the DCS-3010 CD into your computer's CD-ROM drive to begin the installation. If the Autorun function on your computer is disabled, or if the D-Link Launcher fails to start automatically, click **Start > Run**. Type **D:\autorun.exe**, where D: represents the drive letter of your CD-ROM drive.

Click **Setup Wizard** to begin the installation.



After clicking Setup Wizard, the following window will open.

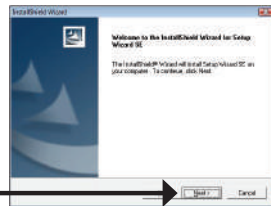

Click **Next** to continue.

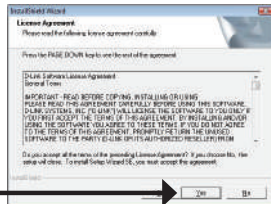

Click **Yes** to accept the License Agreement.

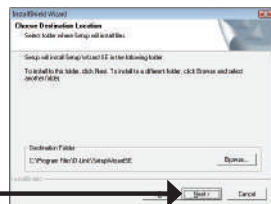

To start the installation process, click **Next**.

Note: The installation may take several minutes to finish.

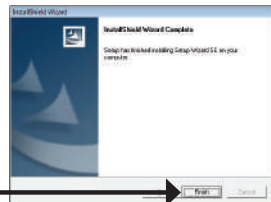

Click **Finish** to complete the installation.

Click on the **D-Link Setup Wizard SE** icon that was created in your Windows Start menu.



Start > D-Link > Setup Wizard SE

The Setup Wizard will appear and display the MAC address and IP address of your camera(s). If you have a DHCP server on your network, a valid IP address will be displayed. If your network does not use a DHCP server, the network camera's default static IP **192.168.0.20** will be displayed.

Click the **Wizard** button to continue.



Enter the Admin ID and password. When logging in for the first time, the default Admin ID is **admin** and leave the password blank.

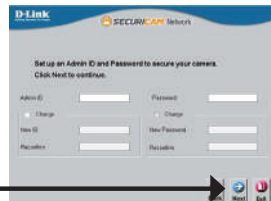

Click **Next** to proceed to the next page.

Select **DHCP** if your camera obtains an IP address automatically when it boots up. Select **Static IP** if the camera will use the same IP address each time it is started.



Click **Next** to proceed to the next page.

Take a moment to confirm your settings and click **Restart**.



Viewing Camera via Web Browser

Click on the **D-Link Setup Wizard SE** icon that was created in your Windows Start menu.

Start > D-Link > Setup Wizard SE



Select the camera and click the button labeled **Link** to access the web configuration.

The Setup Wizard will automatically open your web browser to the IP address of the camera.



Enter **admin** as the default user name and leave the password blank. Click **OK** to continue.

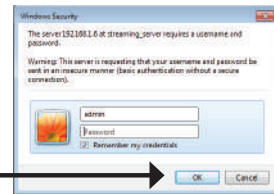

This section shows your camera's live video. You can select your video profile and view or operate the camera. For additional information about web configuration, please refer to the user manual included on the CD-ROM or the D-Link website.

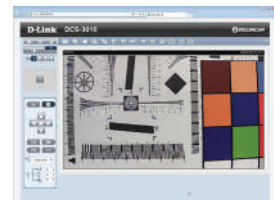

Notes

Notes

ENGLISH

Technical Support

D-Link's website contains the latest user documentation and software updates for D-Link products. U.S. and Canadian customers can contact D-Link Technical Support through our website or by phone.

United States

(877) 354-6555

<http://support.dlink.com>

Canada

(877) 354-6560

<http://support.dlink.ca>

D-Link[®]

Version 1.0
November 2, 2012
a11633L8B001

Copyright ©2012 D-Link Corporation/D-Link Systems, Inc. All rights reserved. D-Link and the D-Link logo are registered trademarks of D-Link Corporation or its subsidiaries in the United States and other countries. Other trademarks are the property of their respective owners. Actual data throughput will vary. Network conditions and environmental factors, including volume of network traffic, building materials and construction, and network overhead lower actual data throughput rate. Product specifications, size and shape are subject to change without notice, and actual product appearance may differ from that depicted on the packaging. Visit www.dlink.com for more details.