

Panasonic[®]

Operating Instructions

Expandable Digital Corded/Cordless
Answering System

Model No. **KX-TG9391**

with 2 Handsets

Model No. **KX-TG9392**

2LINE

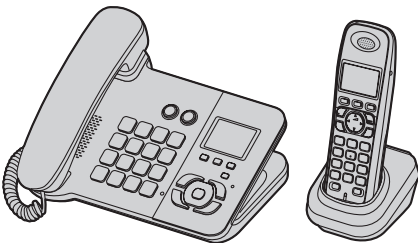

Model shown is KX-TG9391.

DECT
6.0

This unit is compatible with Caller ID. You must subscribe to the appropriate service offered by your service provider/telephone company.

Charge the batteries for about 7 hours before initial use.

Please read these operating instructions before using the unit and save them for future reference.

For assistance, visit our website:

<http://www.panasonic.com/help> for customers in the U.S.A. or Puerto Rico.

Table of Contents

Introduction

Product information	3
Accessory information	4
System capabilities	5
For your safety	6
Important safety instructions	7
For best performance	7

Preparation

Controls	9
Display/Indicators	10
Symbols used in these operating instructions	11
Connections	12
Battery installation and replacement	15
Battery charge	15
Setting up the unit before use	16

Making/Answering Calls

Making calls	18
Answering calls	19
Useful features during a call	20
Using the other line during a call	21

Phonebook

Base unit/handset phonebook	22
Copying phonebook entries	24

Programming

Programmable settings	25
Special instructions for programmable settings	31
Registering a unit	32

Caller ID Service

Using Caller ID service	33
Caller list	33

Answering System

Answering system	36
Turning the answering system on/off	36
Greeting message	36
Listening to messages using the base unit	37
Listening to messages using the handset	38
Remote operation	39
Answering system settings	41

Voice Mail Service

Voice mail service	42
------------------------------	----

Intercom/Locator

Intercom	43
Transferring calls	43
Conference calls	44
Handset locator	45

Useful Information

Wall mounting for charger	46
Belt clip	46
Headset (optional)	46
Error messages	47
Troubleshooting	48
FCC and other information	52
Specifications	55
Customer services	56
Warranty	57

Index

Index	59
-----------------	----

Product information

Thank you for purchasing a Panasonic digital cordless phone.

Notable differences between the models

KX-TG9391 series

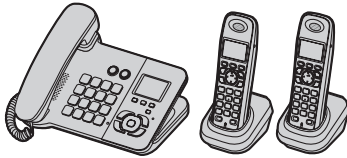

- Model shown is KX-TG9392.

Model No.	Base unit	Handset	
	Part No.	Part No.	Quantity
KX-TG9391 ^{*1}	KX-TG9391	KX-TGA939	1
KX-TG9392	KX-TG9391	KX-TGA939	2

^{*1} Feature differences:

Intercom calls can be made between the handsets by purchasing and registering one or more optional handsets (page 5).

Accessory information

Supplied accessories

No.	Accessory item/Order number	Quantity	
		KX-TG9391	KX-TG9392
①	AC adaptor for base unit ^{*1} /PQLV207T or PQLV219Z	1	1
②	4-wire telephone line cord with green plugs/PQJA10088Z	1	1
③	2-wire telephone line cord with transparent plugs/PQJA10075Z	1	1
④	Corded handset/PNLXP1001Z	1	1
⑤	Corded handset cord/PQJA212V	1	1
⑥	Rechargeable batteries ^{*2}	2	4
⑦	Handset cover ^{*3} /PNYNTGA430BR	1	2
⑧	Belt clip/PNKE1004Z1	1	2
⑨	Charger/PNLC1001YT	1	2
⑩	AC adaptor for charger ^{*1} /PQLV209T or PQLV219Z	1	2

*1 Both of the AC adaptors function well.

*2 See page 4 for replacement battery information.

*3 The handset cover comes attached to the handset.

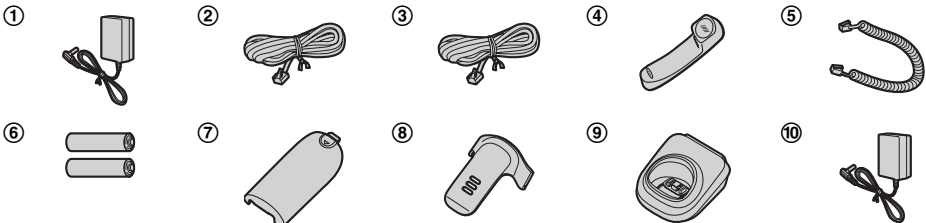

Additional/replacement accessories

Please contact your nearest Panasonic dealer for sales information.

No.	Accessory item	Order number
①	Headset	KX-TCA60, KX-TCA86, KX-TCA92, KX-TCA93, KX-TCA94, KX-TCA95
②	2-line splitter	KX-J42



● Headset shown is KX-TCA86.



Replacement battery information:

- Replace batteries only with a nickel metal hydride (Ni-MH) type of battery. This model requires 2 AAA (R03) batteries for every handset. For best performance, we recommend using Panasonic rechargeable batteries (Order No. HHR-4DPA). To order, please call 1-800-332-5368 or visit <http://www.panasonic.com/batterystore>

Expanding your phone system

You can expand your phone system by registering optional **KX-TGA939** handsets (6 max.) to a single base unit.

Sales and support information

- To order additional/replacement accessories, call 1-800-332-5368.
 - TTY users (hearing or speech impaired users) can call 1-866-605-1277.
-

System capabilities

The unit can accommodate up to 2 external telephone lines and the following operations are available at a time.

How many units can be in use at one time?

■ A maximum of 4 parties are available:

Line 1: Outside call (including 1 extension and 1 outside party)

Line 2: Outside call (including 1 extension and 1 outside party)

Ex. Outside call on line 1

Ex. Outside call on line 2



■ A maximum of 5 parties are available:

Line 1: Conference call (including 2 extensions and 1 outside party)

Line 2: Outside call (including 1 extension and 1 outside party)

Ex. Conference call on line 1

Ex. Outside call on line 2



■ The following operations are possible simultaneously:

- An outside call and 1 pair of intercom call can be made at a time.
- While a caller is leaving a message on your answering system through one line, the unit can make an outside call through another line.

Note:

- The maximum operating number may decrease, depending on the state of usage, for example, when the answering system is taking a call.

For your safety

To prevent severe injury and loss of life/property, read this section carefully before using the product to ensure proper and safe operation of your product.

WARNING

Power connection

- Use only the power source marked on the product.
- Do not overload power outlets and extension cords. This can result in the risk of fire or electric shock.
- Completely insert the AC adaptor/power plug into the power outlet. Failure to do so may cause electric shock and/or excessive heat resulting in a fire.
- Regularly remove any dust, etc. from the AC adaptor/power plug by pulling it from the power outlet, then wiping with a dry cloth. Accumulated dust may cause an insulation defect from moisture, etc. resulting in a fire.
- Unplug the product from power outlets if it emits smoke, an abnormal smell, or makes an unusual noise. These conditions can cause fire or electric shock. Confirm that smoke has stopped emitting and contact the Panasonic Call Center at 1-800-211-PANA (1-800-211-7262).
- Never touch the plug with wet hands. Danger of electric shock exists.

Installation

- To prevent the risk of fire or electrical shock, do not expose the product to rain or any type of moisture.
- Do not place or use this product near automatically controlled devices such as automatic doors and fire alarms. Radio waves emitted from this product may cause such devices to malfunction resulting in an accident.

Operating safeguards

- Unplug the product from power outlets before cleaning. Do not use liquid or aerosol cleaners.
- Do not disassemble the product.
- Do not spill liquids (detergents, cleansers, etc.) onto the telephone line cord plug, or allow it to

become wet at all. This may cause a fire. If the telephone line cord plug becomes wet, immediately pull it from the telephone wall jack, and do not use.

- Do not excessively pull the corded handset cord from the base unit. This may cause the base unit to fall, resulting in injury.

Medical

- Consult the manufacturer of any personal medical devices, such as pacemakers or hearing aids, to determine if they are adequately shielded from external RF (radio frequency) energy. (The product operates in the frequency range of 1.92 GHz to 1.93 GHz, and the RF transmission power is 115 mW (max.))
- Do not use the product in health care facilities if any regulations posted in the area instruct you not to do so. Hospitals or health care facilities may be using equipment that could be sensitive to external RF energy.

CAUTION

Installation and relocation

- Never install telephone wiring during an electrical storm.
- Never install telephone line jacks in wet locations unless the jack is specifically designed for wet locations.
- Never touch uninsulated telephone wires or terminals unless the telephone line has been disconnected at the network interface.
- Use caution when installing or modifying telephone lines.
- The AC adaptor is used as the main disconnect device. Ensure that the AC outlet is installed near the product and is easily accessible.
- The cordless handset is unable to make calls when:
 - the handset batteries need recharging or have failed.
 - there is a power failure.

Battery

- We recommend using the batteries noted on page 4. **USE ONLY rechargeable Ni-MH batteries AAA (R03) size.**
- Do not mix old and new batteries.

- Do not open or mutilate the batteries. Released electrolyte from the batteries is corrosive and may cause burns or injury to the eyes or skin. The electrolyte may be toxic if swallowed.
- Exercise care when handling the batteries. Do not allow conductive materials such as rings, bracelets, or keys to touch the batteries, otherwise a short circuit may cause the batteries and/or the conductive material to overheat and cause burns.
- Charge the batteries provided with or identified for use with this product only, in accordance with the instructions and limitations specified in this manual.
- Only use a compatible charger to charge the batteries. Do not tamper with the charger. Failure to follow these instructions may cause the batteries to swell or explode.
- For maximum coverage and noise-free communications, place your base unit:
 - at a convenient, high, and central location with no obstructions between the cordless handset and base unit in an indoor environment.
 - away from electronic appliances such as TVs, radios, personal computers, wireless devices or other phones.
 - avoid facing radio frequency transmitters, such as external antennas of mobile phone cell stations (avoid putting the base unit on a bay window or near a window).
- Coverage and voice quality depends on the local environmental conditions.
- If the reception for a base unit location is not satisfactory, move the base unit to another location for better reception.

Important safety instructions

When using your product, basic safety precautions should always be followed to reduce the risk of fire, electric shock and injury to persons, including the following:

1. Do not use this product near water for example, near a bathtub, washbowl, kitchen sink or laundry tub, in a wet basement or near a swimming pool.
2. Avoid using a telephone (other than a cordless type) during an electrical storm. There may be a remote risk of electric shock from lightning.
3. Do not use the telephone to report a gas leak in the vicinity of the leak.
4. Use only the power cord and batteries indicated in this manual. Do not dispose of batteries in a fire. They may explode. Check with local codes for possible special disposal instructions.

SAVE THESE INSTRUCTIONS

For best performance

Base unit location/avoiding noise

The base unit and other compatible Panasonic units use radio waves to communicate with each other.

Environment

- Keep the product away from electrical noise generating devices, such as fluorescent lamps and motors.
- The product should be kept free from excessive smoke, dust, high temperature, and vibration.
- The product should not be exposed to direct sunlight.
- Do not place heavy objects on the power cord or top of the product.
- When you leave the product unused for a long period of time, unplug the product from the power outlet.
- The product should be kept away from heat sources such as heaters, kitchen stoves, etc. It should not be placed in rooms where the temperature is less than 5 °C (41 °F) or greater than 40 °C (104 °F). Damp basements should also be avoided.
- The maximum calling distance may be shortened when the product is used in the following places: Near obstacles such as hills, tunnels, underground, near metal objects such as wire fences, etc.
- Operating the product near electrical appliances may cause interference. Move away from the electrical appliances.

Routine care

- **Wipe the outer surface of the product with a soft moist cloth.**

Introduction

- Do not use benzine, thinner, or any abrasive powder.

Notice for product disposal, transfer, or return

- This product can store your private/confidential information. To protect your privacy/confidentiality, we recommend that you erase the information such as phonebook or caller list entries from the memory before you dispose of, transfer, or return the product.

Controls

Base unit

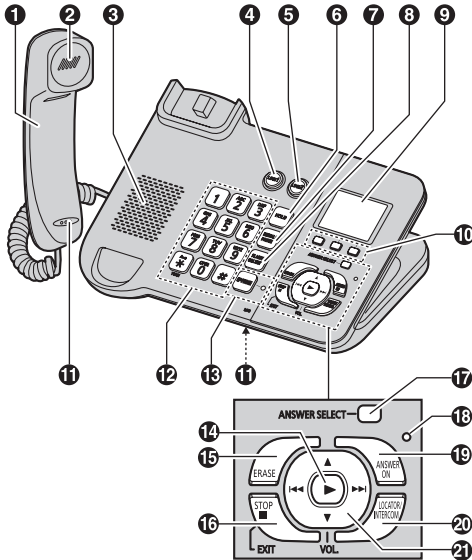

- 1 Coded handset
- 2 Receiver
- 3 Speaker
- 4 [LINE 1]
LINE1 indicator
- 5 [LINE 2]
LINE2 indicator
- 6 [HOLD]
- 7 [REDIAL] [PAUSE]
- 8 [FLASH] [CALL WAIT]
- 9 Display
- 10 Soft keys
- 11 MIC (Microphone)
- 12 Dial keypad
([*]: TONE)
- 13 [SP-PHONE] (Speakerphone)
SP-PHONE indicator
- 14 [▶] (Play)
Message indicator
- 15 [ERASE]
- 16 [■] (STOP) (EXIT)
- 17 [ANSWER SELECT]
- 18 ANSWER ON indicator
- 19 [ANSWER ON]
- 20 [LOCATOR] [INTERCOM]
- 21 Navigator key ([▲]/[▼]/[◀]/[▶])
VOL. (Volume: [▲]/[▼])

- 19 [ANSWER ON]
- 20 [LOCATOR] [INTERCOM]
- 21 Navigator key ([▲]/[▼]/[◀]/[▶])
VOL. (Volume: [▲]/[▼])

Handset

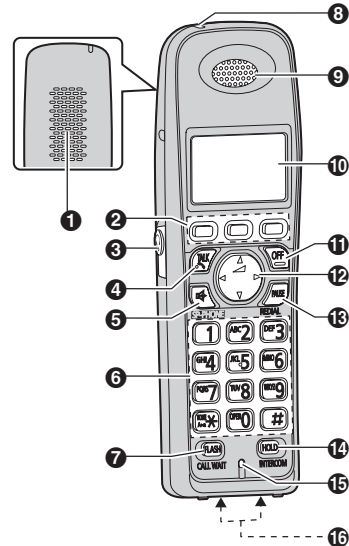

- 1 Speaker
- 2 Soft keys
- 3 Headset jack
- 4 [TALK]
- 5 [SP-PHONE: Speakerphone]
- 6 Dial keypad
([*]: TONE)
- 7 [FLASH] [CALL WAIT]
- 8 Charge indicator
Ringer indicator
- 9 Receiver
- 10 Display
- 11 [OFF]
- 12 Navigator key ([▲]/[▼]/[◀]/[▶])
◀ (Volume: [▲]/[▼])
- 13 [PAUSE] [REDIAL]
- 14 [HOLD] [INTERCOM]
- 15 Microphone
- 16 Charge contacts

Preparation

Using the navigator keys

The navigator keys can be used to navigate through menus and to select items shown on the display by pressing:

Base unit: [▲], [▼], [◀], or [▶]

Handset: [▲], [▼], [◀], or [▶]

To adjust the receiver or speaker volume, press [▲] to increase the volume, or press [▼] to decrease the volume repeatedly while talking.

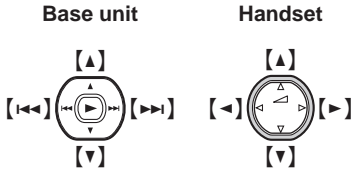

Soft keys

Each unit features 3 soft keys. By pressing a soft key, you can select the feature shown directly above it on the display.

Base unit

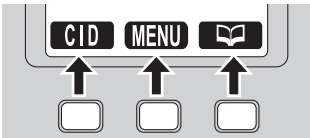

Handset

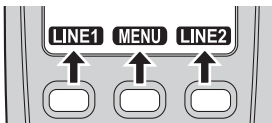

Display/Indicators

Base unit display items

Item	Meaning
LINE1 LINE2	Indicates the selected line(s) for answering system operations and settings.
	Ringer volume (page 29) is off. ^{*1}
	Night mode is on (page 31).
PRIV.	Call privacy mode is on (page 21).

^{*1} Corresponding line number(s) is indicated next to the item.

Handset display items







Item	Meaning
	Battery level
	Within range of the base unit <ul style="list-style-type: none"> When flashing: Handset is searching for the base unit (page 48).
L1 L2	The line is in use. <ul style="list-style-type: none"> When flashing: <ul style="list-style-type: none"> the call is put on hold on that line. the answering system is answering a call on that line. When flashing rapidly: an incoming call is now being received on that line.
	Ringer volume (page 29) is off. ^{*1}
	Speaker is on (page 18).
	Night mode is on (page 31).
	Alarm is on (page 31).
1	Handset number
PRIV.	Call privacy mode is on (page 21).

^{*1} Corresponding line number(s) is indicated next to the item.







Menu icons

When in standby mode, pressing **[MENU]** (middle soft key) reveals the main menu. From here you can access various features and settings.

Base unit menu icons

Menu icon	Menu/feature
	View Caller ID
	Phonebook
	Set answering
	Ringer settings
	Initial settings
	Customer support

Handset menu icons

Menu icon	Menu/feature
	View Caller ID
	Phonebook
	Answering device
	Ringer settings
	Initial settings
	Customer support



LINE1 indicator/LINE2 indicator on the base unit

The LINE1 indicator and LINE2 indicator show the status of each line, respectively, as follows.

Status	Meaning
Light off	The line is available.
Light on	The line is in use.
Flashing rapidly	A call is being received.

Status	Meaning
Flashing	A call is put on hold or the answering system is answering a call.

Symbols used in these operating instructions

Symbol	Meaning
	Perform with the base unit.
	Perform with the handset.
[]	The words in the brackets indicate button names/soft key names on the base unit and handset. Example: Unit keys:  , [OFF] Soft keys: [MENU], [SELECT]
→	Proceed to the next operation.
“ ”	The words in quotations indicate the menu on the display. Example: “Date and time”
[▼]/[▲]: “ ”	Press [▼] or [▲] to select the words in quotations. Example: [▼]/[▲]: “Off”

Connections

Connecting the AC adaptor/corded handset

Connect the AC adaptor cord (❶) by pushing the plug firmly (❷). Connect the corded handset cord (❸) to the corded handset and the base unit.

Base unit

- Use only the supplied Panasonic AC adaptor PQLV207 or PQLV219.

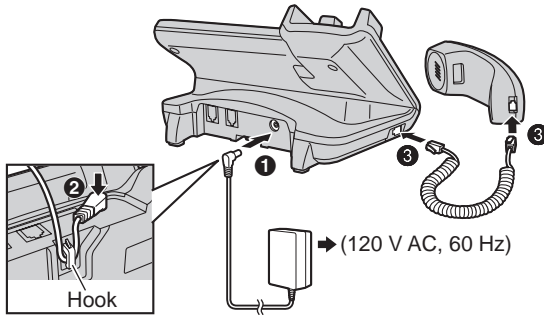

Charger

- Use only the supplied Panasonic AC adaptor PQLV209 or PQLV219.

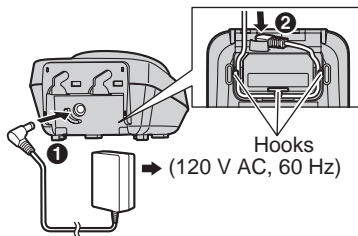

Note:

- The AC adaptor must remain connected at all times. (It is normal for the adaptor to feel warm during use.)
- The AC adaptor should be connected to a vertically oriented or floor-mounted AC outlet. Do not connect the AC adaptor to a ceiling-mounted AC outlet, as the weight of the adaptor may cause it to become disconnected.

During a power failure

The base unit will work as a standard telephone using power from the telephone line. Line 1 on the corded handset can be used to make and answer calls. The base unit speakerphone and the cordless handset will not function during a power failure.

Connecting the telephone line cord

Refer to one of the following methods depending on your situation:

- To connect to a 2-line telephone jack: page 13
- To connect to 2 single-line telephone jacks: page 13
- If you use the unit as a single-line telephone only: page 13

Connect the telephone line cord until it clicks into the base unit and telephone line jack.

To connect to a 2-line telephone jack

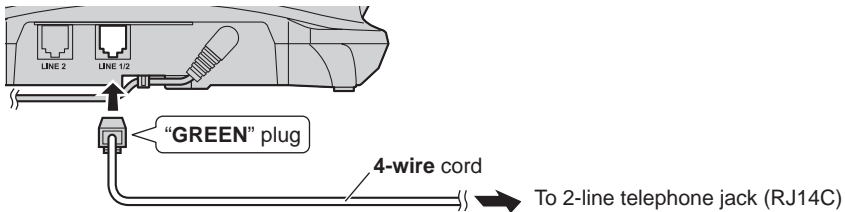

To connect to 2 single-line telephone jacks

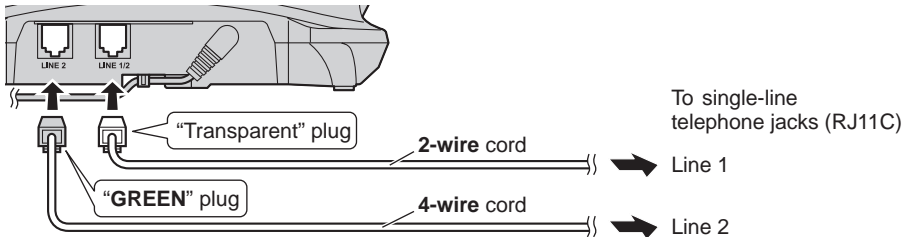

If you use the unit as a single-line telephone only

Be sure to connect the telephone line cord to LINE 1/2 to allow usage of the unit during a power failure (page 12). Change the line selection mode from "Auto" to "Line1" (page 17).

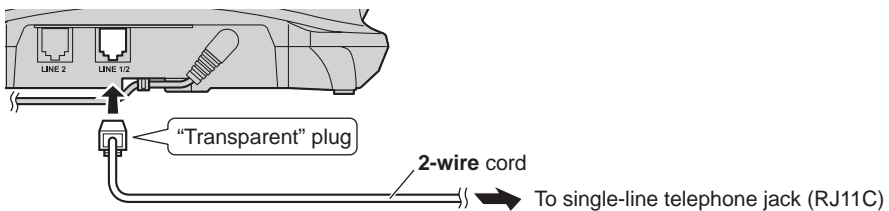

Note:

- "Check tel line 2" is displayed on the unit. To erase it, see page 47.

Preparation

If you subscribe to a DSL/ADSL service

Please attach a DSL/ADSL filter (contact your DSL/ADSL provider) to the telephone line between the base unit and the telephone line jack in the event of the following:

- noise is heard during conversations.
 - Caller ID features do not function properly.
-

To connect to a 2-line telephone jack

For this connection, please purchase a Panasonic 2-line splitter (page 4).

Example: DSL/ADSL line is line 2

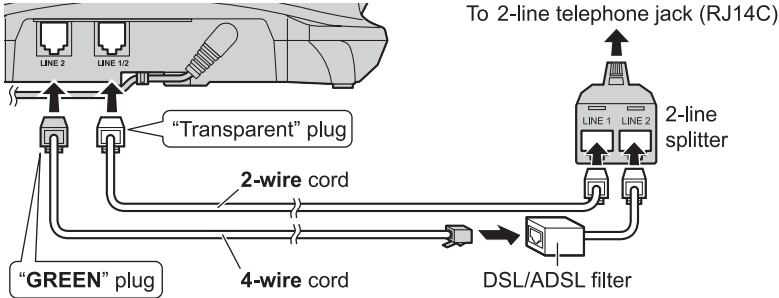

To connect to 2 single-line telephone jacks

Example: DSL/ADSL line is line 2

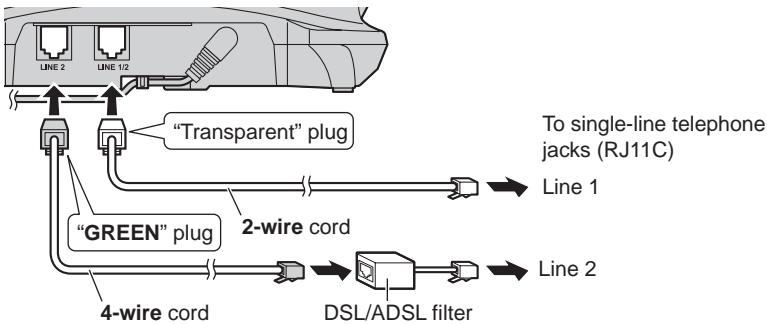

Battery installation and replacement

Important:

- Use the supplied rechargeable batteries (Part No. HHR-55AAABU).
 - When installing the batteries:
 - Wipe the battery ends (+, -) with a dry cloth.
 - Avoid touching the battery ends (+, -) or the unit contacts.
 - Confirm correct polarities (+, -).
 - When replacing the batteries:
 - USE ONLY rechargeable Ni-MH batteries AAA (R03) size.
 - Do NOT use Alkaline/Manganese/Ni-Cd batteries.
 - We recommend using the Panasonic rechargeable batteries noted on page 4, 6.
- 1** Press the notch on the handset cover firmly, and slide it in the direction of the arrow.

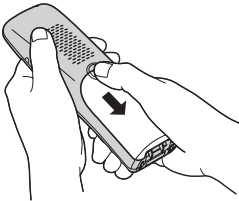

- 2** Insert the batteries negative (-) end first. Close the handset cover.

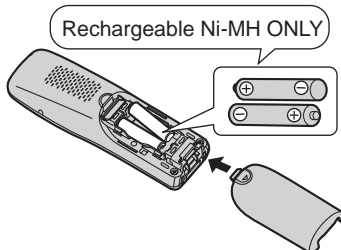

Note:

- When replacing batteries, remove the old batteries.

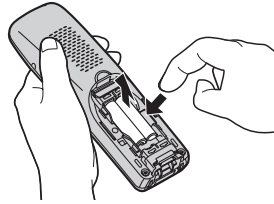

Attention:



A nickel metal hydride battery that is recyclable powers the product you have purchased. Please call 1-800-8-BATTERY (1-800-822-8837) for information on how to recycle this battery.

Battery charge

Place the handset on the charger for about 7 hours before initial use.

- While charging, “Charging” is displayed and the charge indicator on the handset lights up. When the batteries are fully charged, “Charge completed” is displayed.







Note:

- It is normal for the handset to feel warm during charging.

Preparation

- If you want to use the handset immediately, charge the batteries for at least 15 minutes.
- Clean the charge contacts of the handset and charger with a soft and dry cloth once a month. Clean more often if the unit is exposed to grease, dust, or high humidity.

Battery level

Battery icon	Battery level
	High
	Medium
	Low <ul style="list-style-type: none">• When flashing: Needs to be charged.
	Empty

Note:

- The batteries need to be charged if the handset beeps while you are engaged in a call or operating the answering system remotely.

Panasonic Ni-MH battery performance (supplied batteries)

Operation	Operating time
In continuous use	12 hours max.
Not in use (standby)	6 days max.

Note:

- Actual battery performance depends on a combination of how often the handset is in use and how often it is not in use (standby).
- Even after the handset is fully charged, the handset can be left on the charger without any ill effect on the batteries.
- The battery level may not be displayed correctly after you replace the batteries. In this case, place the handset on the charger and let it charge for at least 7 hours.

Setting up the unit before use

Display language



You can select either “English” or “Español” as the display language. The default setting is “English”.

 Base unit /  Handset

- 1 [MENU] → [Ⓜ][1][1][0]
- 2 [▼]/[▲]: Select the desired setting.
- 3 Press the middle soft key to save.
- 4 Proceed with the operation for your unit.
Base unit: [■] (EXIT)
Handset: [OFF]

Voice guidance language

You can select either “English” or “Español” as the voice guidance language of the answering system. The default setting is “English”. Program this setting using either the base unit or one of the handsets.

 Base unit /  Handset

- 1 [MENU] → [Ⓜ][1][1][2]
- 2 [▼]/[▲]: Select the desired setting.
- 3 [SAVE]
- 4 Proceed with the operation for your unit.
Base unit: [■] (EXIT)
Handset: [OFF]

Dialing mode

If you cannot make calls, change this setting according to your telephone line service. The default setting is “Tone”.

“Tone”: For tone dial service.

“Pulse”: For rotary/pulse dial service.

Program this setting using either the base unit or one of the handsets.

 Base unit /  Handset

- 1 [MENU] → [Ⓜ][1][2][0]
- 2 [▼]/[▲]: Select the desired setting.
- 3 [SAVE]

- 4 Proceed with the operation for your unit.

Base unit: [■] (EXIT)

Handset: [OFF]

Date and time

Program this setting using either the base unit or one of the handsets.

Base unit / Handset

- 1 [MENU] → [⇄][1][0][1]
- 2 Enter the current month, date, and year by selecting 2 digits for each.
Example: September 15, 2008
[0][9] [1][5] [0][8]
- 3 Enter the current hour and minute (12-hour clock format) by selecting 2 digits for each.
Example: 9:30
[0][9] [3][0]
- 4 Press [✳] to select "AM" or "PM".
- 5 [SAVE]
- 6 Proceed with the operation for your unit.
Base unit: [■] (EXIT)
Handset: [OFF]

Note:

- When English is selected as the display language, 12-hour clock format is used. When Spanish is selected, 24-hour clock format is used.
- To correct a digit:
Base unit: Press [▲], [▼], [◀], or [▶] to move the cursor to the digit, then make the correction.
Handset: Press [▲], [▼], [◀], or [▶] to move the cursor to the digit, then make the correction.
- The date and time may be incorrect after a power failure. In this case, set the date and time again.

Line selection mode

The line selection mode determines which line is selected when:

- you lift the corded handset
- you press [SP-PHONE] on the base unit (when making/answering calls)
- you press [📞]/[📞] on the handset (when making/answering calls)

The following setting is available:

- "Auto" (default): When making a call, line 1 is selected. If that line is unavailable, line 2 is selected. When you call back using the caller list (page 33) or while listening to a message (page 37, 38), the indicated line is used. When answering a call, the ringing line is selected.
- "Line1": Line 1 is selected.
- "Line2": Line 2 is selected.

Base unit / Handset

- 1 [MENU] → [⇄][2][5][0]
- 2 [▼]/[▲]: Select the desired setting.
- 3 [SAVE]
- 4 Proceed with the operation for your unit.
Base unit: [■] (EXIT)
Handset: [OFF]

Note:

- You can select a line manually regardless of the line selection mode by pressing [LINE 1] or [LINE 2].

Making calls

Using the base unit

- 1 Dial the phone number.
 - To correct a digit, press **[CLEAR]**.
- 2 Lift the corded handset.
 - An available line is automatically selected and either the LINE1 indicator or LINE2 indicator lights up. To change the line selection mode, see page 17.
 - You can also select the line manually by pressing **[LINE 1]** or **[LINE 2]** before lifting the corded handset.
- 3 When you finish talking, place the corded handset on the cradle.

Note:

- You can also dial the phone number after lifting the corded handset.
- To switch to the cordless handset, press **[LINE 1]** or **[LINE 2]** on the cordless handset, then place the corded handset on the cradle.

Using the speakerphone

- 1 During a conversation with the corded handset, press **[SP-PHONE]** to turn on the speakerphone.
 - You can place the corded handset on the cradle.
 - Speak into the MIC.
 - Speak alternately with the other party.
- 2 When you finish talking, press **[SP-PHONE]**.

Note:

- For best performance, use the speakerphone in a quiet environment.
- To switch to the receiver, lift the corded handset.

Using the handset

- 1 Lift the handset and dial the phone number.
 - To correct a digit, press **[CLEAR]**.
- 2 
 - An available line is automatically selected and the line number is displayed. To change the line selection mode, see page 17.
 - You can also select the line manually by pressing **[LINE 1]** or **[LINE 2]**.

- 3 When you finish talking, press **[OFF]** or place the handset on the charger.

Note:

- The LINE1 indicator or LINE2 indicator on the base unit lights up while using the handset.

Using the speakerphone

- 1 During a conversation, press  to turn on the speakerphone.
 - Speak alternately with the other party.
- 2 When you finish talking, press **[OFF]**.

Note:

- For best performance, use the speakerphone in a quiet environment.
- To switch to the receiver, press .

Adjusting the receiver or speaker volume

 Base unit /  Handset

Press **[▲]** or **[▼]** repeatedly while talking.

Making a call using the redial list

The last 10 phone numbers dialed are stored in the redial list in each unit (each 48 digits max.).

 Base unit /  Handset

- 1 **[REDIAL]**
- 2 **[▼]/[▲]**: Select the desired phone number.
- 3 Proceed with the operation for your unit.
Base unit: Lift the corded handset.
Handset: 

Erasing a number in the redial list

- 1 **[REDIAL]**
- 2 **[▼]/[▲]**: Select the desired phone number.
→ **[ERASE]**
- 3 **[▼]/[▲]**: "Yes" → **[SELECT]**
- 4 Proceed with the operation for your unit.
Base unit: **[■]** (EXIT)
Handset: **[OFF]**

Pause (for PBX/long distance service users)

A pause is sometimes required when making calls using a PBX or long distance service. When

storing a calling card access number and/or PIN in the phonebook, a pause is also needed (page 24).

Base unit / Handset

Example: If you need to dial the line access number "9" when making outside calls with a PBX:

- 1 **[9]** → **[PAUSE]**
- 2 Dial the phone number.
- 3 Proceed with the operation for your unit.
Base unit: Lift the corded handset.
Handset: **[📞]**

Note:

- A 3.5 second pause is inserted each time **[PAUSE]** is pressed. Repeat as needed to create longer pauses.

Answering calls

Using the base unit

When a call is being received, the LINE1 indicator and/or LINE2 indicator on the base unit flashes rapidly.

- 1 Lift the corded handset or press **[SP-PHONE]** when the unit rings.
 - The called line is automatically selected. To change the line selection mode, see page 17.
 - You can also answer the call by pressing **[LINE 1]** or **[LINE 2]**.
- 2 When you finish talking, place the corded handset on the cradle. When the speakerphone is used, press **[SP-PHONE]**.

Adjusting the base unit ringer volume

Press **[▲]** or **[▼]** repeatedly to select the desired volume while the base unit is ringing for an incoming call.



Note:

- You can also program the base unit ringer volume beforehand (page 29).

Temporary base unit ringer off

While the base unit is ringing for a call, you can turn the ringer off temporarily by pressing **[🔕]**.

Using the handset

When a call is being received, the ringer indicator and  and/or  flashes rapidly.

- 1 Lift the handset and press **[📞]** or **[📞]** when the unit rings.
 - The called line is automatically selected. To change the line selection mode, see page 17.
 - You can also answer the call by pressing **[LINE 1]** or **[LINE 2]**.
 - You can also answer the call by pressing any dial key from **[0]** to **[9]**, **[*]**, or **[#]**.
(Any key answer feature)
- 2 When you finish talking, press **[OFF]** or place the handset on the charger.

Auto talk

You can answer calls simply by lifting the handset off the charger. You do not need to press **[📞]**. To turn this feature on, see page 28.

Adjusting the handset ringer volume

Press **[▲]** or **[▼]** repeatedly to select the desired volume while the handset is ringing for an incoming call.

Note:

- You can also program the handset ringer volume beforehand (page 29).

Temporary handset ringer off

While the handset is ringing for a call, you can turn the ringer off temporarily by pressing **[OFF]**.

Useful features during a call

Hold

This feature allows you to put an outside call on hold.

Base unit

- 1 Press **[HOLD]** during an outside call.
 - If you are using the corded handset, you can place it on the cradle.
- 2 To release hold, press **[LINE 1]** or **[LINE 2]** that is flashing on the base unit.

Handset

- 1 Press **[HOLD]** 2 times during an outside call.
- 2 To release hold, press **[LINE 1]** or **[LINE 2]** that is flashing on the handset.

Note for base unit and handset:

- If a call is kept on hold for more than 9 minutes, an alarm tone starts to sound and the ringer indicator flashes rapidly. After 1 additional minute on hold, the call is disconnected.
- If another phone is connected to the same line, you can also take the call by lifting its handset.

Mute

While mute is turned on, you can hear the other party, but the other party cannot hear you.

Base unit / Handset

- 1 Press **[MUTE]** during an outside call.
 - **[MUTE]** flashes.
- 2 To return to the conversation, press **[MUTE]** again.

Note:

- **[MUTE]** is a soft key visible on the display during a call.

Flash

Base unit / Handset

[FLASH] allows you to use the special features of your host PBX such as transferring an extension call, or accessing optional telephone services.

Note:

- To change the flash time, see page 29.

For call waiting or Call Waiting Caller ID service users

To use call waiting, you must first subscribe to the call waiting service of your service provider/telephone company.

This feature allows you to receive calls while you are already talking on the phone. If you receive a call while on the phone, you will hear a call waiting tone.

If you subscribe to both Caller ID and Call Waiting with Caller ID services, the 2nd caller's information is displayed on the base unit or handset that is in use after you hear the call waiting tone.

Base unit / Handset

- 1 Press **[CALL WAIT]** to answer the 2nd call.
- 2 To switch between calls, press **[CALL WAIT]**.

Note:

- Please contact your service provider/telephone company for details and availability of this service in your area.

Temporary tone dialing (for rotary/pulse service users)

You can temporarily switch the dialing mode to tone when you need to access touch-tone services (for example, answering services, telephone banking services, etc.).

Base unit / Handset

Press **[*]** (TONE) before entering access numbers which require tone dialing.

Call share

This feature allows you to join an existing outside call.

Base unit

To join the conversation, press **[LINE 1]** or **[LINE 2]** to select the line that is being used by another extension for an outside call, then lift the corded handset.

Handset

To join the conversation, press **[LINE 1]** or **[LINE 2]** to select the line that is being used by another extension for an outside call.

Note for base unit and handset:

- A maximum of 3 parties (including 1 outside party) can join a conversation.

Call privacy

Call privacy allows you to prevent other users from joining your conversations with outside callers. To allow other users to join your conversations, leave this feature off. The default setting is "OFF".

Base unit

- 1 Press **[MENU]** during an outside call.
 - If any options appear on the display, perform the following:
[v]/[▲]: "Privacy" → [SELECT]
- 2 **[v]/[▲]: "On" or "Off" → [SELECT]**
 - When this feature is turned on, "PRIV." is displayed.

Handset

- 1 Press **[MENU]** during an outside call.
- 2 **[v]/[▲]: "Privacy" → [SELECT]**
- 3 **[v]/[▲]: "On" or "Off" → [SELECT]**
 - When this feature is turned on, "PRIV." is displayed.

Note for base unit and handset:

- This feature will turn off after you hang up the call.

Using the other line during a call

You can use the other line in the following ways:

- When a call is being received on the other line during a conversation, an interrupt tone will be heard (page 28). You can answer the 2nd call while holding the 1st call.
- During an outside call, you can also make a call using the other line by holding the 1st call.

Base unit

Example: If you are using line 1:

- 1 Press **[HOLD]** to put the 1st call (line 1) on hold.
- 2 Press **[LINE 2]** to make or answer a 2nd call.
 - To hold the 2nd call, press **[HOLD]**.
- 3 To return to the 1st call (line 1), press **[LINE 1]**.

Handset

Example: If you are using line 1:

- 1 Press **[HOLD]** 2 times to put the 1st call (line 1) on hold.
- 2 Press **[LINE 2]** to make or answer a 2nd call.
 - To hold the 2nd call, press **[HOLD]** 2 times.
- 3 To return to the 1st call (line 1), press **[LINE 1]**.

Note for base unit and handset:

- If you subscribe to Caller ID, the 2nd caller's information is displayed when a call is being received on the other line (page 33).

Base unit/handset phonebook

The phonebook allows you to make calls without having to dial manually. You can add names and phone numbers to the base unit and handset phonebook independently, and assign each phonebook entry to the desired group.

- Base unit: up to 100 entries
- Handset: up to 100 entries

Adding entries

 Base unit /  Handset

- 1 Proceed with the operation for your unit.
Base unit: [📞]
Handset: [MENU] → [⊕][2][8][0]
- 2 [ADD]
- 3 Enter the party's name (16 characters max.).
 → [OK]
- 4 Enter the party's phone number (24 digits max.). → [OK]
- 5 [▼]/[▲]: Select the desired group. → [SELECT] 2 times
 - To add other entries, repeat from step 3.
- 6 Proceed with the operation for your unit.
Base unit: [■] (EXIT)
Handset: [OFF]

Note:

- Caller ID subscribers can use group ringer tone feature (page 33).

Character table for entering names

While entering characters, you can switch between uppercase and lowercase by pressing [✱].

Key	Character
[1]	Space # & ' () * , - . / 1
[2]	A B C 2
	a b c 2
[3]	D E F 3
	d e f 3
[4]	G H I 4
	g h i 4

Key	Character
[5]	J K L 5
	j k l 5
[6]	M N O 6
	m n o 6
[7]	P Q R S 7
	p q r s 7
[8]	T U V 8
	t u v 8
[9]	W X Y Z 9
	w x y z 9
[0]	Space 0

- To enter another character that is located on the same dial key:
Base unit: Press [▶▶] to move the cursor to the next space.
Handset: Press [▶] to move the cursor to the next space.

Correcting a mistake

- 1 Proceed with the operation for your unit.
Base unit: Press [◀◀] or [▶▶] to move the cursor to the character or number you want to erase.
Handset: Press [◀] or [▶] to move the cursor to the character or number you want to erase.
- 2 Press [CLEAR], and then enter the appropriate character or number.
 - Press and hold [CLEAR] to erase all characters or numbers.

Groups

Groups can help you find entries in the phonebook quickly and easily. When adding an entry to the phonebook, you can assign it to one of 9 groups. You can change the names of groups assigned for phonebook entries ("Friends", "Family", etc.) and then search for phonebook entries by group. The group ringer tone feature is available for Caller ID subscribers (page 33).

Changing group names

The default group name is "Group 1" to "Group 9".

 Base unit /  Handset

- 1 Proceed with the operation for your unit.
Base unit: [📖]
Handset: [MENU] → [⊕][2][8][0]
- 2 [MENU]
- 3 [▼]/[▲]: “Group” → [SELECT]
- 4 [▼]/[▲]: Select the desired group. → [SELECT]
- 5 [▼]/[▲]: “Group name” → [SELECT]
- 6 Edit the name (10 characters max.; page 22). → [SAVE]
- 7 Proceed with the operation for your unit.
Base unit: [■] (EXIT)
Handset: [OFF]

Finding and calling a phonebook entry

 Base unit /  Handset

Once you have found the desired entry using one of the following 3 methods, make a call with your unit.

Base unit: Lift the corded handset.

- You can also make a call by pressing [LINE 1] or [LINE 2], then lifting the corded handset.

Handset: [📞]

- You can also make a call by pressing [CALL], then pressing [LINE 1] or [LINE 2].

Scrolling through all entries

- 1 Proceed with the operation for your unit.
Base unit: [📖]
Handset: [MENU] → [⊕][2][8][0]
- 2 [▼]/[▲]: Select the desired entry.

Searching by first character (alphabetically)

- 1 Proceed with the operation for your unit.
Base unit: [📖]
Handset: [MENU] → [⊕][2][8][0]
- 2 Press the dial key ([0] - [9]) which contains the character you are searching for (page 22).
 - Press the same dial key repeatedly to display the first entry corresponding to each character located on that dial key.
 - If there is no entry corresponding to the character you selected, the next entry is displayed.

- 3 [▼]/[▲]: Scroll through the phonebook if necessary.

Searching by group

- 1 Proceed with the operation for your unit.
Base unit: [📖]
Handset: [MENU] → [⊕][2][8][0]
- 2 [GROUP]
- 3 [▼]/[▲]: Select the group you want to search. → [SELECT]
 - If you select “All groups”, the unit ends the group search.
- 4 [▼]/[▲]: Scroll through the phonebook if necessary.

Editing entries

 Base unit /  Handset

- 1 Find the desired entry (page 23). → [MENU]
- 2 [▼]/[▲]: “Edit” → [SELECT]
- 3 Edit the name if necessary (16 characters max.; page 22). → [OK]
- 4 Edit the phone number if necessary (24 digits max.). → [OK]
- 5 [▼]/[▲]: Select the desired group (page 22). → [SELECT] 2 times
- 6 Proceed with the operation for your unit.
Base unit: [■] (EXIT)
Handset: [OFF]

Erasing entries

 Base unit /  Handset

Erasing an entry

- 1 Find the desired entry (page 23).
- 2 [MENU]
- 3 [▼]/[▲]: “Erase” → [SELECT]
- 4 [▼]/[▲]: “Yes” → [SELECT]
- 5 Proceed with the operation for your unit.
Base unit: [■] (EXIT)
Handset: [OFF]

Erasing all entries

- 1 Proceed with the operation for your unit.
Base unit: [📖]

Handset: [MENU] → [#][2][8][0]

- 2 [MENU]
- 3 [▼]/[▲]: "Erase all" → [SELECT]
- 4 [▼]/[▲]: "Yes" → [SELECT]
- 5 [▼]/[▲]: "Yes" → [SELECT]
- 6 Proceed with the operation for your unit.
Base unit: [■] (EXIT)
Handset: [OFF]

Chain dial

This feature allows you to dial phone numbers in the phonebook while you are on a call. This feature can be used, for example, to dial a calling card access number or bank account PIN that you have stored in the phonebook, without having to dial manually.

Base unit / Handset

- 1 Proceed with the operation for your unit.
During an outside call:
Base unit: [📖]
Handset: [MENU] → [▼]/[▲]:
"Phonebook" → [SELECT]
- 2 [▼]/[▲]: Select the desired entry.
- 3 Press [CALL] to dial the number.

Note:

- When storing a calling card access number and your PIN in the phonebook as one phonebook entry, press [PAUSE] to add pauses after the number and PIN as necessary (page 18).
- If you have rotary/pulse service, you need to press [*] before pressing [📖] on the base unit or [MENU] on the handset in step 1 to change the dialing mode temporarily to tone.

Copying phonebook entries

You can copy phonebook entries from the base unit to a handset or vice versa.

Important:

- Group ringer tones are not copied.
- You cannot copy the phonebook entries between handsets.

Copying an entry

Base unit

- 1 [📖]
- 2 [▼]/[▲]: Select the desired entry. → [MENU]
- 3 [▼]/[▲]: "Copy" → [SELECT]
- 4 [▼]/[▲]: Enter the handset number to copy to.
 - When an entry has been copied, "Completed" is displayed.
 - To continue copying another entry:
[▼]/[▲]: "Yes" → [SELECT] → Find the desired entry (page 23). → [SEND]
- 5 [■] (EXIT)

Handset

- 1 [MENU] → [#][2][8][0]
- 2 [▼]/[▲]: Select the desired entry. → [MENU]
- 3 [▼]/[▲]: "Copy to base" → [SELECT]
 - When an entry has been copied, "Completed" is displayed.
 - To continue copying another entry:
[▼]/[▲]: "Yes" → [SELECT] → Find the desired entry (page 23). → [SEND]
- 4 [OFF]

Copying all entries

Base unit

- 1 [📖] → [MENU]
- 2 [▼]/[▲]: "Copy all" → [SELECT]
- 3 [▼]/[▲]: Enter the handset number to copy to.
 - When all entries have been copied, "Completed" is displayed.
- 4 [■] (EXIT)

Handset

- 1 [MENU] → [#][2][8][0] → [MENU]
- 2 [▼]/[▲]: "Copy all to base" → [SELECT]
 - When all entries have been copied, "Completed" is displayed.
- 3 [OFF]

Programmable settings

You can customize the unit by programming the following features.

To access the features, there are 2 methods:

- scrolling through the display menus (page 25)
- using the direct commands (page 28)

- Mainly the direct command method is used in these operating instructions.

Programming by scrolling through the display menus



 Base unit /  Handset

- 1 **[MENU]**
- 2 Proceed with the operation for your unit.
Base unit: Press **[▼]**, **[▲]**, **[◀◀]**, or **[▶▶]** to select the desired main menu. → **[SELECT]**
Handset: Press **[▼]**, **[▲]**, **[◀]**, or **[▶]** to select the desired menu. → **[SELECT]**
- 3 Press **[▼]** or **[▲]** to select the desired item in sub-menu 1. → **[SELECT]**
 - In some cases, you may need to select from sub-menu 2. → **[SELECT]**
- 4 Press **[▼]** or **[▲]** to select the desired setting. → **[SAVE]**
 - This step may vary depending on the feature being programmed.
 - To exit the operation, press **[■]**(EXIT) on the base unit or **[OFF]** on the handset.



Note:

- See page 28 for the default settings.

Base unit



Main menu	Sub-menu 1	Sub-menu 2	Page
View Caller ID 	-	-	33
Phonebook 	-	-	22
Set answering 	Record greeting	Line1&Line2	36
		Line1	
		Line2	
	Play greeting	Line1&Line2	37
		Line1	
		Line2	
	Ring count ^{*1}	-	41
	Recording time ^{*1}	-	41
Remote code ^{*1}	-	39	
Call screening	-	36	



Programming

Main menu	Sub-menu 1	Sub-menu 2	Page
Ringer settings 	Ringer volume	Line1	-
		Line2	
	Ringer tone	Line1	-
		Line2	
	Interrupt tone	-	-
Night mode	Start/End	31	
	On/Off	31	
Initial settings 	Set date & time	Date and time ^{*1}	17
		Time adjustment ^{*1}	-
	Contrast	-	-
	Line select	-	17
	Set tel line	Caller ID edit	34
		Set dial mode ^{*1}	16
		Set flash time ^{*1}	29
		- Line1	-
		- Line2	
	Set line mode ^{*1}	-	
- Line1	-		
- Line2			
VM tone detect ^{*1}	42		
Change language	Display language	16	
	Voice prompt ^{*1}	16	
Customer support 	-	-	31

*1 If you program these settings using the base unit, you do not need to program the same item using a handset.

Handset

Main menu	Sub-menu 1	Sub-menu 2	Page
View Caller ID 	-	-	33
Phonebook 	-	-	22
Answering device 	Play new msg.	-	-
	Play all msg.	-	-
	Erase all	-	-
	Settings	Ring count ^{*1}	41
		Recording time ^{*1}	41
		Remote code ^{*1}	39
Call screening		36	

Main menu	Sub-menu 1	Sub-menu 2	Page
Ringer settings 	Ringer volume	Line1	–
		Line2	–
	Ringer tone	Line1	–
		Line2	–
	Interrupt tone	–	–
	Night mode	Start/End	31
On/Off		31	
Initial settings 	Set date & time	Date and time ^{*1}	17
		Alarm	31
		Time adjustment ^{*1}	–
	Contrast	–	–
	Key tone	–	–
	Auto talk	–	19
	Line select	–	17
	Set tel line	Caller ID edit	34
		Set dial mode ^{*1}	16
		Set flash time ^{*1}	29
		– Line1	
		– Line2	
	Set line mode ^{*1}	– Line1	–
		– Line2	–
		VM tone detect ^{*1}	42
Registration	HS registration	32	
	Deregistration	32	
Change language	Display language	16	
	Voice prompt ^{*1}	16	
Customer support 	–	–	31

*1 If you program these settings using one of the handsets, you do not need to program the same item using another unit.

Programming using the direct commands



1 [MENU] → [⇄]















2 Enter the desired feature code.



















3 [▼]/[▲]: Select the desired setting. → [SAVE]

- This step may vary depending on the feature being programmed.
- To exit the operation, press [■](EXIT) on the base unit or [OFF] on the handset.

Note:

- The operating unit column shows the unit(s) that can be used to program the item.
 - : Only the base unit can program the item.
 - : Only the handset can program the item.
 - : Both the base unit and handset can program the item.
- In the following table, < > indicates the default settings.

Operating unit	Feature	Feature code	Setting	System setting ^{*1}	Page
	Alarm	[7][2][0]	<Off> Once Daily	–	31
	Auto talk ^{*2}	[2][0][0]	On <Off>	–	19
	Caller ID edit (Caller ID number auto edit)	[2][1][4]	<On> Off	–	34
	Call screening	[3][1][0]	<On> Off	–	36
	Contrast (Display contrast)	[1][4][5]	Level 1–6 <3>	–	–
	Customer support	[6][8][0]	–	–	31
	Date and time	[1][0][1]	–	●	17
	Deregistration	[1][3][1]	–	–	32
	Display language	[1][1][0]	<English> Español	–	16
	Erase all (Erasing all messages)	[3][2][5]	–	–	38
	HS registration (Handset registration)	[1][3][0]	–	–	32
	Interrupt tone ^{*3}	[2][0][1]	<On> Off	–	43
	Key tone ^{*4}	[1][6][5]	<On> Off	–	–
	Line select	[2][5][0]	<Auto> Line1 Line2	–	17
	Night mode (On/Off)	[2][3][8]	On <Off>	–	31

Operating unit	Feature	Feature code	Setting	System setting ^{*1}	Page
	Night mode (Start/End)	[2][3][7]	<11:00 PM/06:00 AM>	–	31
	Phonebook	[2][8][0]	–	–	22
	Play all msg.	[3][2][4]	–	–	38
	Play greeting	[3][0][3]	–	–	37
	Play new msg.	[3][2][3]	–	–	38
	Record greeting	[3][0][2]	–	–	36
	Recording time	[3][0][5]	1min 2min <3min>	●	41
	Remote code	[3][0][6]	<111>	●	39
	Ring count	[2][1][1]	Toll saver 2–7 rings <4>	●	41
	Ringer tone ^{*5, *6}	[1][6][1]	Line 1 Line 2 Line 1: <Tone 1> Line 2: <Tone 2> Base unit: Tone 1–3 Melody 1–3 Handset: Tone 1–5 Melody 1–10	–	–
	Ringer volume ^{*7}	[1][6][0]	Line 1 Line 2 Base unit: Level 1–<3>, Off Handset: Level 1–<6>, Off	–	–
	Set dial mode	[1][2][0]	<Tone> Pulse	●	16
	Set flash time ^{*8}	[1][2][1]	Line 1 Line 2 80ms 90ms 100ms 110ms 160ms 200ms 250ms 300ms 400ms 600ms <700ms> 900ms	●	20
	Set line mode ^{*9}	[1][2][2]	Line 1 Line 2 A 	●	–
	Time adjustment ^{*10} (Caller ID subscribers only)	[2][2][6]	<Caller ID[auto]> Manual	●	–
	View Caller ID	[2][1][3]	–	–	33
	VM tone detect	[3][3][2]	<On> Off	●	42
	Voice prompt	[1][1][2]	<English> Español	●	16

*1 If “System setting” column is checked, you do not need to program the same item using another unit.

*2 If you subscribe to Caller ID service and want to view the caller's information after lifting up the handset to answer a call, turn off this feature.

Programming

- *3 This tone lets you know when you receive an outside call while you are on the other line or an intercom call. If you select “on”, the tone sounds 2 times.
- *4 Turn this feature off if you prefer not to hear key tones while you are dialing or pressing any keys, including confirmation tones and error tones.
- *5 If you subscribe to a distinctive ring service (such as IDENT-A-RING), select a tone (base unit: tone 1 to 3/handset: tone 1 to 5). If you select a melody, you cannot distinguish lines by their ringers.
- *6 If you select one of the melody ringer tones, the ringer tone will continue to play for several seconds even if the caller has already hung up. You may either hear a dial tone or no one on the line when you answer the call.
- *7 When the ringer volume is turned off, μ is displayed followed by the selected line number(s) and the base unit and/or handset do not ring for outside calls.
- *8 The flash time depends on your telephone exchange or host PBX. Contact your PBX supplier if necessary. The setting should stay at “700ms” unless pressing **[FLASH]** fails to pick up the waiting call.
- *9 Generally, the line mode setting should not be adjusted. If the LINE1 indicator or LINE2 indicator does not light when another phone connected to the same line is in use, you need to change the line mode to “A”.
- *10 This feature allows the unit to automatically adjust the date and time setting when caller information is received. To use this feature, set the date and time first.

Special instructions for programmable settings

Night mode

Night mode allows you to select a span of time during which the unit will not ring for outside calls. This feature is useful for those occasions when you do not want to be disturbed, for example, while sleeping. Night mode can be set independently for each base unit and handset.

Important:

- Set the date and time beforehand (page 17).
- If you have set the alarm, the alarm sounds even if the night mode is turned on.

Setting the start and end time

Base unit / Handset

- 1 **[MENU]** → **[#][2][3][7]**
- 2 Enter the desired hour and minute you wish to start this feature.
- 3 Press **[*]** to select “AM” or “PM”. → **[OK]**
- 4 Enter the desired hour and minute you wish to end this feature.
- 5 Press **[*]** to select “AM” or “PM”. → **[OK]**
- 6 Proceed with the operation for your unit.
Base unit: **[■]** (EXIT)
Handset: **[OFF]**

Note:

- To correct a digit:
Base unit: Press **[◀]** or **[▶]** to move the cursor to the digit, then make the correction.
Handset: Press **[←]** or **[→]** to move the cursor to the digit, then make the correction.

Turning night mode on/off

Base unit / Handset

- 1 **[MENU]** → **[#][2][3][8]**
- 2 **[▼]/[▲]**: Select “on” or “off”. → **[SAVE]**
- 3 Proceed with the operation for your unit.
Base unit: **[■]** (EXIT)
Handset: **[OFF]**

Note:

- When the night mode is turned on,  is displayed.

Alarm

An alarm sounds at the set time for 3 minutes once or daily. Alarm can be set for each handset.

Important:

- Set the date and time beforehand (page 17).

Handset

- 1 **[MENU]** → **[#][7][2][0]**
- 2 **[▼]/[▲]**: Select the desired alarm option. → **[SELECT]**

off	Turns alarm off. Go to step 5.
Once	An alarm sounds once at the set time. Enter the desired month, date, and year.
Daily	An alarm sounds daily at the set time.

- 3 Set the desired time. → **[OK]**
- 4 **[▼]/[▲]**: Select the desired ringer tone. → **[SELECT]**
 - We recommend selecting a ringer tone different from the ringer tone set for outside calls.
- 5 **[▼]/[▲]**: “Save” → **[SELECT]** → **[OFF]**
 - When the alarm is set,  is displayed.

Note:

- To stop the alarm, press any dial key or place the handset on the charger.
- When the handset is in use, the alarm will not sound until the handset is in standby mode.
- If you select “once”, the setting changes to “off” after the alarm sounds.
- The ringer volume for alarm follows the higher volume level of the 2 lines (page 29).
- When the ringer volume for outside calls of the 2 lines is set to off (page 29), the alarm sound is heard at a low level.

Customer support

The base unit and handset can display the Internet address where you can download the operating instructions or get further information for this product by using your computer.

Base unit / Handset

- 1 **[MENU]** → **[#][6][8][0]**

- 2 Proceed with the operation for your unit.

Base unit: [■] (EXIT)

Handset: [OFF]

Registering a unit

Operating additional handsets

Additional handsets

Up to 6 handsets can be registered to the base unit.

Important:

- See page 5 for information on the available model.
-

Registering a handset to the base unit

The supplied handset and base unit are pre-registered. If for some reason the handset is not registered to the base unit, register the handset.

1 Handset:

[MENU] → [⊕][1][3][0]

2 Base unit:

Press and hold [LOCATOR] for 5 seconds until the registration tone sounds.

- If all registered handsets start ringing, press the same button to stop. Then repeat this step.
- The next step should be completed within 90 seconds.

3 Handset:

Press [OK], then wait until a long beep sounds.

Note:

- When you purchase an additional handset, refer to the additional handset's installation manual for registration.
-

Deregistering a handset

A handset can cancel its own registration (or the registration of another handset) that is stored in the base unit. This allows the handset to end its wireless connection with the system.

Handset

1 [MENU] → [⊕][1][3][1]

2 [3][3][5] → [OK]

- 3** Select the handset you want to cancel by pressing the desired handset(s) number.

- The selected handset number(s) flashes.
- To cancel a selected handset number, press the number again. The number will stop flashing.

4 [OK] → [▼]/[▲]: “Yes” → [SELECT]

- When you cancel a different handset than the one you are now using, press [OFF] to exit.
-

Using Caller ID service

Important:

- This unit is Caller ID compatible. To use Caller ID features, you must subscribe to Caller ID service. Contact your service provider/telephone company for details.

Caller ID features

When an outside call is being received, the caller's name and phone number are displayed.

Caller information for the last 50 callers is logged in the caller list from the most recent call to the oldest.

- If the unit cannot receive caller information, the following is displayed:
 - “**Out of area**”: The caller dials from an area which does not provide Caller ID service.
 - “**Private caller**”: The caller requests not to send caller information.
 - “**Long distance**”: The caller makes a long distance call.
- If the unit is connected to a PBX system, caller information may not be received properly. Contact your PBX supplier.

Missed calls

If a call is not answered, the unit treats the call as a missed call. The display shows “**Missed call**”. This lets you know if you should view the caller list to see who called while you were away.

Phonebook name display

When caller information is received and it matches a phone number stored in the phonebook, the stored name in the phonebook is displayed and logged in the caller list.

Group ringer tone for phonebook

This feature can help you identify who is calling by using different ringer tones for different groups of callers. When adding an entry to the phonebook, you can assign it to the desired group (page 22). When a call is received from a caller assigned to a group, the group's ringer you selected rings after the caller information is displayed. If you select “**No ringer ID**” (default), the unit uses the ringer tone you selected for each line on page 29 when calls from this group are received.

Base unit / Handset

- 1 Proceed with the operation for your unit.
Base unit: 
Handset: [MENU] → [Ⓜ][2][8][0]
- 2 [MENU]
- 3 [▼]/[▲]: “Group” → [SELECT]
- 4 [▼]/[▲]: Select the desired group. → [SELECT]
- 5 [▼]/[▲]: Select the current setting of the group ringer tone. → [SELECT]
- 6 [▼]/[▲]: Select the desired item. → [SAVE]
- 7 Proceed with the operation for your unit.
Base unit: [■] (EXIT)
Handset: [OFF]

Caller list

Important:



- Only 1 person can access the caller list at a time.

Viewing the caller list and calling back

Base unit / Handset

- 1 Proceed with the operation for your unit.
Base unit: [CID]
Handset: [MENU] → [Ⓜ][2][1][3]
- 2 Press [▼] to search from the most recent call, or [▲] to search from the oldest call.
- 3 Proceed with the operation for your unit.
Base unit:
 - To call back, lift the corded handset.
 - To exit, press [■] (EXIT).**Handset:**
 - To call back, press .
 - To exit, press [OFF].

Note:

- In step 2;
 -  and  indicate which line the caller information was received from.
 - If the item has already been viewed or answered, “✓” is displayed, even if it was viewed or answered using another unit.

Caller ID Service

- if an arrow (▶) is displayed after the number, the whole phone number is not shown. Proceed with the operation for your unit.

Base unit:

Press [▶▶] to see the remaining numbers. To return to the previous display, press [◀◀].

Handset:

Press [▶] to see the remaining numbers. To return to the previous display, press [◀].

- In step 3, the unit automatically uses the line you set in line selection mode (page 17) to call back. When the line selection mode is set to “Auto”, the indicated line (L1 or L2) is used for the call. If the indicated line is already being used or you want to select the other line:

Base unit: Press [LINE 1] or [LINE 2], then lift the corded handset.

Handset: Press [CALL], then press [LINE 1] or [LINE 2].

Editing a caller's phone number before calling back

You can edit a phone number in the caller list by removing its area code and/or the long distance code “1”.

Base unit / Handset

- 1 Proceed with the operation for your unit.
Base unit: [CID]
Handset: [MENU] → [⊕][2][1][3]
- 2 [▼]/[▲]: Select the desired entry.
- 3 Proceed with the operation for your unit.
Base unit: [EDIT]
Handset: [CALL]
- 4 Press [EDIT] repeatedly until the phone number is shown in the desired format.

- ① Local phone number

Example:

321-5555

- ② Area code – Local phone number

Example:

555-321-5555

- ③ 1 – Area code – Local phone number

Example:

1-555-321-5555

- 5 Proceed with the operation for your unit.

Base unit: Lift the corded handset.

Handset: [↶]

- If the indicated line is already being used or you want to select the other line:

Base unit: Press [LINE 1] or [LINE 2], then lift the corded handset.

Handset: Press [LINE 1] or [LINE 2].

Caller ID number auto edit feature

Once you call back an edited number, the unit remembers the Area Code and Format of the Edited Number. Next time when someone calls from the same Area Code, caller information is customized by the unit as follows:

- When the call is being received, the Caller ID number is displayed in the same Format as the Edited Number.
- After the call is ended, the phone number of the caller, when reviewed from the Caller list, is displayed in the same Format as the Edited Number.

For example, you can use this feature to set the unit to ignore the area code of callers in your area code, so that you can call these local numbers using caller information without dialing the area code.

To activate this feature, you must edit an item in the caller list, then call that number. After that, phone numbers from that caller's area code are edited automatically.

This feature can be turned on or off (page 28).

Note:

- Phone numbers from the 4 most recently edited area codes are automatically edited.
- If you move to another area, you can turn this feature off to erase previously edited area codes. To use this feature again, turn it on and reprogram the area codes you want to edit once again.

Erasing selected caller information

Base unit / Handset

- 1 Proceed with the operation for your unit.
Base unit: [CID]
Handset: [MENU] → [⊕][2][1][3]
- 2 [▼]/[▲]: Select the desired entry.
- 3 [ERASE]

- 4 **[▼]/[▲]: "yes" → [SELECT]**
- 5 Proceed with the operation for your unit.
Base unit: [■] (EXIT)
Handset: [OFF]

Erasing all caller information

Base unit / Handset

- 1 Proceed with the operation for your unit.
Base unit: [CID]
Handset: [MENU] → [≡][2][1][3]
- 2 **[ERASE]**
- 3 **[▼]/[▲]: "yes" → [SELECT]**
- 4 Proceed with the operation for your unit.
Base unit: [■] (EXIT)
Handset: [OFF]

Storing caller information into the phonebook

Base unit

- 1 **[CID]**
- 2 **[▼]/[▲]:** Select the desired entry.
 - To edit the number, press **[EDIT]** repeatedly until the phone number is shown in the desired format.
- 3 **[SAVE]**
- 4 If necessary, edit the party's name (16 characters max.). → **[OK]**
- 5 If necessary, edit the party's phone number (24 digits max.). → **[OK]**
- 6 **[▼]/[▲]:** Select the desired group (page 22). → **[SELECT]** 2 times
 - To add other entries, repeat from step 2.
- 7 **[■] (EXIT)**

Handset

- 1 **[MENU] → [≡][2][1][3]**
- 2 **[▼]/[▲]:** Select the desired entry.
 - To edit the number, press **[SAVE]**. → Press **[EDIT]** repeatedly until the phone number is shown in the desired format. → **[SAVE]** → Go to step 4.
- 3 Press **[SAVE]** 2 times.
- 4 If necessary, edit the party's name (16 characters max.). → **[OK]**

- 5 If necessary, edit the party's phone number (24 digits max.). → **[OK]**
- 6 **[▼]/[▲]:** Select the desired group (page 22). → **[SELECT]** 2 times
 - To add other entries, repeat from step 2.
- 7 **[OFF]**

Answering system

The answering system can answer and record calls for you when you are unavailable to answer the phone.

Important:

- Only 1 person can access the answering system (listen to messages, record a greeting message, etc.) at a time.
- When callers leave messages, the unit records the day and time of each message. Make sure the date and time have been correctly set (page 17).

Memory capacity

The total recording capacity (including your greeting message) is about 40 minutes. A maximum of 64 messages can be recorded.

Note:

- If message memory becomes full, the ANSWER ON indicator on the base unit flashes rapidly.
- When the message memory becomes full:
 - If you use the pre-recorded greeting message, the unit automatically switches to another pre-recorded greeting message asking callers to call again later.
 - If you recorded your own greeting message, the same message is still announced to callers even though their messages are not recorded.

Turning the answering system on/off

Base unit

■ To turn on:

Press **[ANSWER SELECT]** repeatedly to select the desired line(s). → **[ANSWER ON]**

- The ANSWER ON indicator lights up.

■ To turn off:

Press **[ANSWER ON]**.

- The ANSWER ON indicator turns off.

Call screening

Base unit / Handset

While a caller is leaving a message, you can listen to the call through the base unit's or handset's speaker. To adjust the speaker volume, press **[▲]** or **[▼]** repeatedly.

You can answer the call by lifting the corded handset from the base unit or pressing **[📞]** on the handset.

Note:

- To turn this feature off, see page 41.

Greeting message

When the unit answers a call, callers are greeted by a greeting message. You can record your own greeting message or use a pre-recorded greeting message.

Recording your greeting message

Greeting messages can be recorded in one of the two following ways:

- for line 1 and line 2 with different greetings (2 minutes max. for each greeting)
- for line 1 and line 2 with the same greeting (2 minutes max.). Select “Line1&Line2” in step 2.

Base unit

- 1 **[MENU]** → **[#][3][0][2]**
- 2 **[▼]/[▲]**: Select the desired line(s). → **[SELECT]**
- 3 After the base unit beeps, speak clearly about 20 cm (8 inches) away from the MIC.
- 4 Press **[STOP]** to stop recording.
 - The message you have recorded is played after the beep.
- 5 **[■]** (EXIT)

Using a pre-recorded greeting message

If you erase or do not record your own greeting message, the unit plays a pre-recorded greeting message for callers and asks them to leave messages.

Playing back the greeting message

Base unit

- 1 **[MENU]** → **[⇄][3][0][3]**
- 2 **[▼]/[▲]**: Select the desired line(s). → **[SELECT]**
- 3 **[■]** (EXIT)

Erasing your greeting message

If you erase your own greeting message, the unit plays a pre-recorded greeting message for callers.

Base unit

- 1 **[MENU]** → **[⇄][3][0][3]**
- 2 **[▼]/[▲]**: Select the desired line(s). → **[SELECT]**
- 3 Press **[ERASE]** while your greeting message is playing.
- 4 **[■]** (EXIT)

Listening to messages using the base unit

When new messages have been recorded, the message indicator on the base unit flashes. Press **[▶]**.

- If new messages have been recorded, the base unit plays back new messages.
- If there are no new messages, the base unit plays back all messages.

Playing back messages for the desired line(s)

Press **[ANSWER SELECT]** repeatedly to select the desired line(s), then press **[▶]**.

Operating the answering system

Key	Operation
[▲] or [▼]	Adjust the speaker volume
[◀◀]	Repeat message (during playback) ^{*1}
[▶▶]	Skip message (during playback)

Key	Operation
[PAUSE]	Pause message To resume playback, press [▶] .
[■] (STOP)	Stop playback To exit the playback mode, press [■] (EXIT).
[ERASE]	Erase currently playing message

*1 If pressed within the first 5 seconds of a message, the previous message is played.

Calling back (Caller ID subscribers only)

If caller information was received for the call, you can call the caller back while listening to a message.

- 1 Press **[EDIT]** during playback.
 - To edit the number before calling back, press **[EDIT]** repeatedly until the phone number is shown in the desired format (page 34).
- 2 Lift the corded handset.
 - The unit automatically uses the line you set in line selection mode (page 17) to call back. When the line selection mode is set to "Auto", the indicated line (**[L1]** or **[L2]**) is used for the call. If the indicated line is already being used or you want to select the other line, press **[LINE 1]** or **[LINE 2]**, then lift the corded handset.

Erasing all messages

Erasing all messages for both line 1 and line 2

- 1 **[ERASE]**
 - **[LINE1]** and **[LINE2]** are displayed.
- 2 Press **[ERASE]** again.

Erasing all messages for the desired line(s)

Press **[ANSWER SELECT]** repeatedly to select the desired line(s), then press **[ERASE]** 2 times.

Listening to messages using the handset

When new messages have been recorded, “New message” is displayed.

- To play new messages:
[MENU] → [⇄][3][2][3]
 To play all messages:
[MENU] → [⇄][3][2][4]

- When finished, press **[OFF]**.

Note:

- To switch to the receiver, press **[↶]**.

Playing back messages for the desired line(s)

- [MENU] → [▼]/[▲]: “Answering device” → [SELECT]**
- Press **[⇄]** repeatedly to select the desired line(s).
- [▼]/[▲]: “Play new msg.” or “Play all msg.” → [SELECT]**
- When finished, press **[OFF]**.

Operating the answering system

You can also operate the answering system by pressing dial keys on the handset.

To use the following commands:

- [MENU] → [▼]/[▲]: “Answering device” → [SELECT]** → Press **[⇄]** repeatedly to select the desired line(s) if necessary.

Key	Operation
[▲] or [▼]	Adjust the receiver/speaker volume
[1] or [←]	Repeat message (during playback) ^{*1}
[2] or [→]	Skip message (during playback)
[3]	Enter the “Settings” menu
[4]	Play new messages
[5]	Play all messages
[PAUSE]	Pause message ^{*2}
[9]	Stop playback
[0]	Turn answering system off
[✖][4]	Erase currently playing message

Key	Operation
[✖][5]	Erase all messages
[⇄][1] → [8]^{*3}	Turn answering system on for line 1 only
[⇄][2] → [8]^{*3}	Turn answering system on for line 2 only
[⇄][0] → [8]^{*3}	Turn answering system on for both line 1 and line 2

*1 If pressed within the first 5 seconds of a message, the previous message is played.

*2 To resume playback:

[▼]/[▲]: “Playback” → [SELECT]

*3 For English voice guidance only:

When you press a line selection number (**[⇄][1]**, **[⇄][2]**, or **[⇄][0]**), the selected line(s) is announced, then press **[8]**.

Calling back (Caller ID subscribers only)

If caller information was received for the call, you can call the caller back while listening to a message.

- Press **[MENU]** during playback.
- [▼]/[▲]: “Edit & Call” → [SELECT]**
 - To edit the number before calling back, press **[EDIT]** repeatedly until the phone number is shown in the desired format (page 34).

3 [↶]

- The unit automatically uses the line you set in line selection mode (page 17) to call back. When the line selection mode is set to “Auto”, the indicated line (**[L1]** or **[L2]**) is used for the call. If the indicated line is already being used or you want to select the other line, press **[LINE 1]** or **[LINE 2]**.

Erasing all messages

Erasing all messages for both line 1 and line 2

- [MENU] → [⇄][3][2][5]**
- [▼]/[▲]: “Yes” → [SELECT]**
- [OFF]**

Erasing all messages for the desired line(s)

- 1 **[MENU]** → **[▼]/[▲]**: “Answering device” → **[SELECT]**
- 2 Press **[OK]** repeatedly to select the desired line(s).
- 3 **[▼]/[▲]**: “Erase all” → **[SELECT]**
- 4 **[▼]/[▲]**: “Yes” → **[SELECT]**
- 5 **[OFF]**

Remote operation

Using a touch-tone phone, you can call your phone number from outside and access the unit to listen to messages or change answering system settings. The unit’s voice guidance prompts you to press certain dial keys to perform different operations.

Remote access code

A 3-digit remote access code must be entered when operating the answering system remotely. This code prevents unauthorized parties from listening to your messages remotely. The default setting is “111”.

Program this setting using either the base unit or one of the handsets.

 Base unit /  Handset

- 1 **[MENU]** → **[#][3][0][6]**
- 2 Enter the desired 3-digit remote access code. → **[SAVE]**
- 3 Proceed with the operation for your unit.
Base unit: **[■]** (EXIT)
Handset: **[OFF]**

Using the answering system remotely

- 1 Dial your phone number from a touch-tone phone.
- 2 After the greeting message starts, enter your remote access code.
 - The unit will announce the number of new messages.
 - The voice guidance announcements are different depending on the voice guidance language setting (page 16).
- 3 Follow the voice guidance prompts as necessary or control the unit using remote commands (page 40).
- 4 When finished, hang up.

Voice guidance

When the English voice guidance is selected

During remote operation, the unit’s voice guidance starts and prompts you to press **[1]** to perform a specific operation, or press **[2]** to listen to more available operations. Operations are presented by voice guidance in the following order:

- Play back all messages
- Play back new messages
- Record your message
- Erase all messages
- Record your greeting message

Note:

- If you do not press any dial keys within 10 seconds after a voice guidance prompt, the unit disconnects your call.

When the Spanish voice guidance is selected

To start the voice guidance, press **[9]**. The voice guidance announces the available remote commands (page 40). See the Spanish quick guide for details.

Note:

- If you do not press any dial keys within 10 seconds after a voice guidance prompt, the unit disconnects your call.

Remote commands

You can press dial keys to access certain answering system functions without waiting for the voice guidance to prompt you.

- 1 Select the desired line(s) while you are accessing the answering system if necessary.
For line 1: **[#][1]**
For line 2: **[#][2]**
For line 1 and line 2: **[#][0]**
- 2 Press the desired dial keys.

Key	Operation
[1]	Repeat message (during playback) ^{*1}
[2]	Skip message (during playback)
[4]	Play new messages
[5]	Play all messages
[6]	Play greeting message
[#][1][7]	Record a greeting message for line 1 only
[#][2][7]	Record a greeting message for line 2 only
[#][0][7]	Record a common greeting message for both line 1 and line 2
[#][1][8]	Turn answering system on for line 1 only
[#][2][8]	Turn answering system on for line 2 only
[#][0][8]	Turn answering system on for both line 1 and line 2
[9]	Stop recording Stop playback ^{*2} Start voice guidance ^{*3}
[0]	Turn answering system off
[*][4]	Erase currently playing message
[*][5]	Erase all messages
[*][6]	Erase greeting message (during greeting message playback)
[*][#]	End remote operation (or hang up)

*1 If pressed within the first 5 seconds of a message, the previous message is played.

*2 For English voice guidance only:
To resume operation, enter a remote command within 3 seconds, or the voice guidance starts.

*3 For Spanish voice guidance only

Turning on the answering system remotely

If the answering system is turned off, you can turn it on remotely.

Important:

- The answering system can be remotely turned on only for the line which you have currently selected in "Turning the answering system on/off", page 36.

- 1 Dial your phone number.
- 2 Let the phone ring 15 times.
- 3 Enter your remote access code after the beep.
 - The greeting message is played back.
 - You can either hang up, or from a touch-tone phone you can enter your remote access code and begin remote operation (page 39).

Note:

- If you want to turn on the answering system for the line which has not been selected in "Turning the answering system on/off", page 36, enter the desired remote commands, **[#][1][8]**, **[#][2][8]**, or **[#][0][8]** (refer to the column to the left) to turn on and access the other line.

Skipping the greeting message to leave a message

You can leave a message just as any outside caller can. Call your phone number from a touch-tone phone. When the answering system picks up, press **[*]** to skip the greeting message and record your message after the beep.

Answering system settings

Number of rings before the unit answers calls

You can change the number of times the phone rings “**Ring count**” before the unit answers calls. You can select 2 to 7 rings, or “**To11 saver**”.

The default setting is “4”.

“**To11 saver**”: The unit’s answering system answers at the end of the 2nd ring when new messages have been recorded, or at the end of the 4th ring when there are no new messages. If you call your phone from outside to listen to new messages (page 39), you will know that there are no new messages when the phone rings for the 3rd time. You can then hang up without being charged for the call.

Program this setting using either the base unit or one of the handsets.

 Base unit /  Handset

- 1 **[MENU]** → **[#][2][1][1]**
- 2 **[▼]/[▲]**: Select the desired setting. → **[SAVE]**
- 3 Proceed with the operation for your unit.
Base unit: **[■]** (EXIT)
Handset: **[OFF]**

For voice mail service subscribers

If you subscribe to a flat-rate service package that includes Caller ID, call waiting, voice mail, and unlimited local/regional/long distance calls, please note the following:

- To use the voice mail service provided by your service provider/telephone company rather than the unit’s answering system, turn off the answering system (page 36).
- To use this unit’s answering system rather than the voice mail service provided by your service provider/telephone company, please contact your service provider/telephone company to deactivate your voice mail service.

If your service provider/telephone company cannot do this:

- Set this unit’s “**Ring count**” setting so that this unit’s answering system answers calls before the voice mail service of your service

provider/telephone company does. It is necessary to check the number of rings required to activate the voice mail service provided by your service provider/telephone company before changing this setting.

- Change the number of rings of the voice mail service so that the answering system can answer the call first. To do so, contact your service provider/telephone company.

Caller’s recording time

You can change the maximum message recording time allotted to each caller. The default setting is “3min”.

Program this setting using either the base unit or one of the handsets.

 Base unit /  Handset

- 1 **[MENU]** → **[#][3][0][5]**
- 2 **[▼]/[▲]**: Select the desired setting. → **[SAVE]**
- 3 Proceed with the operation for your unit.
Base unit: **[■]** (EXIT)
Handset: **[OFF]**

Turning the call screening on/off

You can set the call screening feature “on” or “off”. For details, see page 36. The default setting is “on”.

 Base unit /  Handset

- 1 **[MENU]** → **[#][3][1][0]**
- 2 **[▼]/[▲]**: Select the desired setting. → **[SAVE]**
- 3 Proceed with the operation for your unit.
Base unit: **[■]** (EXIT)
Handset: **[OFF]**

Voice mail service

Voice mail is an automatic answering service offered by your service provider/telephone company. After you subscribe to this service, your service provider/telephone company's voice mail system answers calls for you when you are unavailable to answer the phone or when your line is busy. Messages are recorded by your service provider/telephone company, not your telephone. Please contact your service provider/telephone company for details of this service.

Important:

- To use the voice mail service provided by your service provider/telephone company rather than the unit's answering system, turn off the answering system (page 36). For details, see page 41.

Voice Mail message indication

The unit lets you know that you have new voice mail messages by showing "VoiceMail:Line1" and/or "VoiceMail:Line2" on the display. To listen to your voice mail messages, you must dial your service provider/telephone company's voice mail access number.

Note:

- If the base unit or handset still indicates there are new messages even after you have listened to all new messages, turn it off by pressing and holding **[OFF]** on the handset until a beep sounds.
- If your voice mail service uses voice mail tones and the message is over 3 minutes long, the unit may not indicate new messages.

Voice mail (VM) tone detection

Your service provider/telephone company sends special signals (sometimes called "voice mail tones" or "stutter tones") to the unit to let you know you have new voice mail messages. If you hear a series of dial tones followed by a continuous dial tone after you lift the corded handset or press **[📞]**, you have new voice mail messages. Minutes after you hang up a call or after the phone stops ringing, your unit checks the phone line to see if new voice mail messages have been recorded.

Turn this feature off when:

- You do not subscribe to voice mail service.
- Your service provider/telephone company does not send voice mail tones.
- Your phone is connected to a PBX.

If you are not sure which setting is required, contact your service provider/telephone company.

Turning VM tone detection on/off

The default setting is "On".

Program this setting using either the base unit or one of the handsets.

Base unit / Handset

- 1 **[MENU]** → **[#][3][3][2]**
- 2 **[▼]/[▲]**: Select the desired setting. → **[SAVE]**
- 3 Proceed with the operation for your unit.
Base unit: **[■]** (EXIT)
Handset: **[OFF]**

Intercom

Intercom calls can be made:

- between the base unit and handset.
- between handsets.

Note:

- When paging unit(s) for an intercom call, the paged unit(s) beeps for 1 minute.
- If you receive an outside call while talking on the intercom, an interrupt tone will be heard (page 28).
 - To answer the call with the base unit, place the corded handset on the cradle, then lift it again. If the speakerphone is used, press **[SP-PHONE]** 2 times. You can also answer the call by pressing **[LINE 1]** or **[LINE 2]** after hanging up the intercom.
 - To answer the call with the handset, press **[OFF]**, then press **[↶]**.

Making an intercom call

Base unit

- 1 **[INTERCOM]**
 - Lift the corded handset if needed.
 - When only 1 handset is registered, the base unit pages the handset automatically.
- 2 To page a specific handset, enter the handset number.
To page all handsets, press **[0]** or wait for a few seconds.
 - To stop paging, press **[INTERCOM]**.
- 3 When you finish talking, press **[INTERCOM]** or place the corded handset on the cradle.

Handset

- 1 **[INTERCOM]**
- 2 To page the base unit, press **[0]**.
To page another handset, enter its extension number.
 - To stop paging, press **[OFF]**.
- 3 When you finish talking, press **[OFF]**.

Answering an intercom call

Base unit

- 1 Lift the corded handset or press **[INTERCOM]** to answer the page.
- 2 When you finish talking, place the corded handset on the cradle or press **[INTERCOM]**.

Handset

- 1 Press **[↶]** to answer the page.
- 2 When you finish talking, press **[OFF]**.

Note for base unit and handset:

- The ringer volume for intercom calls follows the higher volume level of the 2 lines (page 29). Even when the ringer volume for both lines is set to off (page 29), the base unit and/or handset still rings at a low level for intercom calls.

Transferring calls

Outside calls can be transferred between 2 people.

Base unit

- 1 During an outside call, press **[INTERCOM]** to put the call on hold.
 - When only 1 handset is registered, the base unit pages the handset automatically.
- 2 To page a specific handset, enter the extension number.
To page all handsets, press **[0]** or wait for a few seconds.
- 3 Wait for the paged party to answer.
 - If the paged party does not answer, press the flashing **[LINE 1]** or **[LINE 2]** to return to the outside call.
- 4 Place the corded handset on the cradle or press **[INTERCOM]**.
 - The outside call is being routed to the handset.

Handset

- 1 During an outside call, press **[INTERCOM]** once to put the call on hold.

Intercom/Locator

- To page the base unit, press **[0]**.
To page another handset, enter its extension number.
- Wait for the paged party to answer.
 - If the paged party does not answer, press **[LINE 1]** or **[LINE 2]** that is flashing on the handset to return to the outside call.
- [OFF]**
 - The outside call is being routed to the destination unit.

Answering a transferred call

Base unit

Lift the corded handset or press **[SP-PHONE]** to answer the page.

Handset

Press **[↶]** to answer the page.

Note for base unit and handset:

- After the paging party disconnects, you can talk to the outside caller.

Conference calls

3 people can establish a conference call.

Conference call with 2 outside calls

While you are talking with an outside caller, you can make or answer a 2nd call on the other line, and then combine the calls to establish a conference call.

Base unit

- During an outside call, press **[HOLD]**.
- To answer a 2nd call, press **[LINE 1]** or **[LINE 2]**.
To make a 2nd call, press **[LINE 1]** or **[LINE 2]**, then dial the phone number.
- When the 2nd call is connected, press **[MENU]**. → **[▼]/[▲]**: “Conference” → **[SELECT]**
 - The 2 calls are combined.
 - To hang up only one line, press **[LINE 1]** or **[LINE 2]** for the party with which you want to continue talking.

- To put both lines on hold, press **[HOLD]**. To talk with only one caller, press **[LINE 1]** or **[LINE 2]** for the party with which you want to continue talking. To resume both lines, press **[CONF]**.

Handset

- During an outside call, press **[HOLD]** 2 times.
- To answer a 2nd call, press **[LINE 1]** or **[LINE 2]**.
To make a 2nd call, press **[LINE 1]** or **[LINE 2]**, then dial the phone number.
- When the 2nd call is connected, press **[MENU]**. → **[▼]/[▲]**: “Conference” → **[SELECT]**
 - The 2 calls are combined.
 - To hang up only one line, press **[LINE 1]** or **[LINE 2]** for the party with which you want to continue talking.
 - To put both lines on hold, press **[HOLD]**. To talk with only one caller, press **[LINE 1]** or **[LINE 2]** for the party with which you want to continue talking. To resume both lines, press **[CONF]**.

Conference call with an outside call and an intercom call

While you are talking with an outside caller, one more extension can join the conversation and establish a conference call.

Base unit

- During an outside call, press **[INTERCOM]** to put the call on hold.
 - When only 1 handset is registered, the base unit pages the handset automatically.
- To page a specific handset, enter its extension number.
To page all handsets, press **[0]** or wait for a few seconds.
- When the paged party answers, press **[CONF]**.
 - The 2 calls are combined.
 - To leave the conference, place the corded handset on the cradle or press **[SP-PHONE]**. The other 2 parties can continue the conversation.

Handset

- 1 During an outside call, press **[INTERCOM]** once to put the call on hold.
- 2 To page the base unit, press **[0]**.
To page another handset, enter its extension number.
- 3 When the paged party answers, press **[CONF]**.
 - The 2 calls are combined.
 - To leave the conference, press **[OFF]**. The other 2 parties can continue the conversation.

Note for the base unit and handset:

- The outside call can be put on hold by pressing **[HOLD]**. Only the person who placed the call on hold can resume the full conference by pressing **[CONF]**.

Handset locator

You can locate a misplaced handset by paging it.

- 1 **Base unit:**
[LOCATOR]
 - All registered handsets beep for 1 minute.
- 2 To stop paging:
Base unit:
Press **[LOCATOR]**.
Handset:
Press **[INTERCOM]**, then press **[OFF]**.

Note:

- Even when the ringer volume for both lines is set to off (page 29), the handset still rings at a low level for paging.

Wall mounting for charger

- 1 Drive the screws (not supplied) into the wall.

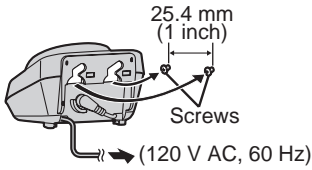

- 2 Mount the charger (1), then slide it down (2) and to the right (3) until it is secure.

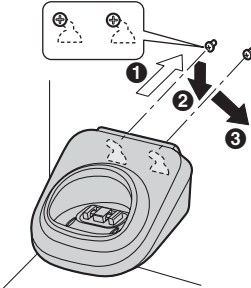

Belt clip

You can hang the handset on your belt or pocket using the supplied belt clip.

To attach the belt clip

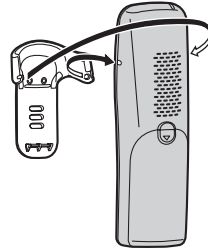

To remove the belt clip



Headset (optional)

Connecting a headset to the handset allows for hands-free conversations. We recommend using the Panasonic headset noted on page 4.

Error messages

If the unit detects a problem, one of the following messages is shown on the display.

Display message	Cause/solution
Busy	<ul style="list-style-type: none"> • The called handset or base unit is in use. • Other units are in use and the system is busy. Try again later. • Privacy mode is on for the call you tried to join (page 21). • The handset you are using is too far from the base unit. Move closer and try again. • The handset's registration may have been canceled. Re-register the handset (page 32).
Check tel line 1 Check tel line 2	<ul style="list-style-type: none"> • The supplied telephone line cord has not been connected yet or not connected properly. Check the connections (page 13). • If you use the unit as a single-line telephone only, erase the message as follows: To erase "Check tel line 1", press [MENU]. → [#][1][8][9] To erase "Check tel line 2", press [MENU]. → [#][1][9][0] When a power failure occurs, the message is displayed again. Erase again as above.
Error!!	<ul style="list-style-type: none"> • The handset's registration has failed. Move the base unit and handset away from all electrical appliances and try again. • Recording was too short. Try again.
Failed	<ul style="list-style-type: none"> • Phonebook copy failed (page 24). Confirm the other unit (the receiver) is in standby mode and try again.
Incomplete	<ul style="list-style-type: none"> • Phonebook copy is incomplete. The receiver's phonebook memory is full. Erase the unnecessary phonebook entries (page 23) from the other unit (the receiver) and try again.
Memory full	<ul style="list-style-type: none"> • The phonebook memory is full. Erase unnecessary entries (page 23). • Message memory is full. Erase unnecessary messages (page 37, 38).
Messages full	<ul style="list-style-type: none"> • Message memory is full. Erase unnecessary messages (page 37, 38).
No link to base. Reconnect AC adaptor.	<ul style="list-style-type: none"> • The handset has lost communication with the base unit. Move closer to the base unit and try again. • Unplug the base unit's AC adaptor to reset the unit. Reconnect the adaptor and try again. • The handset's registration may have been canceled. Re-register the handset (page 32).
Use rechargeable battery.	<ul style="list-style-type: none"> • A wrong type of batteries such as Alkaline or Manganese was inserted. Use only the rechargeable Ni-MH batteries noted on page 4, 15.
You must first subscribe to Caller ID.	<ul style="list-style-type: none"> • You must subscribe to Caller ID service. Once you receive caller information after subscribing to Caller ID service, this message will not be displayed.

Troubleshooting

If you still have difficulties after following the instructions in this section, disconnect the base unit's AC adaptor, then reconnect the base unit's AC adaptor. Remove the batteries from the handset, and then insert the batteries into the handset again.



General use

Problem	Cause/solution
The unit does not work.	<ul style="list-style-type: none">● Make sure the batteries are installed correctly (page 15).● Fully charge the batteries (page 15).● Check the connections (page 12).● Unplug the base unit's AC adaptor to reset the unit. Reconnect the adaptor and try again.● The handset has not been registered to the base unit. Register the handset (page 32).
I cannot hear a dial tone.	<ul style="list-style-type: none">● The base unit's AC adaptor or telephone line cord is not connected. Check the connections.● If you are using a splitter to connect the unit, remove the splitter and connect the unit to the wall jack directly. If the unit operates properly, check the splitter.● Disconnect the base unit from the telephone line and connect the line to a known working telephone. If the working telephone operates properly, contact our service personnel to have the unit repaired. If the working telephone does not operate properly, contact your service provider/telephone company.
🔊 is flashing.	<ul style="list-style-type: none">● The handset has not been registered to the base unit. Register the handset (page 32).● The handset is too far from the base unit. Move closer.● The base unit's AC adaptor is not connected. Check the connections.● You are using the base unit or handset in an area with high electrical interference. Re-position the base unit and use the handset away from interference sources.

Programmable settings

Problem	Cause/solution
I have changed the display language to a language I cannot read.	<ul style="list-style-type: none">● Change the display language (page 16).
While programming, the unit starts to ring.	<ul style="list-style-type: none">● A call is being received. Answer the call and start again after hanging up.
I cannot register a handset to a base unit.	<ul style="list-style-type: none">● The maximum number of handsets (6) is already registered to the base unit. Cancel unused handset registrations from the base unit (page 32).● Place the handset and the base unit away from other electrical appliances.

Battery recharge

Problem	Cause/solution
The handset beeps and/or  flashes.	<ul style="list-style-type: none"> ● Battery charge is low. Fully charge the batteries (page 15).
I fully charged the batteries, but  still flashes or  is displayed.	<ul style="list-style-type: none"> ● Clean the charge contacts and charge again (page 16). ● It is time to replace the batteries (page 15).
I fully charged the batteries, but the operating time seems to be shorter.	<ul style="list-style-type: none"> ● Clean the battery ends (\oplus, \ominus) and the charge contacts with a dry cloth, and charge again.

Making/answering calls, intercom

Problem	Cause/solution
Noise is heard, sound cuts in and out.	<ul style="list-style-type: none"> ● You are using the base unit or handset in an area with high electrical interference. Re-position the base unit and use the handset away from sources of interference. ● Move closer to the base unit. ● If you use a DSL/ADSL service, we recommend connecting a DSL/ADSL filter between the base unit and the telephone line jack. Contact your DSL/ADSL provider for details.
The base unit and/or handset does not ring.	<ul style="list-style-type: none"> ● The ringer volume is turned off. Adjust the ringer volume (page 29). ● Night mode is turned on. Turn it off (page 31).
I cannot make a call.	<ul style="list-style-type: none"> ● The dialing mode may be set incorrectly. Change the setting (page 16). ● The handset is too far from the base unit. Move closer and try again.
I cannot make long distance calls.	<ul style="list-style-type: none"> ● Make sure that you have long distance service.

Caller ID

Problem	Cause/solution
Caller information is not displayed.	<ul style="list-style-type: none"> ● You must subscribe to Caller ID service. Contact your service provider/telephone company for details. ● If your unit is connected to any additional telephone equipment such as a Caller ID box or cordless telephone line jack, plug the unit directly into the wall jack. ● If you use a DSL/ADSL service, we recommend connecting a DSL/ADSL filter between the base unit and the telephone line jack. Contact your DSL/ADSL provider for details. ● The name display service may not be available in some areas. Contact your service provider/telephone company for details. ● Other telephone equipment may be interfering with this unit. Disconnect the other equipment and try again.

Useful Information

Problem	Cause/solution
Caller information is displayed late.	<ul style="list-style-type: none"> Depending on your service provider/telephone company, the unit may display the caller's information at 2nd ring or later. Move closer to the base unit.
The caller list/incoming phone numbers are not edited automatically.	<ul style="list-style-type: none"> The Caller ID number auto edit feature is turned off. Turn it on and try again (page 28). You need to call back the edited number to activate Caller ID number auto edit.
I cannot dial the phone number edited in the caller list.	<ul style="list-style-type: none"> The phone number you dialed might have been edited incorrectly (for example, the long distance "1" or the area code is missing). Edit the phone number with another pattern (page 34).
Time on the unit is shifted.	<ul style="list-style-type: none"> Incorrect time information from incoming Caller ID changes the time. Set the time adjustment to "Manual" (off) (page 29).
The 2nd caller's information is not displayed during an outside call.	<ul style="list-style-type: none"> In order to use Caller ID, call waiting, or Call Waiting Caller ID (CWID), you must first contact your service provider/telephone company and subscribe to the desired service. After subscribing, you may need to contact your service provider/telephone company again to activate this specific service, even if you already subscribed to both Caller ID and Call Waiting with Caller ID services (CWID).

Answering system

Problem	Cause/solution
The unit does not record new messages.	<ul style="list-style-type: none"> The answering system is not turned on for the line you wish to record messages from. Select the desired line or both lines, then turn the answering system on (page 36). The message memory is full. Erase unnecessary messages (page 37). The answering system is activated for both lines, and the 1st caller is leaving a voice message. The 2nd caller cannot leave a message, but the caller information will be stored (page 33). If you subscribe to the voice mail service, messages are recorded by your service provider/telephone company not your telephone. Change the unit's number of rings setting or contact your service provider/telephone company (page 41).
I cannot operate the answering system.	<ul style="list-style-type: none"> Someone is using the unit. Wait for the other user to finish. A caller is leaving a message. Wait for the caller to finish. The handset is too far from the base unit. Move closer.

Problem	Cause/solution
I cannot operate the answering system remotely.	<ul style="list-style-type: none"> • You are entering the wrong remote access code. If you forgot the remote access code, store a new remote access code (page 39). • Press each key firmly. • The answering system is turned off. Turn it on (page 40). • You are using a rotary/pulse telephone. Try again using a touch-tone phone.
While recording a greeting message or listening to messages, the unit rings and recording stops.	<ul style="list-style-type: none"> • A call is being received. Answer the call and try again later.

Liquid damage

Problem	Cause/solution
Liquid or other form of moisture has entered the base unit/handset.	<ul style="list-style-type: none"> • Disconnect the AC adaptor and telephone line cord from the base unit. Remove the batteries from the handset and leave to dry for at least 3 days. After the base unit/handset are completely dry, reconnect the AC adaptor and telephone line cord. Insert the batteries and charge fully before use.

Caution:

- To avoid permanent damage, do not use a microwave oven to speed up the drying process.

FCC and other information

This equipment complies with Part 68 of the FCC rules and the requirements adopted by the ACTA. On the bottom of this equipment is a label that contains, among other information, a product identifier in the format US:ACJ-----.

If requested, this number must be provided to the telephone company.

- Registration No.....(found on the bottom of the unit)
- Ringer Equivalence No. (REN).....0.1B (line 1 and line 2)
- Ringer Equivalence No. (REN: Under a power failure).....1.0B (line 1)

A plug and jack used to connect this equipment to the premises wiring and telephone network must comply with the applicable FCC Part 68 rules and requirements adopted by the ACTA. A compliant telephone cord and modular plug is provided with the product. It is designed to be connected to a compatible modular jack that is also compliant.

The REN is used to determine the number of devices that may be connected to a telephone line. Excessive RENs on a telephone line may result in the devices not ringing in response to an incoming call. In most but not all areas, the sum of RENs should not exceed five (5.0). To be certain of the number of devices that may be connected to a line, as determined by the total RENs, contact the local telephone company. For products approved after July 23, 2001, the REN for the product is part of the product identifier that has the format US:AAAEQ##TXXXX. The digits represented by ## are the REN without a decimal point (e.g., 03 is a REN of 0.3).

If this equipment causes harm to the telephone network, the telephone company will notify you in advance that temporary discontinuance of service may be required. But if advance notice isn't practical, the telephone company will notify the customer as soon as possible. Also, you will be advised of your right to file a complaint with the FCC if you believe it is necessary.

The telephone company may make changes in its facilities, equipment, operations or procedures that could affect the operation of the equipment. If this happens the telephone company will provide advance notice in order for you to make necessary modifications to maintain uninterrupted service.

If trouble is experienced with this equipment, for repair or warranty information, please contact a Factory Service Center or other Authorized Servicer. If the equipment is causing harm to the telephone network, the telephone company may request that you disconnect the equipment until the problem is resolved.

Connection to party line service is subject to state tariffs. Contact the state public utility commission, public service commission or corporation commission for information.

If your home has specially wired alarm equipment connected to the telephone line, ensure the installation of this equipment does not disable your alarm equipment. If you have questions about what will disable alarm equipment, consult your telephone company or a qualified installer.

This equipment is hearing aid compatible as defined by the FCC in 47 CFR Section 68.316.

When you hold the phone to your ear, noise might be heard in your Hearing Aid. Some Hearing Aids are not adequately shielded from external RF (radio frequency) energy. If noise occurs, use an optional headset accessory or the speakerphone option (if applicable) when using this phone. Consult with your audiologist or Hearing Aid manufacturer about the availability of Hearing Aids which provide adequate shielding to RF energy commonly emitted by digital devices.

WHEN PROGRAMMING EMERGENCY NUMBERS AND/OR MAKING TEST CALLS TO EMERGENCY NUMBERS:

- 1) Remain on the line and briefly explain to the dispatcher the reason for the call.

- 2) Perform such activities in the off-peak hours, such as early morning or late evenings.

This device complies with Part 15 of the FCC Rules. Operation is subject to the following two conditions:

(1) This device may not cause harmful interference, and (2) this device must accept any interference received, including interference that may cause undesired operation. Privacy of communications may not be ensured when using this phone.

CAUTION:

Any changes or modifications not expressly approved by the party responsible for compliance could void the user's authority to operate this device.

NOTE:

This equipment has been tested and found to comply with the limits for a Class B digital device, pursuant to Part 15 of the FCC Rules. These limits are designed to provide reasonable protection against harmful interference in a residential installation. This equipment generates, uses, and can radiate radio frequency energy and, if not installed and used in accordance with the instructions, may cause harmful interference to radio communications. However, there is no guarantee that interference will not occur in a particular installation. If this equipment does cause harmful interference to radio or television reception, which can be determined by turning the equipment off and on, the user is encouraged to try to correct the interference by one or more of the following measures:

- Reorient or relocate the receiving antenna.
- Increase the separation between the equipment and receiver.
- Connect the equipment into an outlet on a circuit different from that to which the receiver is connected.
- Consult the dealer or an experienced radio/TV technician for help.

Some cordless telephones operate at frequencies that may cause interference to nearby TVs and VCRs. To minimize or prevent such interference, the base of the cordless telephone should not be placed near or on top of a TV or VCR. If interference is experienced,

move the cordless telephone further away from the TV or VCR. This will often reduce, or eliminate, interference.

FCC RF Exposure Warning:

- This product complies with FCC radiation exposure limits set forth for an uncontrolled environment.
- To comply with FCC RF exposure requirements, the base unit must be installed and operated 20 cm (8 inches) or more between the product and all person's body (excluding extremities of hands, wrist and feet).
- This product may not be collocated or operated in conjunction with any other antenna or transmitter.
- The handset may be carried and operated with only the specific provided belt-clip. Other non-tested belt-clips or similar body-worn accessories may not comply and must be avoided.

Notice:

- FCC ID can be found inside the battery compartment or on the bottom of the units.

Compliance with TIA-1083 standard:

Telephone handsets identified with this logo have reduced noise and interference when used with T-Coil equipped hearing aids and cochlear implants.



Notice

- This product is designed for use in the United States of America. Sale or use of this product in other countries may violate local laws.
- Cet appareil est conçu pour être utilisé aux États-Unis d'Amérique. La vente ou l'emploi de cet appareil dans certains autres pays peut constituer une infraction à la législation locale.
- Este producto está diseñado para usarse en los Estados Unidos de América. La venta o el empleo de este producto en ciertos países puede constituir violación de la legislación local.
- 本產品專為美國使用而設。若在其他國家銷售或使用，可能會違反當地法例。
- この製品は、日本国外での使用を目的として設計されており、日本国内での使用は法律違反となります。従って、当社では日本国内においては原則として修理などのサービスは致しかねます。

ENERGY STAR

As an ENERGY STAR® Participant, Panasonic has determined that this product meets the ENERGY STAR guidelines for energy efficiency. ENERGY STAR is a U.S. registered mark.



Specifications

■ Standard:

DECT 6.0 (Digital Enhanced Cordless
Telecommunications 6.0)

■ Number of channels:

60 Duplex Channels

■ Frequency range:

1.92 GHz to 1.93 GHz

■ Duplex procedure:

TDMA (Time Division Multiple Access)

■ Channel spacing:

1,728 kHz

■ Bit rate:

1,152 kbit/s

■ Modulation:

GFSK (Gaussian Frequency Shift Keying)

■ RF transmission power:

115 mW (max.)

■ Voice coding:

ADPCM 32 kbit/s

■ Power source:

120 V AC, 60 Hz

■ Power consumption:

Base unit:

Standby: Approx. 1.1 W

Maximum: Approx. 2.0 W

Charger:

Standby: Approx. 0.6 W

Maximum: Approx. 3.6 W

■ Operating conditions:

5 °C – 40 °C (41 °F – 104 °F), 20 % – 80 %
relative air humidity (dry)

■ Dimensions:

Base unit: Approx. 127 mm × 216 mm ×
155 mm

(5 inches × 8 ¹/₂ inches × 6 ³/₃₂ inches)

Handset: Approx. 156 mm × 49 mm × 32 mm

(6 ¹/₈ inches × 1 ¹⁵/₁₆ inches × 1 ¹/₄ inches)

Charger: Approx. 51 mm × 75 mm × 88 mm

(2 inches × 2 ¹⁵/₁₆ inches × 3 ¹⁵/₃₂ inches)

■ Mass (weight):

Base unit: Approx. 720 g (1.59 lb)

Handset: Approx. 130 g (0.29 lb)

Charger: Approx. 60 g (0.13 lb)

Note:

- Design and specifications are subject to change without notice.

- The illustrations in these instructions may vary slightly from the actual product.

Customer services

Customer Services Directory

Obtain Product Information and Operating Assistance; locate your nearest Dealer or Service Center; purchase Parts and Accessories; or make Customer Service and Literature requests by visiting our Web Site at:

<http://www.panasonic.com/help>

or, contact us via the web at:

<http://www.panasonic.com/contactinfo>

You may also contact us directly at: 1-800-211-PANA (1-800-211-7262),
Monday - Friday 9 am to 9 pm; Saturday - Sunday 10 am to 7 pm, EST.

TTY users (hearing or speech impaired users) can call 1-877-833-8855.

Accessory Purchases

Purchase Parts, Accessories and Instruction Books online for all Panasonic Products by visiting our Web Site at:

<http://www.pstc.panasonic.com>

or, send your request by E-mail to:

npcparts@us.panasonic.com

You may also contact us directly at:

1-800-332-5368 (Phone) 1-800-237-9080 (Fax Only)

(Monday - Friday 9 am to 9 pm, EST.)

Panasonic Service and Technology Company

20421 84th Avenue South, Kent, WA 98032

(We Accept Visa, MasterCard, Discover Card, American Express, and Personal Checks.)

TTY users (hearing or speech impaired users) can call 1-866-605-1277.

Service in Puerto Rico

Panasonic Puerto Rico, Inc.

San Gabriel Industrial Park, Ave. 65 de Infantería, Km. 9.5,

Carolina, Puerto Rico 00985

Phone (787)750-4300, Fax (787)768-2910

Warranty

PANASONIC CONSUMER
ELECTRONICS COMPANY, DIVISION
OF PANASONIC CORPORATION OF
NORTH AMERICA
One Panasonic Way,
Secaucus, New Jersey 07094

PANASONIC PUERTO RICO, INC.
San Gabriel Industrial Park,
Ave. 65 de Infantería, Km. 9.5,
Carolina, Puerto Rico 00985

Panasonic Telephone Products Limited Warranty

Limited Warranty Coverage

If your product does not work properly because of a defect in materials or workmanship, Panasonic Consumer Electronics Company or Panasonic Puerto Rico, Inc. (collectively referred to as "the warrantor") will, for the length of the period indicated on the chart below, which starts with the date of original purchase ("Limited Warranty period"), at its option either (a) repair your product with new or refurbished parts, or (b) replace it with a new or a refurbished product. The decision to repair or replace will be made by the warrantor.

Parts	Labor
One (1) Year	One (1) Year

During the "Labor" Limited Warranty period there will be no charge for labor. During the "Parts" Limited Warranty period, there will be no charge for parts. You must mail-in your product prepaid during the Limited Warranty period. This Limited Warranty excludes both parts and labor for batteries, antennas, and cosmetic parts (cabinet). This Limited Warranty only applies to products purchased and serviced in the United States or Puerto Rico. This Limited Warranty is extended only to the original purchaser and only covers products purchased as new.

Ship-In Service

For assistance in the continental U.S.A. in obtaining repairs please ship the product prepaid to:

PSTC (Panasonic) Exchange Center,
4900 George McVay Drive, Suite B Door #12, McAllen, TX 78503
panacare@us.panasonic.com

When shipping the unit carefully pack in a padded shipping carton, include all accessories, and send it prepaid. Include a letter detailing the complaint, a return address and provide a day time phone number where you can be reached. P.O. Boxes are not acceptable. Keep the tracking number for your records. A copy of valid registered receipt is required under the 1 year parts and labor Limited Warranty.

For Limited Warranty service for headsets if a headset is included with this product please follow instructions above.

For assistance in Puerto Rico call Panasonic Puerto Rico, Inc. (787)-750-4300 or fax (787)-768-2910.

IF REPAIR IS NEEDED DURING THE LIMITED WARRANTY PERIOD THE PURCHASER WILL BE REQUIRED TO FURNISH A SALES RECEIPT/PROOF OF PURCHASE INDICATING DATE OF PURCHASE, AMOUNT PAID AND PLACE OF PURCHASE. CUSTOMER WILL BE CHARGED FOR THE REPAIR OF ANY UNIT RECEIVED WITHOUT SUCH PROOF OF PURCHASE.

Limited Warranty Limits And Exclusions

This Limited Warranty ONLY COVERS failures due to defects in materials or workmanship, and DOES NOT COVER normal wear and tear or cosmetic damage. The Limited Warranty ALSO DOES NOT COVER damages which occurred in shipment, or failures which are caused by products not supplied by the warrantor, or failures which result from accidents, misuse, abuse, neglect, bug infestation, mishandling, misapplication, alteration, faulty installation, set-up adjustments, misadjustment of consumer controls, improper maintenance, power line surge, lightning damage, modification, introduction of sand, humidity or liquids, commercial use such as hotel, office, restaurant, or other business or rental use of the product, or service by anyone other than a Factory Service Center or other Authorized Servicer, or damage that is attributable to acts of God.

THERE ARE NO EXPRESS WARRANTIES EXCEPT AS LISTED UNDER "LIMITED WARRANTY COVERAGE". THE WARRANTOR IS NOT LIABLE FOR INCIDENTAL OR CONSEQUENTIAL DAMAGES RESULTING FROM THE USE OF THIS PRODUCT, OR ARISING OUT OF ANY BREACH OF THIS LIMITED WARRANTY. (As examples, this excludes damages for lost time, lost calls or messages, cost of having someone remove or re-install an installed unit if applicable, travel to and from the servicer. The items listed are not exclusive, but are for illustration only.) **ALL EXPRESS AND IMPLIED WARRANTIES, INCLUDING THE WARRANTY OF MERCHANTABILITY, ARE LIMITED TO THE PERIOD OF THE LIMITED WARRANTY.**

Some states do not allow the exclusion or limitation of incidental or consequential damages, or limitations on how long an implied warranty lasts, so the exclusions may not apply to you. This Limited Warranty gives you specific legal rights and you may also have other rights which vary from state to state. If a problem with this product develops during or after the Limited Warranty period, you may contact your dealer or Service Center. If the problem is not handled to your satisfaction, then write to the warrantor's Consumer Affairs Department at the addresses listed for the warrantor.

PARTS AND SERVICE, WHICH ARE NOT COVERED BY THIS LIMITED WARRANTY, ARE YOUR RESPONSIBILITY.

Index

- A** Additional handset: 32
 Alarm: 31
 Answering calls
 Base unit: 19
 Handset: 19
 Answering system
 Call screening: 36
 Erasing messages: 37, 38, 40
 Listening to messages: 37, 38, 39
 Memory capacity: 36
 Number of rings: 41
 Recording time: 41
 Remote access code: 39
 Remote operation: 39
 Ring count: 41
 Toll saver: 41
 Turning on/off: 36, 40
 Auto talk: 19
- B** Battery: 15
 Belt clip: 46
- C** Caller ID number auto edit: 34
 Caller ID service: 33
 Caller list
 Calling back: 33
 Editing: 34
 Erasing: 34, 35
 Storing: 35
 Viewing: 33
 Call privacy: 21
 Call share: 21
 Call waiting: 20
 Call Waiting Caller ID: 20
 Check tel line 1: 47
 Check tel line 2: 13, 47
 CID (Caller ID): 33
 Conference calls: 44
 Customer support: 31
- D** Date and time: 17
 Dialing mode: 16
 Direct commands: 28
 Display
 Contrast: 28
 Language: 16
- E** Error messages: 47
- F** Flash: 20, 29
- G** Greeting message: 36
 Group ringer tone: 33
- H** Handset
 Deregistration: 32
 Locator: 45
 Registration: 32
 Headset, optional: 46
 Hold: 20
- I** Intercom: 43
 Interrupt tone: 28
- K** Key tone: 28
- L** Line mode: 29
 Line selection mode: 17
- M** Making calls
 Base unit: 18
 Handset: 18
 Memory full: 23, 37, 38, 47
 Menu icons: 11
 Messages full: 36, 37, 38, 47
 Missed calls: 33
 Mute: 20
- N** Night mode: 31
- P** Pause: 18
 Phonebook
 Adding: 22
 Chain dial: 24
 Copying: 24
 Editing: 23
 Erasing: 23
 Group: 22
 Power failure: 12, 13, 47
 Programmable settings: 25
- R** Redialing: 18
 Ringer tone: 29
 Rotary/pulse service: 20
- S** SP-PHONE (Speakerphone): 18
- T** Time adjustment: 29
 Transferring calls: 43
 Troubleshooting: 48
 TTY: 5, 56
- V** VM (Voice mail): 42
 Voice guidance language: 16
 Voice mail: 41, 42
 Volume
 Receiver: 10, 18
 Ringer (Base unit): 19, 29
 Ringer (Handset): 19, 29
 Speaker: 10, 18
- W** Wall mounting: 46

