

# Robustel GoRugged M1000

## Smart Cellular Modem

### For GSM/GPRS/EDGE Networks

## User Guide

Document Name:	<b>User Guide</b>
Firmware:	<b>1.4.6</b>
ModemConfigurator:	<b>1.4.2</b>
Date:	<b>2013-12-20</b>
Status:	<b>Confidential</b>
DocID:	<b>RT_UG_M1000_v.2.0.0</b>



***Robustel***

[www.robustel.com](http://www.robustel.com)

## About This Document

This document describes the hardware and software of the *Robustel M1000 series Industrial Smart Cellular Modem*.

**Copyright© Guangzhou Robustel Technologies Co., Limited  
All Rights Reserved.**

## Trademarks and Permissions

Robustel are trademark of Guangzhou Robustel Technologies Co. Limited.

All other trademarks and trade names mentioned in this document are the property of their respective holders.

## Disclaimer

No part of this document may be reproduced in any form without the written permission of the copyright owner. The contents of this document are subject to revision without notice due to continued progress in methodology, design and manufacturing. Robustel shall have no liability for any error or damage of any kind resulting from the use of this document.

## Technical Support Contact Information

Tel: +86-18924045664  
Fax: +86-20-82321505cellular  
E-mail: [support@robustel.com](mailto:support@robustel.com)  
Web: [www.robustel.com](http://www.robustel.com)

## Important Notice

Due to the nature of wireless communications, transmission and reception of data can never be guaranteed. Data may be delayed, corrupted (i.e., have errors) or be totally lost. Although significant delays or losses of data are rare when wireless devices such as the modem are used in a normal manner with a well-constructed network, the modem should not be used in situations where failure to transmit or receive data could result in damage of any kind to the user or any other party, including but not limited to personal injury, death, or loss of property. Robustel accepts no responsibility for damages of any kind resulting from delays or errors in data transmitted or received using the modem, or for failure of the modem to transmit or receive such data.

## Safety Precautions

### General

- The modem generates radio frequency (RF) power. When using the modem care must be taken on safety issues related to RF interference as well as regulations of RF equipment.
- Do not use your modem in aircraft, hospitals, petrol stations or in places where using CELLULAR products is prohibited.
- Be sure that the modem will not be interfering with nearby equipment. For example: pacemakers or medical equipment. The antenna of the modem should be away from computers, office equipment, home appliance, etc.
- An external antenna must be connected to the modem for proper operation. Only uses approved antenna with the modem. Please contact authorized distributor on finding an approved antenna.
- Always keep the antenna with minimum safety distance of 26.6 cm or more from human body. Do not put the antenna inside metallic box, containers, etc.

**Note:** *Some airlines may permit the use of cellular phones while the aircraft is on the ground and the door is open. Modem may be used at this time.*

### Using the modem in vehicle

- Check for any regulation or law authorizing the use of GSM in vehicle in your country before installing the modem.
- The driver or operator of any vehicle should not operate the modem while in control of a vehicle.
- Install the modem by qualified personnel. Consult your vehicle distributor for any possible interference of electronic parts by the modem.
- The modem should be connected to the vehicle's supply system by using a fuse-protected terminal in the vehicle's fuse box.
- Be careful when the modem is powered by the vehicle's main battery. The battery may be drained after extended period.



### Protecting your modem

- To ensure error-free usage, please install and operate your modem with care. Do remember the follow:
- Do not expose the modem to extreme conditions such as high humidity / rain, high temperatures, direct sunlight, caustic / harsh chemicals, dust, or water.
- Do not try to disassemble or modify the modem. There is no user serviceable part inside and the warranty would be void.

- Do not drop, hit or shake the modem. Do not use the modem under extreme vibrating conditions.
- Do not pull the antenna or power supply cable. Attach/detach by holding the connector.
- Connect the modem only according to the instruction manual. Failure to do it will void the warranty.
- In case of problem, please contact authorized distributor.

## Regulatory and Type Approval Information

**Table 1:** Directives

2002/95/EC	Directive of the European Parliament and of the Council of 27 January 2003 on the restriction of the use of certain hazardous substances in electrical and electronic equipment (RoHS)	
2002/96/EC	Directive of the European Parliament and of the Council on waste electrical and electronic equipment (WEEE)	
2003/108/EC	Directive of the European Parliament and of the Council of 8 December 2003 amending directive 2002/96/ec on waste electrical and electronic equipment (WEEE)	

**Table 2:** Standards of the Ministry of Information Industry of the People’s Republic of China

SJ/T 11363-2006	“Requirements for Concentration Limits for Certain Hazardous Substances in Electronic Information Products” (2006-06).	
SJ/T 11364-2006	<p>“Marking for Control of Pollution Caused by Electronic Information Products” (2006-06).</p> <p>According to the “Chinese Administration on the Control of Pollution caused by Electronic Information Products” (ACPEIP) the EPUP, i.e., Environmental Protection Use Period, of this product is 20 years as per the symbol shown here, unless otherwise marked. The EPUP is valid only as long as the product is operated within the operating limits described in the Hardware Interface Description.</p> <p>Please see <a href="#">Table 3</a> for an overview of toxic or hazardous substances or elements that might be contained in product parts in concentrations above the limits defined by SJ/T 11363-2006.</p>	

**Table 3:** Toxic or hazardous substances or elements with defined concentration limits

Name of the part	Hazardous substances					
	(Pb)	(Hg)	(Cd)	(Cr(VI))	(PBB)	(PBDE)
Metal Parts	o	o	o	o	o	o
Circuit Modules	x	o	o	o	o	o
Cables and Cable Assemblies	o	o	o	o	o	o
Plastic and Polymeric parts	o	o	o	o	o	o

**O:**  
Indicates that this toxic or hazardous substance contained in all of the homogeneous materials for this part is below the limit requirement in SJ/T11363-2006.

**X:**  
Indicates that this toxic or hazardous substance contained in at least one of the homogeneous materials for this part *might exceed* the limit requirement in SJ/T11363-2006.

**Revision History**

Updates between document versions are cumulative. Therefore, the latest document version contains all updates made to previous versions.

Release Date	Firmware Version	Doc Version	Details
2011-03-15	1.00	v.1.0.0	First Release
2013-12-20	1.46	v.2.0.0	Second Release

## Contents

Chapter 1.	Product Concept.....	8
1.1	Overview .....	8
1.2	Packing List.....	8
1.3	Specifications .....	10
1.4	Dimensions.....	12
1.5	Selection and Ordering Data .....	12
Chapter 2.	Installation.....	13
2.1	Overview .....	13
2.2	LED Indicators.....	13
2.3	Install SIM Card .....	14
2.4	Connect the External Antenna (SMA Type) .....	15
2.5	Connect the Modem to External Device .....	15
2.6	Connect I/O Device and Sensors .....	16
2.7	Mount the Modem .....	16
2.8	Ground the Modem .....	17
2.9	Power Supply .....	18
Chapter 3.	Operate the Modem .....	19
3.1	Working Mode Overview .....	19
3.2	Modem Configurator Overview .....	19
3.2.1	Starting Modem Configurator .....	20
3.2.2	Operation Area Introduction .....	21
3.2.3	Export and Import Profiles .....	23
3.2.4	Com.....	24
3.2.5	Basic.....	25
3.2.6	SMS Direct .....	26
3.2.7	Advanced .....	29
3.2.8	Modbus.....	30
3.2.9	Coil.....	32
3.2.10	Register .....	33
3.2.11	DI.....	35
3.2.12	DO.....	36
3.2.13	Reboot .....	39
3.2.14	Phone Book.....	40
3.2.15	Phone Group.....	41
3.2.16	Networks.....	42
3.2.17	Init. String .....	44
3.2.18	Debug (Only Available under “Normal Mode”).....	45
Chapter 4.	Typical Applications.....	48
4.1	AT Command Set (Only Available under Normal Mode).....	48
4.1.1	Starting Robustel Modem Configurator .....	48
4.1.2	Starting Windows Hyper Terminal.....	48
4.1.3	AT Commands Examples.....	50

4.2	GSM CSD Connection (Only Available under Normal Mode)	51
4.2.1	Overview	51
4.2.2	Establishing a CSD Connection	51
4.2.3	Answering a CSD Connection	53
4.3	Using Short Message Service by Using AT Commands (Only Available under Normal Mode)	54
4.3.1	Sending a Short Message	55
4.3.2	Reading a Short Message	55
4.3.3	Deleting a Short Message	56
4.4	Using SMS Direct (Only Available under Config Mode)	56
4.5	GPRS Connection (Only Available under Normal Mode)	57
4.5.1	Overview	57
Chapter 5.	Appendix	69
5.1	Factory Settings	69
5.2	Restore to Factory Default	69
5.3	SMS Commands for Remote Control	69
5.3.1	SMS Commands Structure	69
5.3.2	SMS Control Steps	70
5.3.3	SMS Commands List	70
5.3.4	SMS Control Examples	76
5.4	Modbus Address Mapping	77
5.5	GSM Alphabet	77
5.6	Troubleshooting	81
5.5.1	The modem’s LED does not light:	81
5.5.2	M1000 keep rebooting all the time:	81
5.5.3	No connection with modem through serial link	81
5.5.4	Receiving “No Carrier” Message	82
5.7	Terms and Abbreviations	82



# Chapter 1. Product Concept

## 1.1 Overview

Robustel GoRugged M1000 is a rugged smart cellular modem offering state-of-the-art GSM/GPRS/EDGE connectivity for machine to machine (M2M) applications.

- Control via AT commands (Hayes 3GPP TS 27.007 and 27.005).
- GPRS, TCP/IP, SMS, CSD access via AT commands.
- Featured SMS Direct mode which can transparently convert serial data to SMS or vice versa without using AT Commands. Verification of incoming Caller ID is implemented to block un-authorized users.
- Supports Modbus RTU slave protocol, converts alarm to SMS without using AT commands.
- Auto reboot via SMS/Caller ID/Timing.
- Remote configuration via SMS.
- RS232/RS485 selectable by software, 1DI/1DO.
- Six LED indicators provide signal strength (RSSI) and status.
- Wide range input voltages from 9 to 36 VDC and extreme operating temperature.
- The metal enclosure can be mounted on a DIN-rail or on the wall, also with extra ground screw.
- Firmware upgrade via serial interface.

## 1.2 Packing List

Check your package to make certain it contains the following items:

- Robustel GoRugged M1000 modem x1

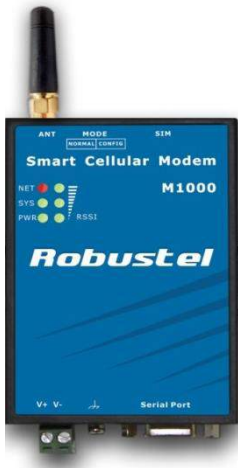

- 2-pin pluggable terminal block for power connector x1



- CD with user guide and configuration utility x1

**Note:** Please notify your sales representative if any of the above items are missing or damaged.

Optional accessories (can be purchased separately):

- SMA antenna (Stubby antenna or Magnet antenna optional) x1

**Stubby antenna**

**Magnet antenna**



- Serial cable for RS232 (DB9 Female to DB9 Male, 1 meter) x1



- Wall Mounting Kit



- 35mm Din-Rail mounting kit



- AC/DC Power Supply Adapter (12VDC, 1A) x1



- DB9 Male to 9-pin 5mm pluggable terminal block for serial port and DI/DO x1

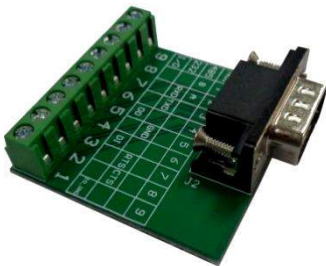

## 1.3 Specifications

### Cellular Interface

- Standards: GSM/GPRS/EDGE
- GPRS: max. 86 kbps (DL & UL), class 10
- EDGE: max. 236.8 kbps (DL & UL), class 12
- Frequency: 850/900/1800/1900 MHz for GPRS/EDGE
- CSD: Up to 14.4 kbps
- SIM: 1 x (3V & 1.8V)
- Antenna Interface: SMA Female

### Serial Interface

- Number of Ports: 1 x DB9 Female
- Serial Standards: RS232 and RS485
- ESD Protection:  $\pm 15\text{KV}$
- Baudrate: 8N1, 1200bps to 115200bps
- RS-232: TxD, RxD, RTS, CTS, GND
- RS-485: Data+ (A), Data- (B), GND

### Digital Input

- Type: Dry Contact, DI or event counter
- Dry Contact: On: open, Off: short to GND
- Isolation: 3K VDC or 2K Vrms
- Counter Frequency: 900 Hz
- Digital Filtering Time Interval: Software selectable

### Digital Output

- Type: Sink, DO or pulse output
- Pulse Output Frequency: 1 kHz
- Isolation: 3K VDC or 2K Vrms

### System

- LED Indicators: PWR, RUN, NET and 3 level RSSI
- Real Time Clock: Built-in RTC with button battery
- Watchdog and Timer: Built-in watchdog and timer

### Power Supply and Consumption

- Power Supply Interface: 2-pin 5mm pluggable terminal block
- Input Voltage: 9 to 36 VDC
- Power Consumption: Idle: 50-60 mA @ 12 V  
Data Link: 100 to 200 mA (peak) @ 12 V

### Physical Characteristics

- Housing & Weight: Metal, 300g
- Dimension(L x W x H): 102 x 71 x 29 mm
- Installation: 35mm Din-Rail or wall mounting or desktop

## 1.4 Dimensions

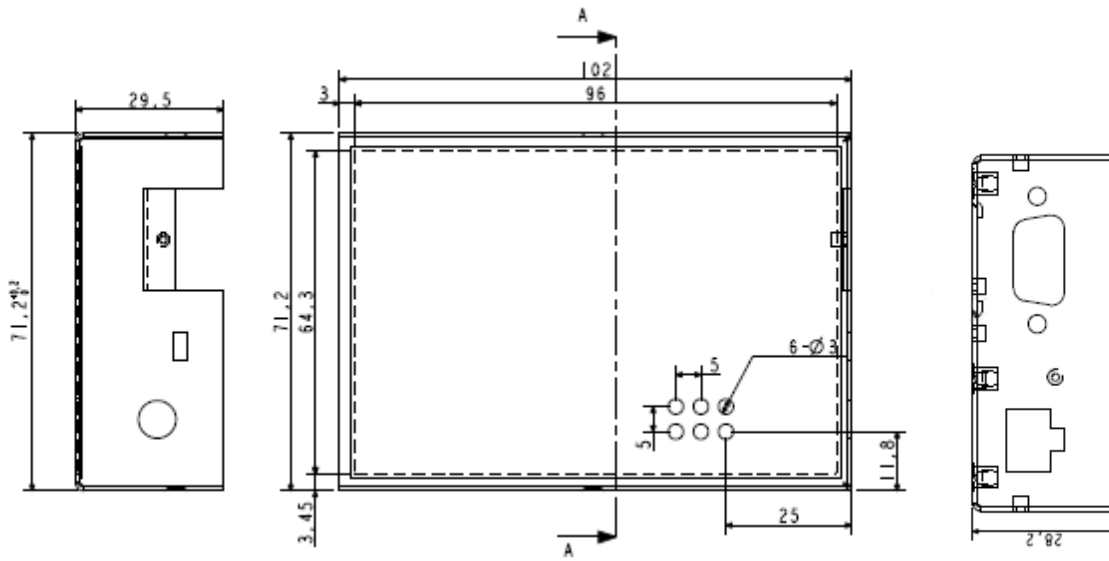

## 1.5 Selection and Ordering Data

Please refer to corresponding M1000 series datasheet.

# Chapter 2. Installation

## 2.1 Overview

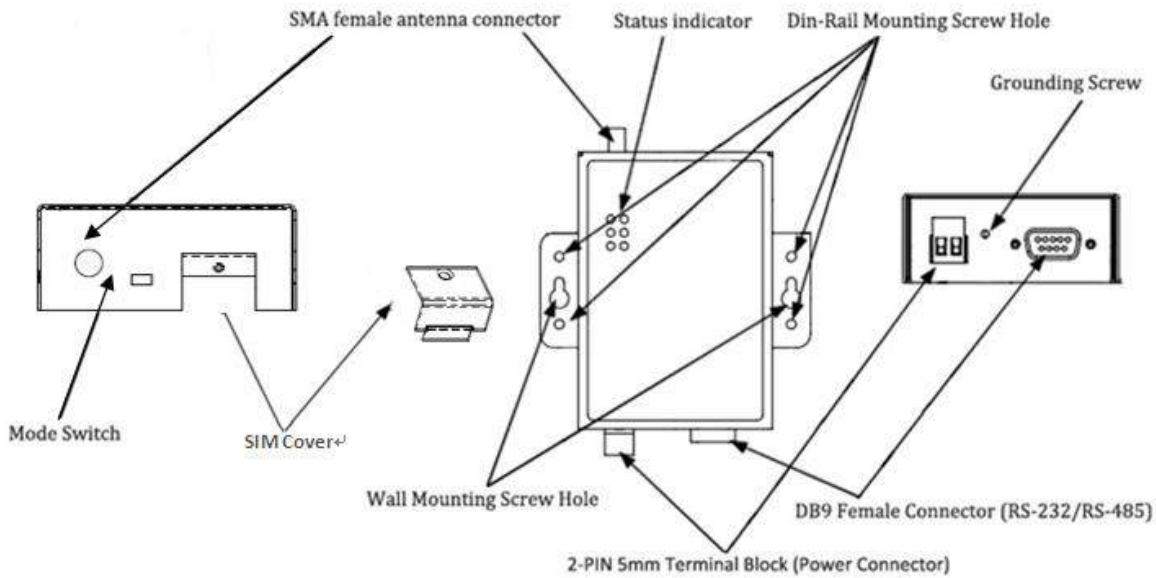

## 2.2 LED Indicators

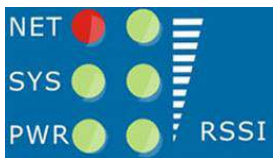

Name	Color	Function
RSSI (3 LEDs)	Green	Cellular signal strength level
NET	Red	Please refer to <b>Table ME Functions</b>
SYS	Green	Indicating the working mode. Normal: blinking 1 time/2 seconds Config: blinking 2 times/second
PWR	Green	On when DC power connection

RSSI LEDs	Function
None	No signal or SIM card not installed properly
1 bar	Weak or insufficient signal (SMS only)
2 bars	Average signal (GSM/CSD and GPRS connections)
3 bars	Exceptional signal (GSM/CSD and GPRS connections)

## ME Functions

NET LED	Function
Off	ME is in one of the following modes: - POWER DOWN mode - ALARM mode - CHARGE ONLY mode - NON-CYCLIC SLEEP mode - CYCLIC SLEEP mode with no temporary wake-up event in progress
600 ms on / 600ms off	Limited Network Service: No SIM card inserted or no PIN entered, or network search in progress, or ongoing user authentication, or network login in progress.
75 ms on / 3 s off	IDLE mode: The mobile is registered to the GSM network (monitoring control channels and user interactions). No call is in progress.
75 ms on / 75 ms off / 75 ms on / 3 s off	One or more GPRS PDP contexts activated.
500 ms on / 25 ms off	Packet switched data transfer is in progress.
On	Depending on type of call: Voice call: Connected to remote party. Data call: Connected to remote party or exchange of parameters while setting up or disconnecting a call.

## 2.3 Install SIM Card

Be sure to insert a SIM card before you use the modem.

**Note:** A SIM card set with PIN code cannot be used normally in the modem. You need to use Modem Configurator to unlock the PIN code of the SIM card before using it in the modem.

Make sure to disconnect the adapter and switch off your modem before inserting or removing your SIM/USIM card.

### ■ Inserting SIM Card

1. Make sure your adapter is disconnected.
2. Use a screwdriver to unscrew the screw on the cover, and then remove the cover, you could find the SIM Card slot.
3. Insert the SIM card, and you need press the SIM card with your fingers until you hear “a cracking sound”. Then use a screwdriver to screw the cover.

### ■ Removing SIM card

1. Make sure your adapter is disconnected, and then press and hold down the power key until the modem is powered off.
2. Press the SIM card until you hear “a cracking sound”, when the SIM card will pop up to be pulled out.

**Note:**

1. Don't forget screw the cover for again-theft.
2. Don't touch the metal surface of the SIM card in case information in the card is lost or destroyed.
3. Don't bend or scratch your SIM card. Keep the card away from electricity and magnetism.

4. Make sure to disconnect the power source from your modem before inserting and removing your SIM card.



## 2.4 Connect the External Antenna (SMA Type)

Connect this to an external antenna with SMA male connector. Make sure the antenna is for the correct frequency as your GSM operator with impedance of 50ohm, and also connector is secured tightly.

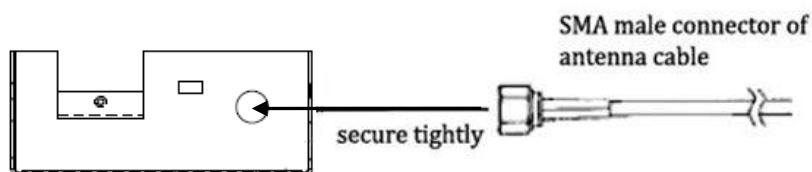

## 2.5 Connect the Modem to External Device

User can use the serial cable to connect the modem's DB9 female connector to external controller / computer.

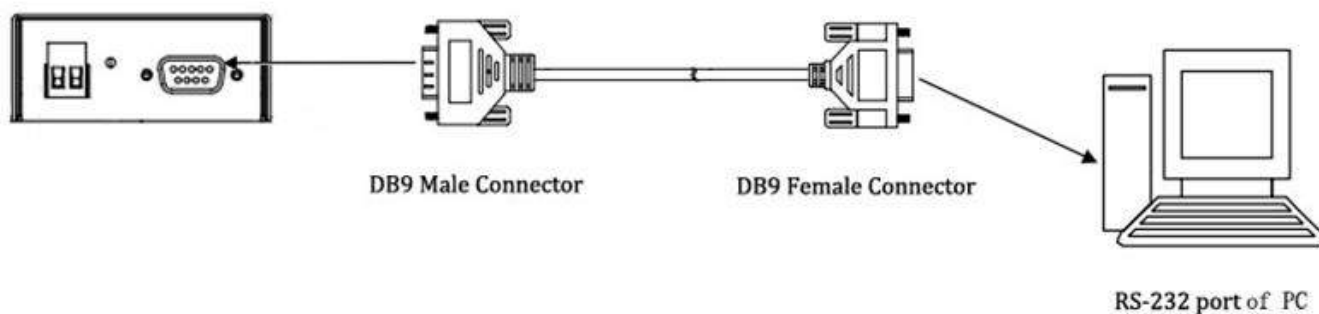

**PIN assignment for modem's DB9 female connector**



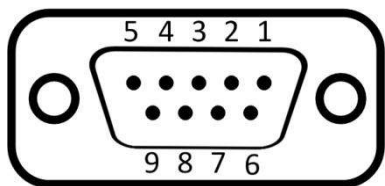

PIN	RS232	RS485 (2-wire)	I/O
1		Data- (B)	
2	RXD ->	Data+ (A)	
3	TXD <-		
4			DO
5	GND	GND	
6			DI
7	RTS <-		
8	CTS ->		
9			IO GND

## 2.6 Connect I/O Device and Sensors

Digital Input Dry Contact:

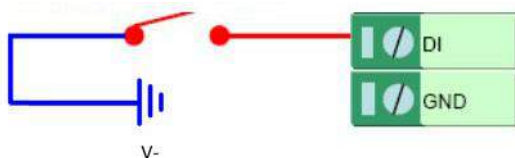

Digital Output (Sink Type)

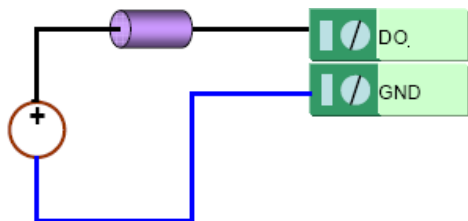

## 2.7 Mount the Modem

Use 2 pcs of M3 screw to mount the modem on the wall.

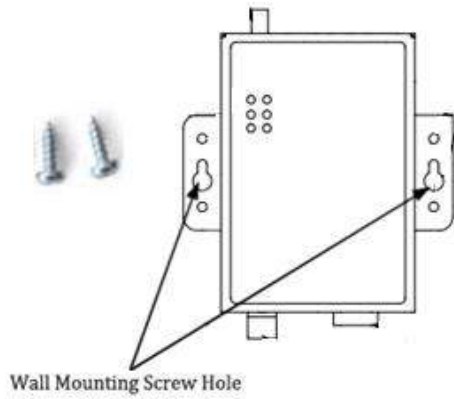

Or to mount the modem on a DIN rail, you need three pcs of M3 screws.



## 2.8 Ground the Modem

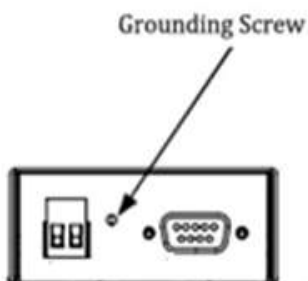

Grounding and wire routing help limit the effects of noise due to electromagnetic interference (EMI). Run the ground connection from the ground screw to the grounding surface prior to connecting devices.

**Note:** *This product is intended to be mounted to a well-grounded mounting surface, such as a metal panel.*

## 2.9 Power Supply

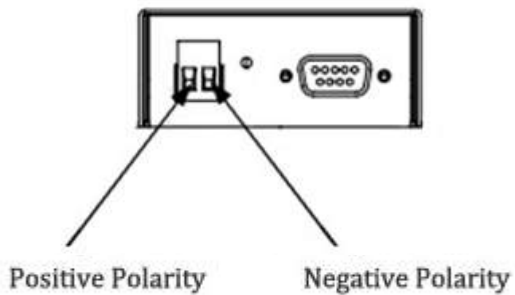

The power supply range is 9 to 36VDC.

**Note:** Please take care about the polarity, and do not make reverse connection.

## Chapter 3. Operate the Modem

### 3.1 Working Mode Overview

There are two working modes available in the modem, please read carefully before operate the Modem Configurator software:

Mode	Description
<b>Config Mode</b>	<p>When DIP switches to <b>Config Mode</b>, user could use follow functions:</p> <ol style="list-style-type: none"> <li>1. Configure modem via <b>Modem Configurator</b>;</li> <li>2. SMS Direct;</li> <li>3. Auto-reboot;</li> <li>4. Upgrade firmware.</li> </ol> <p><b>Serial port default parameters: 115200, 8, None, 1</b></p>
<b>Normal Mode</b>	<p>When DIP switches to <b>Normal Mode</b>, user could use follow functions:</p> <ol style="list-style-type: none"> <li>1. Control modem via AT commands;</li> <li>2. Send/receive SMS via AT commands;</li> <li>3. CSD communications;</li> <li>4. GPRS communications;</li> <li>5. Auto-reboot.</li> </ol> <p><b>Serial port default parameters: Autobauding</b>  <b>The autobauding mode allows the modem to automatically detect the transmission speed used by the DTE.</b>  <b>Only the following speeds will be detected: 300, 600, 1200, 2400, 4800, 9600, 14400, 19200, 28800, 38400, 57600, 115200bps. Autobauding detection cannot be guaranteed for speeds below or above these speeds.</b></p>

### 3.2 Modem Configurator Overview

Modem Configurator is a PC-based configuration software tool for managing and configuring Robustel M1000 series modems. With a full graphics mode and Windows-based environment, even first time users will find it easy to learn how to use this new software tool. Modem Configurator can be used to configure the general phone settings and modes, but without needing to look up the appropriate AT commands. Modem Configurator provides a big improvement over the traditional configuration method that often required frequent checking of a thick AT command reference manual.

Modem Configurator not only makes configuration easier, but also makes it convenient to carry out “mass deployment” and “pre-configuration,” but without the need to use AT commands. The most important benefits of

using the “Modem Configurator” utility are:

1. Green software, no need installation;
2. Full graphics mode, easy to learn how to configure the M1000 series modems;
3. The configuration profile can be easily stored, and then replicated to other modems;
4. Easy to upgrade modem firmware.

**Note:** Modem Configurator can be used with Windows 2000/XP/Vista/7 32/64-bit operation systems.

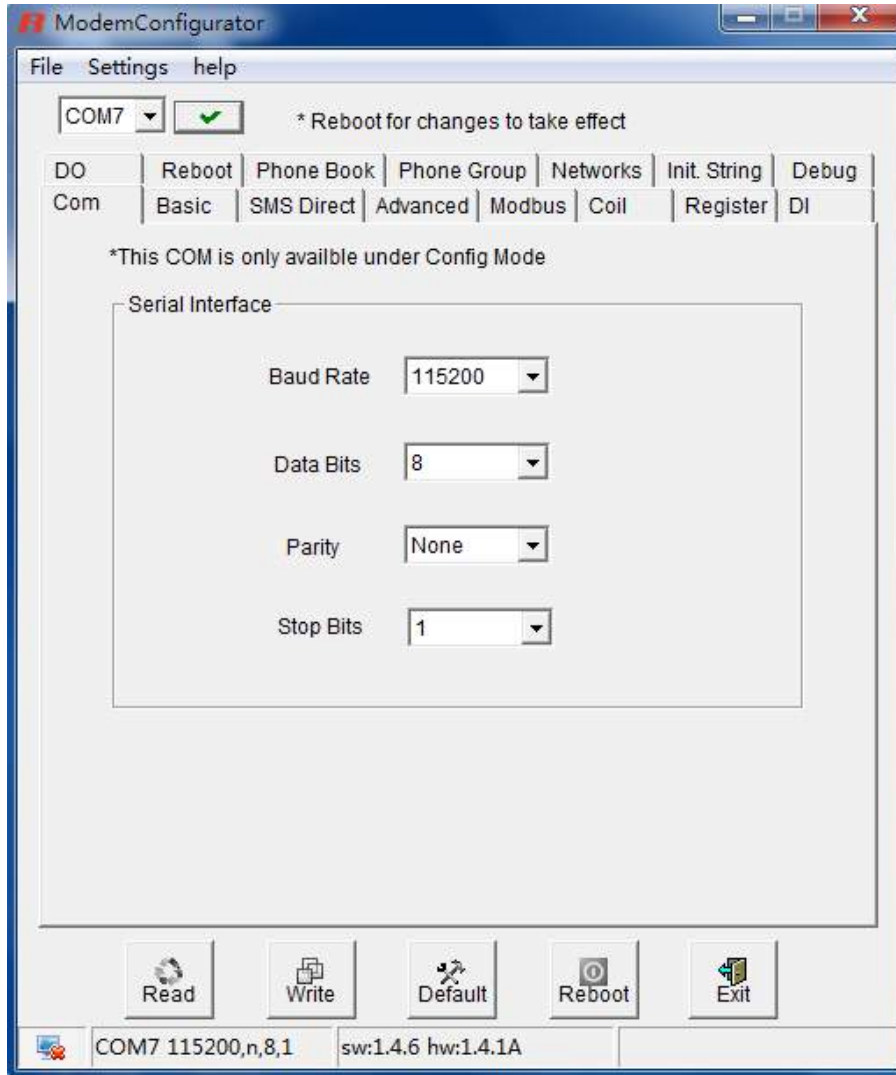

### 3.2.1 Starting Modem Configurator

1. Switch the modem to “Config Mode”, connect the RS-232 port of the modem to a host PC, then power on the modem.
2. Double click “Modem Configurator.exe” to start the software.





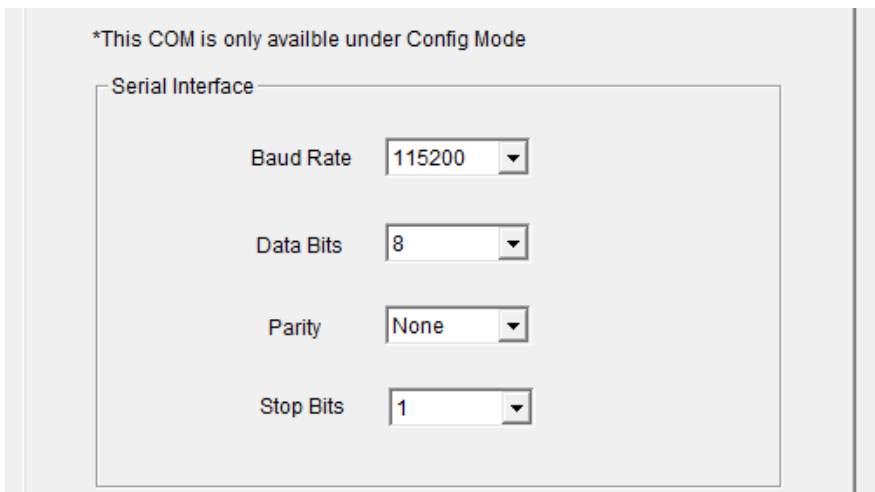



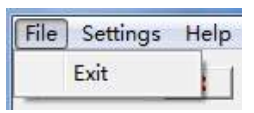
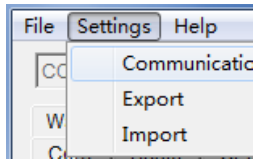

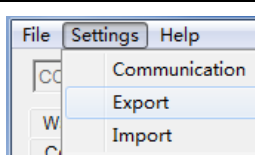
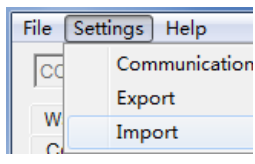

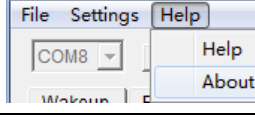
3. Select the correct serial port which is connecting to the modem, then click  button. After that you can see the popup windows "Operation Succeed".

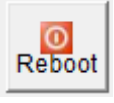
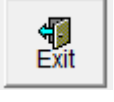

### 3.2.2 Operation Area Introduction

Menu	Icon	Description
File->Exit		Exit the Modem Configurator.
Settings->Communication		Set the communication ways of configurator: Serial or TCP.

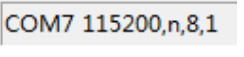
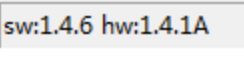
Settings->Export		Export the Modem's current configuration file to your local PC.
Settings->Import		Import the Modem's configuration file from local PC to the Modem.
Help->Help		Show some notices about this configurator.
Help->About		Manufacturer's information and Modem Configurator version.
Port No.		Select the local RS-232 port to communicate with the Modem.
Connect		Connect the Modem Configurator to the Modem.
Disconnect		Disconnect the Modem Configurator to the Modem, and release the PC's RS-232 port.
Read		Read Modem's current settings.
Write		Save changes into Modem. <b>Note:</b> Reboot for changes to take effect.
Default		Set Modem to default factory settings.
Reboot		Reboot the Modem.
Exit		Exit the Modem Configurator.
Disconnecting		Modem is not communicating with Modem Configurator.
Connecting		Modem is communicating with Modem Configurator.
Serial Management Settings		Show current RS232 communication parameter.
Version		Show current software and hardware version of Modem.

**Important Notice**

1. You must save your parameter changes by clicking “Write” button and then reboot your M1000 by clicking “Reboot” button to take effect for the parameter changes.
2. **Debug** tab is only available under **Normal Mode**, other tabs are available under **Config Mode**.

**3.2.3 Export and Import Profiles**

Users could export modem settings from one modem, and then import the same settings to other modems, which makes it convenient to carry out “mass deployment” and “pre-configuration”.

1. Select **Export** from the **Settings** menu. Then select a folder and enter the file name for the profile. Click on **Save**, then it will popup “Export Succeed” windows.

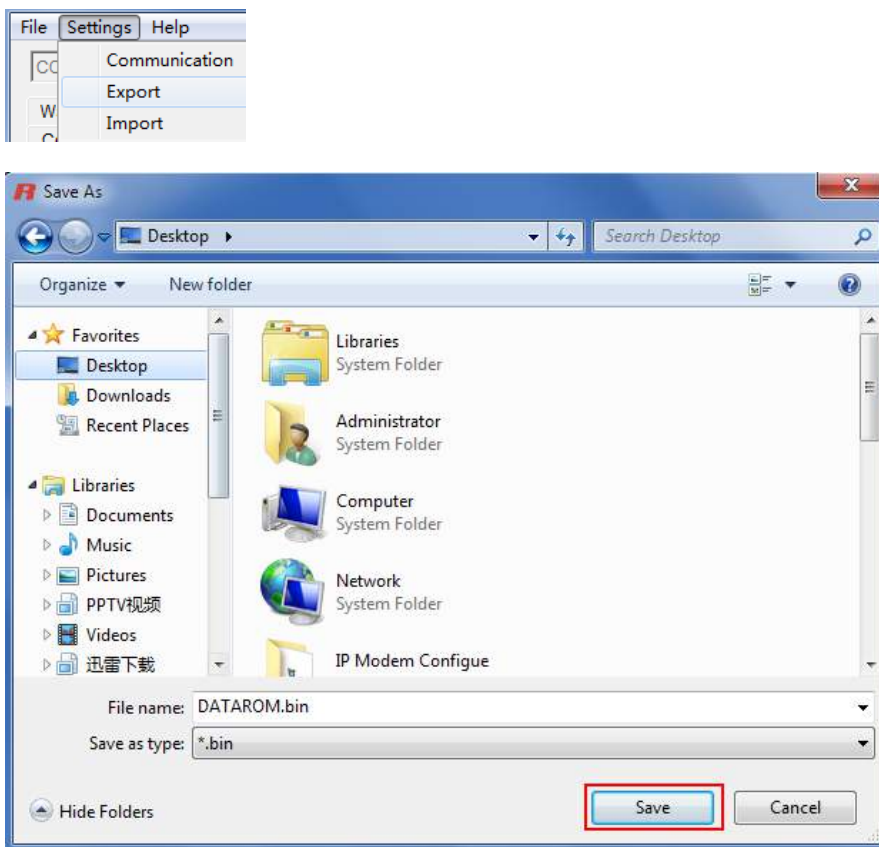

2. Select **Import** from the **Settings** menu. Then select a profile. Click on **Open**.





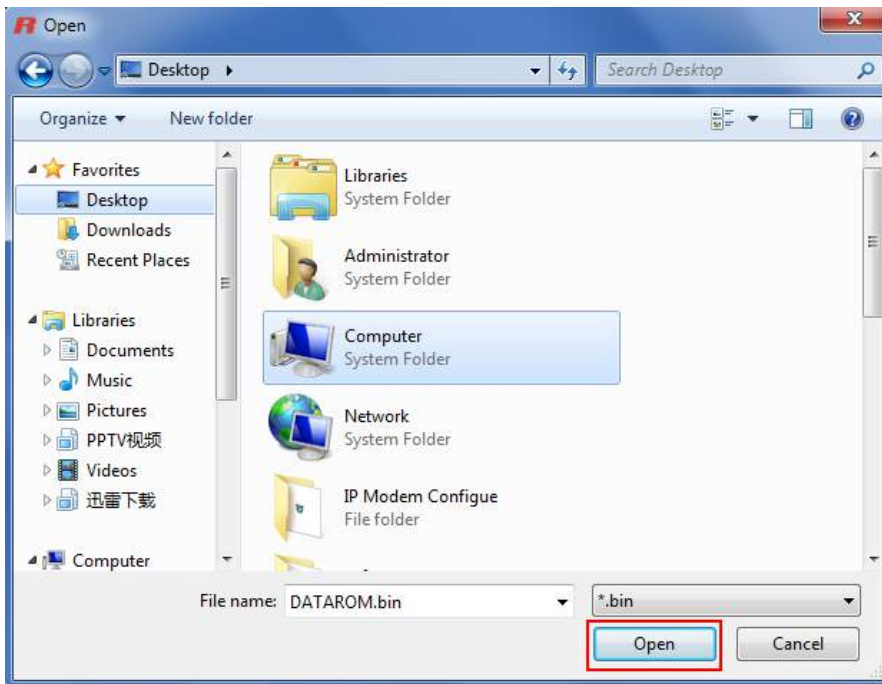

3. Click “Write” button then it will popup “Import Succeed” windows.

### 3.2.4 Com

This tab allows user to set Com tab when modem is set into Config Mode.

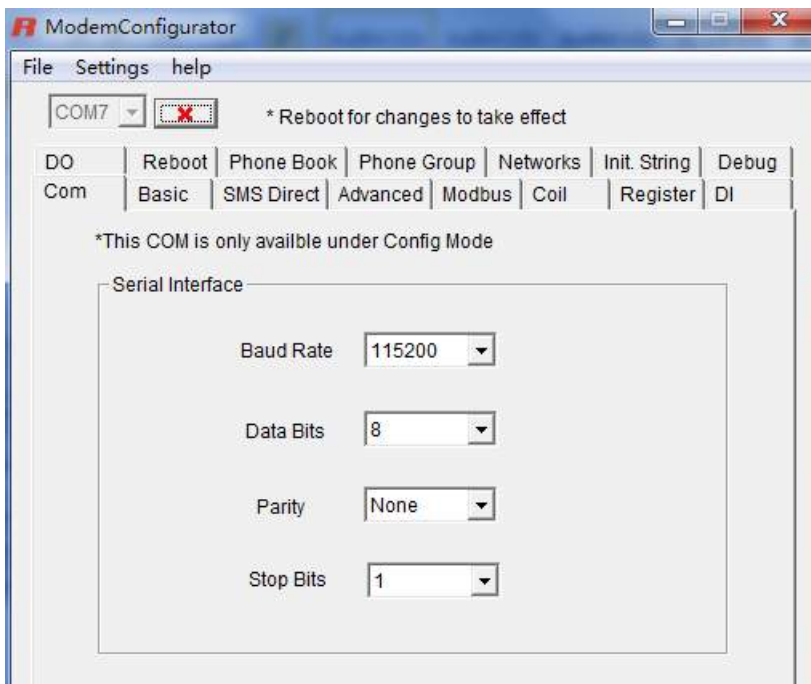

COM		
Item	Description	Default
Baud Rate	Select from "1200", "2400", "4800", "9600", "19200", "38400", "57600" and "115200".	115200
Data Bits	Select from "7" and "8".	8
Parity	Select from "None", "Odd", "Even", "Mark" and "Space".	None
Stop Bits	Select from "1" and "2".	1

### 3.2.5 Basic

This tab allows user to set follow items:

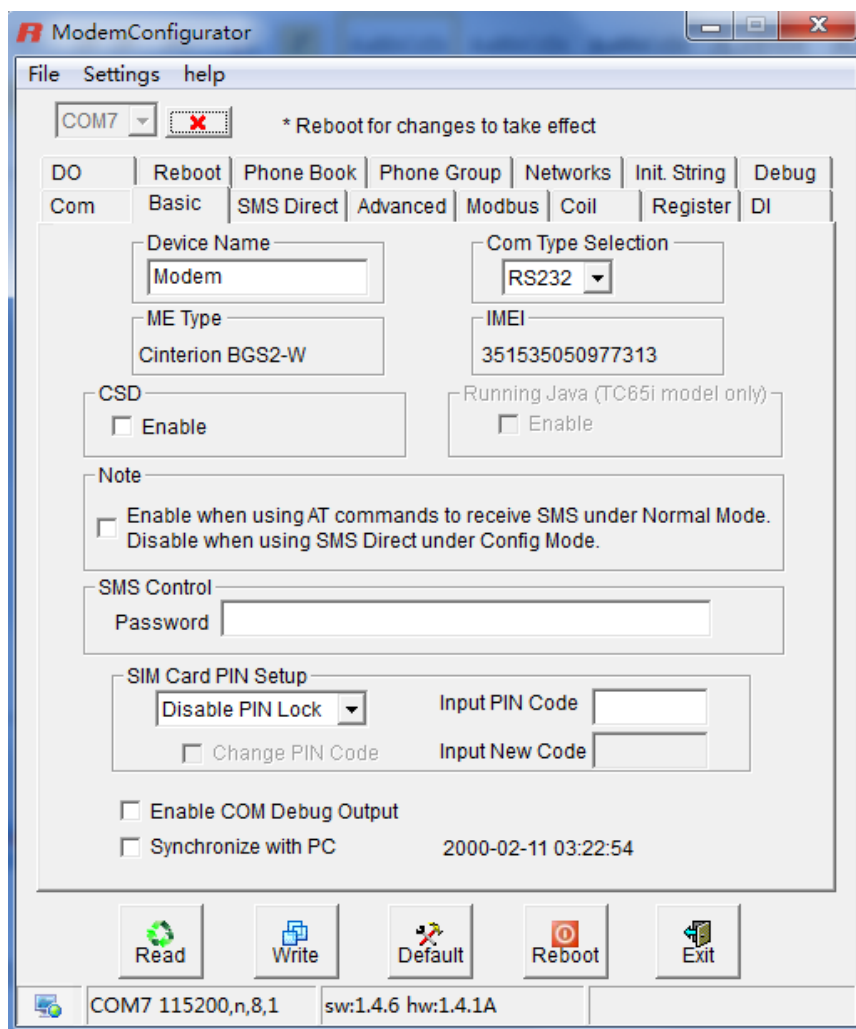

Basic		
Item	Description	Default
Device Name	Write down the description name of the modem, such as write down the modem installation site name in order to identify each modem.	Modem
Com Type Selection	Select from "RS232" and "RS485". <b>Note:</b> Please refer to your part number and check whether your model	RS232

	<i>supports RS485 or not.</i>	
ME Type	Cellular module information, vary to each part number.	E.g. Cinterion MC55i, which is Cinterion MC55i GSM / GPRS module
IMEI	Cellular module's IMEI number.	Vary to different cellular module
CSD	Click to enable <b>CSD</b> function under <b>Normal Mode</b> .	Disable
Running JAVA	When running JAVA virtual machine under <b>Normal Mode</b> , please enable this option. This optional is only available for M1000-JC651A and M1000-JC651B. <b>Note:</b> <i>after enable this option TC65i module will only run JAVA software, other features such as SMS Direct, Reboot configured in Config Mode will be disabled; user could develop such features by JAVA if needed.</i>	Disable
Note	When using AT commands to receive SMS under <b>Normal Mode</b> , please enable the option. When using SMS Direct under <b>Config Mode</b> , please disable the option.	Disable
SMS Control Password	Password for SMS remote configuration.	Null
SIM Card PIN Setup	Select from "Disable PIN Lock" and "Enable PIN Lock". After enable PIN lock, user could input your SIM's PIN and store the current PIN in its memory, and then enter the PIN automatically each time the system boots up. <b>Note:</b> <i>Please ask your local GSM ISP to see whether your SIM card requiring PIN or not.</i> If user wants to change the SIM PIN, please tick the "Change PIN Code" checkbox to enable it, and then input the new PIN at "Input New Code".	Disable
Enable COM Debug Output	Click to output debug information via serial port.	Disable
Synchronize with PC	Synchronize modem's RTC to PC's clock. The modem's current RTC will be showed at left side of this function.	Modem factory RTC

### 3.2.6 SMS Direct

A major benefit of GSM technology is that it supports short messages (SMS) for easy communication over the mobile network. Robustel's proprietary SMS Direct allows you to expand your applications and reduce cost. For example, SMS Direct can be used to update the message on a highway display panel, place refill orders for vending machines, handle maintenance for remote rental equipment, or even help create an SMS alarm by directly transforming text, binary, or unicode data from a legacy device to short messages, but without using AT Commands. SMS Direct is particularly suitable for devices that communicate infrequently, or lack access to the local network. SMS Direct

converts ASCII and binary data to short message transparently (both back and forth). In addition, a caller ID (phone number) identification can be used to block the message sent from the uncertified users, broadcast messages, and unwanted SMS advertisements.

Robustel’s proprietary SMS Direct has the following features:

1. Transparently converts serial data to short message or vice versa **without using AT Commands**.
2. Text, binary, and Unicode formats are supported.
3. Verification of Incoming Caller ID is implemented to block uncertified users.
4. The configuration profile can be easily stored, and then copied to other modems.



The follow table introduces the SMS Direct function.

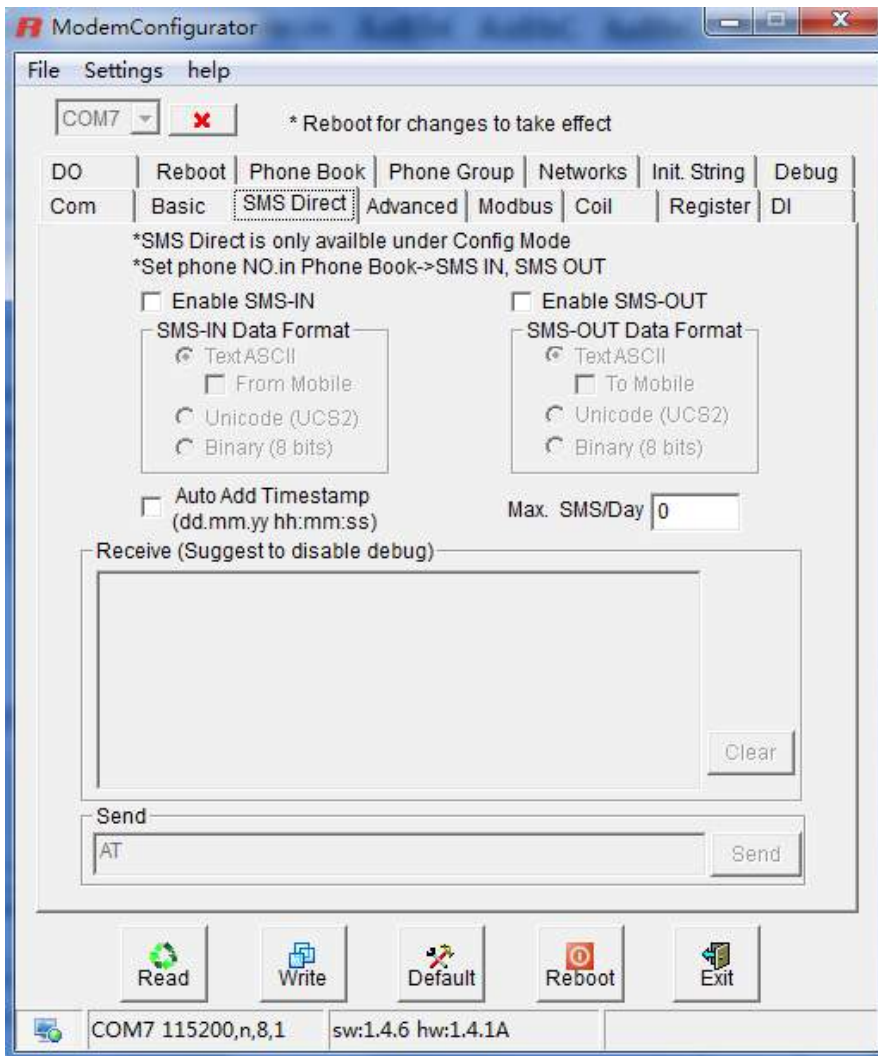

## SMS Direct

**Note: This function is only available under "Config Mode".**

Item	Description	Default
Enable SMS-IN	Tick the <b>SMS-IN</b> checkbox to allow forwarding of incoming short messages from specified <b>Caller ID</b> to the modem's serial port as data. The <b>Caller ID</b> (phone number) should be specified in " <b>Phone Book</b> " tab by inputting the phone number and tick " <b>SMS In</b> " checkbox.	Disable
Enable SMS-OUT	Tick the <b>SMS-OUT</b> checkbox to allow data received from the attached serial device to be transmitted as short messages to <b>Target Phone Number</b> . The <b>Target Phone Number</b> (phone number) should be specified in " <b>Phone Book</b> " tab by inputting the phone number and tick " <b>SMS Out</b> " checkbox.	Disable
Text ASCII	7 bits text format (160 bytes per packet)	Disable
From Mobile	Enable when receiving text (ASCII) SMS from mobile phone. Disable when receiving text (ASCII) SMS from mobile phone.	Disable
To Mobile	Enable when sending text (ASCII) SMS from mobile phone. Disable when sending text (ASCII) SMS from mobile phone.	Disable
Unicode (UCS2)	16 bits Unicode (UCS2) format (70 bytes per packet)	Disable
Binary (8 bits)	8 bits binary (140 bytes per packet)	Disable
Auto Add Timestamp	Auto adds timestamp at the beginning of the SMS. Timestamp format is <b>dd.mm.yy hh:mm:ss</b>	Disable
Max. SMS/Day	Set daily limitation for sending SMS in SMS Direct function, when reaching the maximum limitation, M1000 will stop sending SMS any more at that day. 0 is no limitation. Customer could also clear the counter by sending SMS to M1000 with SMS Control privilege, the SMS is " <b>clear sms counter</b> "	0
Receive	After enable <b>SMS-IN</b> function, <b>Receive</b> windows will be available, the incoming short messages from specified <b>Caller ID</b> to the modem's serial port will be displayed in this item.	Disable
Send	After enable <b>SMS-Out</b> function, <b>Send</b> windows will be available, user could input any text message in this item which will be transmitted as short messages to <b>Target Phone Number</b> .	Disable

**Note:**

1. The phone numbers for SMS Direct function can be set in Phone Book tab.
2. The **Target Phone Number** must be specified if **SMS-OUT** is activated.
3. The **Target Phone Number** and **Caller ID** must be written in international format, starting with "+" followed by the country code.
4. If you leave **Caller ID** blank, the modem will allow all incoming short messages as serial data to be forwarded to its serial port. This includes system broadcasts and advertisements.
5. The timeout between characters is 0.5 second. Messages that require a longer time period will be split into 2 or more messages.

## SMS Data Format

Text ASCII	7 bits text format (160 bytes per packet)
Unicode	16 bits Unicode (UCS2) format (70 bytes per

	packet)
Binary	8 bits binary (140 bytes per packet)

**Note:** ☒ is not supported in ASCII.

### 3.2.7 Advanced

Advanced settings for SMS Direct.

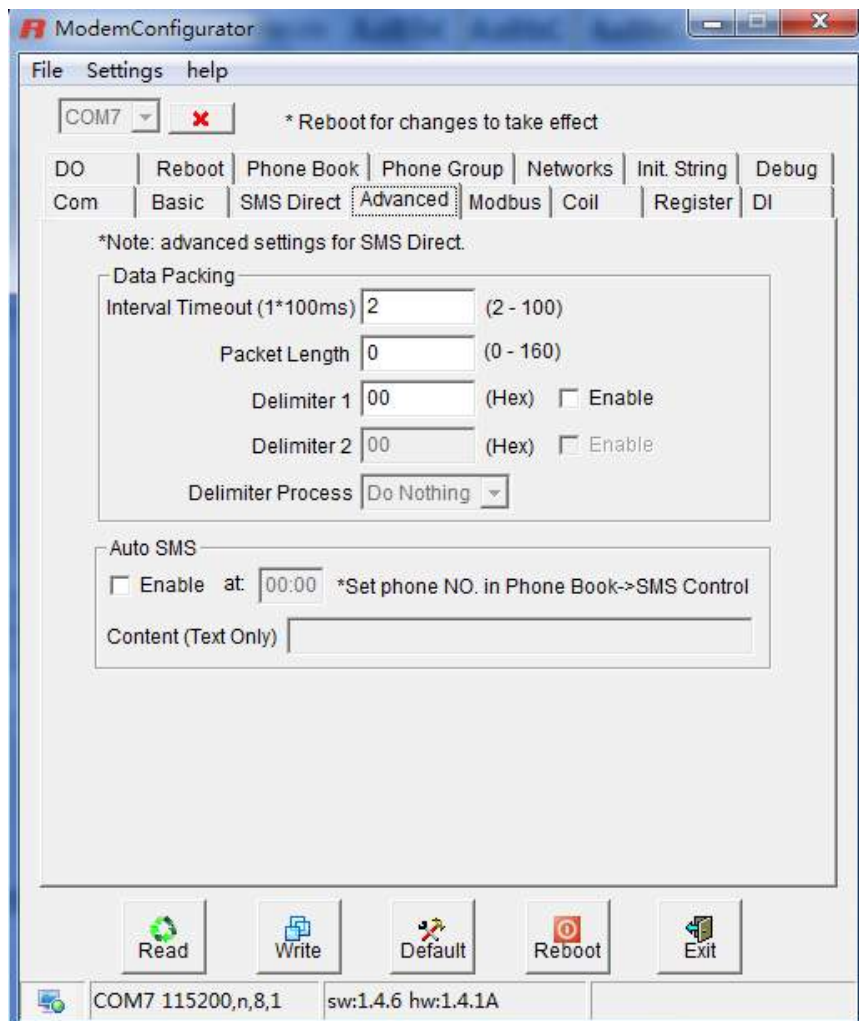

Advanced		
Item	Description	Default
Interval Timeout	<p><b>Interval Timeout</b> is the maximum timeout between two packets from serial port. M1000 will process as 2 SMS if the interval between two packets is larger than the value set in the box.</p> <p>The units of the timeout is 100ms, default value is 2, which mean the default packet timeout is 200ms.</p> <p><b>Note:</b> SMS will also be sent as specified by the packet length or delimiter settings even</p>	2

	<i>when SMS is not reaching the preset interval timeout.</i>	
Packet Length	<p>The Packet length setting refers to the maximum amount of data that is allowed to accumulate in the serial port buffer before sending. At the default of 0 for packet length, no maximum amount is specified and data in the buffer will be sent as specified by the interval timeout or delimiter settings. When a packet length between 1 and 140/160 bytes is specified, data in the buffer will be sent as soon it reaches the specified length. 0 is no limitation.</p> <p>SMS use Text ASCII has a maximum length of 160 bytes. SMS use Unicode (UCS2) and Binary (8 bits) has a maximum length of 140 bytes.</p> <p><b>Note:</b> SMS will also be sent as specified by the interval timeout or delimiter settings even when SMS is not reaching the preset packet length.</p>	0
Delimiter 1 and Delimiter 2	<p>When Delimiter 1 is enabled, the serial port will queue the data in the buffer and send the data to the Cellular port when a specific character, entered in hex format, is received. A second delimiter character may be enabled and specified in the Delimiter 2 field, so that both characters act as the delimiter to control when data should be sent.</p>	Disable
Delimiter Process	<p><b>Delimiter process</b> (default=Do Nothing): The Delimiter process field determines how the data is handled when a delimiter is received. Delimiter 1 must be enabled for this field to have effect. If Delimiters 1 and 2 are both enabled, both characters must be received for the delimiter process to take place.</p> <p><b>Do Nothing:</b> Data in the buffer will be transmitted when the delimiter is received.</p> <p><b>Strip Delimiter:</b> Data in the buffer is first stripped of the delimiter before being transmitted.</p> <p><b>Note:</b> SMS will also be sent as specified by the interval timeout or packet length settings even when there is no preset Delimiters.</p>	Do Nothing
Auto SMS	<p>Click to enable <b>Auto SMS</b> function, which will send SMS to preset phone numbers in <b>Phonebook-&gt;SMS Control</b>.</p> <p>SMS sending time and content is configurable.</p> <p><b>Note:</b> Only support text format SMS.</p>	Disable
Content(Text Only)	Enter the SMS content here.	Null

### 3.2.8 Modbus

This tab describes Digital Output settings.

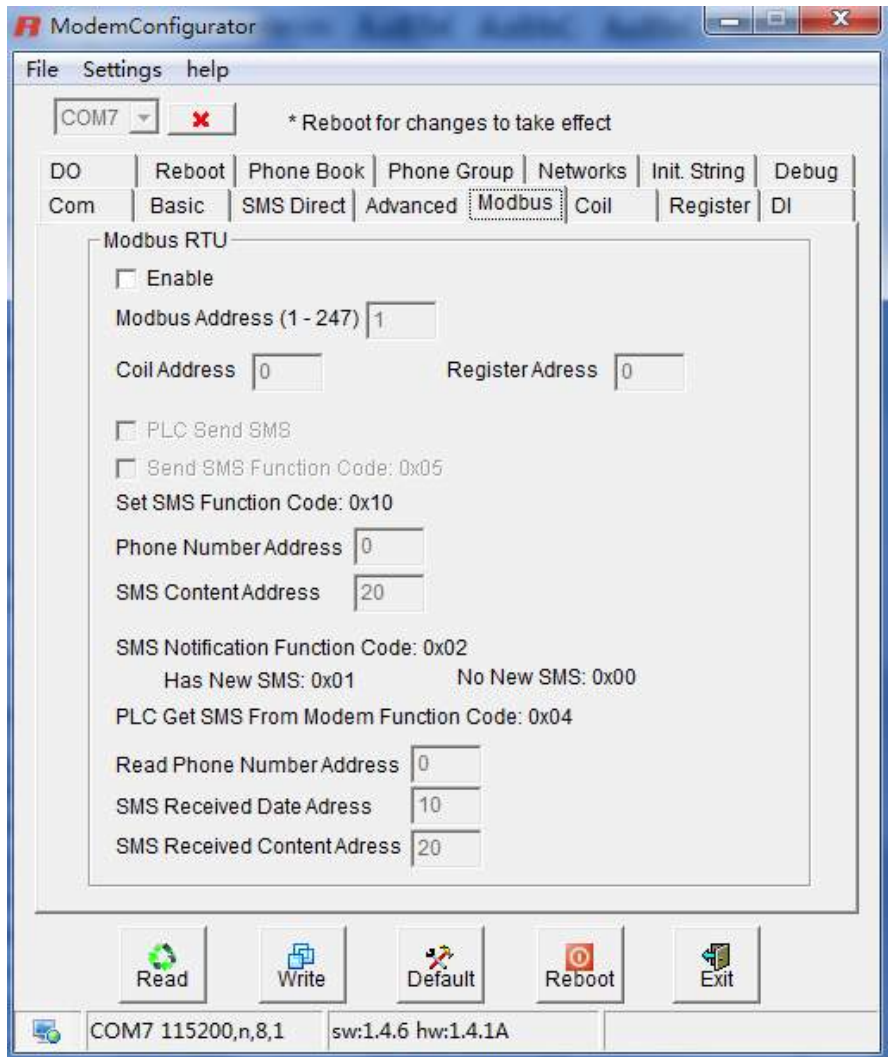

Modbus		
Item	Description	Default
Enable	Tick to enable Modbus RTU Slave function in the modem.	Disable
Slave ID	Modbus slave ID, input from 1 to 247.	1
Coil Address	Modbus address to read coils (0x01) or write single coil (0x05). Input from 0 to 65535.	0
Register Address	Modbus address to read holding register (0x03) or write single register (0x05). Input from 0 to 65535	0
PLC Send SMS	Tick to enable. The PLC will poll the modem to send SMS, in which the SMS content and phone number can be set by PLC.	Disable
Send SMS Function Code (0x05)	Read only parameters. The function code for sending SMS.	/
Set SMS Function Code (0x10)	Read only parameters. The function code for setting SMS content and phone number.	/



Phone Number Address	The start address to save phone number, total 16 registers.	0
SMS Content Address	The start address to save SMS content, total 35 registers.	20
SMS Notification Function Code (0x02)	Read only parameters. The function code for the PLC polling the modem to check whether there is new SMS.	/
Have New SMS (0x01)	Read only parameters. During polling, when there is new SMS, modem will reply 0x01.	/
No New SMS (0x00)	Read only parameters. During polling, when there is no new SMS, modem will reply 0x00.	/
PLC Get SMS From Modem Function Code (0x04):	Read only parameters. The function code for the PLC to read new SMS and get its content.	/
Read Phone Number Address	The start address to save received SMS phone number, total 10 registers.	0
SMS Received Date Address	The start address to save received SMS date, total 6 registers.	0
SMS received Content Address	The start address to save received SMS content, total 70 registers.	0

### 3.2.9 Coil

This tab describes Coil settings.

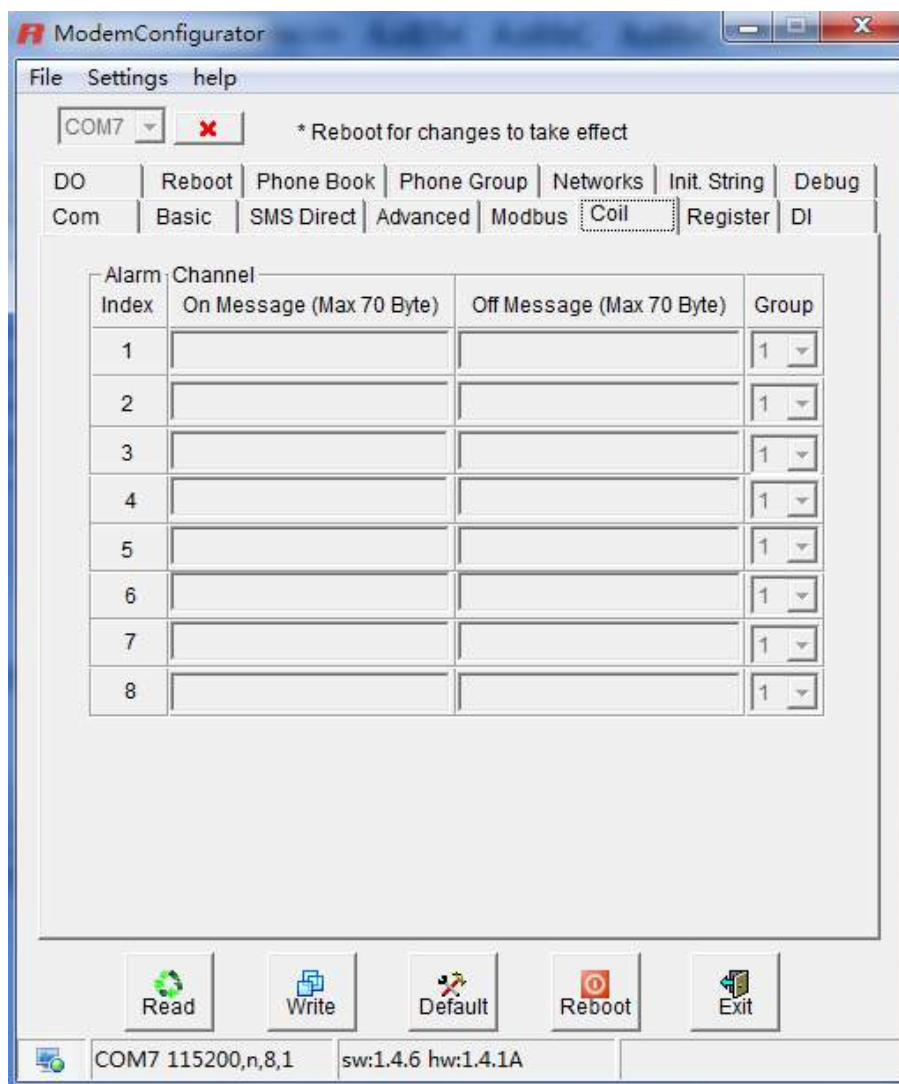

Coil		
Item	Description	Default
Index	Index 1 coil address=0x00 Index 2 coil address=0x01 Index n coil address=Index (n-1) coil address + 1	/
On Message	Send out SMS when coil value is 1. Input the SMS here. (70 ASCII char max)	Null
Off Message	Send out SMS when coil value is 0. Input the SMS here. (70 ASCII char max)	Null
Group	The SMS will send to specified phone group.	1

### 3.2.10 Register

This tab describes Register settings.

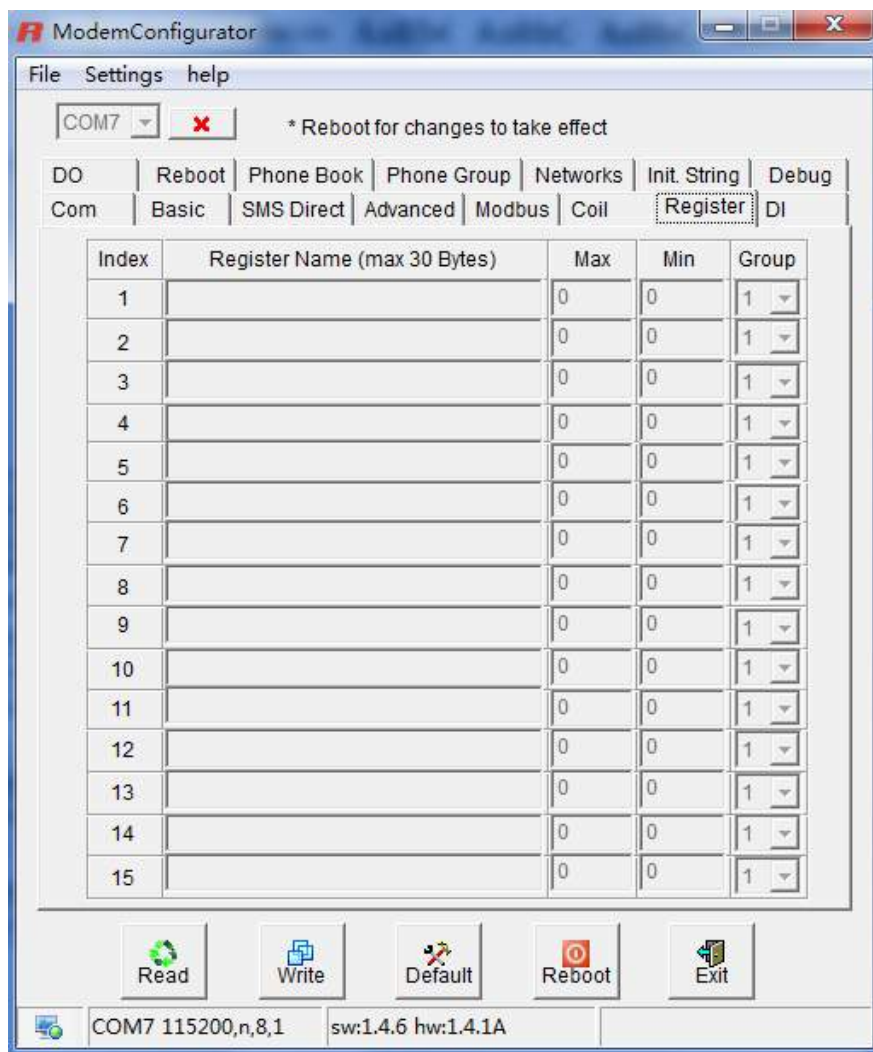

Register		
Item	Description	Default
Index	Index 1 register address=0x00 Index 2 register address=0x01 Index n register address=Index (n-1) register address + 1	/
Register Name	Input the register name. (30 ASCII char max)	Null
Max	Modem will send out alarm SMS when register current value is bigger than Max value. SMS content=Register Name+Current Value+Min to Max range	Null
Min	Modem will send out alarm SMS when register current value is smaller than Max value. SMS content=Register Name+Current Value+Min to Max range	Null
Group	The SMS will send to specified phone group.	1

### 3.2.11 DI

Type	Logic 0 (OFF)	Logic 1 (ON)
Dry contact	Close to GND	open

This tab describes the Digital Input settings.

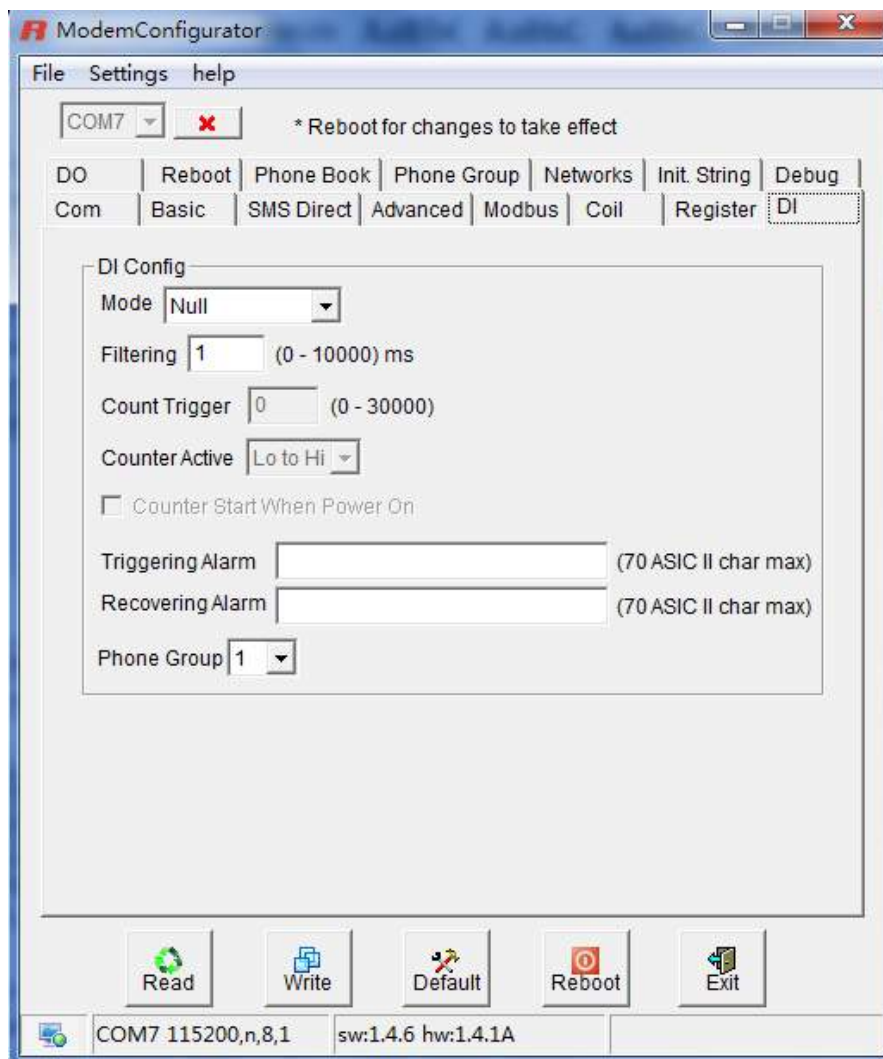

DI		
Item	Description	Default
Mode	<p>Mode refers to the status of a digital input channel.                      Selected from OFF, ON, OnChange, Event Counter and Null.                      OFF: is satisfied for as long as DI remains off                      ON: is satisfied for as long as DI remains on                      OnChange: triggering alarm when DI trigger the related action whether it is ON or OFF                      Event Counter: under event counter mode                      Null: DI disabled</p>	Null

Filtering	Software filtering is used to control switch bounces. Input from 0 to 10000ms.	0
Count Trigger	Available when DI under Event Counter mode. Input from 0 to 30000. (0=will not trigger alarm) It will trigger alarm when counter reaching this figure. After triggering alarm, DI keeps counting but will not trigger alarm again. To clear the counter, use SMS command or Modbus polling command. SMS command: please refer to 5.3 SMS Commands for Remote Control->Clear Event Counter Modbus address: please refer to 5.4 Modbus Address Mapping	0
Counter Active	Available when DI under Event Counter mode. In Event Counter mode, the channel accepts limit or proximity switches and counts events according to the ON/OFF status. When "Lo to Hi" is selected, the counter value increases when the attached switch is pushed. When "Hi to Lo" is selected, the counter value increases when the switch is pushed and released.	Lo to Hi
Counter Start When Power On	Available when DI under Event Counter mode. Start counting as soon as power on the modem when enable this option. If "Counter Start When Power On" is disabled, it will also start counting when receiving SMS command or Modbus polling command. SMS command: please refer to 5.3 SMS Commands for Remote Control->Start Event Counter Modbus address: please refer to 5.4 Modbus Address Mapping	Disable
Triggering Alarm	The SMS to receive upon triggering alarm. (70 ASCII char max)	Null
Recovering Alarm	The SMS to receive upon recovering alarm. (70 ASCII char max)	Null
Phone Group	The alarm SMS will send to specified phone group. Each phone group include up to 10 phone numbers.	Null
<b>Note:</b> the Event Counter value will be reset to zero if power is disconnected.		

### 3.2.12 DO

Type	Logic 0 (OFF)	Logic 1 (ON)
DO	open	short

This tab describes Digital Output settings.

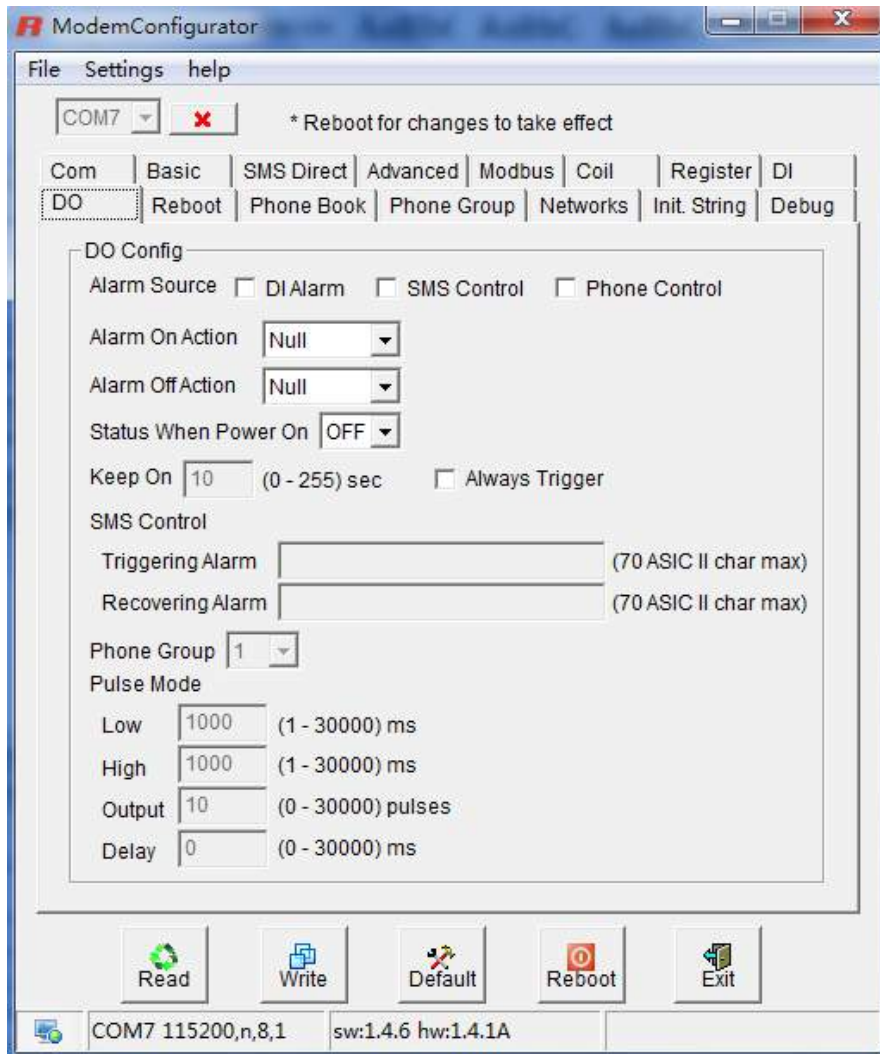

DO		
Item	Description	Default
Alarm Source	<p>Digital Output acts according to different alarm source. Selected from DI Alarm, SMS Control, Call Control, selection can be one or more.</p> <p>DI Alarm: Digital Output triggers the related action when there is alarm from Digital Input.</p> <p>SMS Control: Digital Output triggers the related action when receiving SMS from the number in the phone book.</p> <p>Call Control: Digital Output triggers the related action when receiving phone call from the number in the phone book.</p>	Null
Alarm On Action	<p>Digital Output acts when there is an alarm. Selected from OFF, ON, Pulse, Null.</p> <p>OFF: Open when triggered.</p> <p>ON: Short contact when triggered.</p> <p>Pulse: Generates a square wave as specified in the pulse mode</p>	Null

	parameters when triggered. Null: Do nothing.	
Alarm Off Action	Digital Output acts when alarm recovered. Selected from OFF, ON, Pulse, Null. OFF: Open when triggered. ON: Short contact when triggered. Pulse: Generates a square wave as specified in the pulse mode parameters when triggered. Null: Do nothing.	Null
Status When Power On	Specify the Digital Output status when power on. Selected from OFF, ON. OFF: Open. ON: Short contact.	Null
Keep On	Available when digital output Alarm On Action/Alarm Off Action status is ON, input the Digital Output keep on status time. Input from 0 to 255 seconds. (0=keep on until the next action)	0
Triggering Alarm	Available when enable SMS Control in Alarm Source. Input the SMS content to enable "Alarm On Action" by SMS. (70 ASCII char max)	Null
Recovering Alarm	Available when enable SMS Control in Alarm Source. Input the SMS content to enable "Alarm Off Action" by SMS. (70 ASCII char max)	Null
Phone Group	The alarm SMS will send to specified phone group. Each phone group include up to 10 phone numbers.	Null
Low	Available when enable Pulse in Alarm On Action/Alarm Off Action. In Pulse Output mode, the selected digital output channel will generate a square wave as specified in the pulse mode parameters. The low level widths are specified here. Input from 1 to 30000 ms.	1
High	Available when enable Pulse in Alarm On Action/Alarm Off Action. In Pulse Output mode, the selected digital output channel will generate a square wave as specified in the pulse mode parameters. The high level widths are specified here. Input from 1 to 30000 ms.	1
Output	Available when enable Pulse in Alarm On Action/Alarm Off Action. The number of pulses, input from 0 to 30000. (0 for continuous pulse output)	1
Delay	Available when enable Pulse in Alarm On Action/Alarm Off Action. The first pulse will be generated after a "Delay". Input from 0 to 30000ms. (0=generate pulse without delay)	0

### 3.2.13 Reboot

Since cellular network is not as stable as fixed line, Robustel M1000 series modems support various auto reboot function to keep modem working 24x7 without hang up.

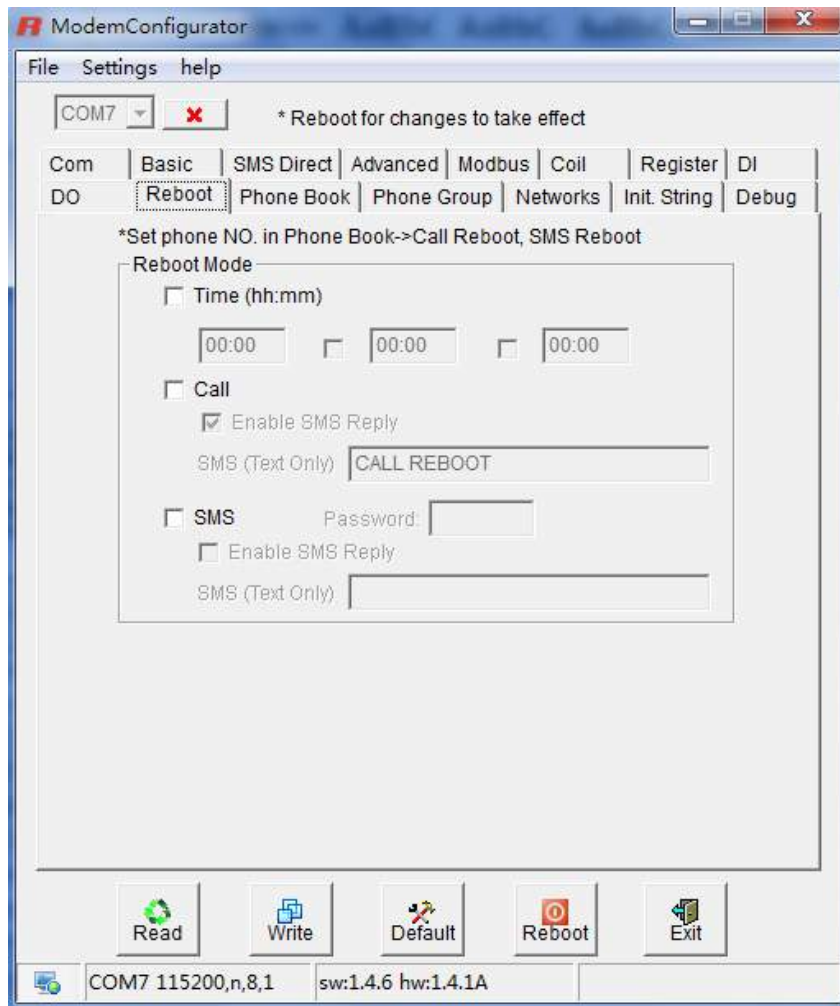

#### Reboot

**Note: This function is available under both "Config Mode" and "Normal Mode".**

Item	Description	Default
Time	Tick the <b>Time</b> checkbox to allow modem auto reboot with preset time schedule every day, support maximum 3 time schedule/day (e.g. 07:00, 11:00 and 23:30 every day).	Disable
Call	Tick the <b>Call</b> checkbox to allow modem auto reboot with incoming call from specified <b>Caller ID</b> (phone number). The <b>Caller ID</b> (phone number) should be specified in " <b>Phone Book</b> " tab by inputting the phone number and tick " <b>Call Reboot</b> " checkbox.	Disable
SMS	Tick the <b>SMS</b> checkbox to allow modem auto reboot with incoming specified short message from specified <b>Caller ID</b> (phone number). Specified short message is set at <b>Password</b> item. (e.g. reboot)	Disable



	The <b>Caller ID</b> (phone number) should be specified in “ <b>Phone Book</b> ” tab by inputting the phone number and tick “ <b>SMS Reboot</b> ” checkbox.	
Enable SMS Reply	Tick the <b>Enable SMS Reply</b> checkbox to allow modem send reply short message after auto reboot by Call Reboot or SMS Reboot from specified <b>Caller ID</b> (e.g. Reboot ok!). <i>Note: Only support text format SMS.</i>	Disable

**Note:**

1. Time format for Time reboot is 24-hours.
2. The phone numbers for **Call** and **SMS** function can be set in Phone Book tab.
3. The **Caller ID** must be written in international format, starting with “+” followed by the country code.
4. If you leave **Caller ID** blank, the modem will reboot with any incoming call, which may cause unexpected issue. It is highly recommend setting the **Call ID**.

### 3.2.14 Phone Book

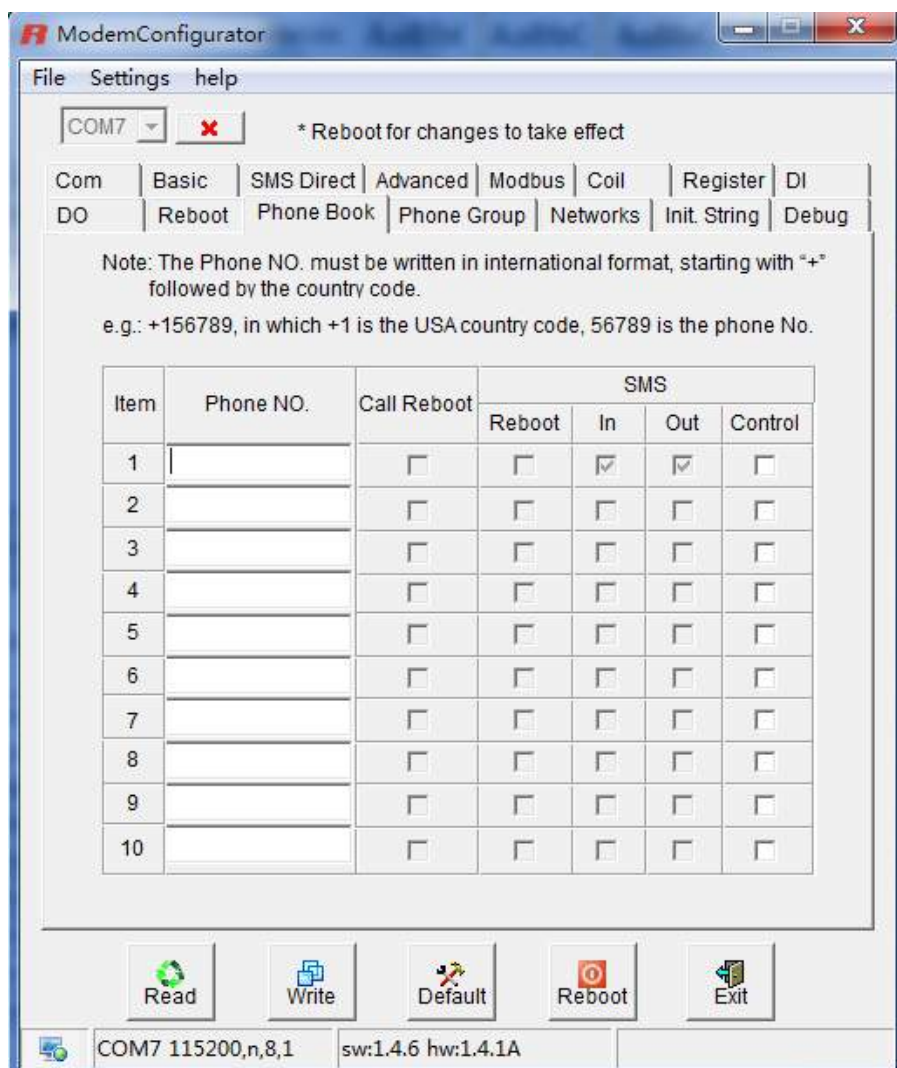

Phone Book		
Item	Description	Default
Phone NO.	Input the telephone number.	N/A
Call Reboot	Tick the <b>Call Reboot</b> checkbox to allow modem auto reboot with incoming call from this number.	Disable
SMS Reboot	Tick the <b>SMS Reboot</b> checkbox to allow modem auto reboot with incoming specified short message from this number.	Disable
SMS In	Tick the <b>SMS IN</b> checkbox to allow forwarding of incoming short messages from this number to the modem's serial port as data.	Disable
SMS Out	Tick the <b>SMS OUT</b> checkbox to allow data received from the attached serial device to be transmitted as short messages to this number.	Disable
SMS Control	Tick the <b>SMS Control</b> checkbox to allow this number the following privileges: 1. SMS commands for remote control 2. Receive Auto SMS report every day after enable	Disable
<b>Note:</b> The <b>Phone NO.</b> must be written in international format, starting with "+" followed by the country code.		

### 3.2.15 Phone Group

Phone Group is only available for DI, DO, Coil and Register tabs.

Select different phone numbers to include them in the same phone group.

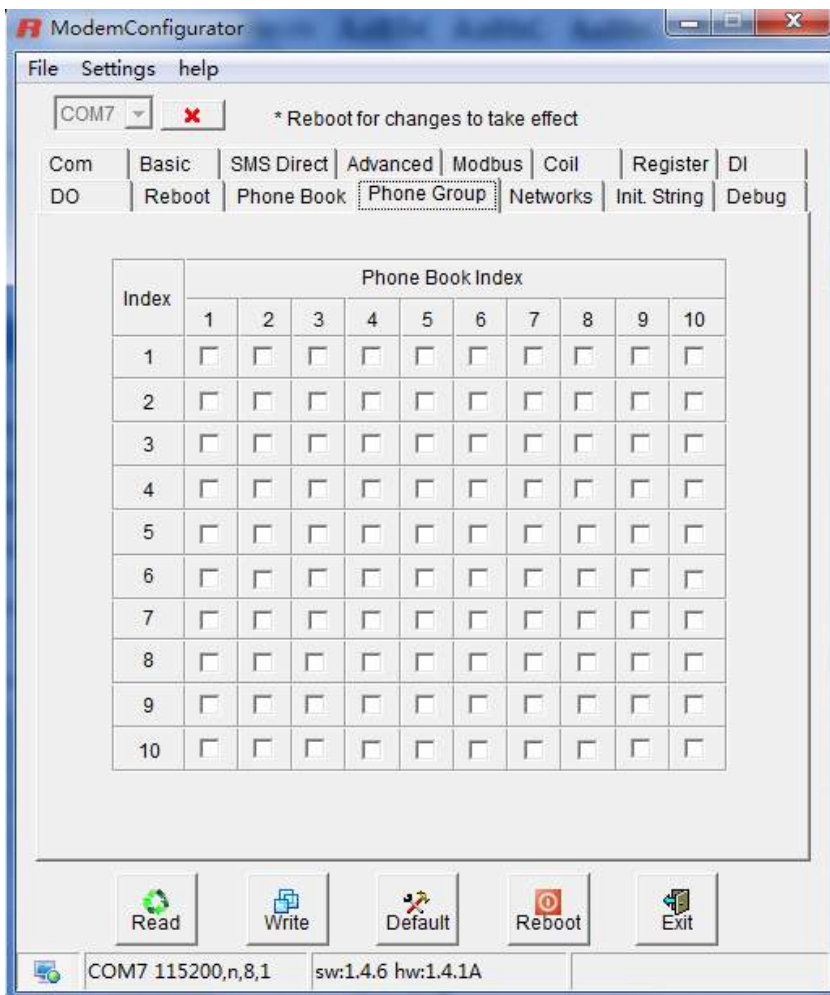

### 3.2.16 Networks

This tab allows user to check the network status of the Modem.

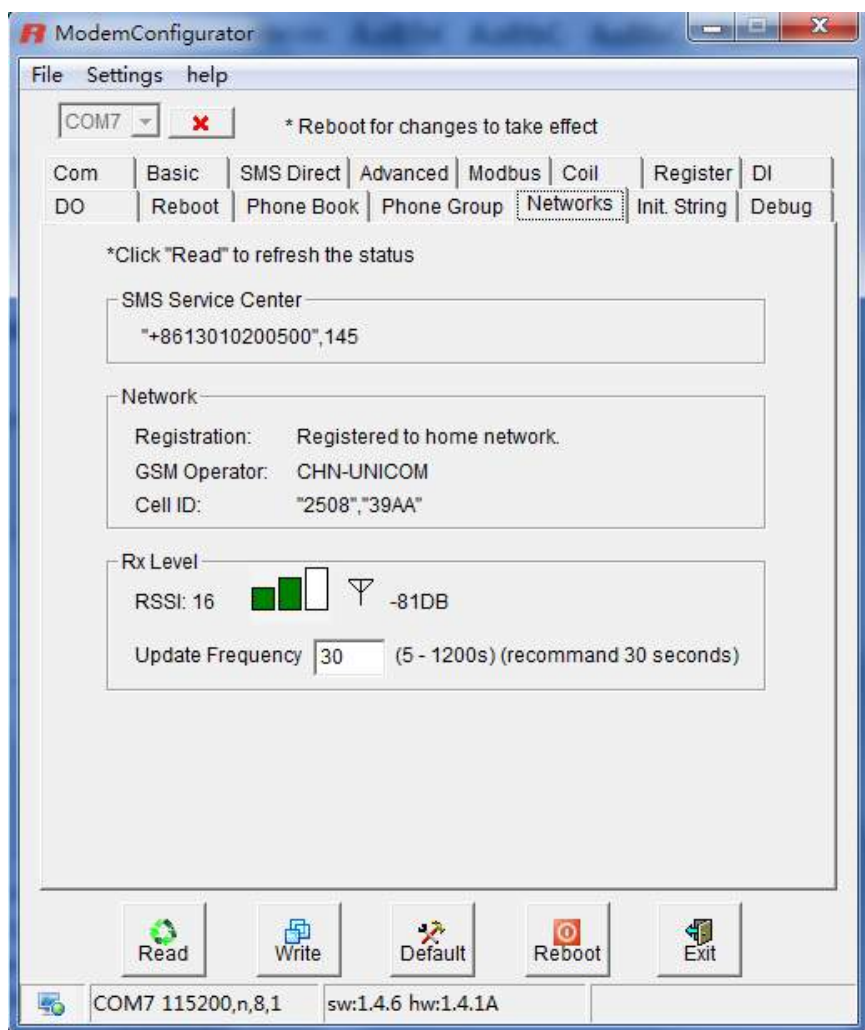

**Networks**

Item	Description	Default
SMS Service Center	Read the Short Message service center.	Read SMS Service Center from SIM card
Registration	Show the modem current registration status. There are 3 status: 1. Not registered 2. Registered, home network 3. Registered, roaming	N/A
GSM Operator	Show the modem current registered GSM operator name.	N/A
Cell ID	Show the modem current register base station cell ID.	N/A
RSSI	Show the modem current RSSI from 0 to 31 and corresponding DB.	N/A
Update Frequency	The modem's 3 levels RSSI indicators will vary according to network status by preset interval.	30 seconds

**Note:**

1. Usually modem can read the **SMS Service Center** from SIM Card, no need to modify or set a new SMS Service

Center unless it the modem cannot read it from the SIM Card.

2. Click “Read” to refresh the “**Network**” and “**Rx Level**” status.

Values of received signal strength (RSSI)

Value of received signal strength indication (RSSI)	Interpretation of the received signal strength
0 to 12	Insufficient or weak
13 to 19	Average
20 to 31	Good
99	No signal

**Note:** RSSI should remain higher than 12 to create/accept GSM CSD data calls or establish a GPRS connection. Users can only transmit/receive by SMS (short message) if the RSSI is less than or equal to 11.

A better way of verifying the RSSI signal (instead of using the Modem Configuration) is to check the “**SIGNAL**” LEDs on the front panel directly. See [2.2 LED Indicators](#) for more information.

Antenna selection guide

Value of received signal strength indication (RSSI)	Antenna selection
0 or 1	GSM/GPRS is not good solution in the area
$1 < \text{RSSI} \leq 12$	Select antenna gain > 10 dBi
$12 < \text{RSSI} < 20$	Select antenna gain > 3 to 5 dBi
$\geq 21$	Select antenna gain > 0 to 3 dBi

### 3.2.17 Init. String

User could enter the initial string in the text input box.

The preset **Init. String** will take effect under “**Normal Mode**”.

**Note:** Maximum 39 characters for each initial string.

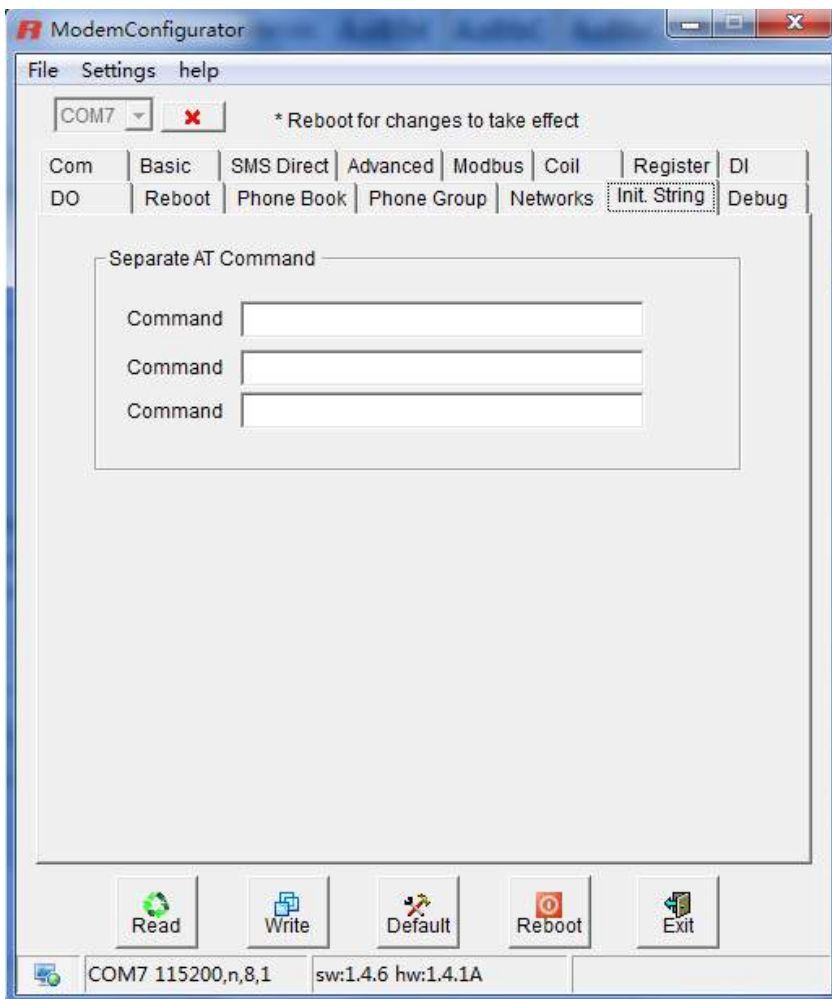

### 3.2.18 Debug (Only Available under “Normal Mode”)

In this tab, user could change serial port baud rate in **Normal Mode**. Please operate according to follow steps to change baud rage (default baud rate is 115200 bps, in this case we want to change baud rate to 19200 bps):

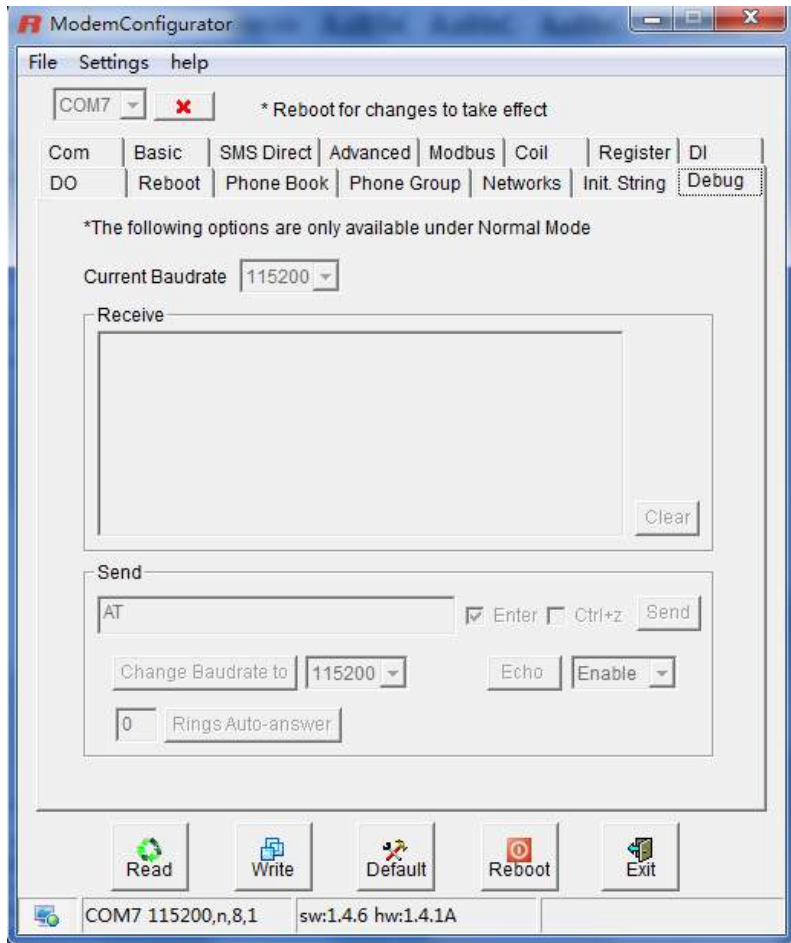

**Debug**

Item	Description	Default
“Receive” windows	Display the command replied by the cellular module after sending the AT commands	N/A
“Send” windows	Input the AT commands in this windows	AT
Enter	The same as “Enter” in windows Hypter Terminal, click to enable or disable	Enable
Ctrl+z	The same as “Ctrl+z” in windows Hypter Terminal, click to enable or disable	Disable
Echo	Enable or Disable the Echo. <b>Note:</b> 2-wire RS-485 uses half-duplex communication. For this reason, the modem’s local echo should be disabled.	Enable
“Send” button	Click to send out the AT commands and in “Send” windows	N/A
Clear	Click to clear the “Receive” windows	

1. Select 19200 bps, then click “**Change Baudrate to**”, after that **Current Baud Rate** will also auto change to 19200 bps (it will auto display “AT+IPR=19200” and “OK” in Receive windows);

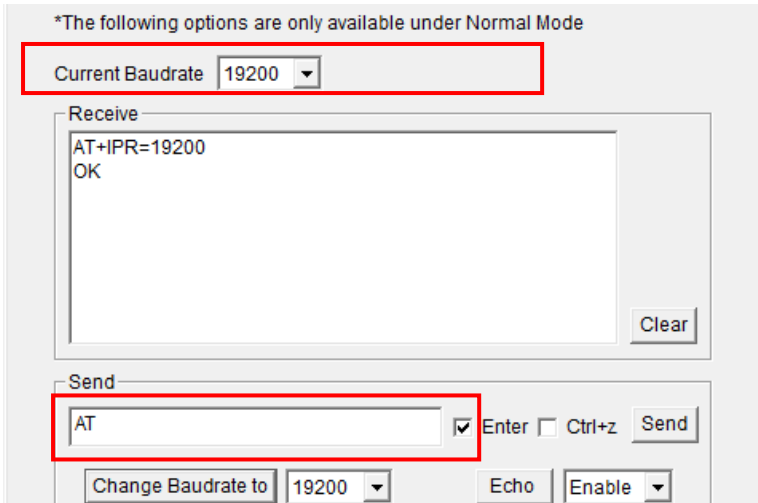

2. Test AT commands. Here we send “AT” then modem will reply “OK”.

**Note:**

1. Please disconnect the COM connection, after that switch from **Config Mode** to **Normal Mode**, and then and then connect again to the COM.
2. **Receive** windows is a simple Hyper Terminal Emulator.

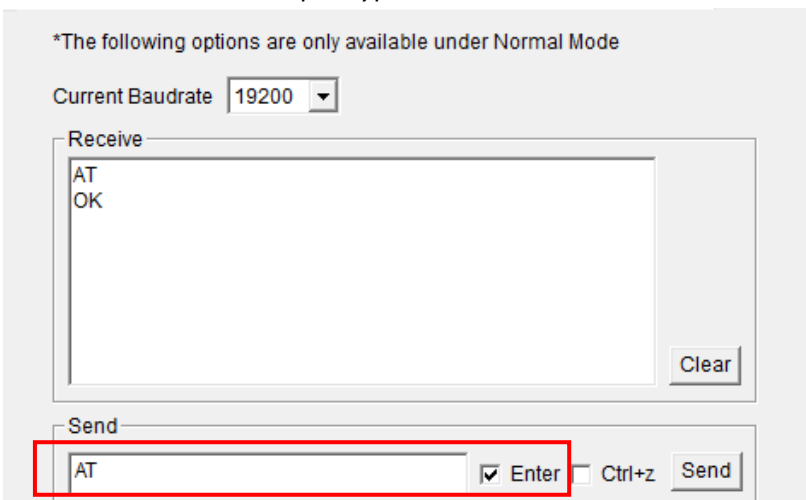

In this tab, user could also set “auto-answer” for CSD communications. It is much easier to activate Auto-answer using Modem Configurator. Input the number of rings, for example input 1, and then click “Rings Auto-answer”.

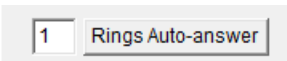

If there is an incoming CSD call, modem will auto answer after 1 ring tone.



## Chapter 4. Typical Applications

### 4.1 AT Command Set (Only Available under Normal Mode)

The modem supports the guidelines known as the “AT Command Set.” The AT Command Set is the industry standard line-oriented command language used to communicate with the modem.

**Note:** AT Commands may be entered from terminal software such as Robustel Modem Configurator’s Debug Tab or Windows HyperTerminal.

#### 4.1.1 Starting Robustel Modem Configurator

Please refer to [Debug \(Only Available under “Normal Mode”\)](#) and find out how to send AT Commands by the Modem Configurator.

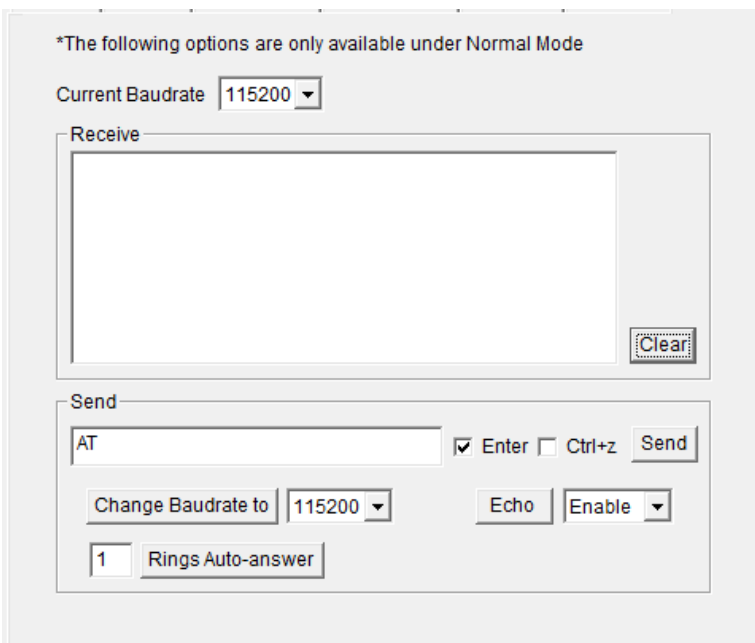

#### 4.1.2 Starting Windows Hyper Terminal

User could also control modem via AT Commands by Windows Hyper Terminal.

1. Go to “Windows Start->All Programms->Accessories-Communications>HyperTerminal” and click to open.
2. Establish a new connection and input the connection name.

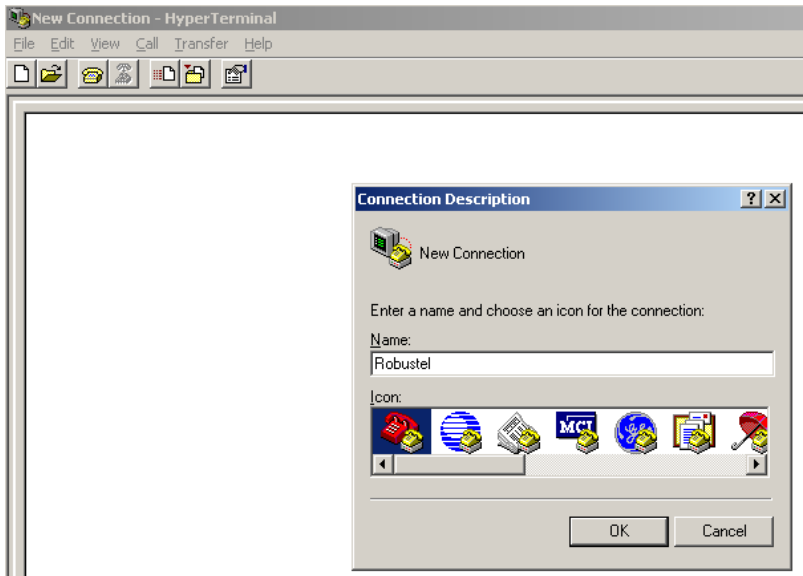

3. Select the right COM port (i.e. COM7) and baud rate settings (115200, 8bits, none parity, 1 stop bit, no flow control).



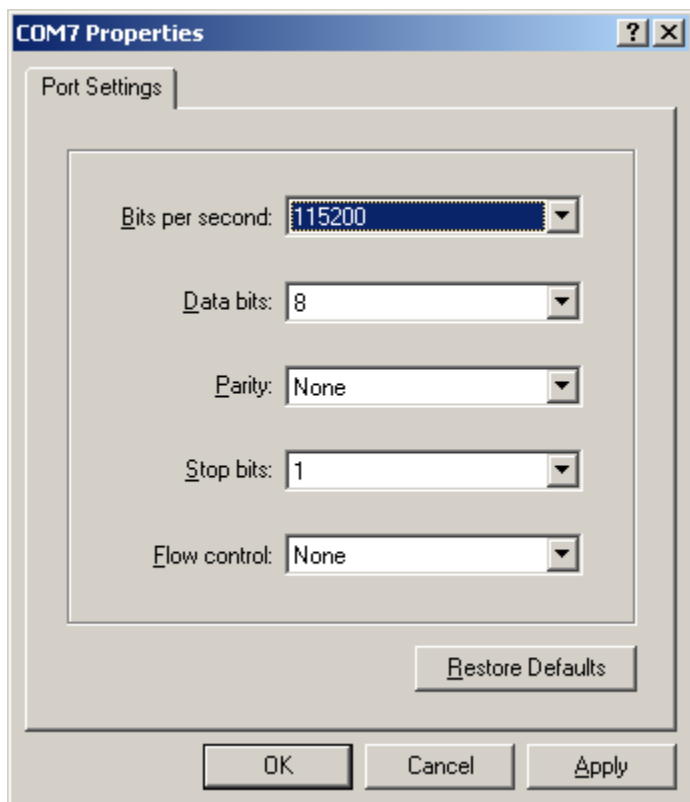

4. Input AT commands on the HyperTerminal screen (e.g. type “AT” to check the “OK” response from the modem).

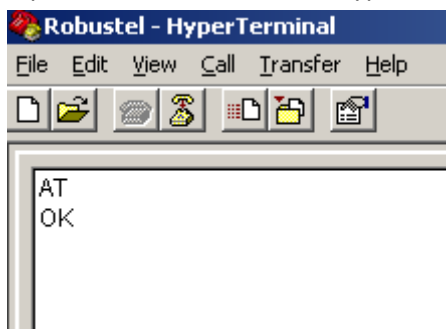

### 4.1.3 AT Commands Examples

Followings are examples of some AT commands. Please refer to the AT command guide for a full description.

Description	AT commands	Modem response	Comments
Receiving signal strength	AT+CSQ	+CSQ: 19,99	The first parameter has to be at least 15 for normal communication.
Saves parameters in non-volatile memory	AT&W	OK	The configuration settings are stored.

## 4.2 GSM CSD Connection (Only Available under Normal Mode)

### 4.2.1 Overview

A Circuit-Switched Data Connection makes the wireless modem work in a manner similar to a regular analog modem. CSD (Circuit Switched Data) is the original form of data transmission developed for GSM systems. By using a single radio time slot, CSD is able to deliver 9.6 to 14.4 kbit/s data transmission to both the GSM Network and PSTN Switching Subsystem through direct calls. Most of the time, it is initiated by standard AT commands. Using the modem to access remote devices by CSD is often more convenient than installing cables and data lines. Data collection and monitoring will be more flexible since CSD can be used for applications that are hard to wire or hard to access.

**Note:** Ensure that your SIM card has the CSD Service activated. For most regions, you must apply to your mobile service provider to receive this service.

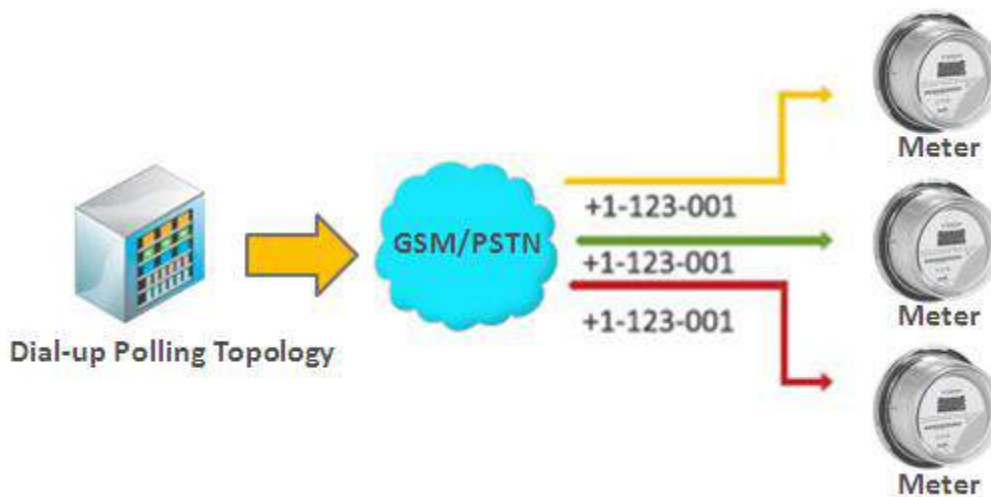

### 4.2.2 Establishing a CSD Connection

1. Enable **CSD** at Basic Tab under **Normal Mode**;

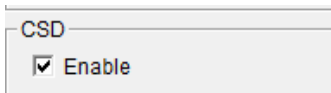

2. Start Modem Configurator and click the Debug tab under **Config Mode**, with the current communication parameters (default: 115200 bps, 8 for Data bits, None for Parity, 1 for Stop bits, and None for flow control).
3. Type **ATD <phone number>** and click **Send** to establish a CSD connection. (e.g. ATD 123456, in which 123456 is the phone number.)
4. After remote side answering the CSD call, then the CSD connection has been established successfully, and you can switch to data mode to proceed with data communication.

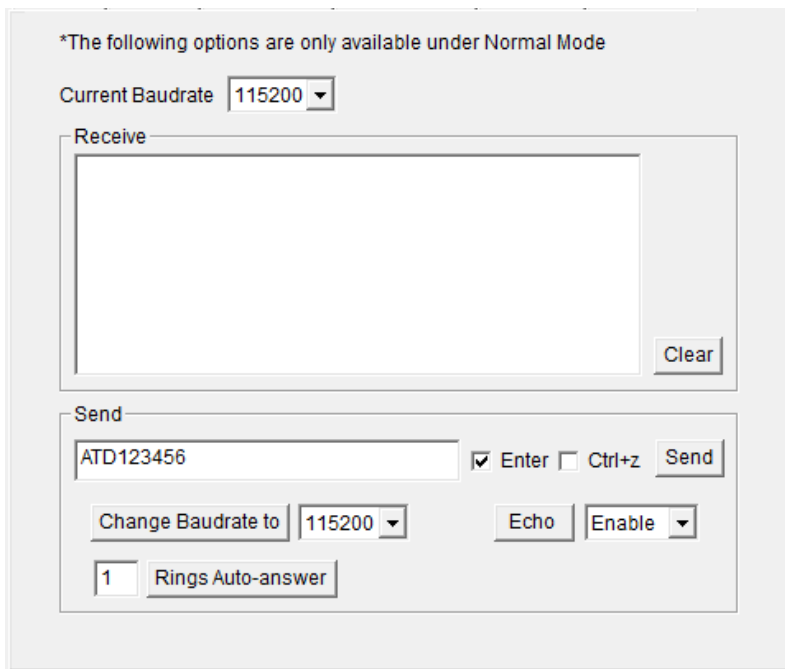

- To disconnect the connection, type **+++** in **Send** windows and enable **Enter**, then click **Send**. The modem will respond with **OK** to indicate that you have already switched back to the command mode.

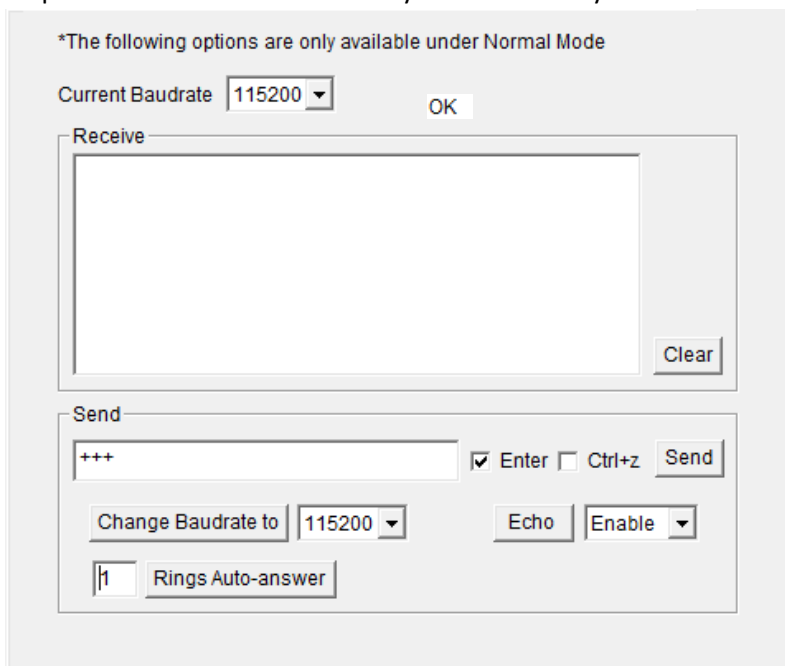

- Type **ATH** and then press **Enter** to disconnect.



**Note:**

1. **+++** is the escape sequence, and **ATH** is the hang-up command.
2. For international calls, the local international prefix does not need to be set, but does need to be replaced by the **+** character. E.g., you would type **ATD+86123456**, in which **+86** is the country code.
3. User could also establish a CSD connection by using terminal software such as Windows HyperTerminal, or Robustel Modem Configurator's Debug Tab.

### 4.2.3 Answering a CSD Connection

1. To answer a call manually, when the Modem Configurator displays the RING response, type to answer a call manually, when the Modem Configurator displays the RING response, type **ATA** , enable **Enter** and click **Send**.

\*The following options are only available under Normal Mode

Current Baudrate 115200

Receive

```
RING
RING
RING
ata
```

Clear

Send

ATD123456  Enter  Ctrl+z Send

Change Baudrate to 115200 Echo Enable

1 Rings Auto-answer

2. After the CSD connection has been established, and the modem will be in the data mode. At this point you can proceed with data communication.
3. To answer a call automatically, type **ATS0=x** and click **Send**, and then type **AT&W** and click **Send** in the Modem Configurator. In this case, replace **x** with the number of rings that the modem receive before answering the call.

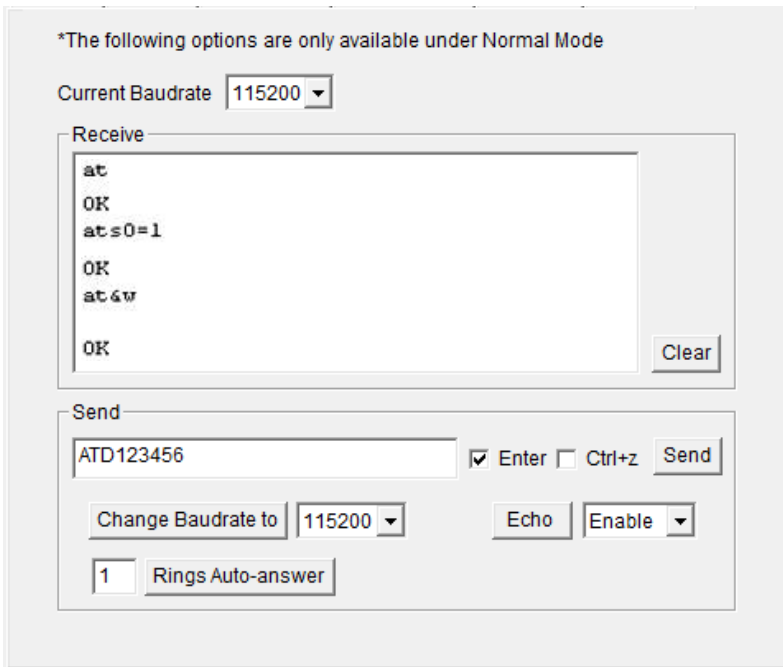

**Note:**

1. **ATA** is the Answer command. **ATS0=<x>** is the auto-answer command. The **AT&W** command helps to save the current settings to the modem.
2. It is much easier to activate Auto-answer using Modem Configurator. Input the number of rings to wait in the input box and then click **Rings Auto-answer**.

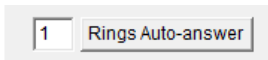

3. To disconnect the modem, type **+++**. The modem will respond with **OK**, which means that you have already switched back to command mode.
4. Type **ATH** and press **Enter** to disconnect.

### 4.3 Using Short Message Service by Using AT Commands (Only Available under Normal Mode)

GSM technology offers the benefit of using SMS (short message service) as an easy way to communicate over the mobile network.

The following topics are covered in this chapter:

1. Sending a Short Message
2. Reading a Short Message
3. Deleting a Short Message

**Note:** Please enable the following option under Config Mode, then switch back to Normal Mode.

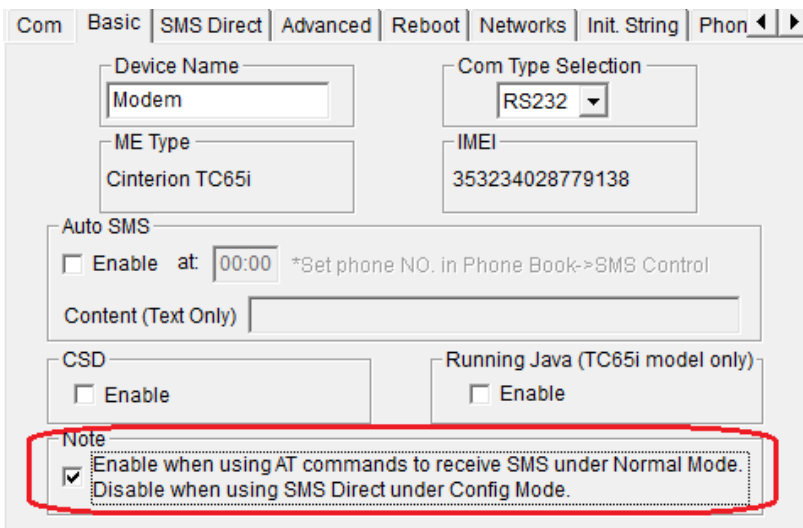

Com Basic SMS Direct **Advanced** Reboot Networks Init. String Phon

Device Name: Modem  
Com Type Selection: RS232

ME Type: Cinterion TC65i  
IMEI: 353234028779138

Auto SMS  
 Enable at: 00:00 \*Set phone NO. in Phone Book->SMS Control  
Content (Text Only):

CSD  Enable  
Running Java (TC65i model only)  Enable

Note  
 Enable when using AT commands to receive SMS under Normal Mode.  
Disable when using SMS Direct under Config Mode.

### 4.3.1 Sending a Short Message

1. Type **AT+CMGF=1** and then click **Send**.
2. Type **AT+CMGS="<phone number>"** and then click **Send**. The terminal will automatically move to the next line, which starts with >. Type your message to the right of the >.
3. Enable **Ctrl + Z** and click **Send** to deliver the message.

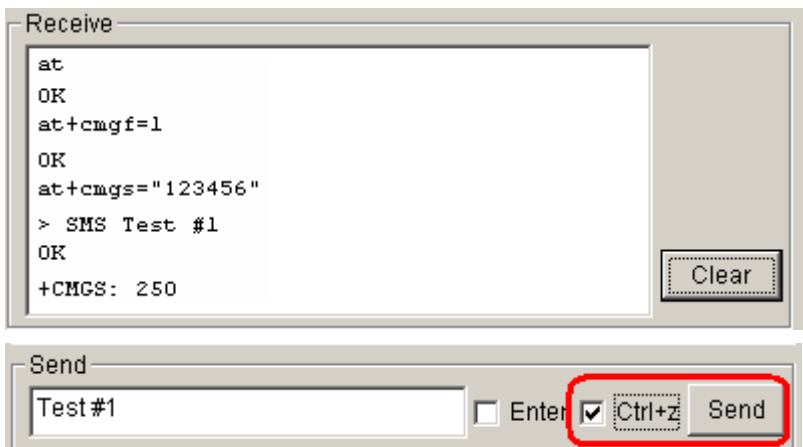

Receive

```
at
OK
at+cmgf=1
OK
at+cmgs="123456"
> SMS Test #1
OK
+CMGS: 250
```

Send

Test#1  Enter  Ctrl+z **Send**

**Note:** *AT+CMGF=1 sets the SMS to Text mode.*

### 4.3.2 Reading a Short Message

1. Type **AT+CMGF=1** and then press **Enter**.
2. Type **AT+CNMI=2,1** and then press **Enter**.
3. When a short message is received, the modem will show the storage number of the message after **"+CMIT: "SM", x"** (where the **x** is the storage number).
4. Type **AT+CMGR=x** to read the message.
5. In the example shown below, the **x=5** means that the message is stored in the 5th storage location.



```
at
OK
+CMTI: "SM",5
at+cmgr=5
+CMGR: "REC UNREAD","+886972613404",,"07/03/19,00:36:24+32"
SMS Test #1
OK
```

### 4.3.3 Deleting a Short Message

Type **AT+CMGD=*x*,*n*** and then press **Enter**.

This is where *x* represents one of the following options:

- “**REC UNREAD**” Shows received unread messages.
- “**REC READ**” Shows received read messages.
- “**STO UNSENT**” Shows stored unsent messages.
- “**STO SENT**” Shows stored sent messages.
- “**ALL**” Shows all messages.

This is where *n* represents one of the following options:

- 0** Delete message at location <include the index number>
- 1** Delete all READ messages.
- 2** Delete all READ and SENT messages.
- 3** Delete all READ, SENT, and UNSENT messages.
- 4** Delete ALL messages. “**REC UNREAD**” Shows received unread messages.

**Note:** Refer to the Documentation and Software CD / AT\_Commands / AT\_Commands.pdf for further detail commands information using SMS.

## 4.4 Using SMS Direct (Only Available under Config Mode)

Robustel’s proprietary SMS Direct Mode has the following features:

1. Transparently converts serial data to short message or vice versa **without using AT Commands**.
2. Text, binary, and Unicode formats are supported.
3. Verification of Incoming Caller ID is implemented to block uncertified users.
4. The configuration profile can be easily stored, and then copied to other modems.

Please refer to [3.2.5 SMS Direct](#).

## 4.5 GPRS Connection (Only Available under Normal Mode)

### 4.5.1 Overview

GPRS is a packet-switched technology, which means that multiple users share the same transmission channel. In addition, GPRS transmits only when there is outgoing data. This means that the available bandwidth can be dedicated solely to data communication when needed. In general, a GPRS network can be viewed as a special IP network that offers IP connectivity to IP terminals. Devices such as PCs, embedded computers, and PLCs that are PPP-enabled can be easily connected to the IP network and the Internet.



The modem provides multi-slot Class 10, which means that there are **4 Rx** timeslots plus **1 Tx** timeslot, or **3 Rx** timeslots plus **2 Tx** timeslot. The CS-1 to CS-4 Coding Schemes must be supported by the provider. GPRS offers no guaranteed data rates or bandwidth. The value assigned by the provider (coding scheme and timeslots) can change dynamically during a connection.

In general, for the **1 Tx + 4 Rx** combination, the **Tx** throughput is around 8-12 Kbps when the **Rx** throughput is around 32-48 Kbps.

For the **2 Tx + 3 Rx** combination, the **Tx** throughput is around 16-24 Kbps when the **Rx** throughput is around 24-36 Kbps.

### 4.5.2 Windows GPRS Access

The modem can use Windows DUN (Dial-up Networking) to provide the Internet access through the GPRS mobile network. Instructions are described in the following chapters.

**Note:** *The specific steps may vary depending on your version of Windows and your Windows settings.*

#### Set Modem Baud Rate to 19200 bps under Normal Mode

1. Select 19200 bps, and then click "Change Baudrate to";

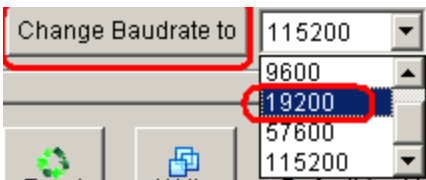

2. Exit the Modem Configurator.

**Note:** *Please make sure your COM port connecting to the modem is free and do not be used by any software or application (e.g. **Modem Configurator**).*

**Installing the Modem Driver**

1. In the Control Panel, open “Phone and Modem Options” and click the “Modem” tab. Click **Add** to add a new modem.

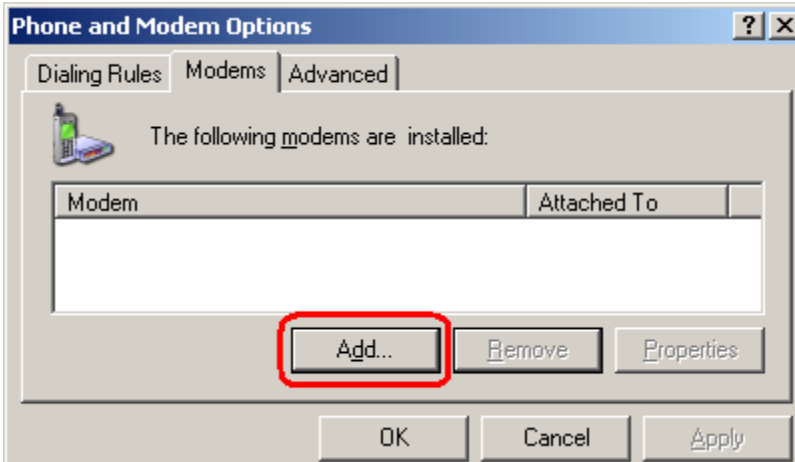

**Note:** The first time you access the **Phone and Modem Options**, Windows will ask you to input the area code. Enter the area code to proceed.

2. When the Install Mode window opens, select **Don't detect my modem, I will select it from a list** and then click **Next**.

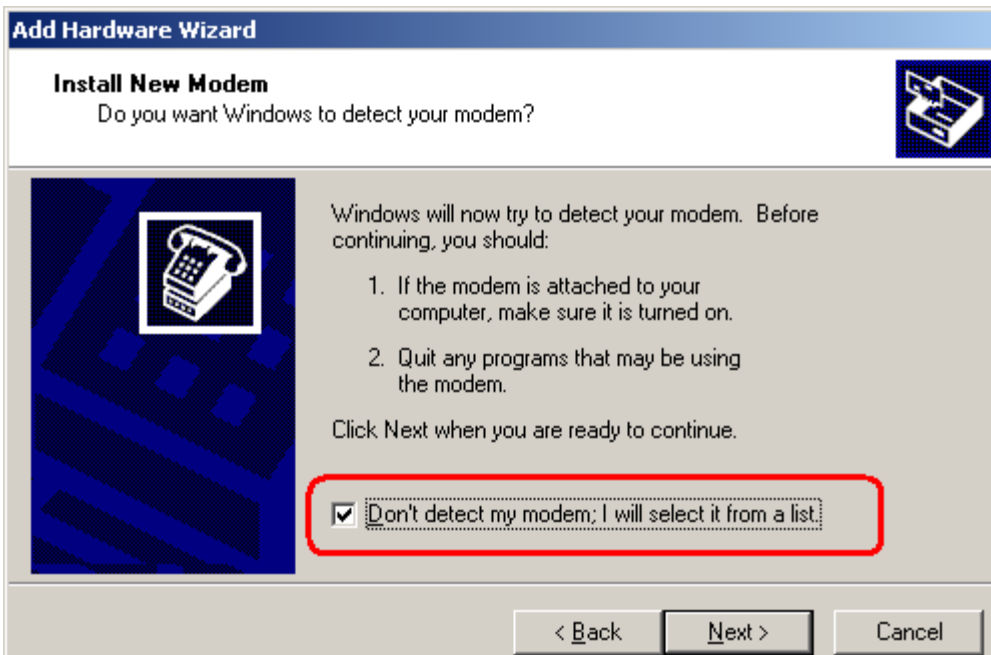

3. Next, click **Standard Modem Types->Standard 19200 bps Modem**, and then click **Next**.

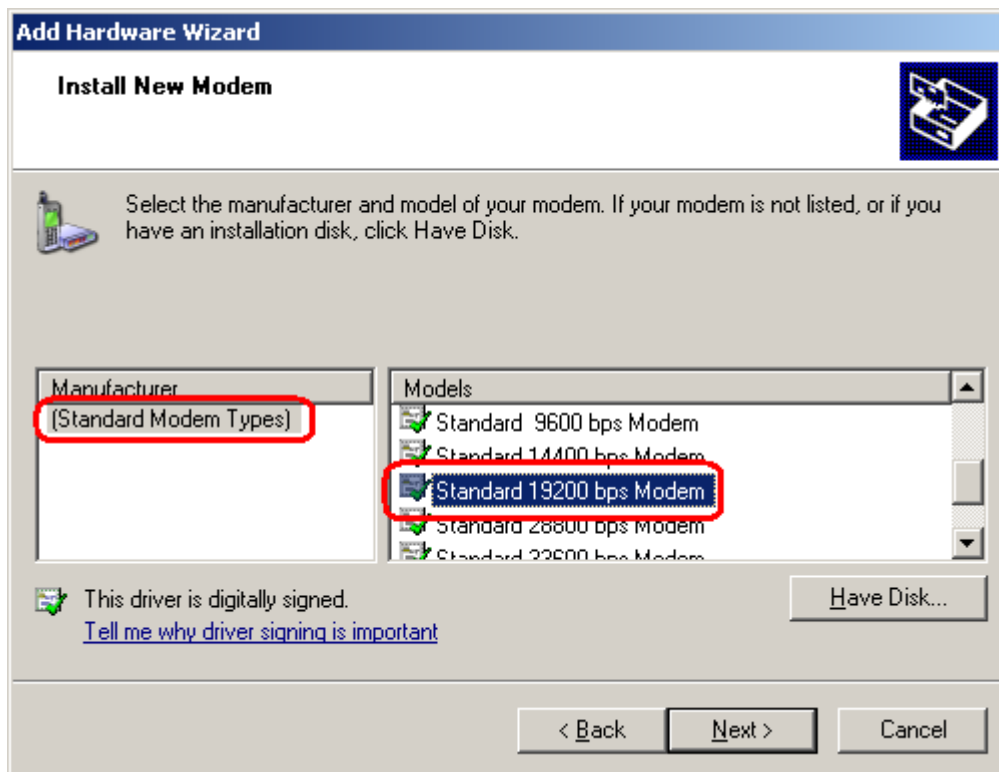

4. Select the port you want to install the modem on, we select **COM7** here, then click **Next**.

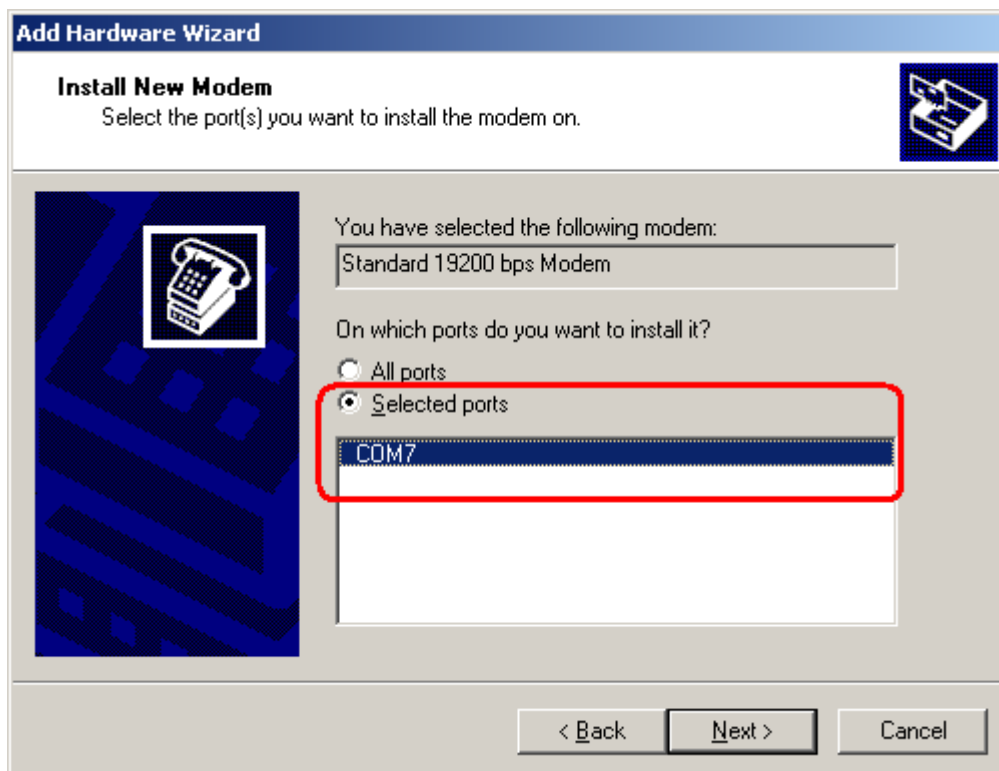

5. The modem installation is finished, click **Finish**.

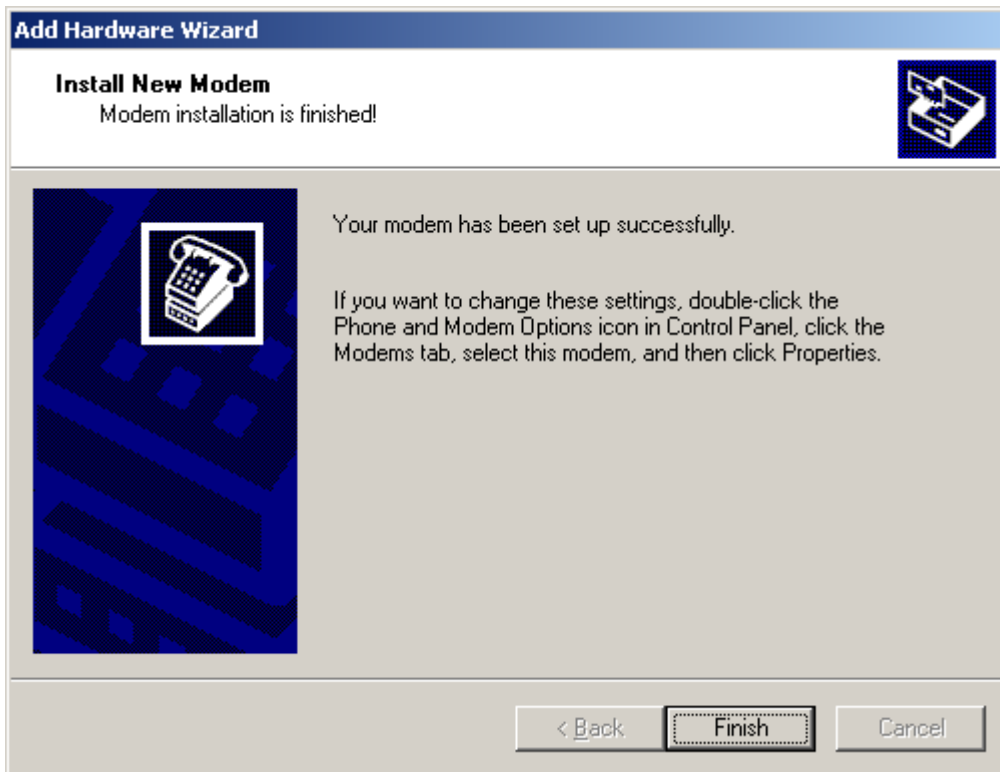

6. At this point, the modem driver should be listed on the “Modems” tab under “Phone and Modem Options.”

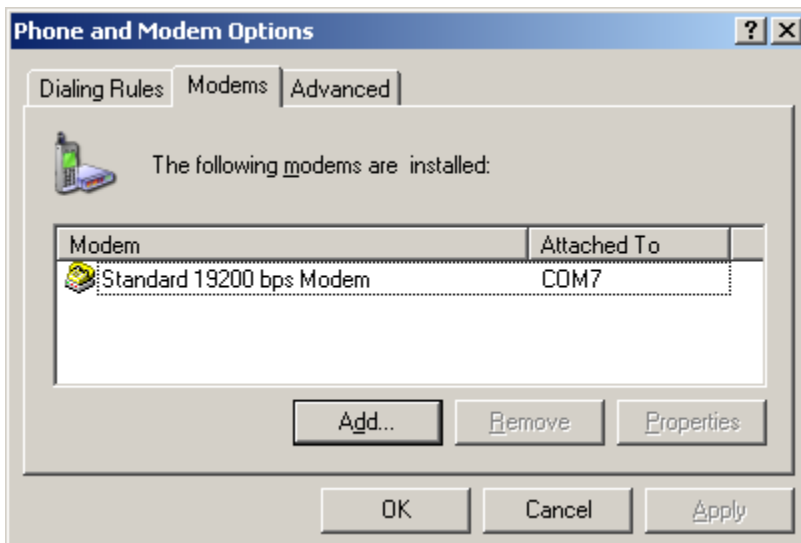

### Modem Diagnostics

Follow these steps to verify that the modem is installed properly and has been activated.

1. From the Control Panel, open **Phone and Modem Options**, click the **Modem** tab, and then click **Properties**.

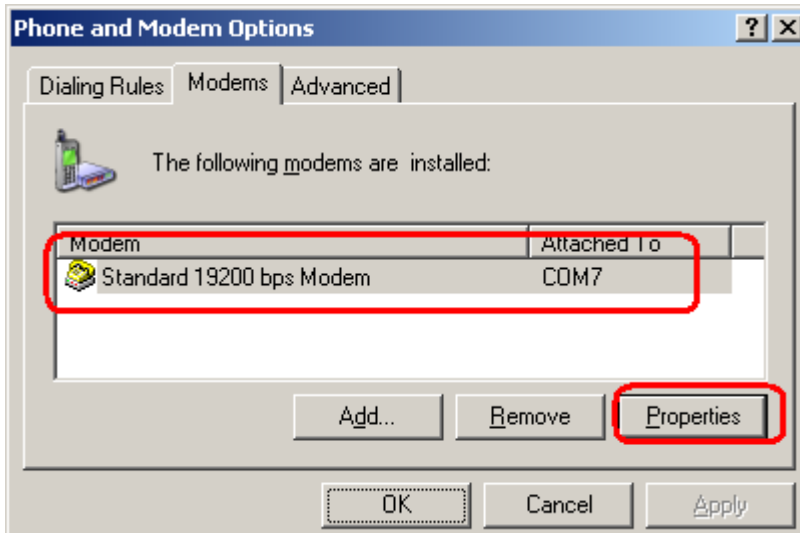

2. Click the **Diagnostics** tab, and then click **Query Modem**.

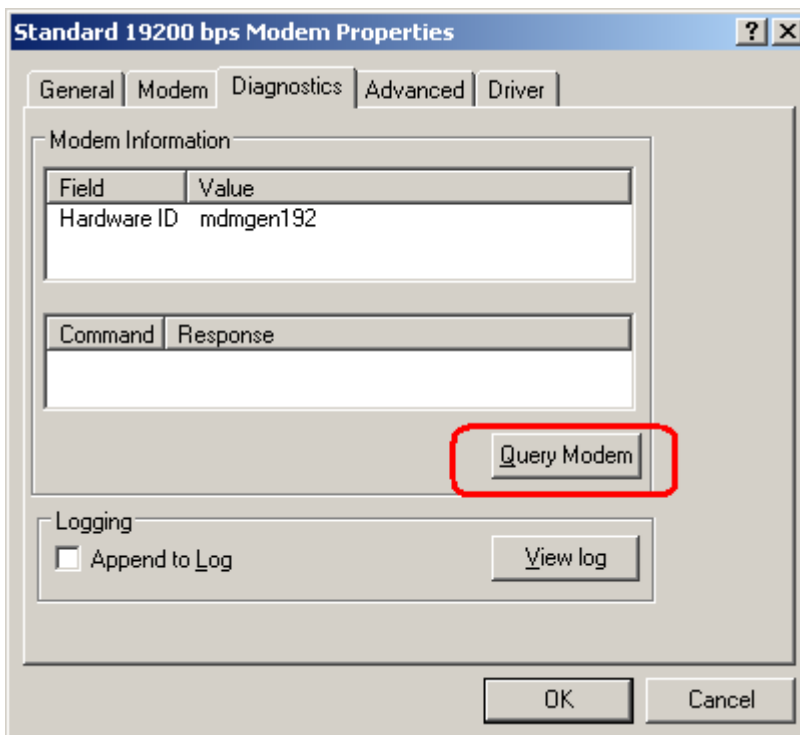

3. If the query is successful, both commands to the modem and responses from the modem will be displayed.

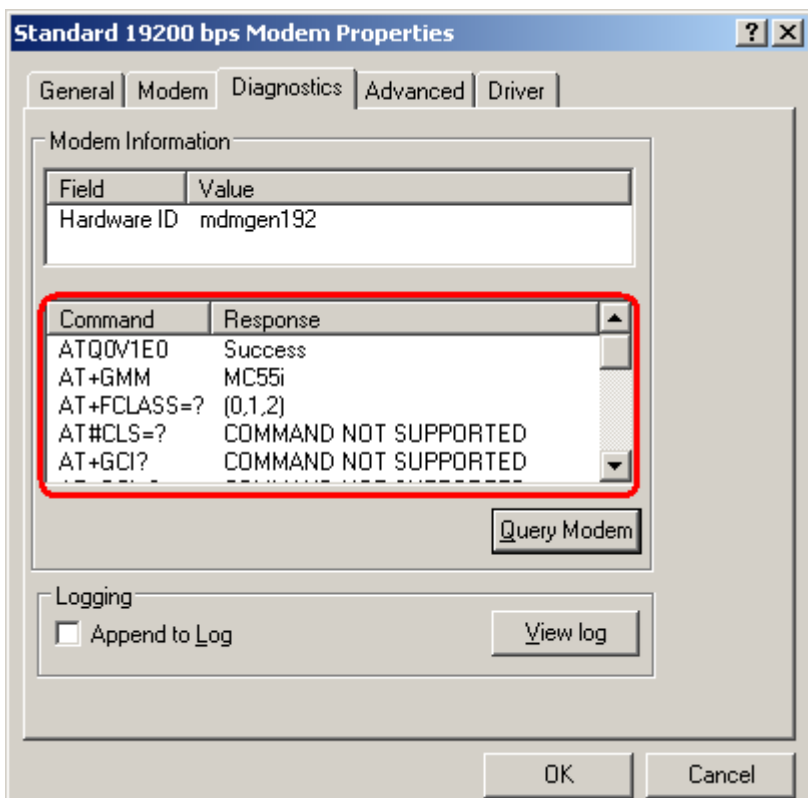

### Setting up the APN

Before using the GPRS on the Windows DUN, the APN (Access Point Name) must be added as a modem initialization command. Detailed instructions are shown below.

1. From the Control Panel, open **Phone and Modem Options**, click the **Modem** tab, and then click **Properties**.

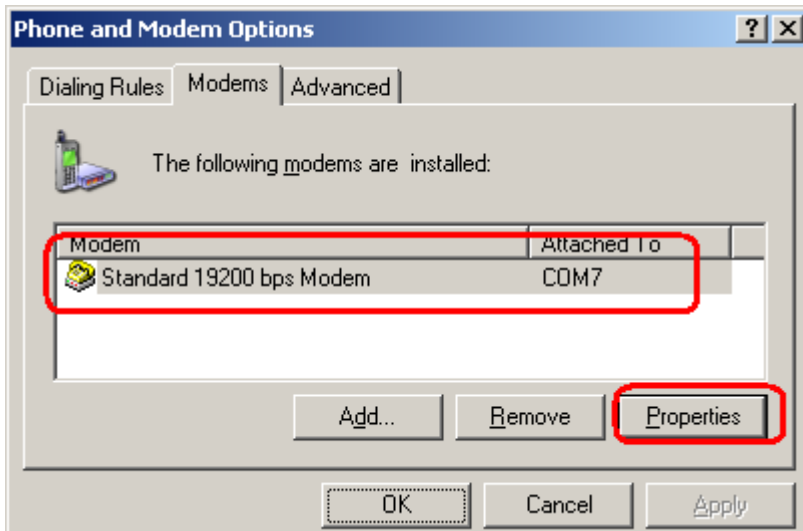

2. Click the **Advanced** tab next.

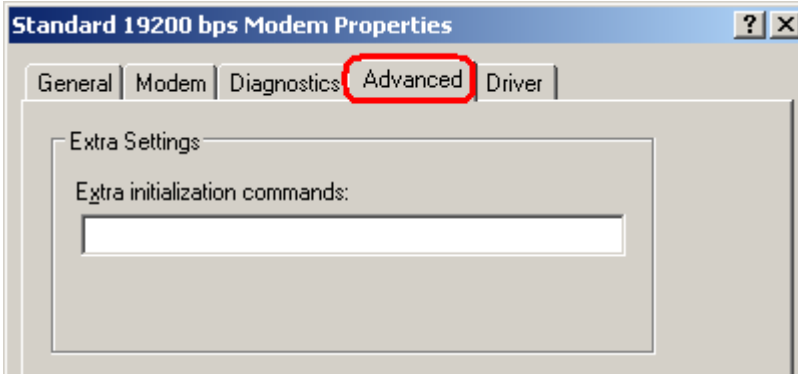

3. Enter the following commands in the **Extra initialization commands:** text box.

**AT+CGDCONT=1,"IP", "<APN>"**

Replace <APN> with the correct service for your account. For example:

**AT+CGDCONT=1,"IP", "cmnet"**

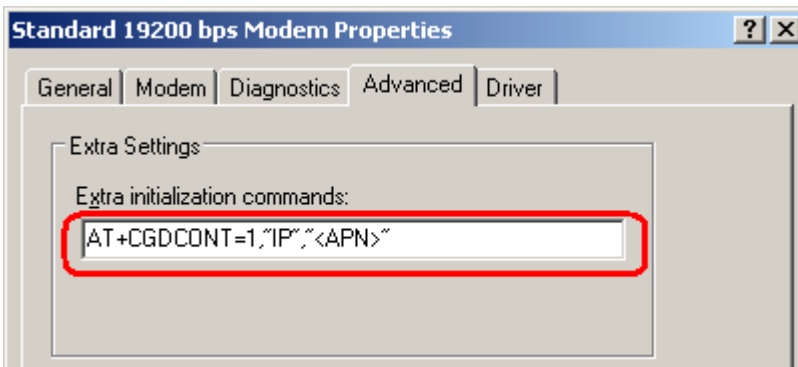

4. Click **OK** to close the **Properties** window.

### Modify Modem Baud Rate to 115200 bps under Normal Mode

1. In the Modem Configurator, Click the **Debug** tab, select 115200 bps, and then click **"Change Baudrate to"**.



### Modify Modem Driver Baud Rate to 115200 bps

1. From the Control Panel, open **Phone and Modem Options**, click the **Modem** tab, and then click **Properties**.

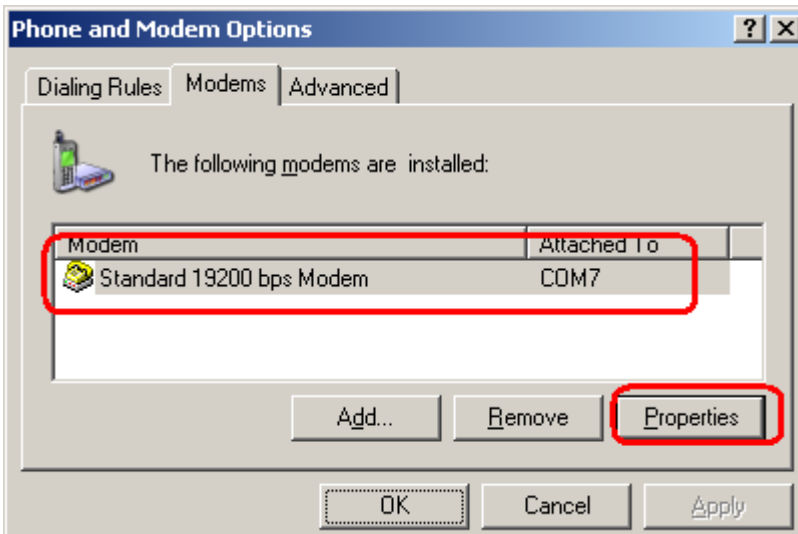



2. Click the **Modem** tab next, select 115200 at **Maximum Port Speed** then click OK.

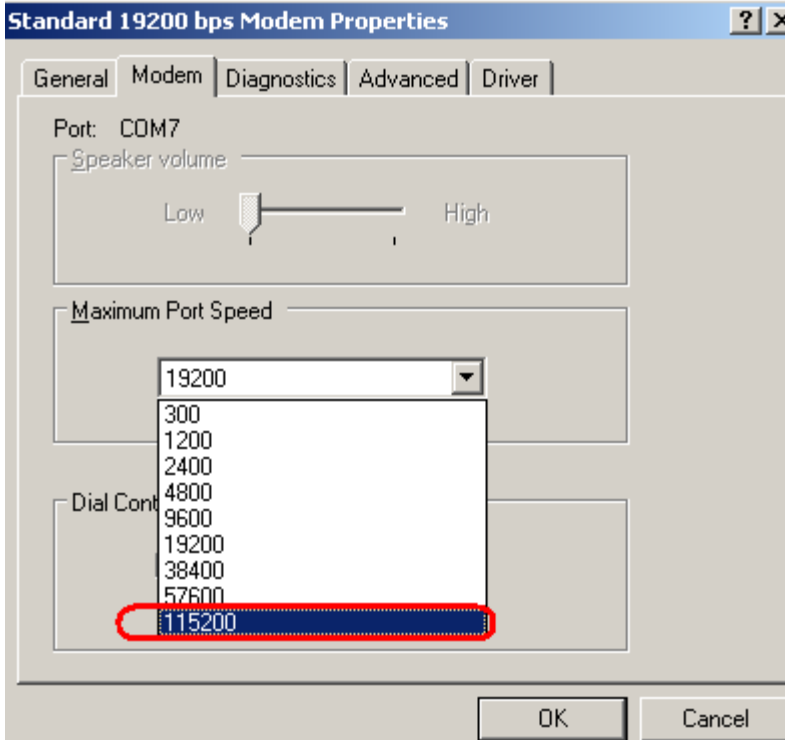

**Adding Windows DUN**

Follow these steps to add Windows Dial-up Networking.

1. In the Control Panel, open Network Connections, and then click **Create a new connection**.
2. When the **New Connection Wizard** window opens, select the **Connect to Internet** option, and then click **Next**.

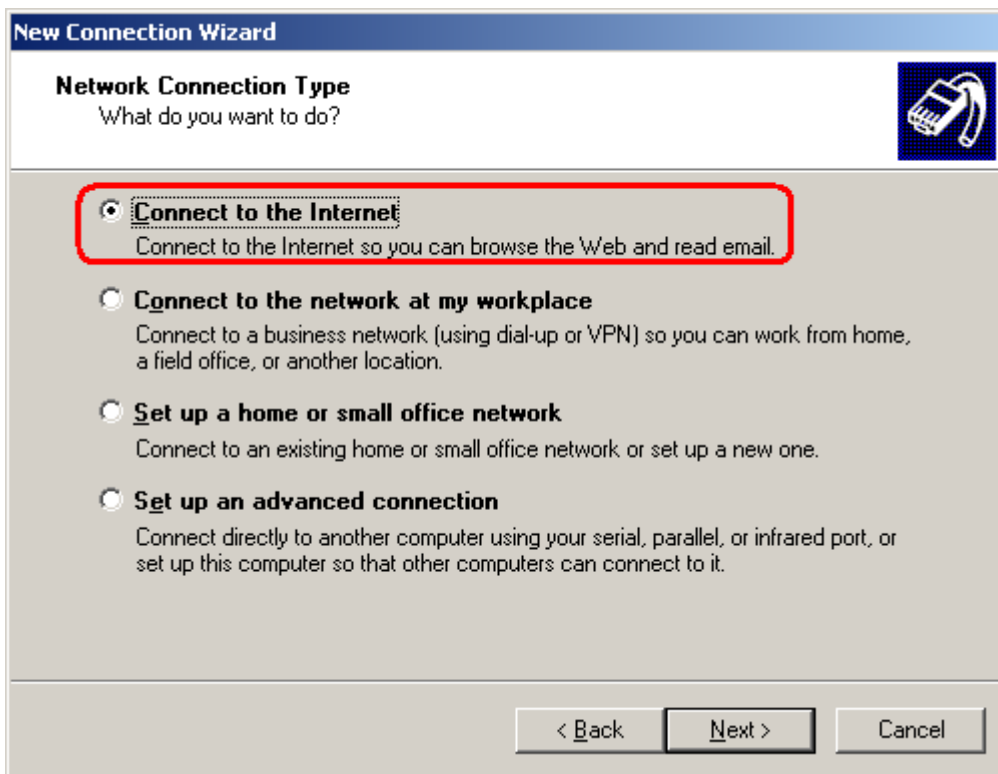

3. Select the **Set up my connection manually** option, and then click **Next**.

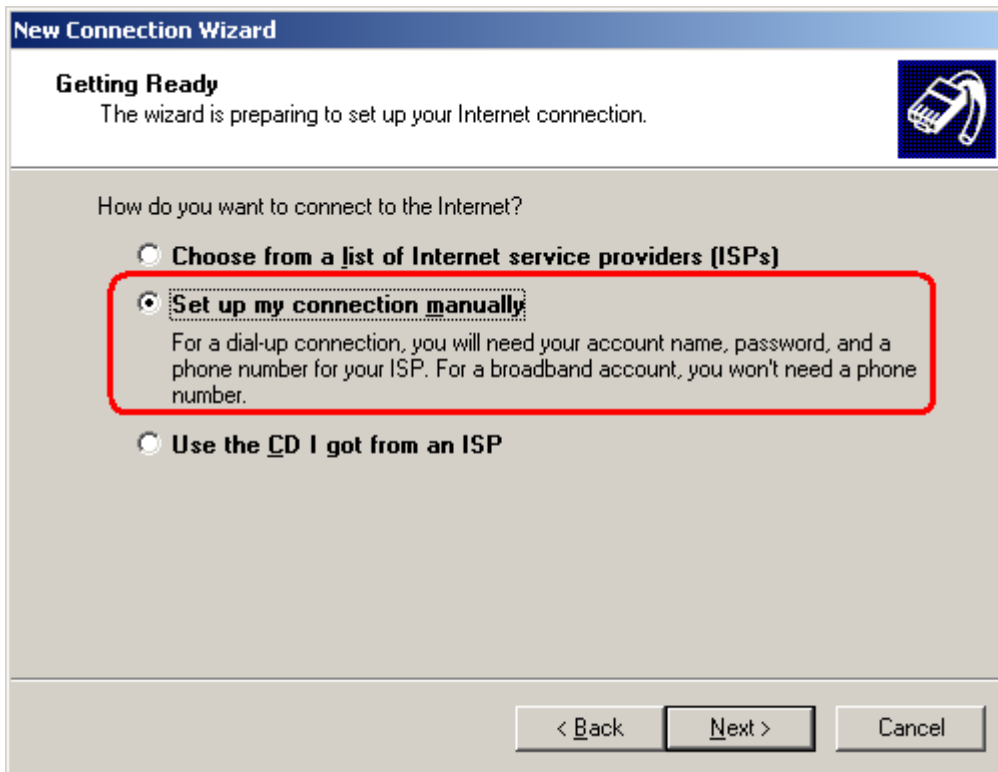

4. Select the **Connect using a dial-up modem** option, and then click **Next**.

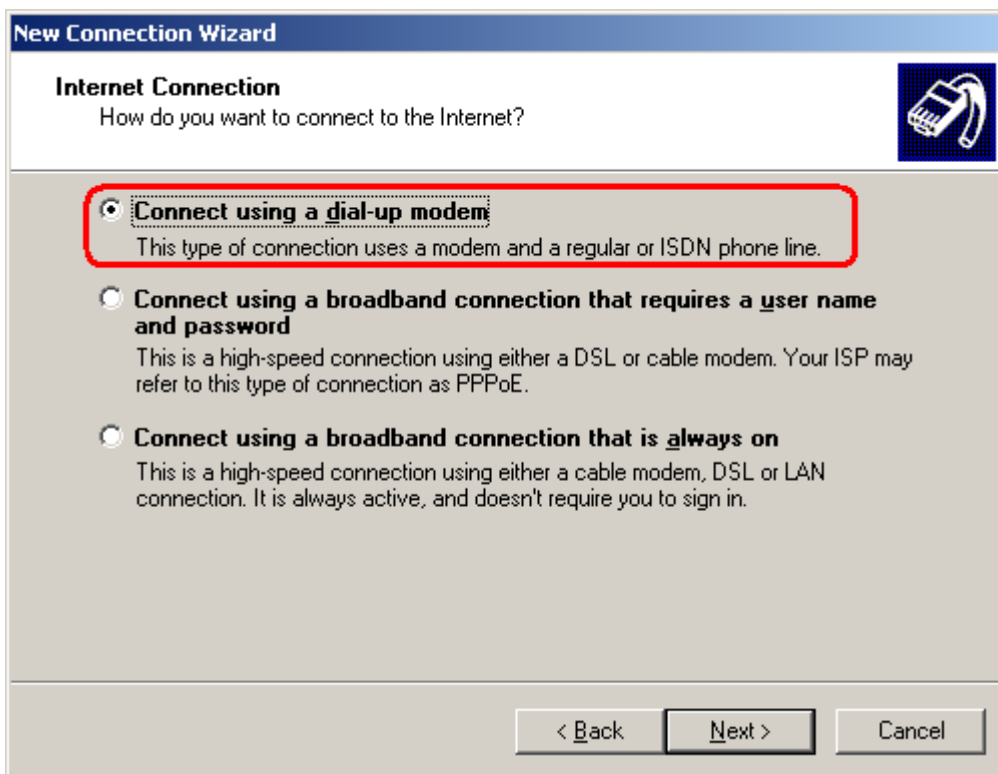

5. Type the name of your service provider in the text input box, and then click **Next**.

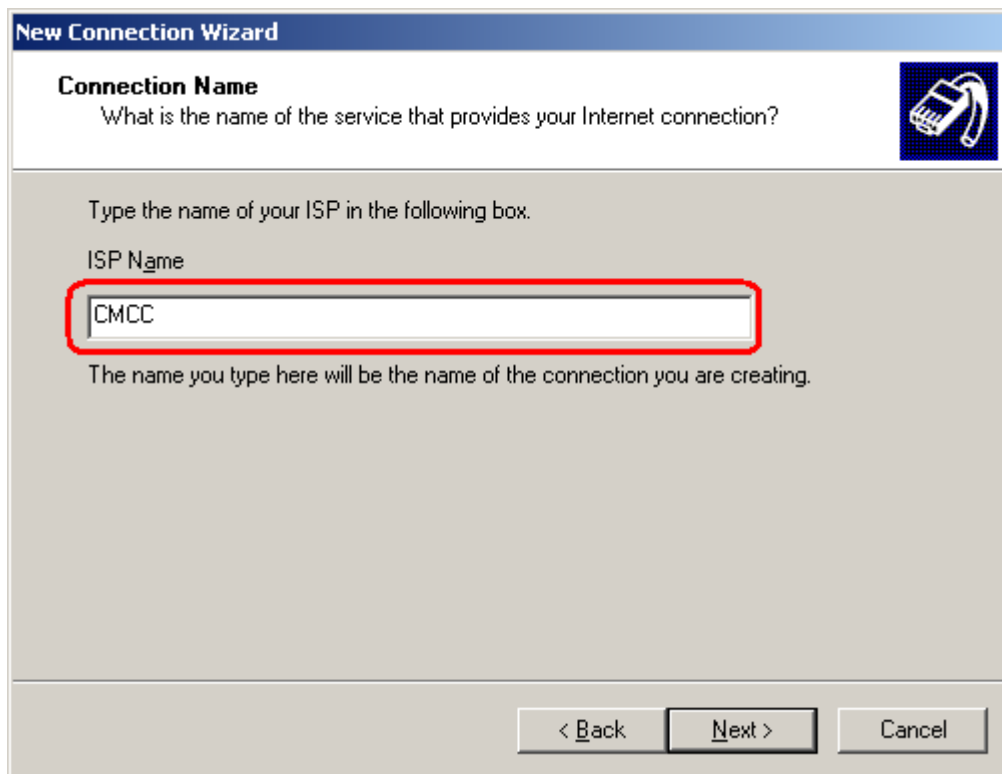

**New Connection Wizard**

**Connection Name**  
What is the name of the service that provides your Internet connection?

Type the name of your ISP in the following box.

ISP Name

CMCC

The name you type here will be the name of the connection you are creating.

< Back   Next >   Cancel

6. Type **\*99\*\*\*1#** in the Phone number text input box, and then click **Next**.

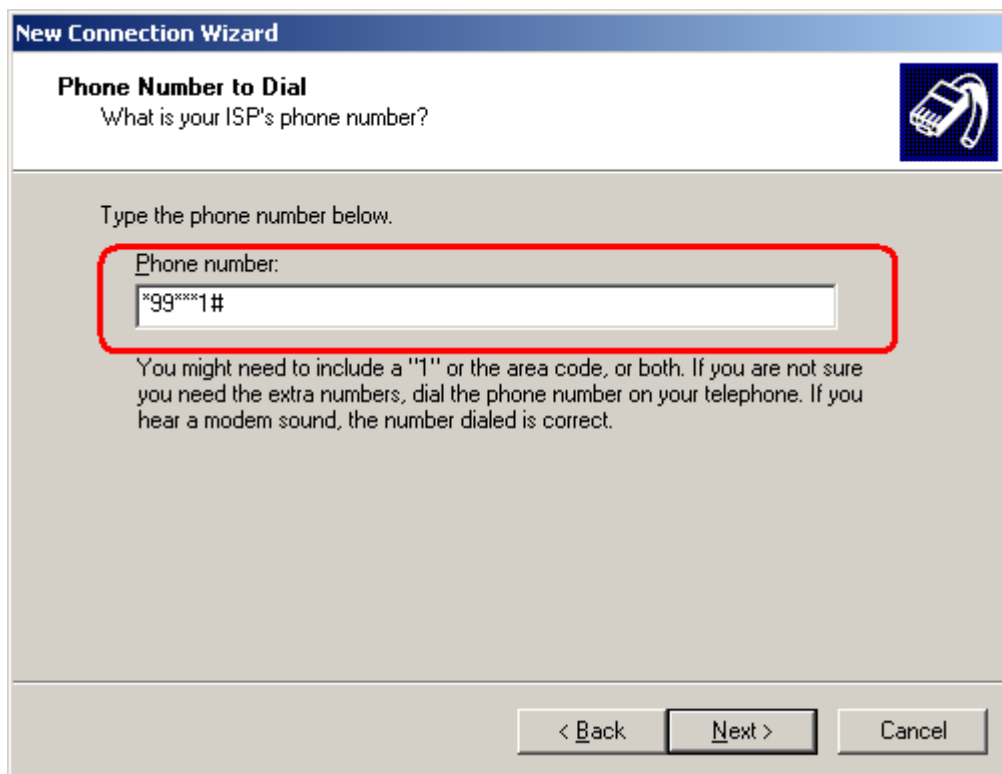

**New Connection Wizard**

**Phone Number to Dial**  
What is your ISP's phone number?

Type the phone number below.

Phone number:

\*99\*\*\*1#

You might need to include a "1" or the area code, or both. If you are not sure you need the extra numbers, dial the phone number on your telephone. If you hear a modem sound, the number dialed is correct.

< Back   Next >   Cancel

7. Type the **User name** and **Password** in the appropriate text boxes, and then click **Next**.

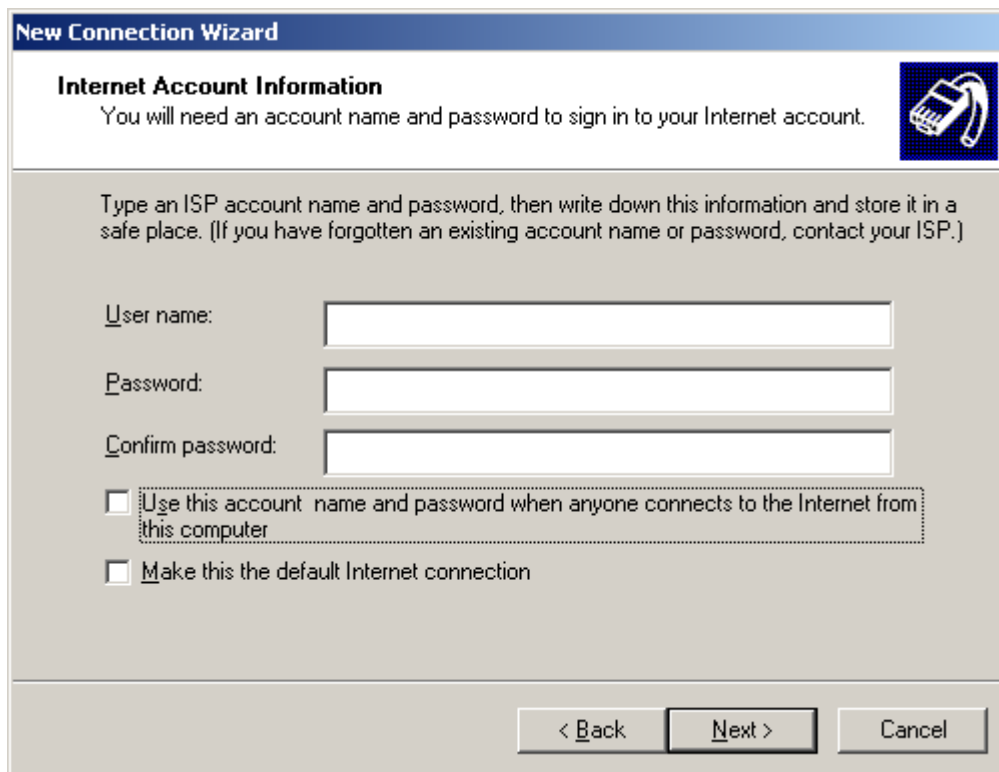

**New Connection Wizard**

**Internet Account Information**

You will need an account name and password to sign in to your Internet account.

Type an ISP account name and password, then write down this information and store it in a safe place. (If you have forgotten an existing account name or password, contact your ISP.)

User name:

Password:

Confirm password:

Use this account name and password when anyone connects to the Internet from this computer

Make this the default Internet connection

< Back   Next >   Cancel

8. Click **Finish**.



**New Connection Wizard**

**Completing the New Connection Wizard**

You have successfully completed the steps needed to create the following connection:

**CMCC**

- Share with all users of this computer

The connection will be saved in the Network Connections folder.

Add a shortcut to this connection to my desktop

To create the connection and close this wizard, click Finish.

< Back   Finish   Cancel

9. Click **Dial** to establish the connection.



## Chapter 5. Appendix

### 5.1 Factory Settings

Factory setting of the modem COM port under **Config Mode** is:

**Data bits = 8**

**Parity = none**

**Stop bits = 1**

**Baud = 115200 bps**

**Flow control = none**

Factory setting of the modem COM port under **Normal Mode** is: **Autobauding**

**The autobauding mode allows the modem to automatically detect the transmission speed used by the DTE.**

**Only the following speeds will be detected: 300, 600, 1200, 2400, 4800, 9600, 14400, 19200, 28800, 38400, 57600, 115200bps. Auto-baud detection cannot be guaranteed for speeds below or above these speeds.**

### 5.2 Restore to Factory Default

The modem could be restored to factory default by Modem Configurator, SMS and hardware operation.

Following steps indicate how to restore to factory default by hardware operation:

1. Set the modem under Normal Mode, power on the modem;
2. Within 3 seconds, change the modem from Normal Mode to Config Mode;
3. Within 3 seconds, change the modem from Config Mode to Normal Mode again;
4. Within 3 seconds, change the modem from Normal Mode to Config Mode again;
5. Restore successfully.

**Note:** *PIN setting, Phone Book settings and COM settings will not be restored to factory default.*

### 5.3 SMS Commands for Remote Control

#### 5.3.1 SMS Commands Structure

M1000 supports remote configuration and remote modem status reading via SMS. An SMS command has following structure: **Password:cmd1,a,b,c;cmd2,d,e,f;cmd3,g,h,i;...;cmdn,j,k,n**

- Password: SMS control password is configured at **Basic->SMS Control->Password**, which is an optional parameter.

When there is no password, SMS command has following structure: **cmd1;cmd2;cmd3;...;cmdn**

When there is a password, SMS command has following structure: **Password:cmd1;cmd2;cmd3;...;cmdn**

- Cmd1, cmd2, cmd3 to Cmdn, which are command identification number 0000 – 9999
- A, b, c to n, which are command parameters
- The semicolon character (“;”) is used to separate more than one commands packed in a single SMS.

### 5.3.2 SMS Control Steps

1. Use command **Password:cmd1;cmd2;cmd3;...;cmdn or cmd1;cmd2;cmd3;...;cmdn** to set new parameters.
2. After setting new parameters for M1000, remember to use **0004** command to save parameters and reset the modem, then the new parameters will take effect.
3. In one SMS, if there is more than two cmd, remember to use punctuation “;” to divide each cmd.

**Note:** E.g., 1234:1001,M1000;0004

In this command, password is 1234, 1001 is the cmd to set device’s name, “M1000” is M1000’s name that we want to set, then save parameters and reset the modem to take effect with command 0004.

### 5.3.3 SMS Commands List

Cmd	Description	Syntax	Comments
<b>Control Commands</b>			
0000	Set Factory Defaults	password:cmd or cmd	if no password, please use command "cmd", or use command "password:cmd" if there is a password. Following commands are the same.
0001	Reset Device	cmd	
0002	Save Parameters	cmd	
0003	Get Device Status	cmd	
0004	Save Parameters and Reset Device	cmd	
0005	Clear SMS Count	cmd	
0006	Clear Event Count	cmd	
0007	Start Event Counter	cmd	
<b>Set Commands</b>			
1000	Set Comm Parameters	cmd,baud rate,parity,data bits,stop bits,flag	baud rate: 1200 - 115200 parity: n,o,e,m,s data bits: 7,8 stop bits: 1,2 *flag: 0 - RS232 1 - RS485
1001	Set Device Name	cmd,name	name(max 20 bytes)
1002	Set SIM Card Pin	cmd,flag1,pin,flag2,newPin	flag1:

			0 - disable pin lock 1 - enable pin lock pin(4 - 8 bytes) flag2: 0 - disable change pin 1 - enable change pin *newPin(4 - 8 bytes and can be null)
1003	Set SMS Control Passwd	cmd,passwd	*passwd(max 20 bytes and can be null)
1004	Enable Auto CSD	cmd,flag	flag: 0 - disable 1 - enable
1005	Enable Auto Delete SMS	cmd,flag	flag: 0 - disable 1 - enable
1006	Set SMS in	cmd,flag1,format,flag2	flag1: 0 - disable SMS in 1 - enable SMS in format: 0 - text ASCII 1 - Unicode(UCS2) 2 - Binary(8 bits) flag2:(only available in format "text ASCII") 0 - from mobile 1 - not from mobile
1007	Set SMS out	cmd,flag1,format,flag2	flag1: 0 - disable SMS out 1 - enable SMS out format: 0 - text ASCII 1 - Unicode(UCS2) 2 - Binary(8 bits) flag2:(only available in format "text ASCII") 0 - to mobile 1 - not to mobile
1008	Enable Auto Add Timestamp	cmd,flag	flag: 0 - disable 1 - enable
1009	Set Max SMS Day Sent	cmd,value	value: 0 - 10000
1010	Set Data Packing Interval Timeout	cmd,timeout	timeout: (2 - 100)* 100ms
1011	Set Packet Length	cmd,length	length: 0 - 1024



1012	Set Packet Delimiter 1	cmd,flag,delimiter	flag: 0 - disable 1 - enable delimiter: 00 - ff (hex format)
1013	Set Packet Delimiter 2	cmd,flag,delimiter	flag: 0 - disable 1 - enable delimiter: 00 - ff (hex format)
1014	Set Packet Delimiter Process	cmd,process	process: 0 - do nothing 1 - delimiter +1 2 - delimiter +2 3 - strip delimiter
1015	Set Auto SMS	cmd,flag,time,content	flag: 0 - disable 1 - enable time: 00:00 - 23:59 content: max 30 bytes
1016	Set Time Reboot	cmd,flag,time1,time2,time3	flag: 0 - disable time reboot 1 - enable time reboot time1: 00:00 - 23:59 *time2: 00:00 - 23:59 (can be null) *time3: 00:00 - 23:59 (can be null)
1017	Set Call Reboot	cmd,flag1,flag2,content	flag1: 0 - disable call wakeup 1 - enable call wakeup flag2: 0 - disable sms reply 1 - enable sms reply content(max 20 bytes)
1018	Set SMS Reboot	cmd,flag1,flag2,passwd,content	flag1: 0 - disable sms wakeup 1 - enable sms wakeup flag2:(can be null) 0 - disable sms reply 1 - enable sms reply *passwd(max 20 bytes and can be null) *content(max 20 bytes and can be null)
1019	Set Ignition	cmd,flag1,flag2,value	flag1: 0 - disable DTR wakeup 1 - enable DTR wakeup flag2:

			<p>0 - don't ignore AT^SMSO  1 - ignoreAT^SMSO  value: 0 - 60s (power on delay turn on module)</p>
1020	Set Singal Update Frequency	cmd,value	value: 5 - 1200s
1021	Set Init String	cmd,index,content	<p>index: 0 - 3(0 - M1000 will auto generate a index when the init string array isn't full)  content: max 40 bytes</p>
1022	Set Phone Number	cmd,index,number,flag	<p>index: 0 - 10(0 - M1000 will auto generate a index when the phone book isn't full)  number(max 20 bytes)  flag: xxxxx (binary format: 00000 - 11111)  flag.0:  0 - disable call reboot  1 - enable call reboot  flag.1:  0 - disable sms reboot  1 - enable sms reboot  flag.2:  0 - disable sms in  1 - enable sms in  flag.3:  0 - disable sms out  1 - enable sms out  flag.4:  0 - disable sms control  1 - enable sms control</p>
1023	Set Phone Group	cmd,index,flag	<p>index: 1 - 10(phone group index)  flag: xxxxxxxxxx (binary format: 0000000000 - 1111111111)  flag.0 ~ flag.9: (phone number index)  0 - exclude in this phone group  1 - include in this phone group</p>
1024	Set Modbus Parameters	cmd,flag1,id,address1,address2,flag2,address3,address4,address5,address6,address7	<p>flag1:  0 - enable modbus  1 - disable modbus  *id - slave address  *address1 - coil address  *address2 - register address  *flag2:  0 - enable PLC send SMS  1 - disable PLC send SMS</p>

			<p>*address3 - write phone number address</p> <p>*address4 - SMS content address</p> <p>*address5 - read phone number address</p> <p>*address6 - SMS received date address</p> <p>*address7 - SMS received content address</p>
1025	Set Coil Parameters	cmd,index,content1,content2,group	<p>index: 1 - 8</p> <p>*content1: on message (max 70 bytes)</p> <p>*content2: off message (max 70 bytes)</p> <p>group: 1 - 10 (phone group)</p>
1026	Set Register Parameters	cmd,index,name,max,min,group	<p>index: 1 - 15</p> <p>*name: register's name</p> <p>max: max value (0 - 65535)</p> <p>min: min value (0 - 65535)</p> <p>group: 1 - 10 (phone group)</p>
1027	Set DI Parameters	cmd,mode,filtering,trigger,active,flag,message1,message2,group	<p>mode:</p> <p>1 - OFF</p> <p>2 - ON</p> <p>3 - ONChange</p> <p>4 - Event Counter</p> <p>5 - Null</p> <p>filtering: (0 - 10000)</p> <p>*trigger: (0 - 30000)</p> <p>*active:</p> <p>0 - Lo to Hi</p> <p>1 - Hi to Lo</p> <p>*flag</p> <p>0 - disable counter start when power on</p> <p>1 - enable counter start when power on</p> <p>*message1: alarm on message (max 70 bytes)</p> <p>*message2: alarm off message (max 70 bytes)</p> <p>*group: 1 - 10 (phone group)</p>
1028	Set DO Parameters	cmd,flag,onAction,offAction,flag1,keepOn	<p>flag: xxxx (binary format: 000 - 111)</p> <p>flag.0 :</p> <p>0 - disable DI alarm control DO output</p> <p>1 - enable DI alarm control DO output</p> <p>flag.1:</p> <p>0 - disable SMS control DO output</p> <p>1 - enable SMS control DO output</p> <p>flag.2 :</p>

			<p>0 - disable phone control DO output                  1 - enable phone control DO output                  onAction: alarm on action                  1 - OFF                  2 - ON                  3 - Pulse                  4 - Null                  offAction : alarm off action                  1 - OFF                  2 - ON                  3 - Pulse                  4 - Null                  flag1:                  0 - DO open when power on                  1 - DO close when power on                  *keepOn: how many times the DO keeps close (0 - 255)</p>
1029	Set Pulse Parameters	cmd,low,high,output,delay	<p>low: 1 - 30000                  high: 1 - 30000                  output: 0 - 30000                  delay: 0 - 30000</p>
1030	Set DO SMS Control Parameters	cmd,onContent,offContent,group	<p>*onContent: max 70 bytes                  *offContent: max 70 bytes                  group: 1 - 10 (phone group)</p>
<b>Get Commands</b>			
2000	Get Base Parameters	cmd	<p>return:                  1 - comm                  2 - comm type                  3 - device name                  4 - ME Type                  5 - IMEI                  6 - auto CSD                  7 - auto delete SMS                  8 - sms control passwd                  9 - SIM card pin setup</p>
2001	Get SMS Direct Parameters	cmd	<p>return:                  1 - sms in                  2 - sms out                  3 - auto add timestamp                  4 - max SMS day sent</p>
2002	Get Data Packing Parameters	cmd	<p>return:                  1 - data packing interval timeout                  2 - packet length</p>

			3 - delimiter1 and enable 4 - delimiter and enable 5 - delimiter process 6 - Tx delay 7 - enable online sms notification 8 - internal roaming
2003	Get Reboot Parameters	cmd	return: 1 - time reboot 2 - call reboot 3 - sms reboot 4 - ignition
2004	Get Init Strimg Parameters	cmd	return: 1 - index 2 - AT content
2005	Get Phone Number Parameters	cmd	return: index,number,call reboot,call wakeup,sms reboot,sms wakeup,sms control
2006	Get Firmware Version	cmd	return: firmware version
2007	Get Phone Group Parameters	cmd	return: index: phone group index flag: xxxxxxxxxx (binary format: 0000000000 - 1111111111) flag.0 ~ flag.9: (phone number index) 0 - exclude in this phone group 1 - include in this phone group
2008	Get Modbus Parameters	cmd	return: modbus parameters
2009	Get Coil Parameters	cmd	return: coil parameters
2010	Get Register Parameters	cmd	return: register parameters
2011	Get DI Parameters	cmd	return: DI parameters
2012	Get DO Parameters	cmd	return: DO parameters

**Note:**

1. All the phone number stored in Phone Book has the right to control the modem via SMS.
2. PIN setting, Phone Book settings and COM settings will not be restored to factory default.

### 5.3.4 SMS Control Examples

Assume that there is no SMS control password configured at Basic->SMS Control->Password. Here is the SMS control examples:

1. Set Comm Parameters
  - If you do not modify serial type, serial port parameters are 9600-none-8-1, corresponding command is: **1000,9600,n,8,1**
  - If want to set serial port type as RS485, serial port parameters are 9600-none-8-1, corresponding command is: **1000,9600,n,8,1,1**
2. Set M1000's name
  - If you want to set M1000 name as "M1000", corresponding command is : 1001,M1000;0004

## 5.4 Modbus Address Mapping

### DI and DO:

Address	Description	Value
<b>0x3000 Read/Write Coils</b>		
0x3000	DI_0 Status	1: On 0: Off
0x3001	DI_1 Status	1: On 0: Off
0x3002	DO_0 Status	1: On 0: Off
0x3003	DI_0 Clear Count Value	1: Clear Counter Value 0: Return Illegal Data Value
0x3005	DI_0 Start Event Counter	1: Start Event Conuter 0: Return Illegal Data Value
<b>0x4000 Read/Write Registers</b>		
0x4000	DI_0 Count Value	

## 5.5 GSM Alphabet

Standard SMS can contain 160 characters. However, the characters typed must be part of the so-called 7-bit default alphabet as specified by GSM 3.38. You can see in the table below that this alphabet contains all ASCII characters and some accented characters.

For example, u umlaut (ü) and e with grave (è), are in this set. Please study the table below to have a complete overview. Using any character not in this set, will make the SMS a Unicode SMS and limit the length of the SMS to 70 characters.

Note: a few characters actually count as two characters. These characters are:

{ } [ ] ~ | \ and the Euro symbol: €

You can also see that in the table below in the hex column. These characters need to be escaped.

Below is the 7 bit default alphabet as specified by GSM 03.38. The corresponding ISO-8859-1 decimal codes are shown in the rightmost column. Note that the euro sign (€) is also included.

Hex	Dec	Character name	Character	ISO-8859-1 DEC
0x00	0	COMMERCIAL AT	@	64
0x01	1	POUND SIGN	£	163
0x02	2	DOLLAR SIGN	\$	36

0x03	3	YEN SIGN	¥	165
0x04	4	LATIN SMALL LETTER E WITH GRAVE	è	232
0x05	5	LATIN SMALL LETTER E WITH ACUTE	é	233
0x06	6	LATIN SMALL LETTER U WITH GRAVE	ù	249
0x07	7	LATIN SMALL LETTER I WITH GRAVE	ì	236
0x08	8	LATIN SMALL LETTER O WITH GRAVE	ò	242
0x09	9	LATIN CAPITAL LETTER C WITH CEDILLA	Ç	199
0x0A	10	LINE FEED		10
0x0B	11	LATIN CAPITAL LETTER O WITH STROKE	Ø	216
0x0C	12	LATIN SMALL LETTER O WITH STROKE	ø	248
0x0D	13	CARRIAGE RETURN		13
0x0E	14	LATIN CAPITAL LETTER A WITH RING ABOVE	Å	197
0x0F	15	LATIN SMALL LETTER A WITH RING ABOVE	å	229
0x10	16	GREEK CAPITAL LETTER DELTA	Δ	
0x11	17	LOW LINE	—	95
0x12	18	GREEK CAPITAL LETTER PHI	Φ	
0x13	19	GREEK CAPITAL LETTER GAMMA	Γ	
0x14	20	GREEK CAPITAL LETTER LAMBDA	Λ	
0x15	21	GREEK CAPITAL LETTER OMEGA	Ω	
0x16	22	GREEK CAPITAL LETTER PI	Π	
0x17	23	GREEK CAPITAL LETTER PSI	Ψ	
0x18	24	GREEK CAPITAL LETTER SIGMA	Σ	
0x19	25	GREEK CAPITAL LETTER THETA	Θ	
0x1A	26	GREEK CAPITAL LETTER XI	Ξ	
0x1B	27	ESCAPE TO EXTENSION TABLE		
0x1B0A	27 10	FORM FEED		12
0x1B14	27 20	CIRCUMFLEX ACCENT	^	94
0x1B28	27 40	LEFT CURLY BRACKET	{	123
0x1B29	27 41	RIGHT CURLY BRACKET	}	125
0x1B2F	27 47	REVERSE SOLIDUS (BACKSLASH)	\	92
0x1B3C	27 60	LEFT SQUARE BRACKET	[	91
0x1B3D	27 61	TILDE	~	126
0x1B3E	27 62	RIGHT SQUARE BRACKET	]	93
0x1B40	27 64	VERTICAL BAR		124
0x1B65	27 101	EURO SIGN	€	164 (ISO-8859-15)
0x1C	28	LATIN CAPITAL LETTER AE	Æ	198
0x1D	29	LATIN SMALL LETTER AE	æ	230
0x1E	30	LATIN SMALL LETTER SHARP S (German)	ß	223
0x1F	31	LATIN CAPITAL LETTER E WITH ACUTE	É	201
0x20	32	SPACE		32
0x21	33	EXCLAMATION MARK	!	33
0x22	34	QUOTATION MARK	“	34

0x23	35	NUMBER SIGN	#	35
0x24	36	CURRENCY SIGN	¤	164 (ISO-8859-1)
0x25	37	PERCENT SIGN	%	37
0x26	38	AMPERSAND	&	38
0x27	39	APOSTROPHE	'	39
0x28	40	LEFT PARENTHESIS	(	40
0x29	41	RIGHT PARENTHESIS	)	41
0x2A	42	ASTERISK	*	42
0x2B	43	PLUS SIGN	+	43
0x2C	44	COMMA	,	44
0x2D	45	HYPHEN-MINUS	-	45
0x2E	46	FULL STOP	.	46
0x2F	47	SOLIDUS (SLASH)	/	47
0x30	48	DIGIT ZERO	0	48
0x31	49	DIGIT ONE	1	49
0x32	50	DIGIT TWO	2	50
0x33	51	DIGIT THREE	3	51
0x34	52	DIGIT FOUR	4	52
0x35	53	DIGIT FIVE	5	53
0x36	54	DIGIT SIX	6	54
0x37	55	DIGIT SEVEN	7	55
0x38	56	DIGIT EIGHT	8	56
0x39	57	DIGIT NINE	9	57
0x3A	58	COLON	:	58
0x3B	59	SEMICOLON	;	59
0x3C	60	LESS-THAN SIGN	<	60
0x3D	61	EQUALS SIGN	=	61
0x3E	62	GREATER-THAN SIGN	>	62
0x3F	63	QUESTION MARK	?	63
0x40	64	INVERTED EXCLAMATION MARK	¡	161
0x41	65	LATIN CAPITAL LETTER A	A	65
0x42	66	LATIN CAPITAL LETTER B	B	66
0x43	67	LATIN CAPITAL LETTER C	C	67
0x44	68	LATIN CAPITAL LETTER D	D	68
0x45	69	LATIN CAPITAL LETTER E	E	69
0x46	70	LATIN CAPITAL LETTER F	F	70
0x47	71	LATIN CAPITAL LETTER G	G	71
0x48	72	LATIN CAPITAL LETTER H	H	72
0x49	73	LATIN CAPITAL LETTER I	I	73
0x4A	74	LATIN CAPITAL LETTER J	J	74
0x4B	75	LATIN CAPITAL LETTER K	K	75
0x4C	76	LATIN CAPITAL LETTER L	L	76



0x4D	77	LATIN CAPITAL LETTER M	M	77
0x4E	78	LATIN CAPITAL LETTER N	N	78
0x4F	79	LATIN CAPITAL LETTER O	O	79
0x50	80	LATIN CAPITAL LETTER P	P	80
0x51	81	LATIN CAPITAL LETTER Q	Q	81
0x52	82	LATIN CAPITAL LETTER R	R	82
0x53	83	LATIN CAPITAL LETTER S	S	83
0x54	84	LATIN CAPITAL LETTER T	T	84
0x55	85	LATIN CAPITAL LETTER U	U	85
0x56	86	LATIN CAPITAL LETTER V	V	86
0x57	87	LATIN CAPITAL LETTER W	W	87
0x58	88	LATIN CAPITAL LETTER X	X	88
0x59	89	LATIN CAPITAL LETTER Y	Y	89
0x5A	90	LATIN CAPITAL LETTER Z	Z	90
0x5B	91	LATIN CAPITAL LETTER A WITH DIAERESIS	Ä	196
0x5C	92	LATIN CAPITAL LETTER O WITH DIAERESIS	Ö	214
0x5D	93	LATIN CAPITAL LETTER N WITH TILDE	Ñ	209
0x5E	94	LATIN CAPITAL LETTER U WITH DIAERESIS	Ü	220
0x5F	95	SECTION SIGN	§	167
0x60	96	INVERTED QUESTION MARK	¿	191
0x61	97	LATIN SMALL LETTER A	a	97
0x62	98	LATIN SMALL LETTER B	b	98
0x63	99	LATIN SMALL LETTER C	c	99
0x64	100	LATIN SMALL LETTER D	d	100
0x65	101	LATIN SMALL LETTER E	e	101
0x66	102	LATIN SMALL LETTER F	f	102
0x67	103	LATIN SMALL LETTER G	g	103
0x68	104	LATIN SMALL LETTER H	h	104
0x69	105	LATIN SMALL LETTER I	i	105
0x6A	106	LATIN SMALL LETTER J	j	106
0x6B	107	LATIN SMALL LETTER K	k	107
0x6C	108	LATIN SMALL LETTER L	l	108
0x6D	109	LATIN SMALL LETTER M	m	109
0x6E	110	LATIN SMALL LETTER N	n	110
0x6F	111	LATIN SMALL LETTER O	o	111
0x70	112	LATIN SMALL LETTER P	p	112
0x71	113	LATIN SMALL LETTER Q	q	113
0x72	114	LATIN SMALL LETTER R	r	114
0x73	115	LATIN SMALL LETTER S	s	115
0x74	116	LATIN SMALL LETTER T	t	116
0x75	117	LATIN SMALL LETTER U	u	117
0x76	118	LATIN SMALL LETTER V	v	118

0x77	119	LATIN SMALL LETTER W	w	119
0x78	120	LATIN SMALL LETTER X	x	120
0x79	121	LATIN SMALL LETTER Y	y	121
0x7A	122	LATIN SMALL LETTER Z	z	122
0x7B	123	LATIN SMALL LETTER A WITH DIAERESIS	ä	228
0x7C	124	LATIN SMALL LETTER O WITH DIAERESIS	ö	246
0x7D	125	LATIN SMALL LETTER N WITH TILDE	ñ	241
0x7E	126	LATIN SMALL LETTER U WITH DIAERESIS	ü	252
0x7F	127	LATIN SMALL LETTER A WITH GRAVE	à	224

## 5.6 Troubleshooting

This section of the document describes possible problems encountered when using the Robustel M1000 modem and their solutions.

### 5.5.1 The modem's LED does not light:

- Check if modem has connected to a 9 to 36VDC power supply properly.
- Check if the power connector is properly inserted.

### 5.5.2 M1000 keep rebooting all the time:

Please make sure you have inserted the SIM card.

### 5.5.3 No connection with modem through serial link

- Check if the serial cable has been connected properly.
- Check if the serial cable has been made by following pin assignment given in table [PIN Assignment](#) for RS232 and RS485.
- Check if your program has proper setting. Factory setting of the modem under **Normal Mode** is listed at [5.1](#).
- Check if there is another program interfering with the communication program, such as conflict on communication port access.

## 5.5.4 Receiving “No Carrier” Message

If the modem returns a “No Carrier” message upon an attempted call (voice or data), then refer to the table below for possible causes and solutions.

If the modem returns...	Then ask...	Action...
“No Carrier”	Is the received signal strong enough?	Refer to section <a href="#">5.2.7 Networks</a> -> Values of received signal strength (RSSI)
	Is the modem registered on the network?	Refer to section <a href="#">5.2.7 Networks</a> -> Registration
	Is the antenna properly connected?	Refer to section <a href="#">2.5 Connect the External Antenna (SMA Type)</a> .
“No Carrier” (when trying to issue a voice communication)	Is the semicolon (;) entered immediately after the phone number in the AT command?	Ensure that the semicolon (;) is entered immediately after the phone number in the AT command. e.g. ATD123456;
“No Carrier” (when trying to issue a data communication)	Is the SIM card configured for data / fax calls?	Configure the SIM card for data / fax calls (Ask your network provider if necessary).
	Is the selected bearer type supported by the called party?	Ensure that the selected bearer type is supported by the called party.
	Is the selected bearer type supported by the network?	Ensure that the selected bearer type is supported by the network. If no success, try bearer select type by AT command: AT+CBST=0,0,3

## 5.7 Terms and Abbreviations

Abbreviations	Description
AC	Alternating Current
APN	Access Point Name of GPRS Service Provider Network
CE	Conformité Européene (European Conformity)
CHAP	Challenge Handshake Authentication Protocol
CSD	Circuit Switched Data
CTS	Clear to Send
dB	Decibel
dBi	Decibel Relative to an Isotropic radiator
DC	Direct Current
DCD	Data Carrier Detect
DCE	Data Communication Equipment (typically modems)
DCS 1800	Digital Cellular System, also referred to as PCN
DI	Digital Input

DO	Digital Output
DSR	Data Set Ready
DTE	Data Terminal Equipment
DTMF	Dual Tone Multi-frequency
DTR	Data Terminal Ready
EMC	Electromagnetic Compatibility
EMI	Electromagnetic Interference
ESD	Electrostatic Discharges
ETSI	European Telecommunications Standards Institute
GND	Ground
GPRS	General Package Radio Service
GSM	Global Standard for Mobile Communications
IMEI	International Mobile Equipment Identification
kbps	kbits per second
LED	Light Emitting Diode
MAX	Maximum
Min	Minimum
MO	Mobile Originated
MS	Mobile Station
MT	Mobile Terminated
PAP	Password Authentication Protocol
PC	Personal Computer
PCN	Personal Communications Network, also referred to as DCS 1800
PCS	Personal Communication System, also referred to as GSM 1900
PDU	Protocol Data Unit
PPP	Point-to-point Protocol
PIN	Personal Identity Number
PSU	Power Supply Unit
PUK	Personal Unblocking Key
R&TTE	Radio and Telecommunication Terminal Equipment
RF	Radio Frequency
RTC	Real Time Clock
RTS	Request to Send
Rx	Receive Direction
SIM	Subscriber Identification Module
SMA	Subminiature Version A RF Connector
SMS	Short Message Service
TCP/IP	Transmission Control Protocol / Internet Protocol
TE	Terminal Equipment, also referred to as DTE
Tx	Transmit Direction
UART	Universal Asynchronous Receiver-transmitter
USSD	Unstructured Supplementary Service Data

VSWR	Voltage Stationary Wave Ratio
------	-------------------------------