

Robustel GoRugged M1000 UP

Industrial Cellular USB Modem

for 2G / 3G / 4G Networks

User Guide

Document Name:	User Guide
Date:	2014-01-17
Status:	Confidential
DocID:	RT_UG_M1000 UP_v.1.0.0



Robustel

www.robustel.com

About This Document

This document describes the hardware and software of the *Robustel GoRugged M1000 UP*.

**Copyright© Guangzhou Robustel Technologies Co., Limited
All Rights Reserved.**

Trademarks and Permissions

Robustel are trademark of Guangzhou Robustel Technologies Co. Limited.

All other trademarks and trade names mentioned in this document are the property of their respective holders.

Disclaimer

No part of this document may be reproduced in any form without the written permission of the copyright owner. The contents of this document are subject to revision without notice due to continued progress in methodology, design and manufacturing. Robustel shall have no liability for any error or damage of any kind resulting from the use of this document.

Technical Support Contact Information

Tel: +86-18924045664
Fax: +86-20-82321505
E-mail: support@robustel.com
Web: www.robustel.com

Important Notice

Due to the nature of wireless communications, transmission and reception of data can never be guaranteed. Data may be delayed, corrupted (i.e., have errors) or be totally lost. Although significant delays or losses of data are rare when wireless devices such as the modem are used in a normal manner with a well-constructed network, the modem should not be used in situations where failure to transmit or receive data could result in damage of any kind to the user or any other party, including but not limited to personal injury, death, or loss of property. Robustel accepts no responsibility for damages of any kind resulting from delays or errors in data transmitted or received using the modem, or for failure of the modem to transmit or receive such data.

Safety Precautions

General

- The modem generates radio frequency (RF) power. When using the modem care must be taken on safety issues related to RF interference as well as regulations of RF equipment.
- Do not use your modem in aircraft, hospitals, petrol stations or in places where using CELLULAR products is prohibited.
- Be sure that the modem will not be interfering with nearby equipment. For example: pacemakers or medical equipment. The antenna of the modem should be away from computers, office equipment, home appliance, etc.
- An external antenna must be connected to the modem for proper operation. Only uses approved antenna with the modem. Please contact authorized distributor on finding an approved antenna.
- Always keep the antenna with minimum safety distance of 26.6 cm or more from human body. Do not put the antenna inside metallic box, containers, etc.

Note: *Some airlines may permit the use of cellular phones while the aircraft is on the ground and the door is open. Modem may be used at this time.*

Using the modem in vehicle

- Check for any regulation or law authorizing the use of CELLULAR in vehicle in your country before installing the modem.
- The driver or operator of any vehicle should not operate the modem while in control of a vehicle.
- Install the modem by qualified personnel. Consult your vehicle distributor for any possible interference of electronic parts by the modem.
- The modem should be connected to the vehicle's supply system by using a fuse-protected terminal in the vehicle's fuse box.
- Be careful when the modem is powered by the vehicle's main battery. The battery may be drained after extended period.

Protecting your modem

- To ensure error-free usage, please install and operate your modem with care. Do remember the follow:
- Do not expose the modem to extreme conditions such as high humidity/rain, high temperatures, direct sunlight, caustic / harsh chemicals, dust, or water.
- Do not try to disassemble or modify the modem. There is no user serviceable part inside and the warranty would be void.

- Do not drop, hit or shake the modem. Do not use the modem under extreme vibrating conditions.
- Do not pull the antenna or power supply cable. Attach/detach by holding the connector.
- Connect the modem only according to the instruction manual. Failure to do it will void the warranty.
- In case of problem, please contact authorized distributor.

Regulatory and Type Approval Information

Table 1: Directives



2002/95/EC	Directive of the European Parliament and of the Council of 27 January 2003 on the restriction of the use of certain hazardous substances in electrical and electronic equipment (RoHS)	
2002/96/EC	Directive of the European Parliament and of the Council on waste electrical and electronic equipment (WEEE)	
2003/108/EC	Directive of the European Parliament and of the Council of 8 December 2003 amending directive 2002/96/ec on waste electrical and electronic equipment (WEEE)	

Table 2: Standards of the Ministry of Information Industry of the People’s Republic of China

SJ/T 11363-2006	“Requirements for Concentration Limits for Certain Hazardous Substances in Electronic Information Products” (2006-06).	
SJ/T 11364-2006	<p>“Marking for Control of Pollution Caused by Electronic Information Products” (2006-06).</p> <p>According to the “Chinese Administration on the Control of Pollution caused by Electronic Information Products” (ACPEIP) the EPUP, i.e., Environmental Protection Use Period, of this product is 20 years as per the symbol shown here, unless otherwise marked. The EPUP is valid only as long as the product is operated within the operating limits described in the Hardware Interface Description.</p> <p>Please see Table 3 for an overview of toxic or hazardous substances or elements that might be contained in product parts in concentrations above the limits defined by SJ/T 11363-2006.</p>	

Table 3: Toxic or hazardous substances or elements with defined concentration limits

Name of the part	Hazardous substances					
	(Pb)	(Hg)	(Cd)	(Cr(VI))	(PBB)	(PBDE)
Metal Parts	o	o	o	o	o	o
Circuit Modules	x	o	o	o	o	o
Cables and Cable Assemblies	o	o	o	o	o	o
Plastic and Polymeric parts	o	o	o	o	o	o

o:
Indicates that this toxic or hazardous substance contained in all of the homogeneous materials for this part is below the limit requirement in SJ/T11363-2006.

x:
Indicates that this toxic or hazardous substance contained in at least one of the homogeneous materials for this part *might exceed* the limit requirement in SJ/T11363-2006.

Revision History

Updates between document versions are cumulative. Therefore, the latest document version contains all updates made to previous versions.

Release Date	Firmware Version	Details
2014-01-17	1.00	First Release

Contents

Chapter 1.	Product Concept.....	7
1.1	Overview	7
1.2	Packing List.....	7
1.3	Specifications	9
1.4	Dimensions.....	10
Chapter 2.	Installation.....	11
2.1	Overview	11
2.2	LED Indicator	11
2.3	USB interface.....	11
2.4	Install SIM Card	12
2.5	Connect the External Antenna (SMA Type)	13
2.6	Connect the Modem to External Device.....	13
2.7	Mount the Modem	13
2.8	Power Supply	14
Chapter 3.	Operate the Modem	15
3.1	AT command Set	15
3.1.1	Install USB driver.....	15
3.1.2	Start SecureCRT	19
3.1.3	AT Command Examples	20
3.2	CSD Connection.....	21
3.2.1	Overview.....	21
3.2.2	Establishing a CSD Connection	21
3.2.3	Answering a CSD Connection	22
3.3	Using Short Message Service	23
3.3.1	Sending a Short Message.....	23
3.3.2	Reading a Short Message	24
3.3.3	Deleting a Short Message	25
3.4	Cellular Network Connection.....	25
3.4.1	Overview.....	25
3.4.2	Internet Access for PC.....	26
Chapter 4.	Appendix	33
4.1	GSM Alphabet	33
4.2	Troubleshooting	36
4.2.1	The modem's LED does not light:	36
4.2.2	The modem keep rebooting all the time:.....	37
4.2.3	Receiving "No Carrier" Message	37
4.3	Terms and Abbreviations	37

Chapter 1. Product Concept

1.1 Overview

Robustel GoRugged M1000 UP is a rugged cellular modem with USB interface and plastic enclosure offering state-of-the-art 2G (GPRS/EDGE)/3G (HSPA/EV-DO)/4G (LTE) connectivity for machine to machine (M2M) applications.

- Control via AT commands.
- USB 2.0 high speed interface allows it to manage and optimize the performances of 3G and 4G high-speed networks.
- LTE downlink/uplink up to 100/50 Mbps.
- Antenna diversity for improved fringe performance optional.
- Comprehensive SDK and enabling drivers for Linux and Windows.
- 1 mini USB 2.0 high speed interface.
- Wide range input voltages from 6 to 26 VDC and extreme operating temperature.
- The plastic enclosure can be mounted on a DIN-rail or on the wall, also with extra ground screw.

1.2 Packing List

Check your package to make certain it contains the following items:

- Robustel GoRugged M1000 UP modem x1



- 3.5mm 2-pin pluggable terminal block for power connector x1



- CD with user guide and USB driver x1

Note: Please notify your sales representative if any of the above items are missing or damaged.

Optional accessories (can be purchased separately):

- SMA antenna (Stubby antenna or Magnet antenna optional) x1

Stubby antenna



Magnet antenna



- Mini USB cable x1



- Wall Mounting Kit



- 35mm Din-Rail mounting kit



- AC/DC Power Supply Adapter (12VDC, 1A) x1



1.3 Specifications

Cellular Interface

- Standards: LTE (DL/UL up to 100/50 Mbps), HSPA+/HSUPA/HSDPA/UMTS, EDGE/GPRS, EVDO 450
- Frequency: Please refer to “**Selection and Ordering Data**”
- SIM: 1 x (3V & 1.8V)
- Antenna Interface: SMA Female

USB Interface

- Number of Ports: 1 x mini USB Female
- Speed: USB 2.0 High Speed (480 Mbit/s)
- ESD Protection: 15KV

GPS (optional for M1000-UP3P and M1000-UP4L)

- Protocol: NMEA
- Modes: Standalone GPS, Assisted GPS

Drivers

- Drivers: Windows 2000/XP/Vista/7/CE, Linux 2.6

System

- LED Indicators: RUN

Power Supply and Consumption

- Power Supply Interface: 2-pin 3.5mm pluggable terminal block
- Input Voltage: 6 to 26 VDC
- Power Consumption: Idle: 50-60 mA@12 V
Data Link: 100 to 200 mA (peak)@12 V

Physical Characteristics

- Housing & Weight: Plastic, 105g
- Dimension(L x W x H): 75 x 85 x 28 mm
- Installation: 35mm Din-Rail or wall mounting or desktop

Selection and Ordering Data

Model No.	Air Interface	Frequency	Operating Environment
M1000-UP4L	LTE/HSPA+/UMTS/EDGE/GPRS	LTE 800/900/1800/2100/2600 MHz (DL/UL up to 100/50 Mbps) UMTS 900/2100 MHz, GSM 900/1800/1900 MHz	-25 to 60°C/5 to 95% RH
M1000-UP3P	HSPA+/UMTS/EDGE/GPRS	UMTS 850/900/1900/2100 MHz (DL/UL 14.4/5.76 Mbps) , GSM Quad Band	-40 to 85°C/5 to 95% RH
M1000-UP3H	HSUPA/UMTS/EDGE/GPRS	UMTS 900/2100 MHz (DL/UL 7.2/5.76 Mbps), GSM 900/1800 MHz	-40 to 85°C/5 to 95% RH
M1000-UP3E	EVDO 450 Rev. B/Rev. A	EVDO 450 MHz (DL/UL 14.7/5.4 Mbps)	-20 to 60°C/5 to 95% RH
M1000-UP	mPCIe interface	w/o module, mPCIe interface	-40 to 85°C/5 to 95% RH

1.4 Dimensions

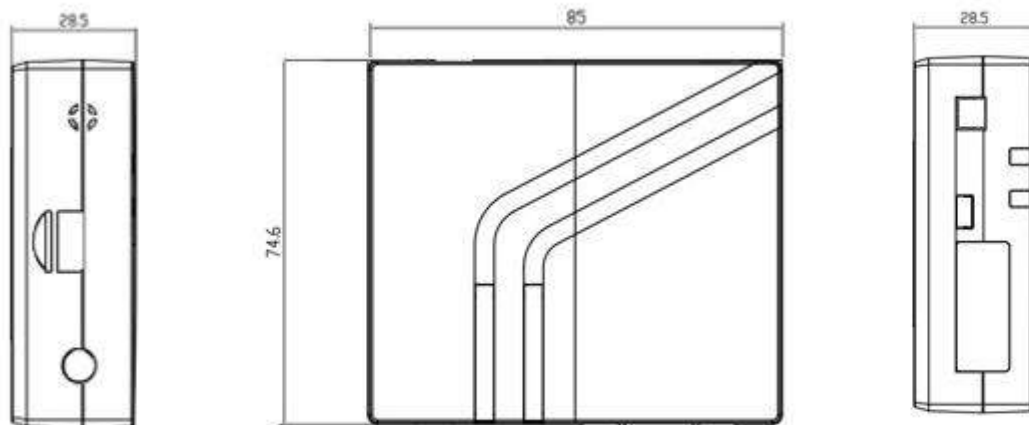

Chapter 2. Installation

2.1 Overview

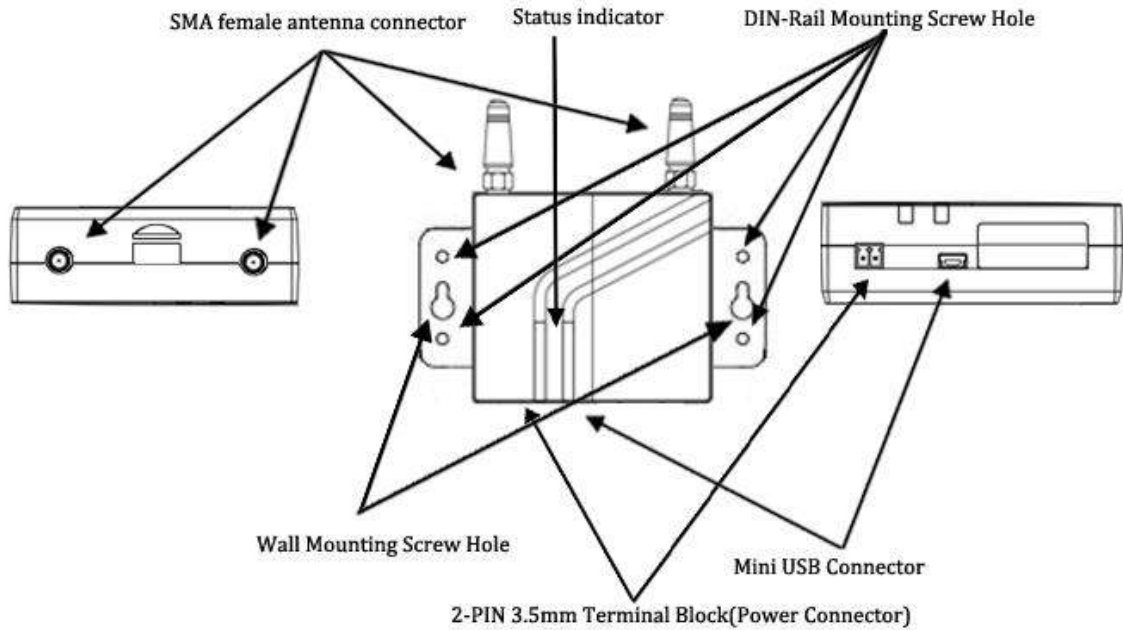

2.2 LED Indicator



Name	Color	Status	Description
RUN	Green	On	M1000 UP is powered up.
		Off	M1000 UP is powered off.

2.3 USB interface

USB interface can be used for configuration, sending/receiving data and power supply. When USB interface of M1000 UP is used for sending/receiving data as well as power supply, current/voltage output of USB interface which connects to M1000 UP's USB interface shall at least reach **1A/5V**.

Note: Normally, current/voltage output of PC's USB 2.0 interface is only 0.5A/5V. So when you use USB interface for sending/receiving data, you should use power input interface for power supply (please check section 2.8).

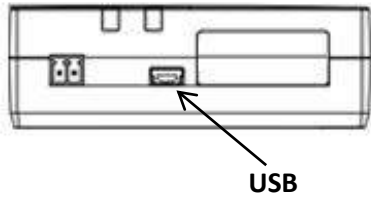

2.4 Install SIM Card

Be sure to insert a SIM card before you use the modem.

Note: A SIM card set with PIN code cannot be used normally in the modem without the correct PIN code.

Make sure to disconnect the adapter and switch off your modem before inserting or removing your SIM/USIM card.



■ Inserting SIM Card

1. Make sure your adapter is disconnected.
2. Insert the SIM card, and you need press the SIM card with your fingers until you hear "a cracking sound".

■ Removing SIM card

1. Make sure your adapter is disconnected.
2. Press the SIM card until you hear "a cracking sound", then the SIM card will pop up to be pulled out.

Note:

1. Don't touch the metal surface of the SIM card in case information in the card is lost or destroyed.
2. Don't bend or scratch your SIM card. Keep the card away from electricity and magnetism.
3. Make sure to disconnect the power source from your modem before inserting and removing your SIM card.

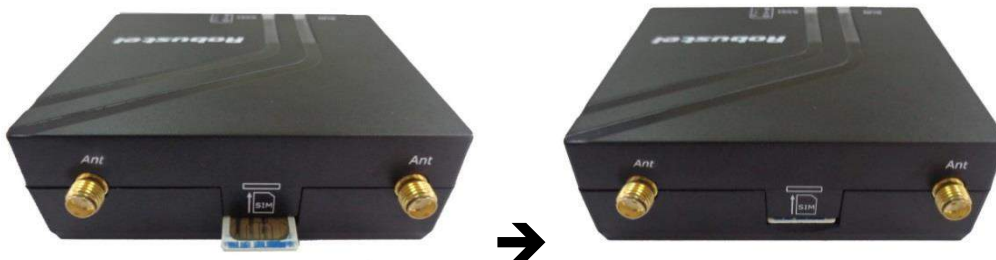

2.5 Connect the External Antenna (SMA Type)

Connect this to an external antenna with SMA male connector. Make sure the antenna is for the correct frequency as your GSM/GPRS/UMTS/HSPA operator with impedance of 50ohm, and also connector is **screwed** tightly.

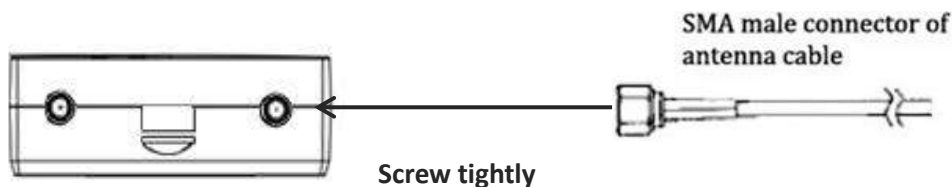

2.6 Connect the Modem to External Device

User can use the USB cable to connect the modem's Mini USB Connector to external slave devices / controller / computer.

Note: User needs to install relevant USB driver to PC, which you can find out in the CD.

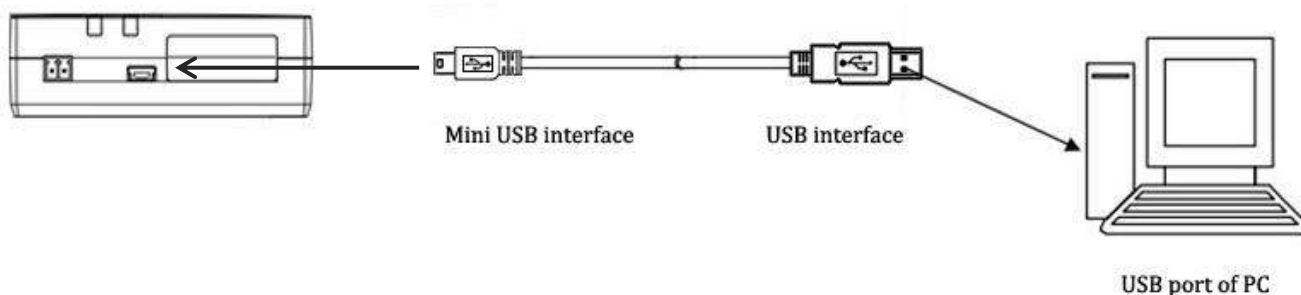

2.7 Mount the Modem

Use 2 pcs of M3 screw to mount the modem on the wall.

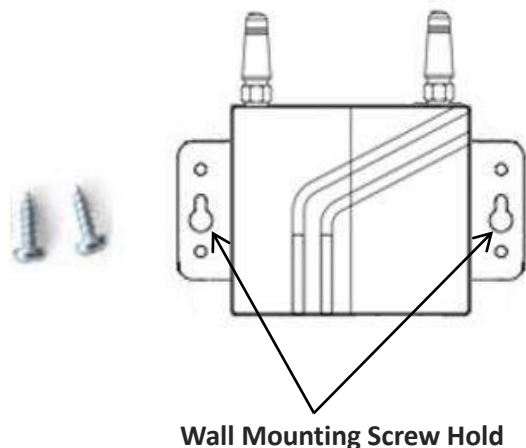

Or to mount the modem on a DIN rail, you need three pcs of M3 screws.



2.8 Power Supply

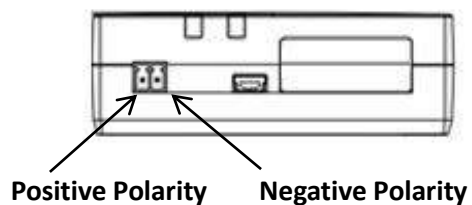

The power supply range is 6 to 26 VDC.

Note: Please take care about the polarity, and do not make reverse connection.

Chapter 3. Operate the Modem

3.1 AT command Set

We can operate and configure M1000 UP via AT commands through mini USB port. This chapter will introduce how to install USB driver and AT command examples while configuring M1000 UP.

3.1.1 Install USB driver

1. In the Control Panel, when you connect USB cable to PC, it will pop up tab **Other devices** and show M1000 UP's module version.

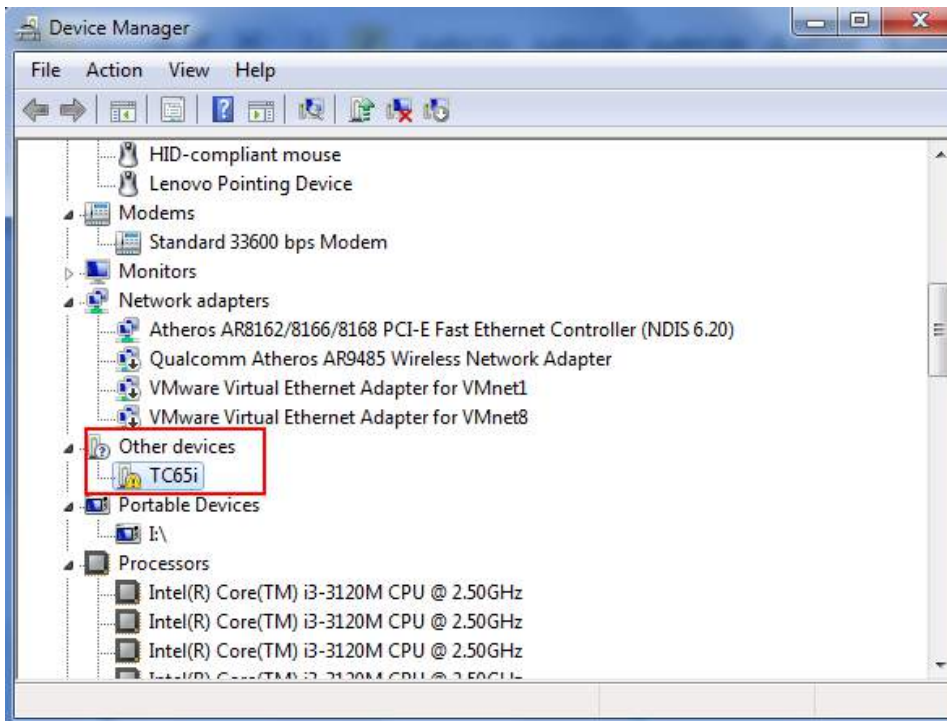

2. Right-click to enter **Properties** and then click **Update Driver**.

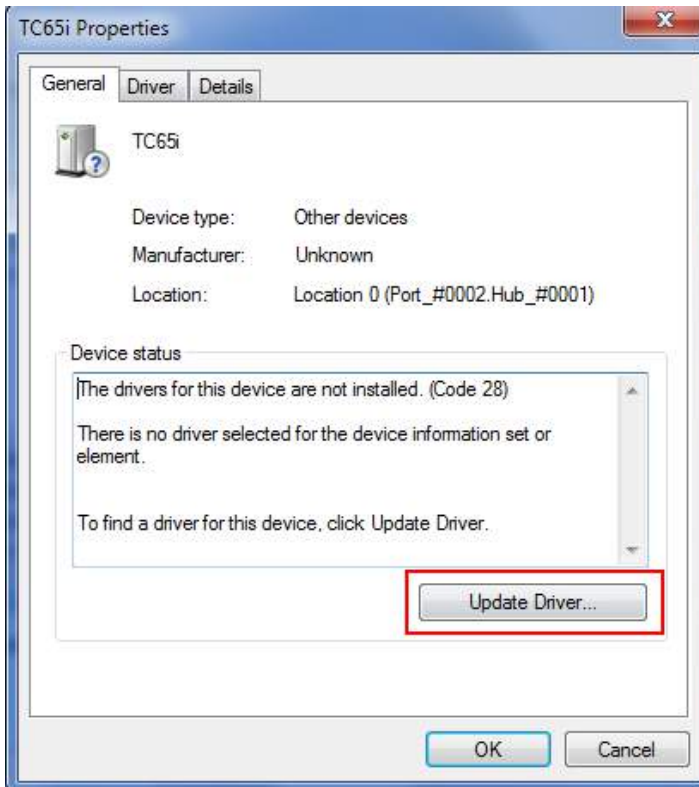

3. Click **Browse my computer for driver software**.

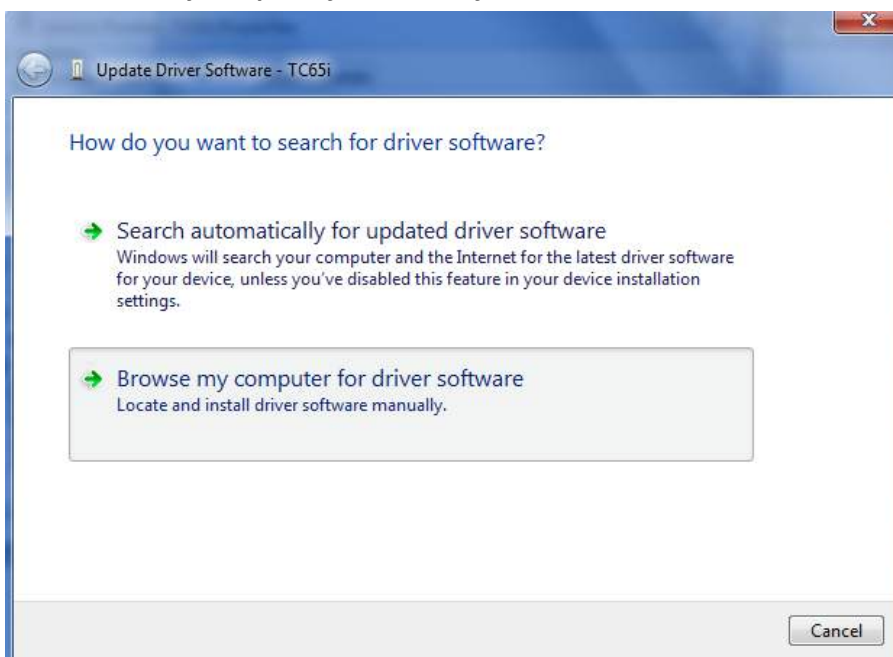

4. Click **Browse** to locate to position of the USB driver (you can find out relevant USB driver in the CD), then click **Next**.

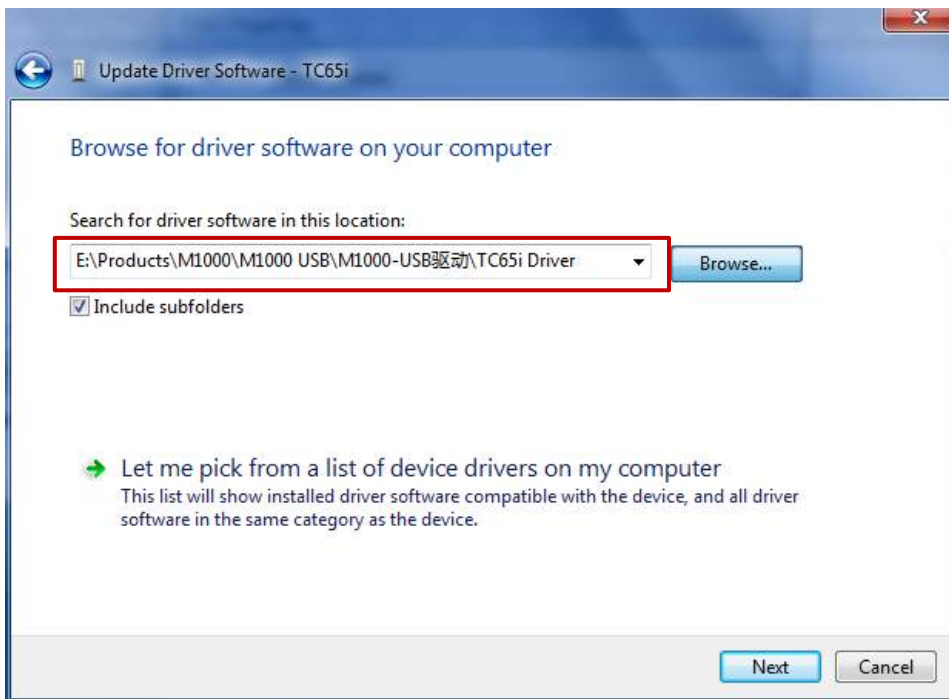

5. After succeeding to install the USB driver, it will pop up the following window.

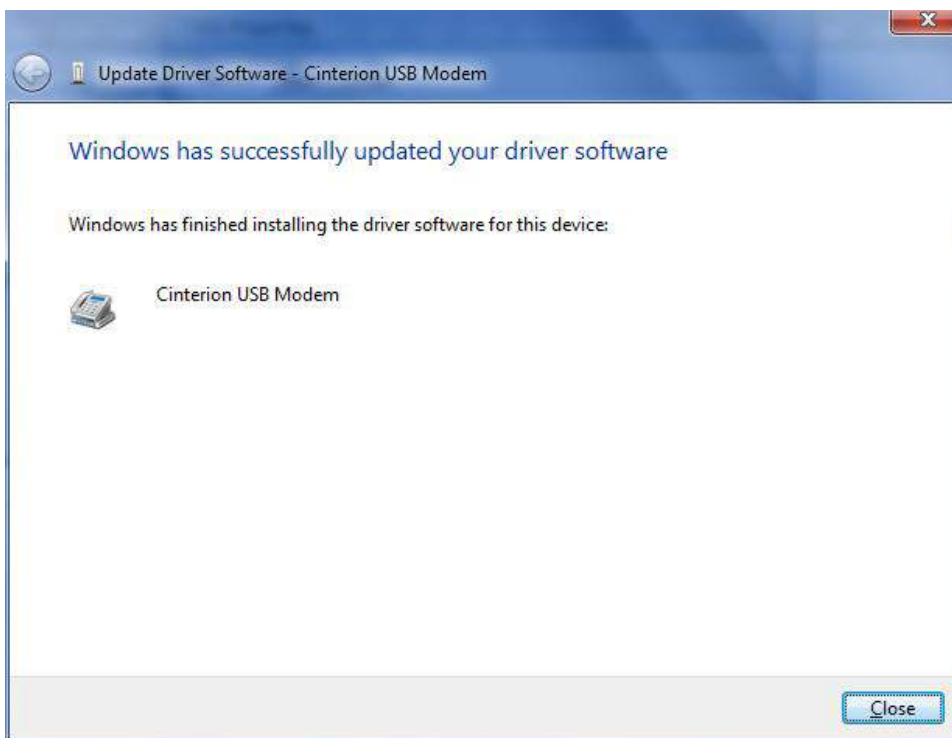

6. A simulated virtual COM port which binds to the USB interface of M1000 UP will open after USB driver has been installed. Please check "Device Manager" -> "Modems".

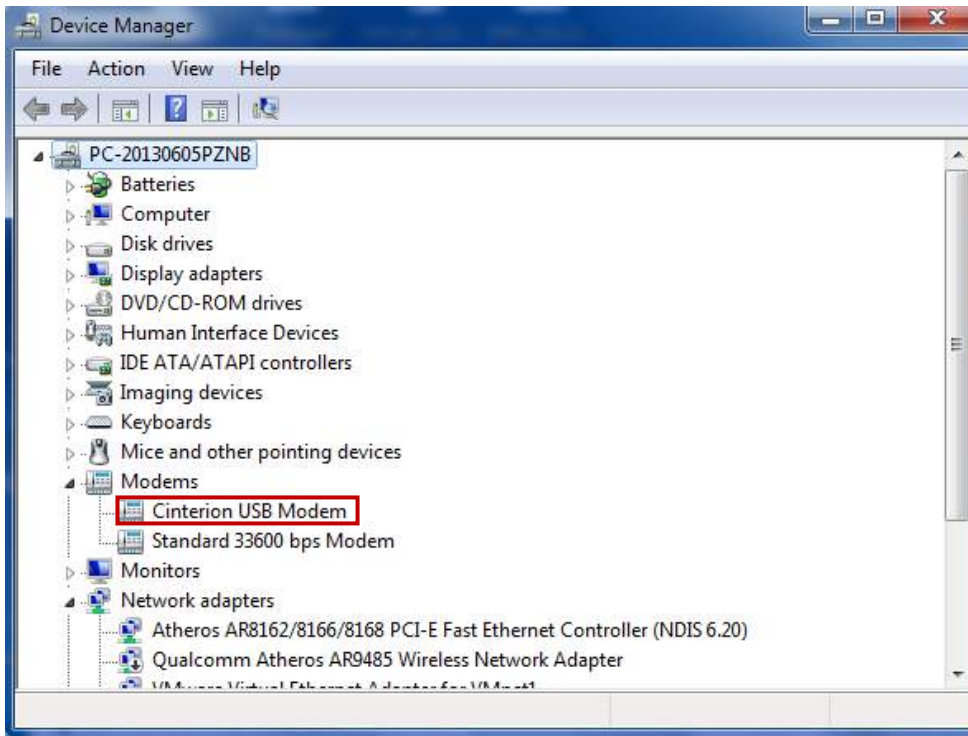

7. Select the USB modem and right-click to enter "Properties". In tab "Modem", you will find that there is simulated COM port which serial software such as secureCRT needs to connect to.

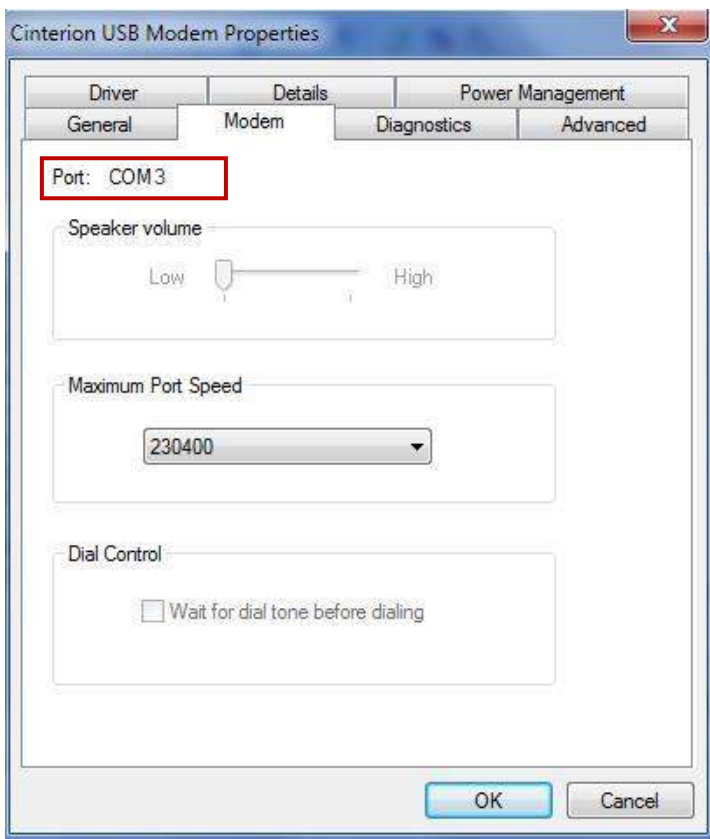

3.1.2 Start SecureCRT

We can enter AT commands to configure M1000 UP from serial software such as **secureCRT**, you can download this software via link: <https://app.box.com/s/arn6xk1asgs1myvuue>.

1. Double click SecureCRT Potable.exe .



2. File->Connect->New Session

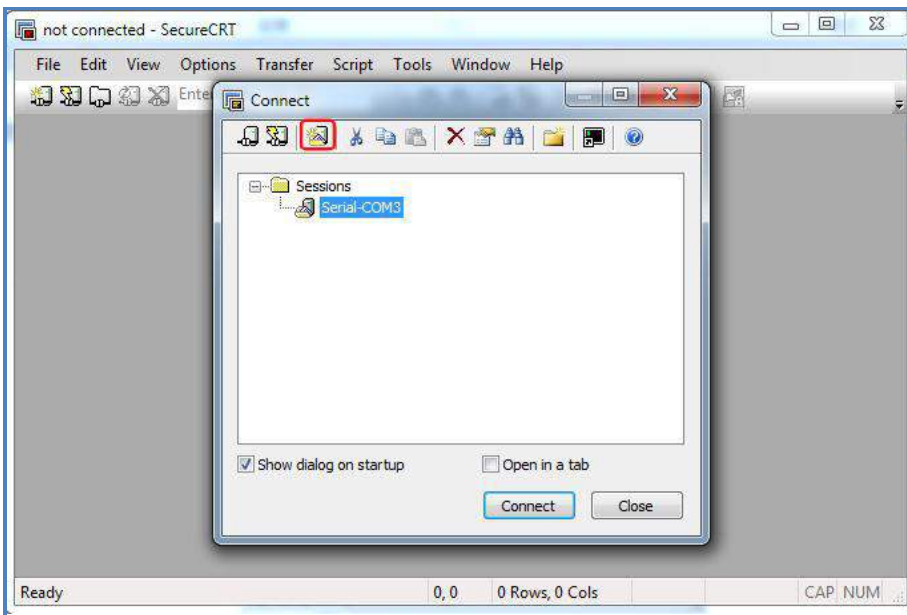

3. Select Protocol as "Serial".

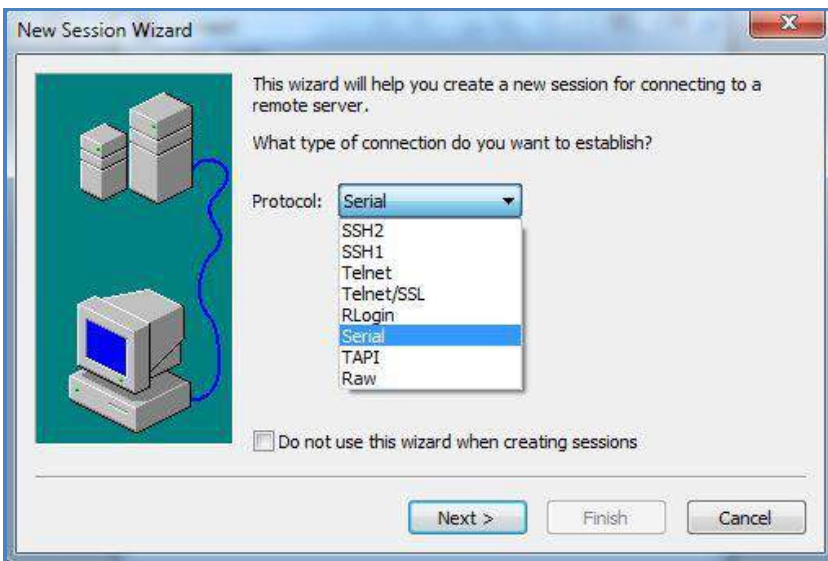

4. Select the simulated COM port and match the parameters as below, click the “Next” button to finish this session.

Note: You need to disable “RTS/CTS”.

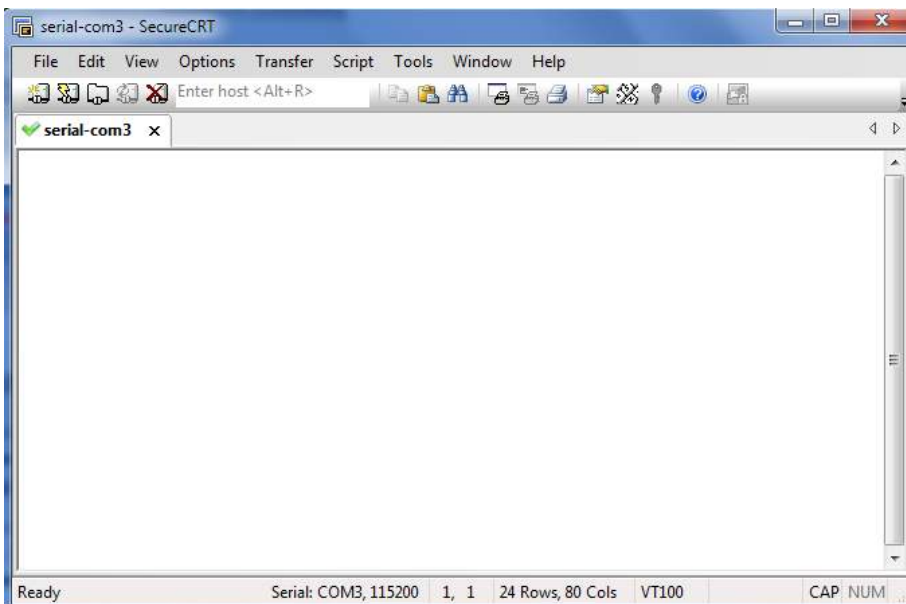
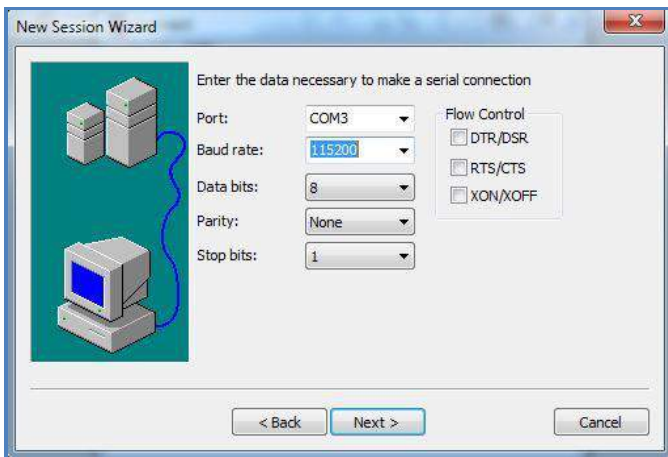

3.1.3 AT Command Examples

M1000 UP supports the guidelines known as the “AT Command Set.” AT Command Set is the industry standard line-oriented command language used to communicate with the modem.

Followings are examples of some AT commands. Please refer to the AT command guide for a full description.

Description	AT commands	Modem response	Comments
Modem acknowledgement	AT	OK	Responding OK indicates that the modem is ready.
Receiving signal strength	AT+CSQ	+CSQ: 19,99	The first parameter has to be at least 15 for normal communication.
Query current PIN status	AT+CPIN?	+CPIN: READY	SIM card is correctly inserted and modem is not pending for any password

		+CPIN: SIM PIN	PIN1 is required
		+CPIN: SIM PUK	PUK1 is required
Saves parameters in non-volatile memory	AT&W	OK	The configuration settings are stored.

3.2 CSD Connection

3.2.1 Overview

A Circuit-Switched Data Connection makes the wireless modem work in a manner similar to a regular analog modem. CSD (Circuit Switched Data) is the original form of data transmission developed for cellular systems. By using a single radio time slot, CSD is able to deliver 9.6 to 14.4 kbit/s data transmission to both the CELLULAR Network and PSTN Switching Subsystem through direct calls. Most of the time, it is initiated by standard AT commands. Using the modem to access remote devices by CSD is often more convenient than installing cables and data lines. Data collection and monitoring will be more flexible since CSD can be used for applications that are hard to wire or hard to access.

Note: Ensure that your SIM card has the CSD Service activated. For most regions, you must apply to your mobile service provider to receive this service.

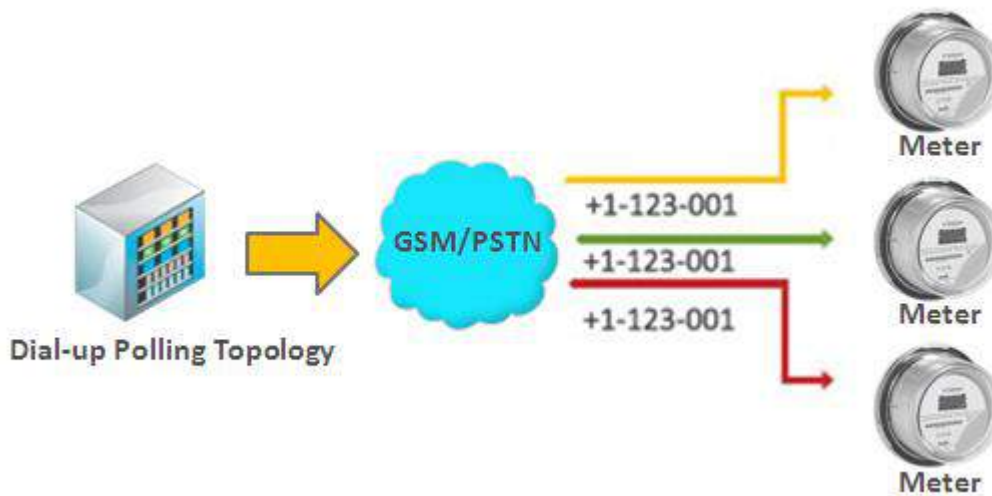

3.2.2 Establishing a CSD Connection

1. Start SecureCRT with serial parameters 115200,8,n,1.
2. Type **ATD <phone number>** and press **Enter** to establish a CSD connection. (e.g. ATD 123456, in which 123456 is the phone number.)
3. After remote side answering the CSD call, then the CSD connection has been established successfully.
4. To close the CSD connection, type **+++**. The modem will respond with OK to indicate that you have already switched back to the command mode. It means you can enter AT commands again via SecureCRT.
5. Type **ATH** and press **Enter** to disconnect.

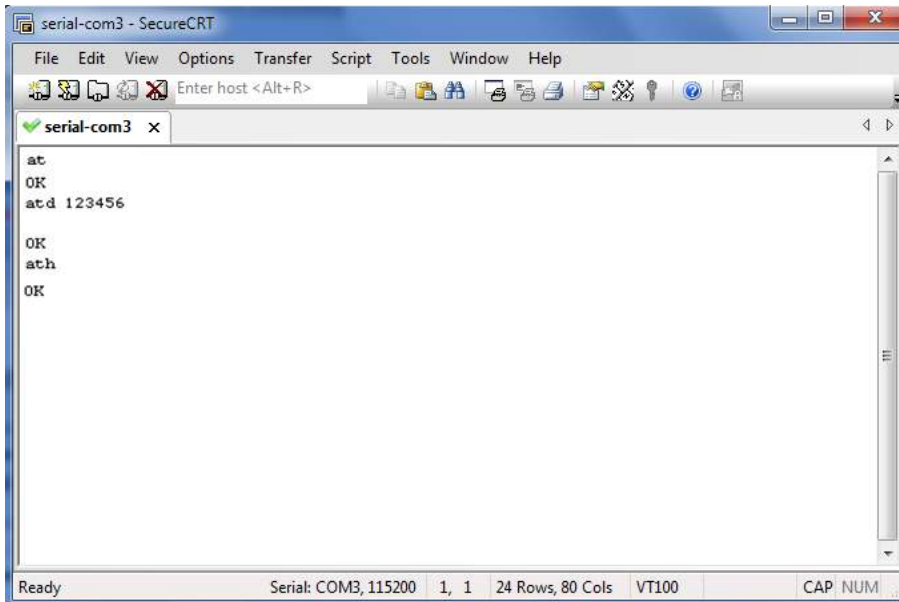

```
serial-com3 - SecureCRT
File Edit View Options Transfer Script Tools Window Help
Enter host <Alt+R>
serial-com3 x
at
OK
at.d 123456
OK
ath
OK
Ready Serial: COM3, 115200 1, 1 24 Rows, 80 Cols VT100 CAP NUM
```

Note:

- **+++** is the escape sequence, and **ATH** is the hang-up command.
- For international calls, the local international prefix does not need to be set, but does need to be replaced by the **+** character. E.g., you would type **ATD+86123456**, in which **+86** is the country code.

3.2.3 Answering a CSD Connection

1. When secureCRT displays the RING response, type **ATA**, and press **Enter**.

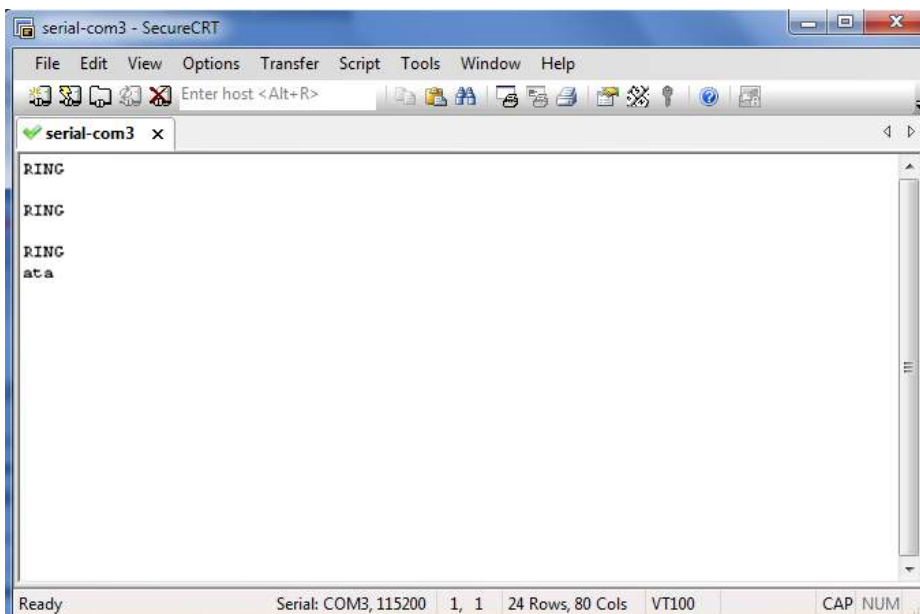

```
serial-com3 - SecureCRT
File Edit View Options Transfer Script Tools Window Help
Enter host <Alt+R>
serial-com3 x
RING
RING
RING
ata
Ready Serial: COM3, 115200 1, 1 24 Rows, 80 Cols VT100 CAP NUM
```

2. In the secureCRT window, type **ATS0=x** and press Enter. For **x**, substitute the number of rings that the modem should receive before answering the call. For example, to answer after the first ring, type **ATS0=1**.
3. Type **AT&W** and press Enter.

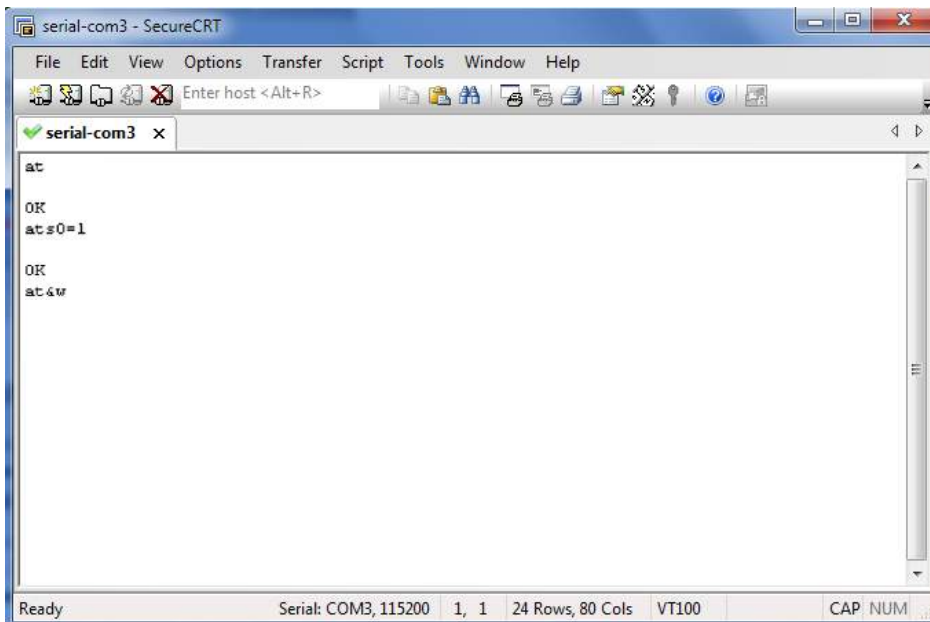

4. To close the CSD connection, type **+++**. The modem will respond with OK to indicate that you have already switched back to the command mode.
5. Type **ATH** and press Enter to disconnect.

3.3 Using Short Message Service

Cellular technology offers the benefit of using SMS (short message service) as an easy way to communicate over the mobile network.

The following topics are covered in this chapter:

1. Sending a Short Message
2. Reading a Short Message
3. Deleting a Short Message

3.3.1 Sending a Short Message

1. Type **AT+CMGF=1** and press **Enter**.
2. Type **AT+CMGS="<phone number>"** and press **Enter**. The terminal will automatically move to the next line, which starts with >. Type your message on the right of the >.
3. Enter **Ctrl + Z** deliver the message.

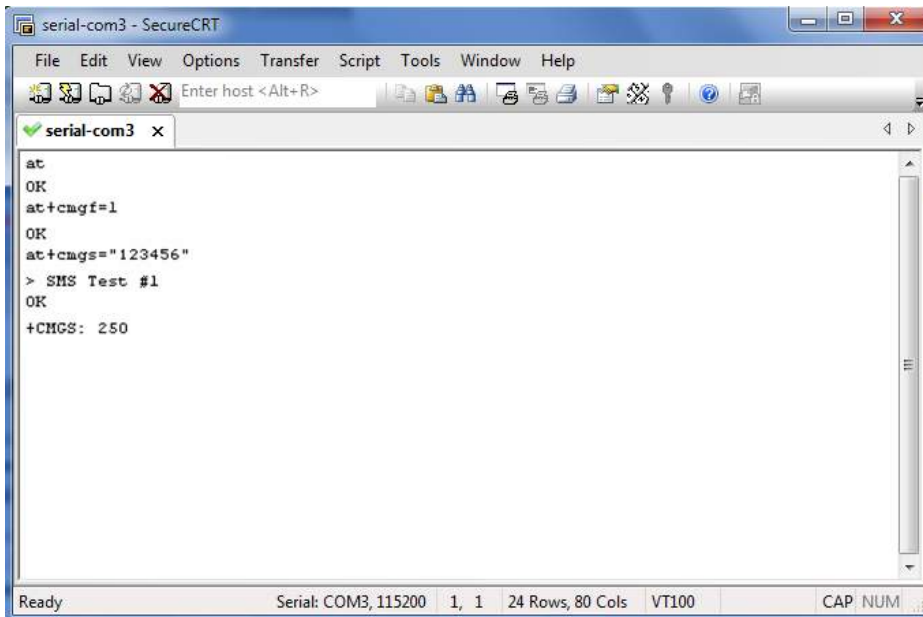

```
serial-com3 - SecureCRT
File Edit View Options Transfer Script Tools Window Help
Enter host <Alt+R>
serial-com3 x
at
OK
at+cmgf=1
OK
at+cmgs="123456"
> SMS Test #1
OK
+CMGS: 250
Ready Serial: COM3,115200 1, 1 24 Rows, 80 Cols VT100 CAP NUM
```

Note: *AT+CMGF=1* sets the SMS to Text mode.

3.3.2 Reading a Short Message

1. Type **AT+CMGF=1** and then press **Enter**.
2. Type **AT+CNMI=2,1** and then press **Enter**.
3. When a short message is received, the modem will show the storage number of the message after “**+CMIT: “SM”, x**” (where the **x** is the storage number).
4. Type **AT+CMGR=x** to read the message.
5. In the example shown below, the **x=5** means that the message is stored in the 5th storage location.

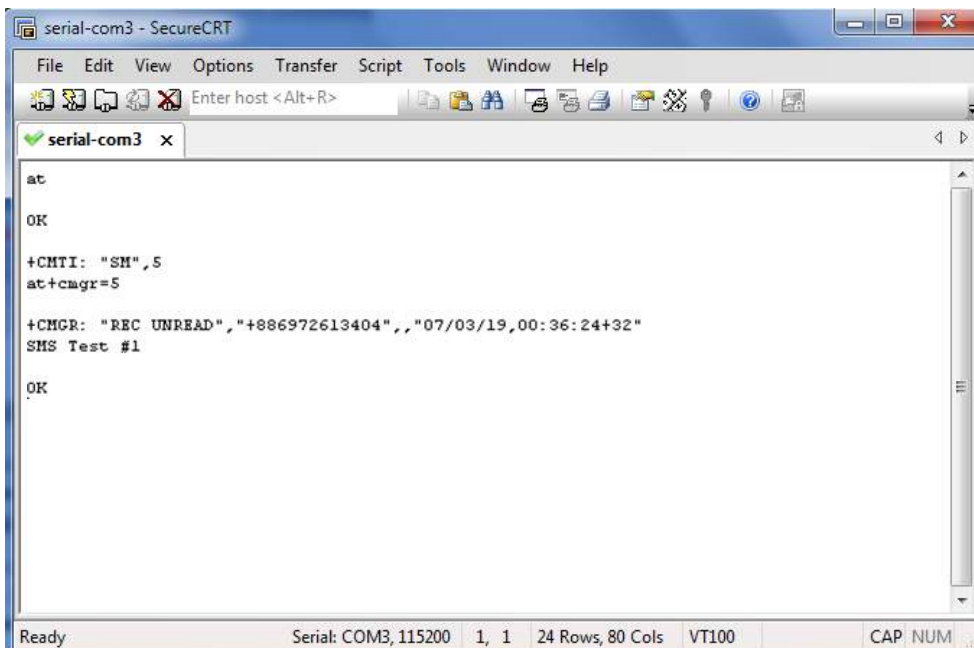

```
serial-com3 - SecureCRT
File Edit View Options Transfer Script Tools Window Help
Enter host <Alt+R>
serial-com3 x
at
OK
+CMIT: "SM",5
at+cmgr=5
+CMGR: "REC UNREAD","+886972613404",,"07/03/19,00:36:24+32"
SMS Test #1
OK
Ready Serial: COM3,115200 1, 1 24 Rows, 80 Cols VT100 CAP NUM
```

3.3.3 Deleting a Short Message

Type **AT+CMGD=*x*,*n*** and then press **Enter**.

This is where ***x*** represents one of the following options:

- “**REC UNREAD**” Shows received unread messages.
- “**REC READ**” Shows received read messages.
- “**STO UNSENT**” Shows stored unsent messages.
- “**STO SENT**” Shows stored sent messages.
- “**ALL**” Shows messages.

This is where ***n*** represents one of the following options:

- 0** Delete message at location <include the index number>
- 1** Delete all READ messages.
- 2** Delete all READ and SENT messages.
- 3** Delete all READ, SENT, and UNSENT messages.
- 4** Delete ALL messages. “**REC UNREAD**” Shows received unread messages.

Note: Refer to the Documentation and Software CD / AT_Commands / AT_Commands.pdf for further detail commands information using SMS.

3.4 Cellular Network Connection

3.4.1 Overview

A cellular network is a wireless network distributed over land areas called cells, each served by at least one fixed-location transceiver, known as a cell site or base station. We can use our mobile phones or PCs to connect to cellular network basing on 2G (GPRS/EDGE)/3G (HSPA/EV-DO)/4G (LTE) technology.

M1000 UP offers state-of-the-art 2G (GPRS/EDGE)/3G (HSPA/EV-DO)/**4G (LTE)** connectivity for machine to machine (M2M) applications, it can provide cellular network connection for end-user devices such as PCs, embedded computers, and PLCs that are PPP-enabled and can be easily connected to the cellular network and the Internet.

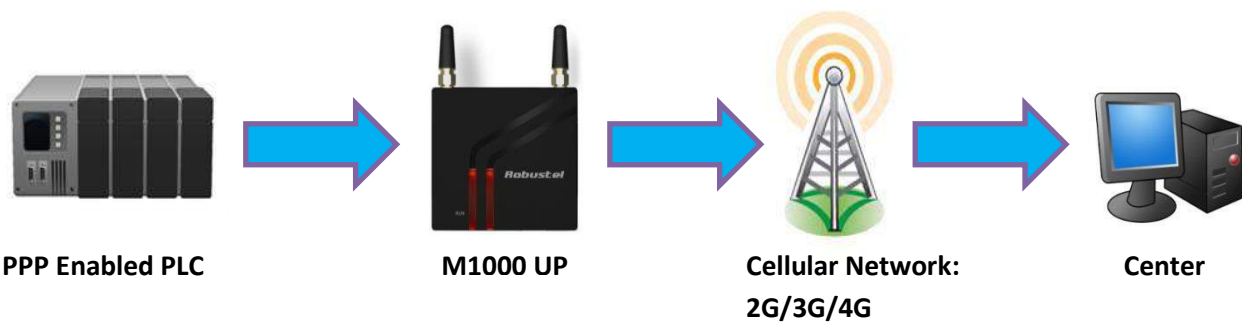

3.4.2 Internet Access for PC

The modem can use Windows DUN (Dial-up Networking) to provide the Internet access through the cellular network. Instructions are described in the following chapters.

Note: *The specific steps may vary depending on your version of Windows and your Windows settings. Following steps are basing on Windows 7.*

● Change baudrate of modem

1. You can set baudrate of the simulated COM port to highest speed following the diagram below. The highest speed of the simulated port varies from different module of M1000 UP, you can use AT command "AT+IPR=?" to check baudrate details. In this document, we use AT command "AT+IPR=230400" to set baudrate of the simulated COM port to 230400.

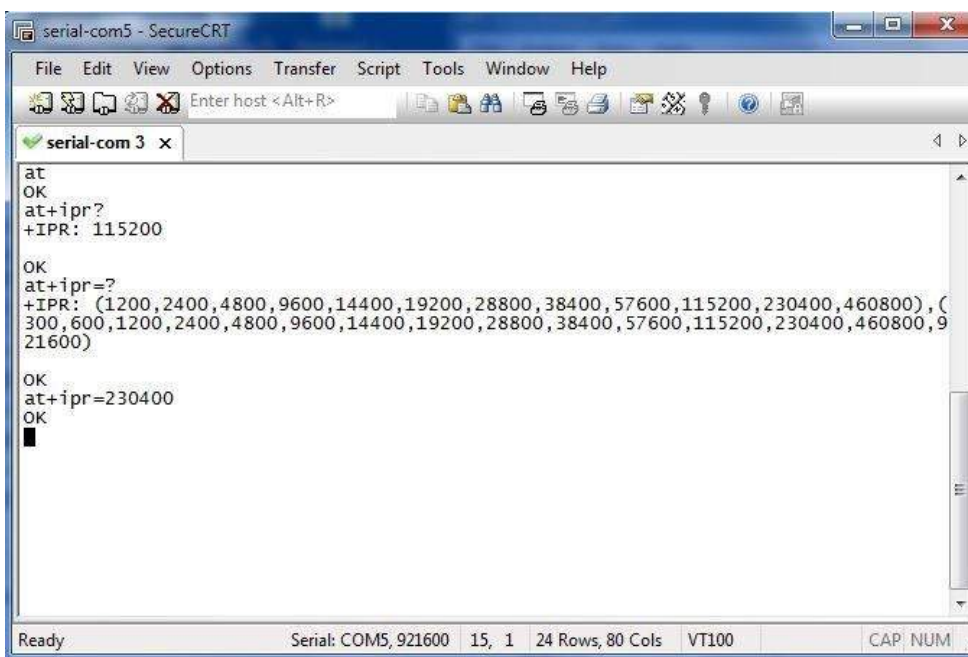

```
serial-com5 - SecureCRT
File Edit View Options Transfer Script Tools Window Help
Enter host <Alt+R>
serial-com 3 x
at
OK
at+ipr?
+IPR: 115200

OK
at+ipr=?
+IPR: (1200,2400,4800,9600,14400,19200,28800,38400,57600,115200,230400,460800), (300,600,1200,2400,4800,9600,14400,19200,28800,38400,57600,115200,230400,460800,921600)

OK
at+ipr=230400
OK
█

Ready Serial: COM5,921600 15, 1 24 Rows, 80 Cols VT100 CAP_NUM
```

● Set Maximum Port Speed

1. In the Control Panel, Select the USB modem in tab **Device Manager** -> **Modems** -> **XXX USB modem**.

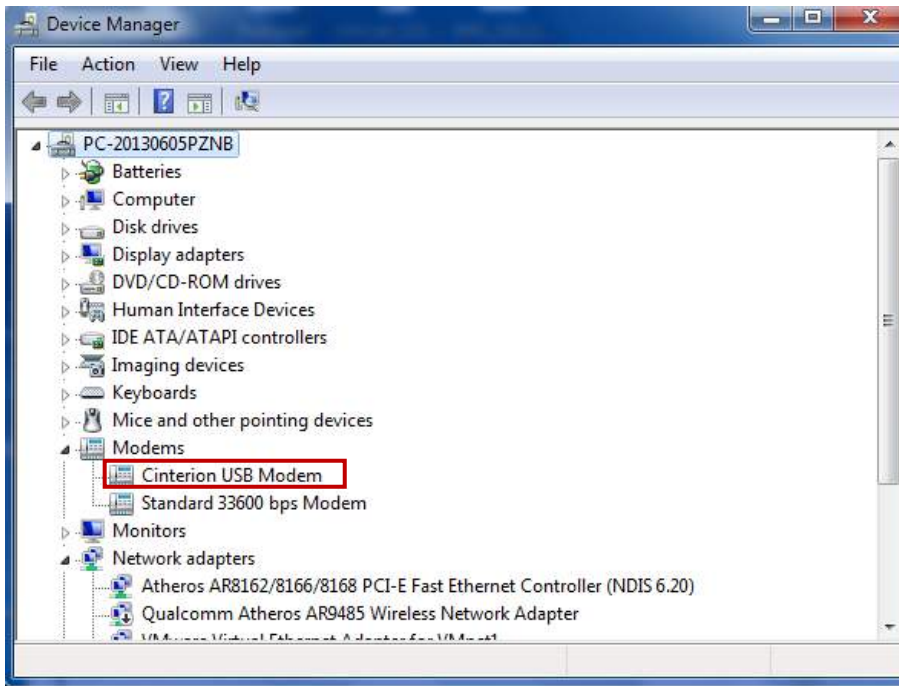

2. Right-click to enter **Properties**. You can select the maximum port speed as 230400 in tab **Modem**.

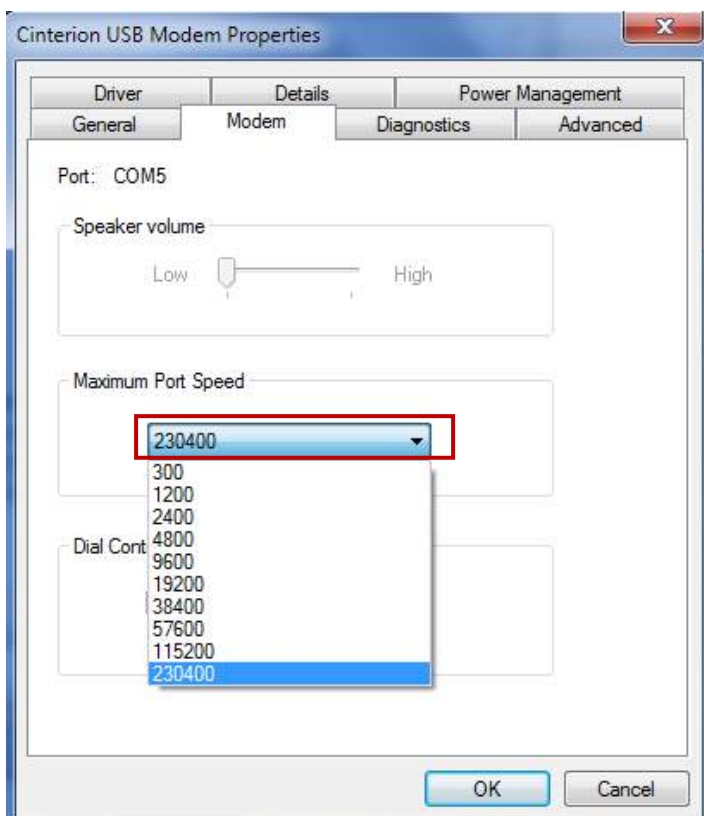

- **Modem Diagnostics**

Follow these steps to verify that the modem is installed properly and has been activated.

1. Click the **Diagnostics** tab, and then click **Query Modem**. After that it will popup "Please Wait" window. This process will almost take you 4 seconds.

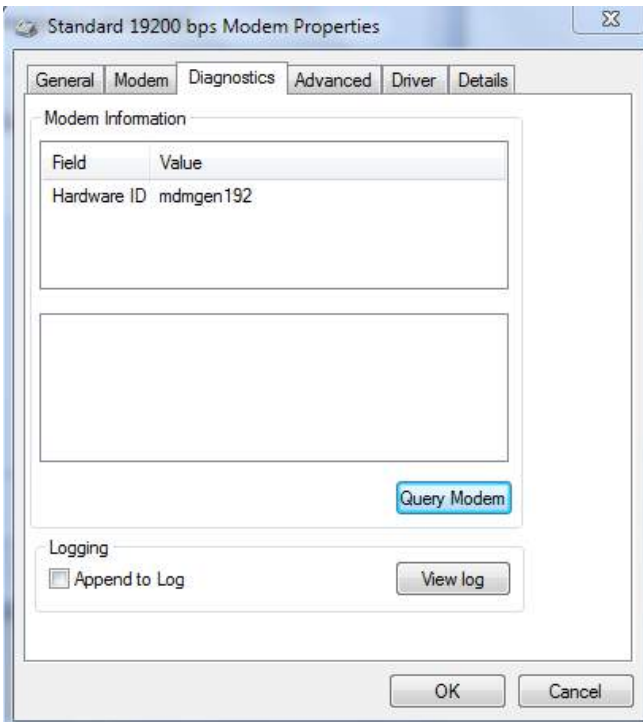

2. If the query is successful, both commands sent to the modem and responses from the modem will be displayed. Click OK to close the window.

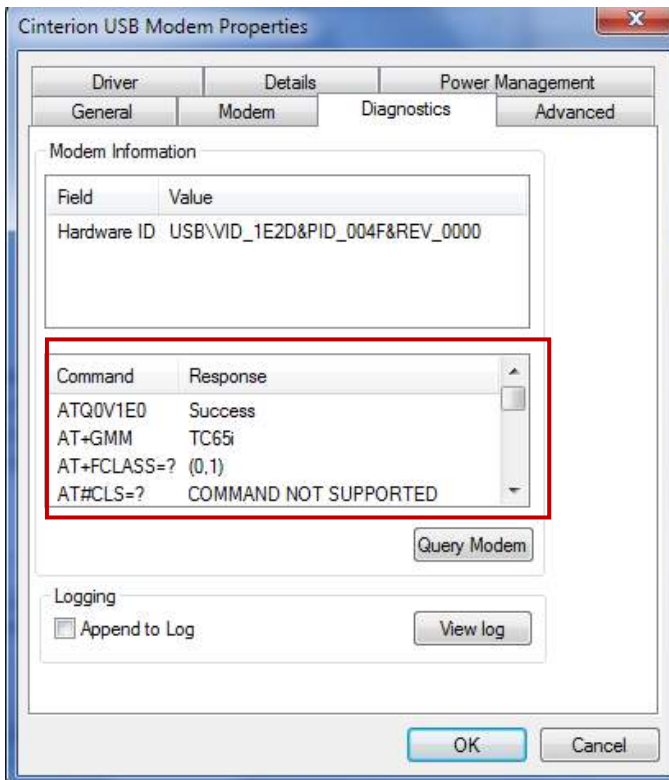

● **Adding Windows DUN**

Follow these steps to add Windows Dial-up Networking.

1. In the Control Panel, open **Network and Sharing Center**, and then click **Set up a new connection or network**.
2. When the **Set Up a Connection or Network** window opens, select the **Connect to the Internet** option, and then

click **Next**.

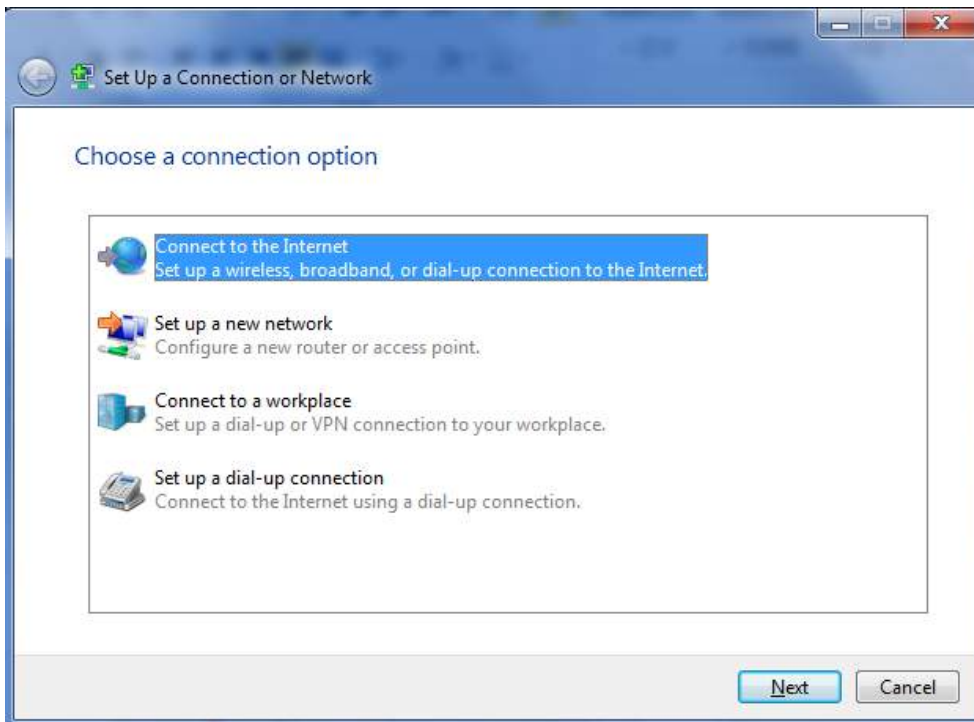

3. Select the **No, create a new connection** option, and then click **Next**.

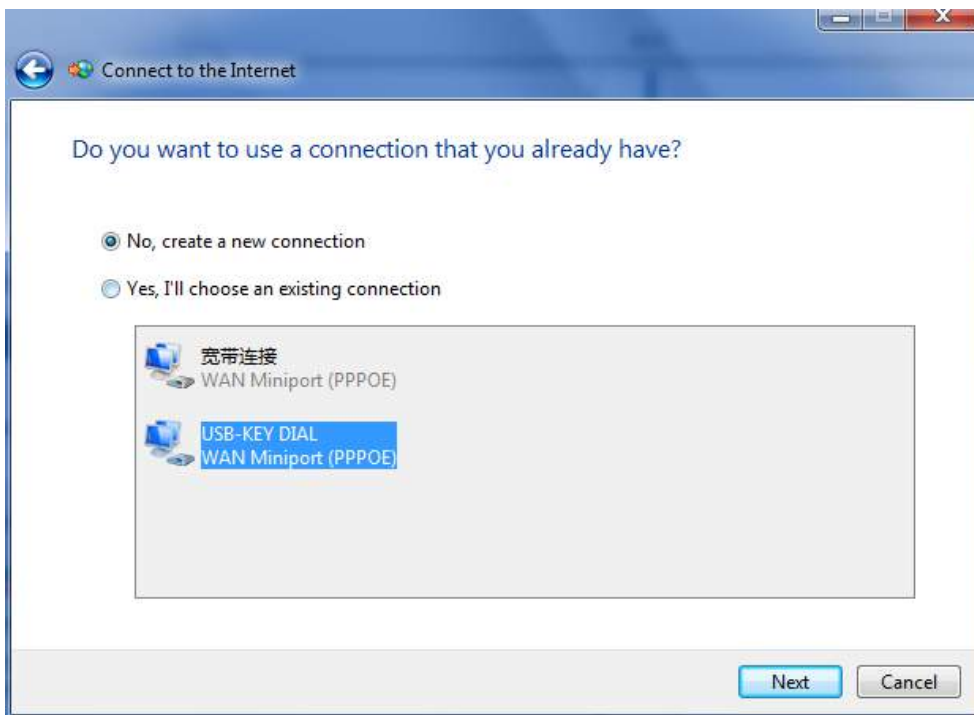

4. Select the **Dial-up** option.

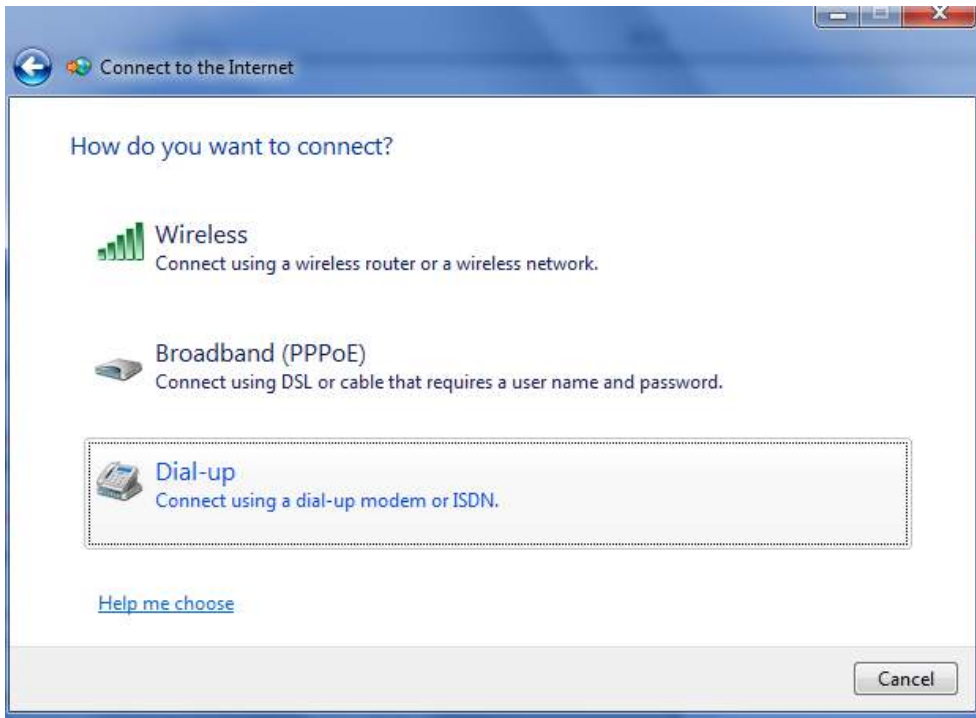

5. Select the correct USB Modem which is shown as the same as **Device Manager** -> **Modems** -> **XXX USB modem**.

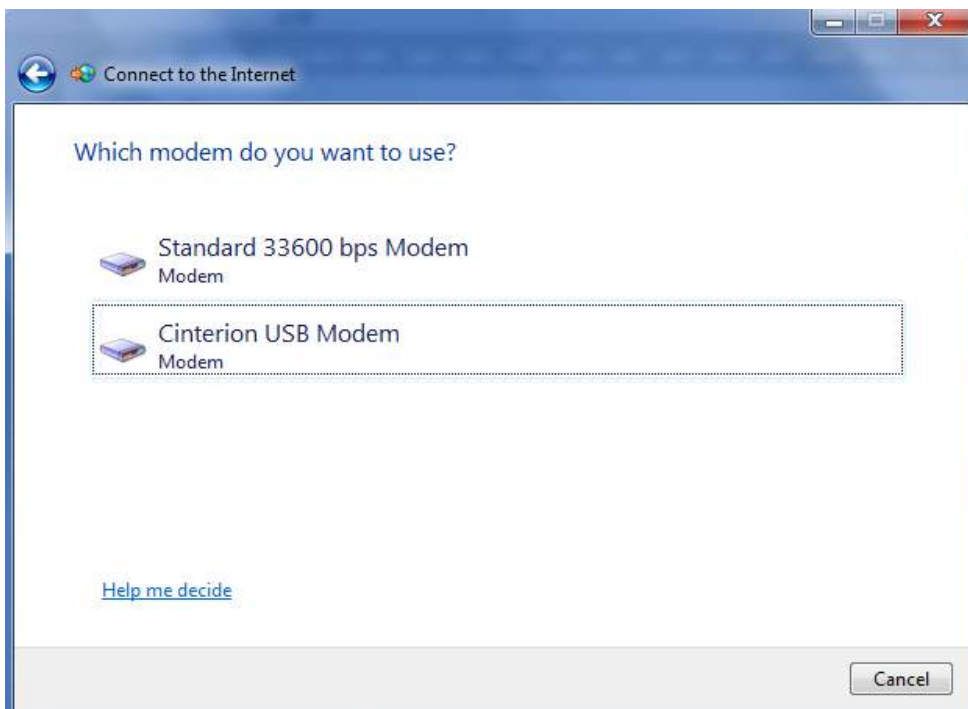

6. Type ***99***1#** in the Phone number text input box, and type the **User name** and **Password** in the appropriate text boxes, and then click **Connect**.

*Note: **User Name** and **Password** is used for cellular dial-up connection, you can check with local ISP whether you need to enter and what you need to enter.*

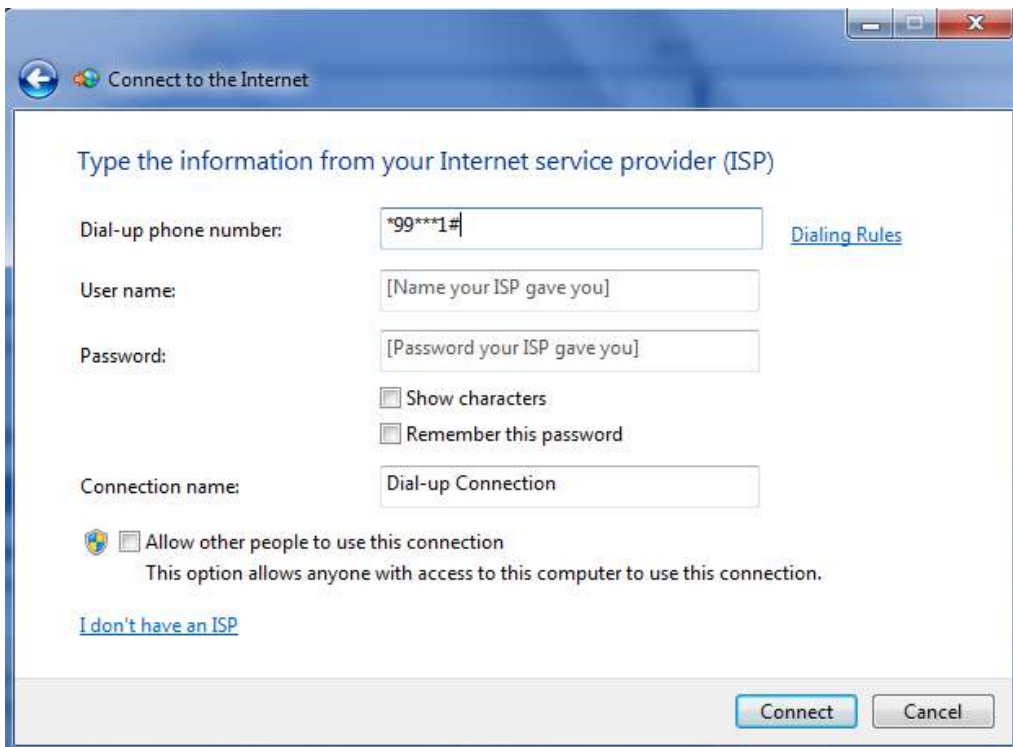

7. After dial up successfully, it will show window below.



8. Also you can try to ping to www.google.com to check whether GPRS connection has been established.

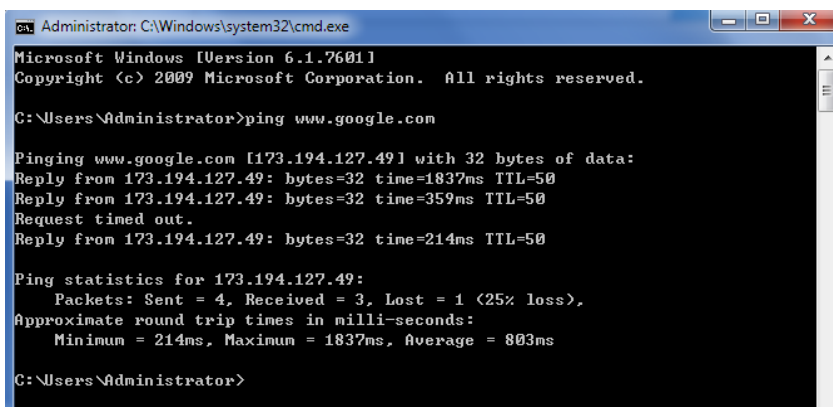

```
Administrator: C:\Windows\system32\cmd.exe
Microsoft Windows [Version 6.1.7601]
Copyright (c) 2009 Microsoft Corporation. All rights reserved.

C:\Users\Administrator>ping www.google.com

Pinging www.google.com [173.194.127.49] with 32 bytes of data:
Reply from 173.194.127.49: bytes=32 time=1837ms TTL=50
Reply from 173.194.127.49: bytes=32 time=359ms TTL=50
Request timed out.
Reply from 173.194.127.49: bytes=32 time=214ms TTL=50

Ping statistics for 173.194.127.49:
    Packets: Sent = 4, Received = 3, Lost = 1 (25% loss),
    Approximate round trip times in milli-seconds:
        Minimum = 214ms, Maximum = 1837ms, Average = 803ms

C:\Users\Administrator>
```

Chapter 4. Appendix

4.1 GSM Alphabet

Standard SMS can contain 160 characters. However, the characters typed must be part of the so-called 7-bit default alphabet as specified by GSM 3.38. You can see in the table below that this alphabet contains all ASCII characters and some accented characters.

For example, u umlaut (ü) and e with grave (è), are in this set. Please study the table below to have a complete overview. Using any character not in this set, will make the SMS a Unicode SMS and limit the length of the SMS to 70 characters.

Note: a few characters actually count as two characters. These characters are:

{ } [] ~ | \ and the Euro symbol: €

You can also see that in the table below in the hex column. These characters need to be escaped.

Below is the 7 bit default alphabet as specified by GSM 03.38. The corresponding ISO-8859-1 decimal codes are shown in the rightmost column. Note that the euro sign (€) is also included.

Hex	Dec	Character name	Character	ISO-8859-1 DEC
0x00	0	COMMERCIAL AT	@	64
0x01	1	POUND SIGN	£	163
0x02	2	DOLLAR SIGN	\$	36
0x03	3	YEN SIGN	¥	165
0x04	4	LATIN SMALL LETTER E WITH GRAVE	è	232
0x05	5	LATIN SMALL LETTER E WITH ACUTE	é	233
0x06	6	LATIN SMALL LETTER U WITH GRAVE	ù	249
0x07	7	LATIN SMALL LETTER I WITH GRAVE	ì	236
0x08	8	LATIN SMALL LETTER O WITH GRAVE	ò	242
0x09	9	LATIN CAPITAL LETTER C WITH CEDILLA	Ç	199
0x0A	10	LINE FEED		10
0x0B	11	LATIN CAPITAL LETTER O WITH STROKE	Ø	216
0x0C	12	LATIN SMALL LETTER O WITH STROKE	ø	248
0x0D	13	CARRIAGE RETURN		13
0x0E	14	LATIN CAPITAL LETTER A WITH RING ABOVE	Å	197
0x0F	15	LATIN SMALL LETTER A WITH RING ABOVE	å	229
0x10	16	GREEK CAPITAL LETTER DELTA	Δ	
0x11	17	LOW LINE	_	95
0x12	18	GREEK CAPITAL LETTER PHI	Φ	
0x13	19	GREEK CAPITAL LETTER GAMMA	Γ	
0x14	20	GREEK CAPITAL LETTER LAMBDA	Λ	
0x15	21	GREEK CAPITAL LETTER OMEGA	Ω	
0x16	22	GREEK CAPITAL LETTER PI	Π	
0x17	23	GREEK CAPITAL LETTER PSI	Ψ	

0x18	24	GREEK CAPITAL LETTER SIGMA	Σ	
0x19	25	GREEK CAPITAL LETTER THETA	Θ	
0x1A	26	GREEK CAPITAL LETTER XI	Ξ	
0x1B	27	ESCAPE TO EXTENSION TABLE		
0x1B0A	27 10	FORM FEED		12
0x1B14	27 20	CIRCUMFLEX ACCENT	^	94
0x1B28	27 40	LEFT CURLY BRACKET	{	123
0x1B29	27 41	RIGHT CURLY BRACKET	}	125
0x1B2F	27 47	REVERSE SOLIDUS (BACKSLASH)	\	92
0x1B3C	27 60	LEFT SQUARE BRACKET	[91
0x1B3D	27 61	TILDE	~	126
0x1B3E	27 62	RIGHT SQUARE BRACKET]	93
0x1B40	27 64	VERTICAL BAR		124
0x1B65	27 101	EURO SIGN	€	164 (ISO-8859-15)
0x1C	28	LATIN CAPITAL LETTER AE	Æ	198
0x1D	29	LATIN SMALL LETTER AE	æ	230
0x1E	30	LATIN SMALL LETTER SHARP S (German)	ß	223
0x1F	31	LATIN CAPITAL LETTER E WITH ACUTE	É	201
0x20	32	SPACE		32
0x21	33	EXCLAMATION MARK	!	33
0x22	34	QUOTATION MARK	“	34
0x23	35	NUMBER SIGN	#	35
0x24	36	CURRENCY SIGN	¤	164 (ISO-8859-1)
0x25	37	PERCENT SIGN	%	37
0x26	38	AMPERSAND	&	38
0x27	39	APOSTROPHE	'	39
0x28	40	LEFT PARENTHESIS	(40
0x29	41	RIGHT PARENTHESIS)	41
0x2A	42	ASTERISK	*	42
0x2B	43	PLUS SIGN	+	43
0x2C	44	COMMA	,	44
0x2D	45	HYPHEN-MINUS	-	45
0x2E	46	FULL STOP	.	46
0x2F	47	SOLIDUS (SLASH)	/	47
0x30	48	DIGIT ZERO	0	48
0x31	49	DIGIT ONE	1	49
0x32	50	DIGIT TWO	2	50
0x33	51	DIGIT THREE	3	51
0x34	52	DIGIT FOUR	4	52
0x35	53	DIGIT FIVE	5	53
0x36	54	DIGIT SIX	6	54
0x37	55	DIGIT SEVEN	7	55
0x38	56	DIGIT EIGHT	8	56

0x39	57	DIGIT NINE	9	57
0x3A	58	COLON	:	58
0x3B	59	SEMICOLON	;	59
0x3C	60	LESS-THAN SIGN	<	60
0x3D	61	EQUALS SIGN	=	61
0x3E	62	GREATER-THAN SIGN	>	62
0x3F	63	QUESTION MARK	?	63
0x40	64	INVERTED EXCLAMATION MARK	¡	161
0x41	65	LATIN CAPITAL LETTER A	A	65
0x42	66	LATIN CAPITAL LETTER B	B	66
0x43	67	LATIN CAPITAL LETTER C	C	67
0x44	68	LATIN CAPITAL LETTER D	D	68
0x45	69	LATIN CAPITAL LETTER E	E	69
0x46	70	LATIN CAPITAL LETTER F	F	70
0x47	71	LATIN CAPITAL LETTER G	G	71
0x48	72	LATIN CAPITAL LETTER H	H	72
0x49	73	LATIN CAPITAL LETTER I	I	73
0x4A	74	LATIN CAPITAL LETTER J	J	74
0x4B	75	LATIN CAPITAL LETTER K	K	75
0x4C	76	LATIN CAPITAL LETTER L	L	76
0x4D	77	LATIN CAPITAL LETTER M	M	77
0x4E	78	LATIN CAPITAL LETTER N	N	78
0x4F	79	LATIN CAPITAL LETTER O	O	79
0x50	80	LATIN CAPITAL LETTER P	P	80
0x51	81	LATIN CAPITAL LETTER Q	Q	81
0x52	82	LATIN CAPITAL LETTER R	R	82
0x53	83	LATIN CAPITAL LETTER S	S	83
0x54	84	LATIN CAPITAL LETTER T	T	84
0x55	85	LATIN CAPITAL LETTER U	U	85
0x56	86	LATIN CAPITAL LETTER V	V	86
0x57	87	LATIN CAPITAL LETTER W	W	87
0x58	88	LATIN CAPITAL LETTER X	X	88
0x59	89	LATIN CAPITAL LETTER Y	Y	89
0x5A	90	LATIN CAPITAL LETTER Z	Z	90
0x5B	91	LATIN CAPITAL LETTER A WITH DIAERESIS	Ä	196
0x5C	92	LATIN CAPITAL LETTER O WITH DIAERESIS	Ö	214
0x5D	93	LATIN CAPITAL LETTER N WITH TILDE	Ñ	209
0x5E	94	LATIN CAPITAL LETTER U WITH DIAERESIS	Ü	220
0x5F	95	SECTION SIGN	§	167
0x60	96	INVERTED QUESTION MARK	¿	191
0x61	97	LATIN SMALL LETTER A	a	97
0x62	98	LATIN SMALL LETTER B	b	98
0x63	99	LATIN SMALL LETTER C	c	99

0x64	100	LATIN SMALL LETTER D	d	100
0x65	101	LATIN SMALL LETTER E	e	101
0x66	102	LATIN SMALL LETTER F	f	102
0x67	103	LATIN SMALL LETTER G	g	103
0x68	104	LATIN SMALL LETTER H	h	104
0x69	105	LATIN SMALL LETTER I	i	105
0x6A	106	LATIN SMALL LETTER J	j	106
0x6B	107	LATIN SMALL LETTER K	k	107
0x6C	108	LATIN SMALL LETTER L	l	108
0x6D	109	LATIN SMALL LETTER M	m	109
0x6E	110	LATIN SMALL LETTER N	n	110
0x6F	111	LATIN SMALL LETTER O	o	111
0x70	112	LATIN SMALL LETTER P	p	112
0x71	113	LATIN SMALL LETTER Q	q	113
0x72	114	LATIN SMALL LETTER R	r	114
0x73	115	LATIN SMALL LETTER S	s	115
0x74	116	LATIN SMALL LETTER T	t	116
0x75	117	LATIN SMALL LETTER U	u	117
0x76	118	LATIN SMALL LETTER V	v	118
0x77	119	LATIN SMALL LETTER W	w	119
0x78	120	LATIN SMALL LETTER X	x	120
0x79	121	LATIN SMALL LETTER Y	y	121
0x7A	122	LATIN SMALL LETTER Z	z	122
0x7B	123	LATIN SMALL LETTER A WITH DIAERESIS	ä	228
0x7C	124	LATIN SMALL LETTER O WITH DIAERESIS	ö	246
0x7D	125	LATIN SMALL LETTER N WITH TILDE	ñ	241
0x7E	126	LATIN SMALL LETTER U WITH DIAERESIS	ü	252
0x7F	127	LATIN SMALL LETTER A WITH GRAVE	à	224

4.2 Troubleshooting

This section of the document describes possible problems encountered when using the Robustel M1000 UP and their solutions.

4.2.1 The modem's LED does not light:

- Check if modem has connected to a proper power supply.
- Check if the power connector is properly inserted.

4.2.2 The modem keep rebooting all the time:

- Please make sure you have inserted the SIM card.

4.2.3 Receiving “No Carrier” Message

If the modem returns a “No Carrier” message upon an attempted call (voice or data), then refer to the table below for possible causes and solutions.

If the modem returns...	Then ask...	Action...
“No Carrier”	Is the received signal strong enough?	Use “AT+CSQ” to check RSSI, please check Signal Strength Indication .
	Is the antenna properly connected?	Refer to section 2.5
“No Carrier” (when trying to issue a voice communication)	Is the semicolon (;) entered immediately after the phone number in the AT command?	Ensure that the semicolon (;) is entered immediately after the phone number in the AT command. e.g. ATD123456;
“No Carrier” (when trying to issue a data communication)	Is the SIM card configured for data / fax calls?	Configure the SIM card for data / fax calls (Ask your network provider if necessary).
	Is the selected bearer type supported by the called party?	Ensure that the selected bearer type is supported by the called party.
	Is the selected bearer type supported by the network?	Ensure that the selected bearer type is supported by the network. If no success, try bearer select type by AT command: AT+CBST=0,0,3

Signal Strength Indication

Value of received signal strength indication (RSSI)	Interpretation of the received signal strength
0 to 12	Insufficient or weak
13 to 19	Average
20 to 31	Good
99	No signal

4.3 Terms and Abbreviations

Abbreviations	Description
AC	Alternating Current
APN	Access Point Name of GPRS Service Provider Network
CE	Conformité Européene (European Conformity)
CHAP	Challenge Handshake Authentication Protocol
CSD	Circuit Switched Data

CTS	Clear to Send
dB	Decibel
dBi	Decibel Relative to an Isotropic radiator
DC	Direct Current
DCD	Data Carrier Detect
DCE	Data Communication Equipment (typically modems)
DCS 1800	Digital Cellular System, also referred to as PCN
DI	Digital Input
DO	Digital Output
DSR	Data Set Ready
DTE	Data Terminal Equipment
DTMF	Dual Tone Multi-frequency
DTR	Data Terminal Ready
EMC	Electromagnetic Compatibility
EMI	Electromagnetic Interference
ESD	Electrostatic Discharges
ETSI	European Telecommunications Standards Institute
GND	Ground
GPRS	General Package Radio Service
GSM	Global Standard for Mobile Communications
IMEI	International Mobile Equipment Identification
kbps	kbits per second
LED	Light Emitting Diode
MAX	Maximum
Min	Minimum
MO	Mobile Originated
MS	Mobile Station
MT	Mobile Terminated
PAP	Password Authentication Protocol
PC	Personal Computer
PCN	Personal Communications Network, also referred to as DCS 1800
PCS	Personal Communication System, also referred to as GSM 1900
PDU	Protocol Data Unit
PPP	Point-to-point Protocol
PIN	Personal Identity Number
PSU	Power Supply Unit
PUK	Personal Unblocking Key
R&TTE	Radio and Telecommunication Terminal Equipment
RF	Radio Frequency
RTC	Real Time Clock
RTS	Request to Send
Rx	Receive Direction
SIM	Subscriber Identification Module

SMA	Subminiature Version A RF Connector
SMS	Short Message Service
TCP/IP	Transmission Control Protocol / Internet Protocol
TE	Terminal Equipment, also referred to as DTE
Tx	Transmit Direction
UART	Universal Asynchronous Receiver-transmitter
USSD	Unstructured Supplementary Service Data
VSWR	Voltage Stationary Wave Ratio