

MD-45 AC
MD-45 LV/HV

WESTERMO[®]

INSTALLATIONSANVISNING
INSTALLATION MANUAL
INSTALLATIONS ANLEITUNG
MANUEL D'INSTALLATION

6157-2003

© Westermo Teleindustri AB

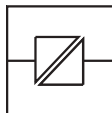

Galvanic
Isolation

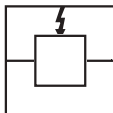

Transient
Protection

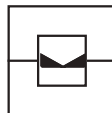

Balanced
Transmission



CE
Approved

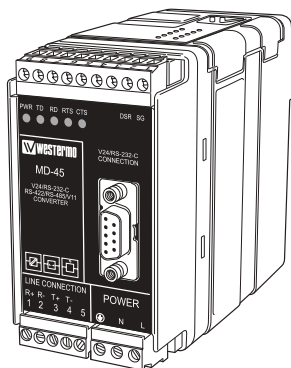

Omvandlare RS-232 – RS-422/485
Converter RS-232 – RS-422/485
RS-232 – RS-422/485 Wandler
Convertisseur RS-232-RS-422/485

WESTERMO[®]

www.westermo.com

Innehåll

1. Introduktion	3
2. Säkerhet	4
3. Godkännanden	4
3.1 Tillverkningsdeklaration	5
4. Specifikationer	6
4.1 Gränssnitt	6
4.2 Isolation mellan gränssnitten	6
4.3 Klimatisk miljö	7
4.4 Mekaniska data	7
5. Underhåll	7
6. Installation	8
6.1 Montering/Demontering	8
6.2 Anslutningar	9
6.2.1 Lysdioder	9
6.2.2 Matning (MD-45 HV,AC)	10
6.2.3 Matning (MD-45 LV)	10
6.2.4 Linjeanslutning (RS-422/485)	10
6.2.5 Terminalanslutning (RS-232, DCE)	10
6.3 Inställning	11
6.3.1 Switchinställningar	11–12
7. Funktionsbeskrivning	13
7.1 Blockdiagram	13
7.2 2 Linjekoppling	14
7.3 Tips	14

1. Introduktion

MD-45 används som gränssnittsomvandlare mellan RS-232C/V.24 och RS-422/485 eller då man är behov av en punkt till punkt kommunikation med hastigheter upp till 115,2 kbit/s. Enheten klarar att kommunicera på 2- eller 4-tråd upp till 1 200 meter och med 32 st laster i bussorienterade applikationer. Vid 2-tråds kommunikation styrs kommunikationsriktningen via dataflödet, dvs omvandlaren känner av data och vänder kommunikationsriktningen beroende från vilken sida data kommer. Det gör det möjligt att ansluta utrustning som ej kan hantera statussignalering. MD-45 är avsedd att monteras på en 35 mm DIN-skena, där man fäster och låser modemmet med ett enkelt handgrepp.

Längre överföringsavstånd eller fler anslutna enheter på bussen klaras med en eller flera repeaters.

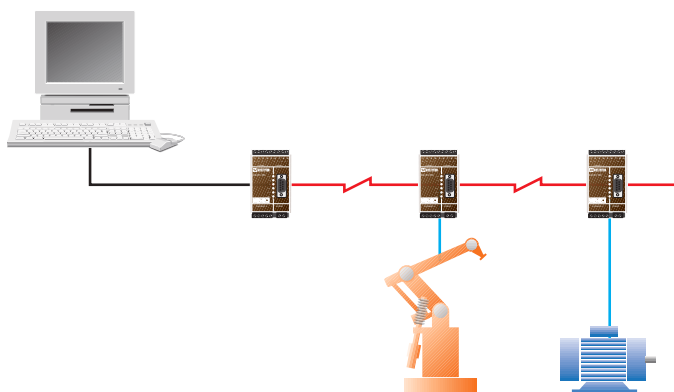

2. Säkerhet



Allmänt:

Innan enheten används, läs denna manual fullständigt och jämför med uppgifter på enheten, samt säkerställ att du har förstått all information. Kontrollera att användandet av enheten i din installation inte kommer att överskrida specificerade säkerhetsprestanda för enheten.



Före installation, reparation, eller modifiering:

Potentialutjämna dig till en jordnings punkt (tex. genom att använda handledsband), så att skada av intern elektronik på grund av elektrostatiska urladdningar (ESD) förhindras.

Koppla ifrån enheten från AC/DC matningsnät samt alla andra elektriska anslutningar, så att åtkomst till farliga spänningar förhindras.



Installation:

Enheten är konstruerad för användning i professionella system. Enheten skall installeras i utrymmen med begränsad åtkomst, tex. låsbart skåp med tillträde endast för service personal.

Enheten är konstruerad för fast anslutning till AC/DC matningsnät och skall installeras av behörig personal.

Enhetens anslutning till matningsnätet skall vara tillräckligt avsäkrat, och om så krävs skall det vara möjligt att manuellt koppla från enheten från matningsnätet. Observera att nationella installations regler skall följas.

Enhet med märkspänning överskridande 42,4V topp eller 60V DC, klassas som skyddsjordad (klass I) utrustning.

Enhet med märkspänning underskridande 42,4V topp eller 60V DC, klassas som klass III utrustning och skall vara separerad från farlig spänning med dubbel eller förstärkt isolation.

Enheten kyls genom konvektion. Följ föreskrivna monterings rekommendationer för att förhindra störningar i kylande luftström kring enheten (se Installation).

3. Godkännanden

Uppfyllande av direktiv 73/23/EEC (låg spänning direktivet) har säkerställt genom tillämpning av standard EN60950.

Uppfyllande av direktiv 89/339/EEC (elektromagnetisk kompatibilitet) har säkerställts genom tillämpning av standard EN61000-6-2 (immunitet) och standard EN61000-6-3 (emission)

3.1 Tillverkardeklaration

Westermo Teleindustri AB

Declaration of conformity

The Westermo Teleindustri AB company declares that the listed products conforms to the Council Directive 89/336/EEC, related to Electro Magnetic Compability and 72/23/EEC Low Voltage Directive.

Type of equipment: DIN-rail converter RS232-RS422/485
Model:

MD-45 AC	3157-0101, 3157-0110
MD-45 HV	3157-1101
MD-45 LV	3157-0001

Standards:

EMC: EN 61000-6-3/CISPR22(EN 55022): Class B
EN 61000-6-2/EN 61000-4-2
EN 61000-6-2/EN 61000-4-3
EN 61000-6-2/EN 61000-4-4
EN 61000-6-2/EN 61000-4-5
EN 61000-6-2/EN 61000-4-6
EN 61000-6-2/EN 61000-4-11
EN 61000-6-2/EN 61000-4-16

Safety: EN 60950

Reference: Installation manual MD-45 AC/HV,LV Art. Nr. 6157-2003



Hans Levin
Technical Manager
May 2003

Postadress/Postal address	Tel.	Telefax	Postgiro	Bankgiro	Org.nr/ Corp. identity number	Stäte/ Registered office
S-640 40 Stora Sundby Sweden	016 - 42 80 00 Int +46 16 42 80 00	016 ¢ 42 80 01 Int +46 16 42 80 01	52 72 79-4	5671-5550	556361-2604	Eskilstuna

4. Specifikationer

4.1 Gränssnitt

Matning

Modellbeteckning	MD-45 AC	MD-45 LV	MD-45 HV
Märkspänning	230 VAC	12–30 VAC 12–48 VDC	95–240 VAC 110–250 VDC
Arbetspänning	207–253 VAC	10–45 VAC 9,6–60 VDC	85,5–264 VAC 88–300 VDC
Märkström	22 mA	300 mA	25 mA @ 240 V, 50 mA @ 95 V
Märkfrekvens	48–62 Hz	48–62 Hz	48–62 Hz
Polaritet	PE, L och N	Oberoende	PE, L och N
Anslutning	3-polig skruvplint	2-polig skruvplint	3-polig skruvplint
Anslutningsarea	0,2 – 2,5 mm ² (AWG 24-12)		
Säkring	Säkras externt		

RS-485/422

Elektrisk specifikation	RS-422/485
Datahastighet	1 200 – 115 200 bit/s
Anslutning	5-polig skruvplint
Anslutningsarea	0,2 – 2,5 mm ² (AWG 24-12)
Kretstyp	TNV-1

RS-232

Elektrisk specifikation	RS-232-C
Datahastighet	1 200 – 115 200 bit/s
Anslutning	9-polig D-sub, DCE
Kretstyp	SELV

4.2 Isolation mellan gränssnitten

Linjespänning (MD-45 HV och AC) till alla andra	3,0 kV RMS @ 50 Hz och 60 s varaktighet
Linjespänning (MD-45 LV) till alla andra	1,0 kV RMS @ 50 Hz och 60 s varaktighet
RS-232 till RS-485/422	1,0 kV RMS @ 50 Hz och 60 s varaktighet

4.3 Klimatisk miljö

Driftstemperatur	5 till 55°C
Temperatur, lagring och transport	-25 till 70°C
Relativ fuktighet, drift	5 till 95% (icke kondenserande)
Relativ fuktighet, lagring och transport	5 till 95% (kondensation på utsidan av förpackningen tillåten)

4.4 Mekaniska data

Dimension (B x H x D)	55 x 100 x 128 mm
Vikt	0,5 kg AC, 0,25 kg HV and LV
Montering	35 mm DIN-skena
Kapsling	IP 20 (IEC 529)

5. Underhåll

Inget krav på underhåll, så länge enheten används på avsett sätt inom specificerade förutsättningar.

6. Installation

6.1 Montering/Demontering

Före montering eller demontering av enheten:

Potentialutjämna dig till en jordnings punkt (tex. genom att använda handledsband), så att skada av intern elektronik på grund av elektrostatiska urladdningar (ESD) förhindras.

Koppla ifrån enheten från AC/DC matningsnät samt alla andra elektriska anslutningar, så att åtkomst till farliga spänningar förhindras.



Montering

Enheter är avsedd att monteras på en 35 mm DIN skena vilken skall vara horisontellt fastsatt, tex. på en vägg eller montageplåt i skåp.

Enheter kyls genom konvektion. För att förhindra störningar i kylande luftström kring enheten krävs ett fritt utrymme på

25 mm ovan/nedan och 10 mm till vänster/höger om enheten.

Snäppfastsättning utan verktyg, se figur.

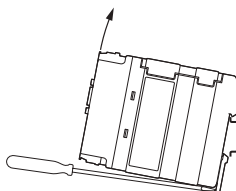
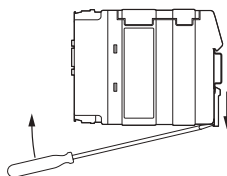
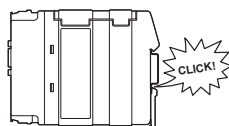
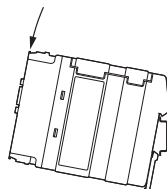
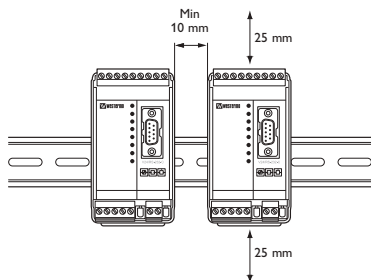

Demontering

Pressa ner den svarta hållaren på enhetens nedre del med hjälp av en skruvmejsel, se figur.

6.2 Anslutningar

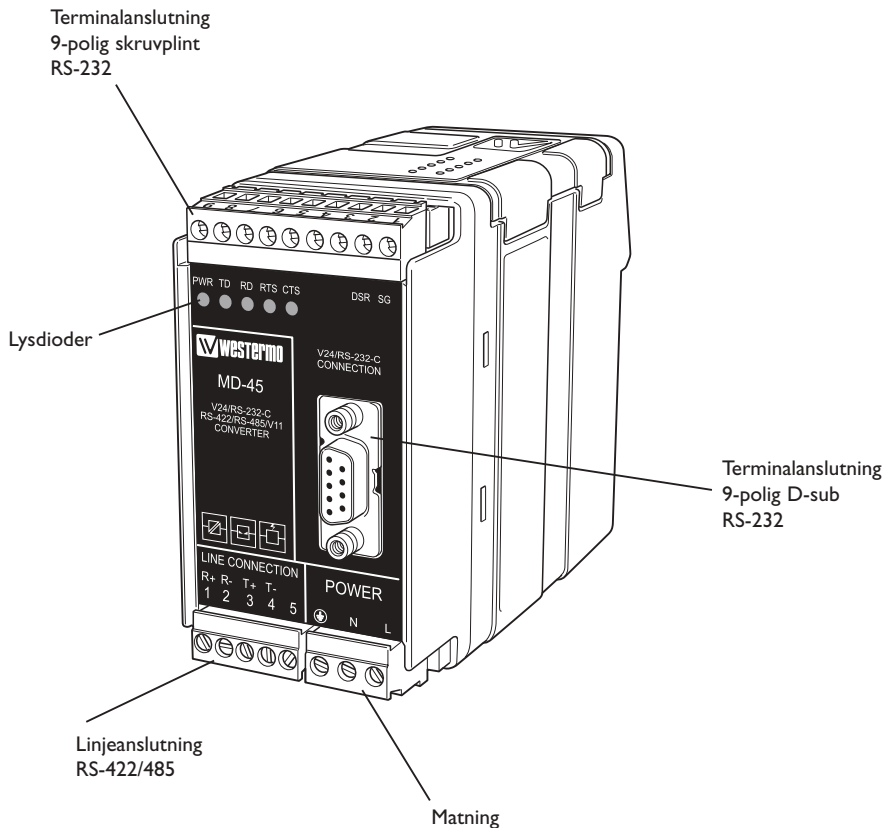

6.2.1 Lysdioder

PWR	Power Indication
RTS	Request To Send modem signal
TD	Transmitted Data: Displays data received from the local RS-232/422/485 port
RD	Received Data: Displays data leaving the modem on the RS-232/422/485 port
CTS	Clear To Send modem signal

6.2.2 Matning (MD-45 HV,AC)

3-polig skruvplint	Beskrivning
L	Linje
N	Neutral
	Skyddsjord



6.2.3 Matning (MD-45 LV)

2-polig skruvplint	Beskrivning
Nr. 1	-Spänning
Nr. 2	+Spänning



6.2.4 Linjeanslutning (RS-422/485)

5-polig skruvplint	Riktning	Beskrivning
Nr. 1	In	A' (R+)
Nr. 2	In	B' (R-)
Nr. 3	In/Out	A (T+)
Nr. 4	In/Out	B (T-)
Nr. 5	-	Skärm



6.2.5 Terminalanslutning (RS-232, DCE)

Skruvplint	9-polig D-sub	Riktning	Beskrivning
7	2	Out	Receive Data (RD)
8	3	In	Transmit Data (TD)
1 & 9	5	-	Signal ground (SG)
2	6	Out	Data set ready (DSR)
6	7	In	Request to send (RTS)
5	8	Out	Clear to send (CTS)

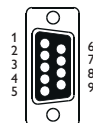

Skruvplint 3 och 4 används ej.

6.3 Inställning

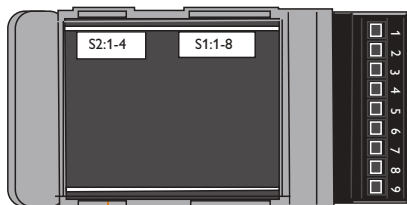

6.3.1 Switchinställningar

DIP-switchar är tillgängliga under locket på toppen av modemet. DIP-switcharna används för att konfigurera enheten.



Varning!

Potentialutjämna dig till en jordnings punkt (tex. genom att använda handledsband), så att skada av intern elektronik på grund av elektrostatiska urladdningar (ESD) förhindras, innan locket på modemets topp tas av.







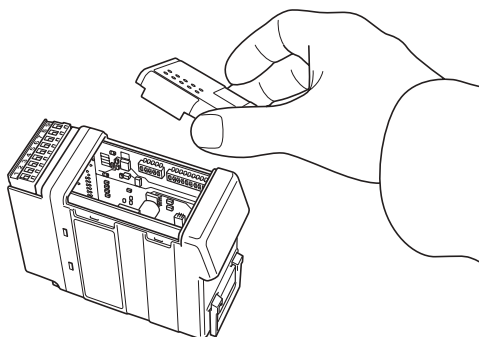



Varning! Öppna ej ansluten enhet.



Koppla ifrån enheten från AC/DC matningsnät samt alla andra elektriska anslutningar, så att åtkomst till farliga spänningar förhindras.





Val av hastighet

	Hastighet	Vändtid
S1 	1 200	780 µs
S1 	2 400	410 µs
S1 	4 800	220 µs
S1 	9 600	130 µs
S1 	19 200	48 µs
S1 	38 400	34 µs
S1 	57 600	22 µs
S1 	115 200	11 µs

Data eller RTS-styrning





S1 	Datstyrning
S1 	RTS-styrning
S1 	Sändare alltid aktiv

Fabriksinställning

S1 
S2 

S1: 8 används ej



Val av antal bitar

S1 	9
S1 	10
S1 	11
S1 	12

2/4-tråds överföring

S1 	2-tråd
S1 	4-tråd

Terminering med fail-safe *

S2 	Terminerad (4-tråd)
S2 	Terminerad (2-tråd)
S2 	Ingen terminering

* Fail-safe funktionen gör att mottagaren alltid uppfattar signaltillståndet OFF då inkopplad sändare har tillståndet tri-state (sändare ej aktiverad). Terminering skall kopplas in på mottagaren belägen längst bort från sändaren.

Hjälptabell för inställning av antal databitar

7 bitar	●	●	●		●			
8 bitar				●		●	●	●
Ingen paritet	●	●		●		●		
Paritet			●		●		●	●
1 stoppbitt	●		●	●			●	
2 stoppbitar		●			●	●		●
Antal bitar	9	10	10	10	11	11	11	12

7.0 Funktionsbeskrivning

När omvandlaren är inställd på datastyrning aktiverar sändaren av att data kommer in på TD (RS-232). Sändaren är sedan aktiv den tid som motsvarar ett tecken plus den så kallade vändtiden för inställd hastighet och antal bitar. Om ytterligare data kommer in innan vändtiden är slut så aktiveras sändaren för ett tecken till. Vid RTS-styrning aktiveras sändaren av RTS-signalen. I detta läge saknar inställningarna för datahastighet och antal tecken betydelse. Lysdioderna styrs enbart av datasignalerna. Den aktiva termineringen säkerställer att mottagarens signalnivå är i läge av (>0,2 Volt) om ingen datatrafik pågår. Full duplex är endast möjlig om RS-422 används.

7.1 Blockdiagram

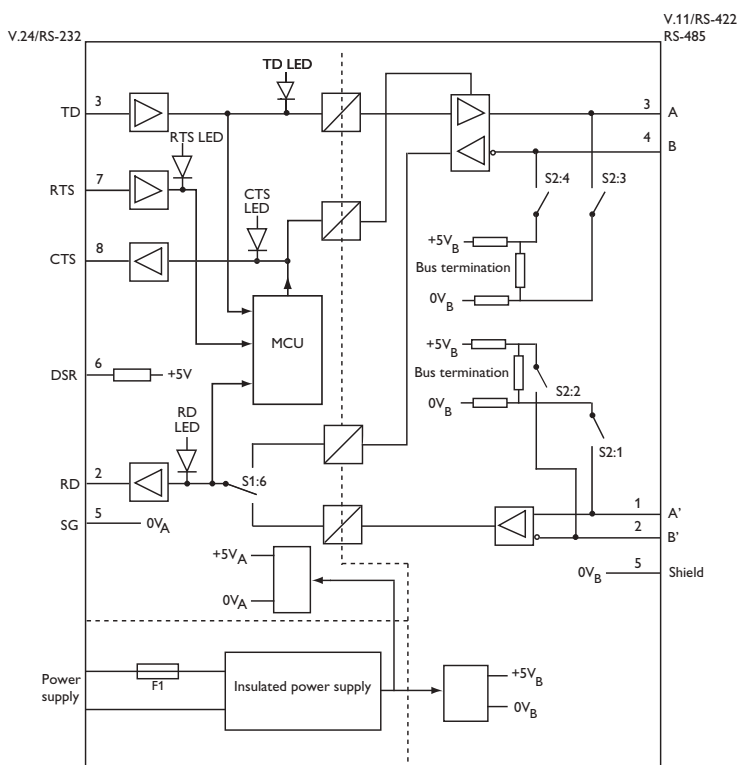

7.2 Linjekoppling

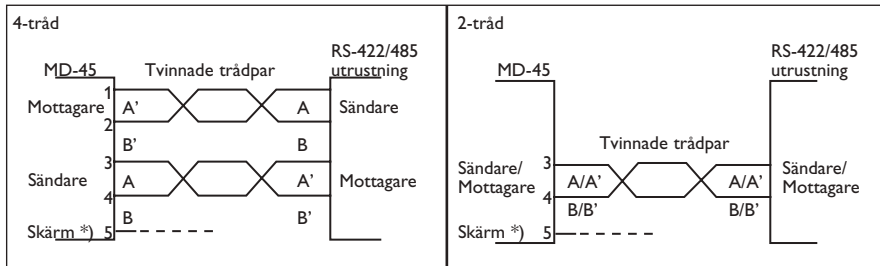

*) Om skärmad kabel används, anslut skärmen endast i en ände för att undvika jordströmmar.

7.3 Tips

RS-422/485 är gränssnitt konstruerade för multidroppapplikationer. Då man kopplar upp en RS-422 alt. RS-485 förbindelse skall man tänka på att installera ett bussnät, d v s det får inte vara förgreningar på kablaget. För att få rätt kabelavlutning skall masteromvandlaren samt den sist anslutna enhetens mottagare termineras.

Nedan visas multidroppinstallation med terminering i RS-485 (2-tråds) och RS-422 (4-tråds) kommunikation.

Om det uppkommer något problem vid inkoppling av MD-45 kan lysdiodsindikeringarna vara till värdefull hjälp vid felsökning.

- PWR: Indikerar att enheten är spänningssatt.
- RD: Indikerar mottagen data på linjesidan.
- CTS: Indikerar samma som RTS.
- RTS: Indikerar RTS signalen från inkopplad utrustning.
- TD: Indikerar mottagen data på RS-232 sidan.

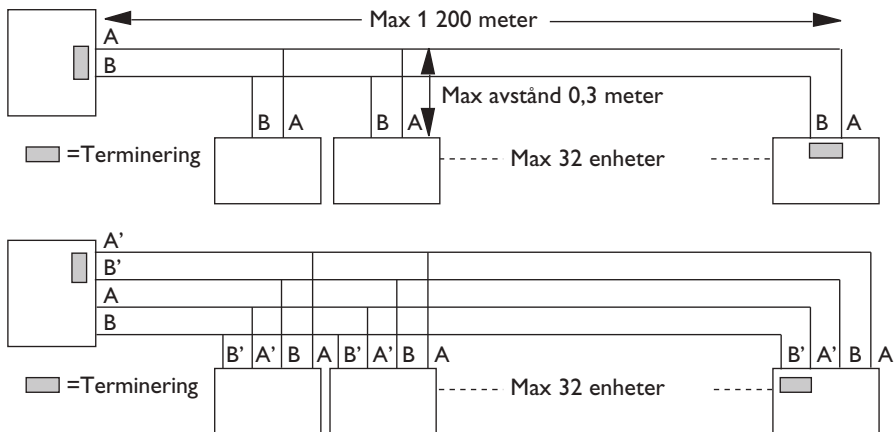

OBS! R+/R-, T+/T- definitionerna är ej standardiserade, det kan hjälpa att skifta A och B om ej enheten fungerar.

Contents

1. Introduction	17
2. Safety	18
3. Approvals	18
3.1 Declaration of conformity	19
4. Specifications	20
4.1 Interfaces	20
4.2 Insulation between interfaces	20
4.3 Climatic environment	21
4.4 Mechanics	21
5. Maintenance	21
6. Installation	22
6.1 Mounting /Removal	22
6.2 Connections	23
6.2.1 LED indicators	23
6.2.2 Power (MD-45 HV,AC)	24
6.2.3 Power (MD-45 LV)	24
6.2.4 Line connection (RS-422/485)	24
6.2.5 Terminal connection (RS-232, DCE)	24
6.3 Configuration	25
6.3.1 DIP switch settings	25–26
7. Functional description	27
7.1 Block diagram	27
7.2 2 Line connection	27
7.3 Hints	28

1. Intruduction

The MD-45 is used to convert between RS-422/485 and RS-232/V.24 signals. This device is often used in multidrop applications connected to a PC or PLC.

In 2-wire half duplex applications (RS-485) the direction of the bus can be controlled by data which means that the converter turns the bus depending on the data sent on the bus. This makes it possible to use the unit with equipment that has no handshaking signals. The maximum transmission rate possible is 115.2 kbit/s.

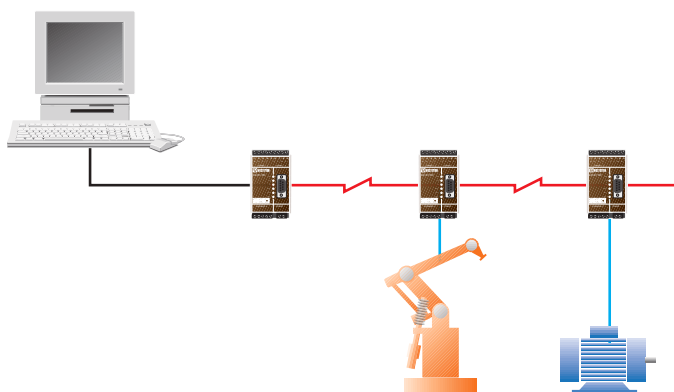

2. Safety



General:

Before using this unit, read this manual completely and gather all information on the unit. Make sure that you understand it fully. Check that your application does not exceed the safe operating specifications for this unit.



Before installation, maintenance or modification work:

Prevent damage to internal electronics from electrostatic discharges (ESD) by discharging your body to a grounding point (e.g. use of wrist strap).

Prevent access to hazardous voltages by disconnecting the unit from AC/DC mains supply and all other electrical connections.



Installation:

This unit should only be installed by qualified personnel.

This unit should only be installed in a “restricted access area”, for example a lockable cabinet where access is restricted to service personnel only.

This unit is intended for permanent connection to the AC/DC mains supply.

The power supply wiring must be sufficiently fused, and if necessary it must be possible to disconnect manually from the AC/DC mains supply. Ensure compliance to national installation regulations.

Unit with the rated voltage exceeding 42.4 V peak or 60 VDC, is defined as class I equipment with a protective earthing conductor terminal.

Unit with the rated voltage up to 42.4 V peak or 60 VDC, is defined as class III equipment and shall be separated from hazardous voltage by double or reinforced insulation.

This unit uses convection cooling. To avoid obstructing the air flow around the unit, follow the spacing recommendations (see under chapter Installation).

3. Approvals

Conformity with the Directive 73/23/EEC (Low Voltage Directive) has been assessed by application of the standard EN 60 950.

Conformity with the Directive 89/339/EEC (Electromagnetic compatibility) has been assessed by application of standards EN 61000-6-2 (industrial immunity) and EN 61000-6-3 (residential emission).

3.1 Declaration of conformity

Westermo Teleindustri AB

Declaration of conformity

The Westermo Teleindustri AB company declares that the listed products conforms to the Council Directive 89/336/EEC, related to Electro Magnetic Compability and 72/23/EEC Low Voltage Directive.

Type of equipment: DIN-rail converter RS232-RS422/485
Model: MD-45 AC 3157-0101, 3157-0110
MD-45 HV 3157-1101
MD-45 LV 3157-0001

Standards:

EMC: EN 61000-6-3/CISPR22(EN 55022): Class B
EN 61000-6-2/EN 61000-4-2
EN 61000-6-2/EN 61000-4-3
EN 61000-6-2/EN 61000-4-4
EN 61000-6-2/EN 61000-4-5
EN 61000-6-2/EN 61000-4-6
EN 61000-6-2/EN 61000-4-11
EN 61000-6-2/EN 61000-4-16
Safety: EN 60950

Reference: Installation manual MD-45 AC/HV,LV Art. Nr. 6157-2003



Hans Levin
Technical Manager
May 2003

Postaddress/Postal address	Tel.	Telefax	Postgiro	Bankgiro	Org.nr/ Corp. identity number	Stäte/ Registered office
S-640 40 Stora Sundryb Sweden	016 - 42 80 00 Int +46 16 42 80 00	016 ñ 42 80 01 Int +46 16 42 80 01	52 72 79-4	5671-5550	556361-2604	Eskilstuna

4. Specifications

4.1 Interfaces

Power

Model description	MD-45 AC	MD-45 LV	MD-45 HV
Rated voltage	230 VAC	12–30 VAC 12–48 VDC	95–240 VAC 110–250 VDC
Operating voltage	207–253 VAC	10–45 VAC 9,6–60 VDC	85.5–264 VAC 88–300 VDC
Rated current	22 mA	300 mA	25 mA @ 240 V, 50 mA @ 95 V
Rated frequency	48–62 Hz	48–62 Hz	48–62 Hz
Polarity	PE, L and N	Independent	PE, L and N
Connection	3-pos screw block	2-pos screw block	3-pos screw block
Connector size	0.2 – 2.5 mm ² (AWG 24-12)		
Fuse	To be externally fused		

RS-485/422

Electrical specification	RS-422/485
Data rate	1 200 – 115 200 bit/s
Connection	5-pos screw block
Connector size	0.2 – 2.5 mm ² (AWG 24-12)
Circuit type	TNV-1

RS-232

Electrical specification	RS-232-C
Data rate	1 200 – 115 200 bit/s
Connection	9-pos D-sub, DCE
Circuit type	SELV

4.2 Insulation between interfaces

Power

(MD-45 HV and AC)

to all other 3.0 kV RMS @ 50 Hz and 60 s duration

Power

(MD-45 LV)

to all other 1.0 kV RMS @ 50 Hz and 60 s duration

RS-232 to RS-485/422 1.0 kV RMS @ 50 Hz and 60 s duration

4.3 Climatic environment

Temperature, operating	5 to 55°C
Temperature, storage and transportation	-25 to 70°C
Relative humidity, operating	5 to 95% (non-condensing)
Relative humidity, storage and transportation	5 to 95% (condensation allowed outside packaging)

4.4 Mechanics

Dimension (W x H x D)	55 x 100 x 128 mm
Weight	0.5 kg AC, 0.25 kg HV and LV
Mounting	35 mm DIN-rail
Degree of protection	IP 20 (IEC 529)

5. Maintenance

No maintenance is required, as long as the unit is used as intended within the specified conditions.

6. Installation

6.1 Mounting /Removal



Before mounting or removing the unit:

Prevent damage to internal electronics from electrostatic discharges (ESD) by discharging your body to a grounding point (e.g. use of wrist strap).

Prevent access to hazardous voltages by disconnecting the unit from AC/DC mains supply and all other electrical connections.

Mounting

This unit should be mounted on 35 mm DIN-rail which is horizontally mounted on a wall or cabinet backplate.

This unit uses convection cooling. To avoid obstructing the air flow around the unit, use the following spacing rules. Minimum spacing 25 mm (1.0 inch) above/below and 10 mm (0.4 inches) left/right the unit.

Snap on mounting, see figure.

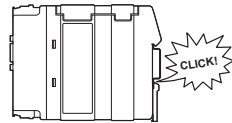
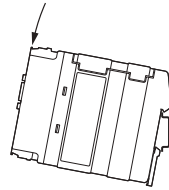
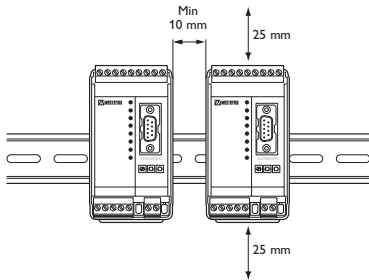

Removal

Press down the black support at the back of the unit using a screwdriver, see figure.

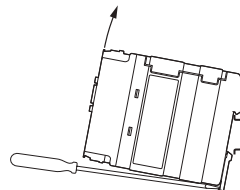
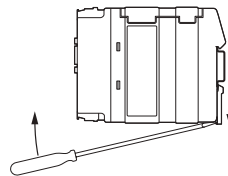

6.2 Connections

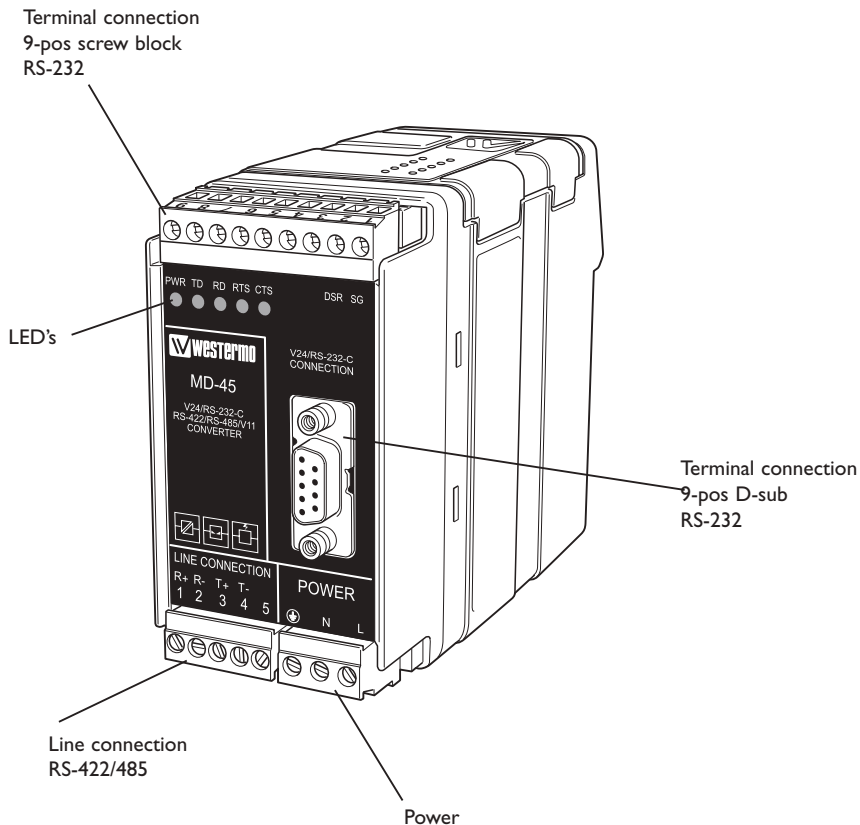

6.2.1 LED indicators

PWR	Power Indication
RTS	Request To Send modem signal
TD	Transmitted Data: Displays data received from the local RS-232/422/485 port
RD	Received Data: Displays data leaving the modem on the RS-232/422/485 port
CTS	Clear To Send modem signal

6.2.2 Power (MD-45 HV, AC)

3-pos screw terminal	Description
L	Line
N	Neutral
	Protective earth



6.2.3 Power (MD-45 LV)

2-position screw terminal	Description
No. 1	-Voltage
No. 2	+Voltage



6.2.4 Line connection (RS-422/485)

5-position screw terminal	Direction	Description
No. 1	In	A' (R+)
No. 2	In	B' (R-)
No. 3	In/Out	A (T+)
No. 4	In/Out	B (T-)
No. 5	-	Shield



6.2.5 Terminal connection (RS-232, DCE)



Screw terminal	9-pos D-sub	Direction	Description
7	2	Out	Receive Data (RD)
8	3	In	Transmit Data (TD)
1 & 9	5	-	Signal ground (SG)
2	6	Out	Data set ready (DSR)
6	7	In	Request to send (RTS)
5	8	Out	Clear to send (CTS)

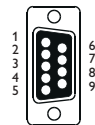

Screw terminal 3 and 4 not used

6.3 Configuration

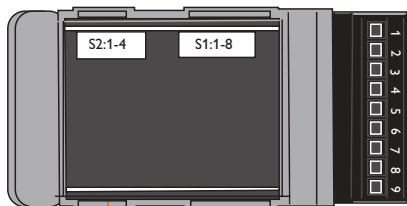

6.3.1 DIP-switch settings

DIP-switches are accessible under the lid on top of the unit. DIP-switches are used to configure the modem.



Warning!

Prevent damage to internal electronics from electrostatic discharges (ESD) by discharging your body to a grounding point (e.g. use of wrist strap), before the lid on top of the modem is removed.







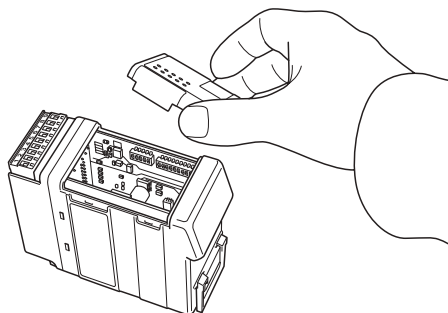



Warning! Do not open connected equipment.





Prevent access to hazardous voltages by disconnecting the unit from AC/DC mains supply and all other electrical connections.



Selection of data rate

	Data rate	Turning time
S1 	1 200	780 μ s
S1 	2 400	410 μ s
S1 	4 800	220 μ s
S1 	9 600	130 μ s
S1 	19 200	48 μ s
S1 	38 400	34 μ s
S1 	57 600	22 μ s
S1 	115 200	11 μ s



Selection of bits

S1 	9
S1 	10
S1 	11
S1 	12



2/4-wire transmission

S1 	2-wire
S1 	4-wire

Data or RTS-control



S1 	Data control
S1 	RTS-control
S1 	Transmitter always active

Termination with fail-safe *

S2 	Terminated (4-wire)
S2 	Terminated (2-wire)
S2 	No termination

* The fail-safe function forces the signal state of the receiver to OFF when the connected transmitter is in tri-state (transmitter inactive). The receiver located furthest away shall be terminated.

Factory settings

S1 
S2 

S1: 8 not used

Supervision table when selecting data bits

7 bits	●	●	●		●			
8 bits				●		●	●	●
No parity	●	●		●		●		
Parity			●		●		●	●
1 stop bit	●		●	●			●	
2 stop bits		●			●	●		●
Number of bits	9	10	10	10	11	11	11	12

7.0 Functional description

When the converter is set to data-control mode the transmitter is activated by data on TD (RS-232). The time the transmitter stays active corresponds to one character-time and turning time for the set data rate and number of bits. If there is more data on TD before the turning time is ended the transmitter stays active for additional one character. In RTS-control mode the transmitter is activated by the RTS-signal. In this mode the switches for data rate and number of bits has no effect. The LED indicators is controlled by the data signals. The active termination secures that the signal level at the receiver is in off-state (>0.2 Volts) when there is no data transmission. Full duplex is only possible if RS-422 is used.

7.1 Block diagram

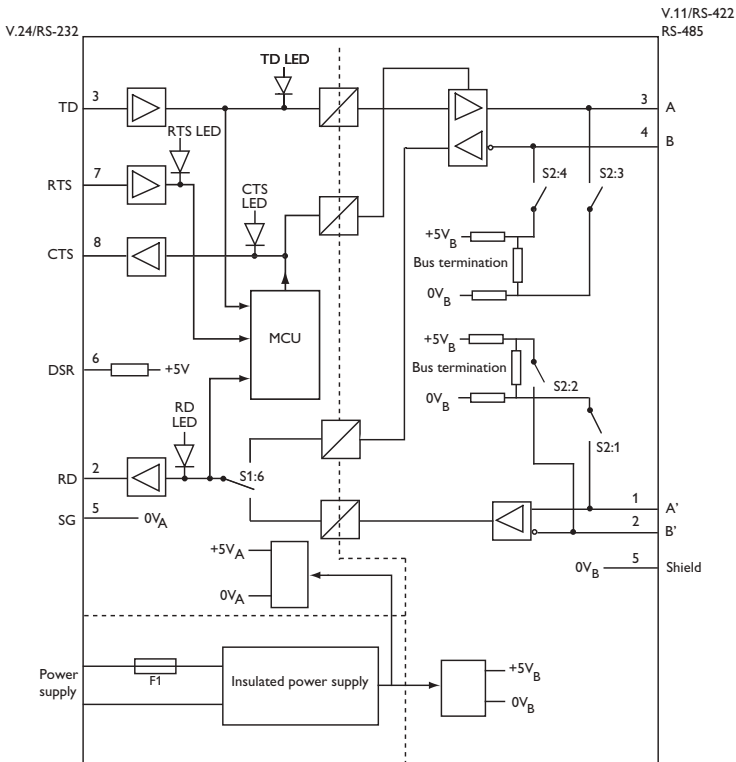

7.2 Line connection

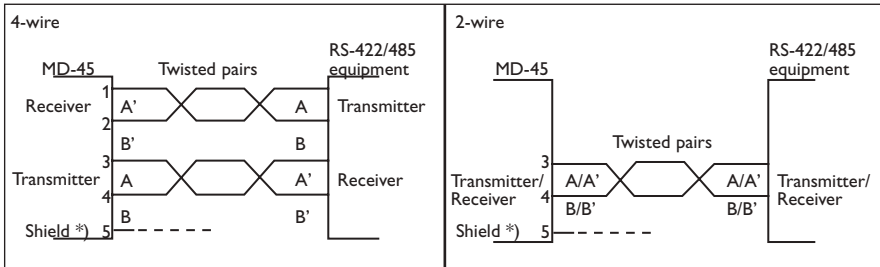

**) If shielded cable is used, connect the shield only at one end to avoid ground currents.*

7.3 Hints

RS-422/485 was designed for multidrop applications. When a system is installed it should form a bus structure (see diagrams). Star shaped networks should never be created, there are other Westermo products designed to work in star net applications. To get a correct installation according to the RS-422/485 specification it's very important that the line is terminated at the correct points. The recommendation is to terminate the receiver on the master unit and the final bus slave unit. See diagrams for details of how this is done with RS-485 (2-wire) and RS-422 (4-wire).

The line transmitter used in the MD-45 is activated by data received on the RS-232 interface, unlike conventional converters that rely on a control signal (e.g. RTS).

If any problems do occur on set up of the MD-45, the LED's will be helpful.

- PWR: The unit has power.
- RD: Data received on the RS-422/485 interface.
- CTS: Follows RTS.
- RTS: Status of RTS from the RS-232 interface.
- TD: Data received on RS-232 interface.

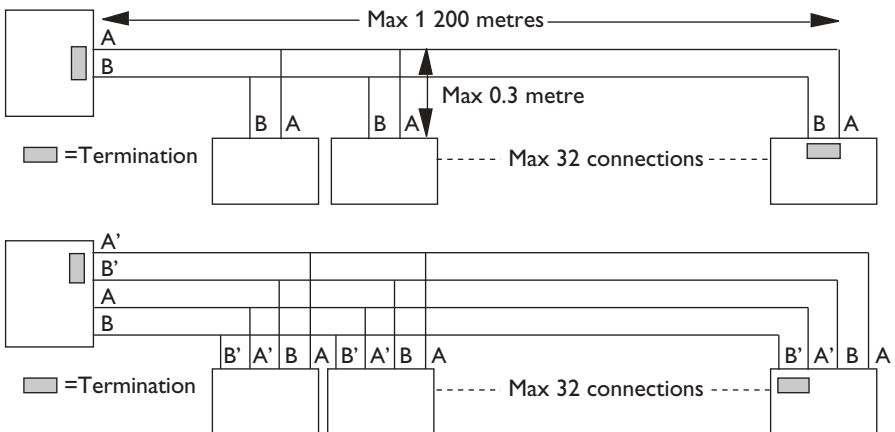

N.B. R+/R-, T+/T- definitions are not standard, it can help to shift A and B if the unit does not work.

Inhalt

1. Einleitung	31
2. Sicherheitshinweise	32
3. Zulassungen	32
3.1 Konformitätserklärung (Declaration of conformity)	33
4. Technische Daten	34–35
4.1 Schnittstellen	34
4.2 Isolation zwischen Schnittstellen	34
4.3 Umgebungsbedingungen	35
4.4 Mechanische Daten	35
5. Wartung	35
6. Installation	36
6.1 Installation/Deinstallation	36
6.2 Anschlüsse	37–38
6.2.1 LED Anzeigen	37
6.2.2 Spannungsversorgung (MD-45 HV,AC)	38
6.2.3 Spannungsversorgung (MD-45 LV)	38
6.2.4 Leitungsanschluss (RS-422/485)	38
6.2.5 Terminalanschluss (RS-232, DCE)	38
6.3 Konfiguration	39
6.3.1 DIP-Schalter Einstellung	39–40
7. Funktionsbeschreibung	41–42
7.1 Blockschaltbild	41
7.2 Leitungsanschluss	42
7.3 Tips	42

1. Einleitung

Das MD-45 wird zur Wandlung zwischen RS-422/485 und RS-232/V.24 Schnittstellen eingesetzt. MD-45 wird oftmals in multidrop Applikationen für PC und SPS Anwendungen eingesetzt.

Bei RS-485 2-Draht Halbduplex Applikationen kann die Datenrichtung über die Daten selber gesteuert werden, dies bedeutet das der Bus anhand der darauf vorhandenen Daten gesteuert wird. Dadurch ist es möglich, MD-45 mit Geräten ohne Handshakesignale zu betreiben. Die maximale Übertragungsgeschwindigkeit ist 115,2Kbit/s.

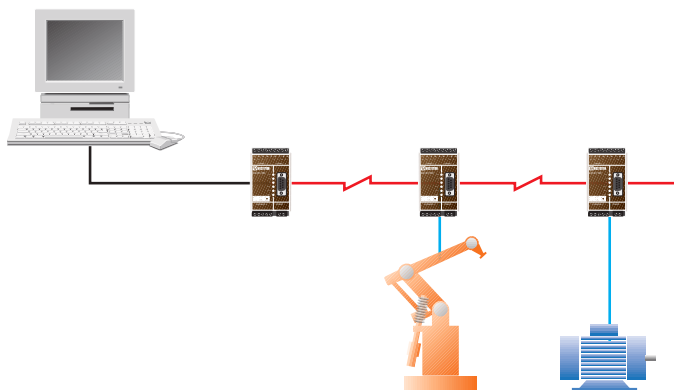

2. Sicherheitshinweise



Allgemeines:

Vor dem Einsatz des Gerätes ist die Bedienungsanleitung vollständig zu lesen. Überprüfen Sie, dass der Einsatz dieser Geräte keine Vorschriften verletzt, und den Spezifikationen des Geräts entspricht.



Vor der Installation, Wartung oder Modifikation:

Vermeiden Sie Schaden an der Elektronik durch elektrostatische Aufladung (ESD) indem Sie sich vorher an einem Erdpunkt entladen (z.B. Einsatz eines Erdarmbandes).

Vermeiden Sie durch Abziehen der Spannungsversorgung, dass stromführende Teile berührt werden können.



Installation:

Es sollte nur in einem gesicherten Umfeld betrieben werden, zu dem nur Servicepersonal Zutritt hat.

Die Einheit ist zum permanenten Anschluss an AC/DC Spannungsversorgungen gedacht und darf nur von geeignetem Personal installiert werden.

Die AC/DC Versorgungsleitungen sind ausreichend abzusichern, und eine manuelle Unterbrechungsmöglichkeit ist bei Bedarf vorzusehen. Beachten Sie auch die nationalen Vorschriften zu diesem Thema.

Ein Gerät welches mit mehr als 42.4V Spitze oder 60V DC arbeitet, ist als Class I Gerät mit Schutzterde Anschluss ausgewiesen.

Ein Gerät welches mit weniger als 42.4V Spitze oder 60V DC arbeitet, ist als Class III Gerät ausgewiesen, und sollte gegenüber Hochspannungen, durch verdoppelte oder externe Isolationen, separiert werden.

Zur Kühlung des Gerätes wird die Außenluft benutzt, daher sollte die Luftströmung um das Gerät nicht gestört sein. Siehe Installationshinweise.

3. Zulassungen

Die Konformität zur Direktive 73/23/EEC (Niederspannungs Richtlinien) wurde durch das Einbinden des Standards EN60950 erzielt.

Die Konformität mit der Richtlinie 89/339/EEC (Elektromagnetische Kompatibilität) wurde durch Einbinden des Applikationsstandards EN 61000-6-2 (industrielle Beeinflussung) und EN 61000-6-3 (industrielle Austrahlung) erzielt.

3.1 Konformitätserklärung

Westermo Teleindustri AB

Declaration of conformity

The Westermo Teleindustri AB company declares that the listed products conforms to the Council Directive 89/336/EEC, related to Electro Magnetic Compability and 72/23/EEC Low Voltage Directive.

Type of equipment: DIN-rail converter RS232-RS422/485
Model: MD-45 AC 3157-0101, 3157-0110
MD-45 HV 3157-1101
MD-45 LV 3157-0001

Standards:

EMC: EN 61000-6-3/CISPR22(EN 55022): Class B
EN 61000-6-2/EN 61000-4-2
EN 61000-6-2/EN 61000-4-3
EN 61000-6-2/EN 61000-4-4
EN 61000-6-2/EN 61000-4-5
EN 61000-6-2/EN 61000-4-6
EN 61000-6-2/EN 61000-4-11
EN 61000-6-2/EN 61000-4-16
Safety: EN 60950

Reference: Installation manual MD-45 AC/HV,LV Art. Nr. 6157-2003



Hans Levin
Technical Manager
May 2003

Postadress/Postal address	Tel.	Telefax	Postgiro	Bankgiro	Org.nr/ Corp. identity number	Säte/ Registered office
S-640 40 Stora Sundby Sweden	016 - 42 80 00 Int +46 16 42 80 00	016 11 42 80 01 Int +46 16 42 80 01	52 72 79-4	5671-5550	556361-2604	Eskilstuna

4. Technische Daten

4.1 Schnittstellen

Spannungsversorgung

Modelbeschreibung	MD-45 AC	MD-45 LV	MD-45 HV
Eingangsspannung	230 VAC	12–30 VAC 12–48 VDC	95–240 VAC 110–250 VDC
Betriebsspannung	207–253 VAC	10–45 VAC 9,6–60 VDC	85,5–264 VAC 88–300 VDC
Stromaufnahme	22 mA	300 mA	25 mA @ 240 V, 50 mA @ 95 V
Frequenz	48–62 Hz	48–62 Hz	48–62 Hz
Polarität	PE, L und N	Unabhängig	PE, L und N
Anschluss	3-pol. Schraubklemme	2-pol. Schraubklemme	3-pol. Schraubklemme
Anschlussgröße	0,2 – 2,5 mm ² (AWG 24-12)		
Sicherung	Muss extern abgesichert werden		

RS-485/422

Elektrische Daten	RS-422/485
Übertragungsrate	1 200 – 115 200 Bit/s
Anschluss	9-pol. Sub-D Buchse, DCE
Anschlussgröße	0,2 – 2,5 mm ² (AWG 24-12)
Anschlusstyp	TNV-1

RS-232

Elektrische Daten	RS-232-C
Übertragungsrate	1 200 – 115 200 Bit/s
Anschluss	9-pol. Sub-D Buchse, DCE
Anschlusstyp	SELV

4.2 Isolation zwischen Schnittstellen

Spannung (MD-45 HV und AC) zu allen	3,0 kV RMS @ 50 Hz und 60 s Dauer
Spannung (MD-45 LV) zu allen	1,0 kV RMS @ 50 Hz und 60 s Dauer
RS-232 zu RS-422/485	1,0 kV RMS @ 50 Hz und 60 s Dauer

4.3 Klimatische Bedingungen

Betriebstemperatur	5 bis 55°C
Lager- und Transporttemperatur	-25 bis 70°C
Relative Luftfeuchtigkeit, Betrieb	5 bis 95% nicht kondensierend
Relative Luftfeuchtigkeit, Lager- und Transport	5 bis 95% kondensierend außerhalb Verpackung

4.4 Mechanisch

Abmessungen (BxHxT)	55 x 100 x 128 mm
Gewicht	0,5 kg AC, 0,25 kg HV und LV
Montage	35 mm DIN-Hutschiene
Schutzklasse	IP 20 (IEC 529)

5. Wartung

Es sind keine Wartungsarbeiten notwendig, solange das Gerät innerhalb seiner Spezifikation eingesetzt wird.

6. Installation

6.1 Montage/Demontage



Vor der Montage oder Demontage des Geräts:

Vermeiden Sie Schaden an der Elektronik durch elektrostatische Aufladung (ESD) indem Sie sich vorher an einem Erdpunkt entladen (z.B. Einsatz eines Erdarmbandes).

Um ein Berühren spannungsführender Teile zu vermeiden, ist das Gerät vor der Montage/Demontage von allen Spannungsführenden Teilen abzuklemmen.

Montage

Das Gerät ist für die Montage auf einer horizontalen 35 mm Hutschiene vorgesehen. Zur Kühlung des Gerätes müssen bestimmte Mindestabstände eingehalten werden. Über und unter dem Gerät min. 25mm (1.0 Inch) und links und rechts min. 10 mm (0.4 Inches).

Aufschnapp Montage (Skizze).

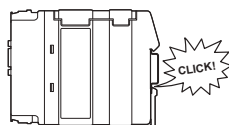
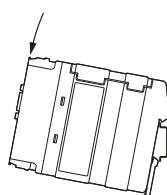
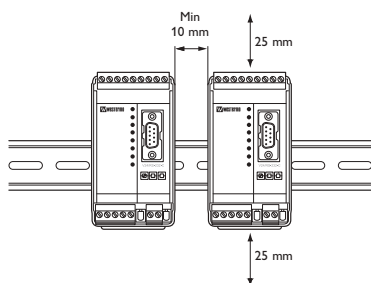

Demontage

Die schwarze Halterung auf der Unterseite mit einem Schraubendreher nach unten ziehen und das Gerät nach oben von der Hutschiene nehmen (Skizze).

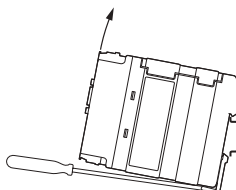
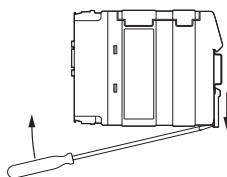

6.2 Anschlüsse

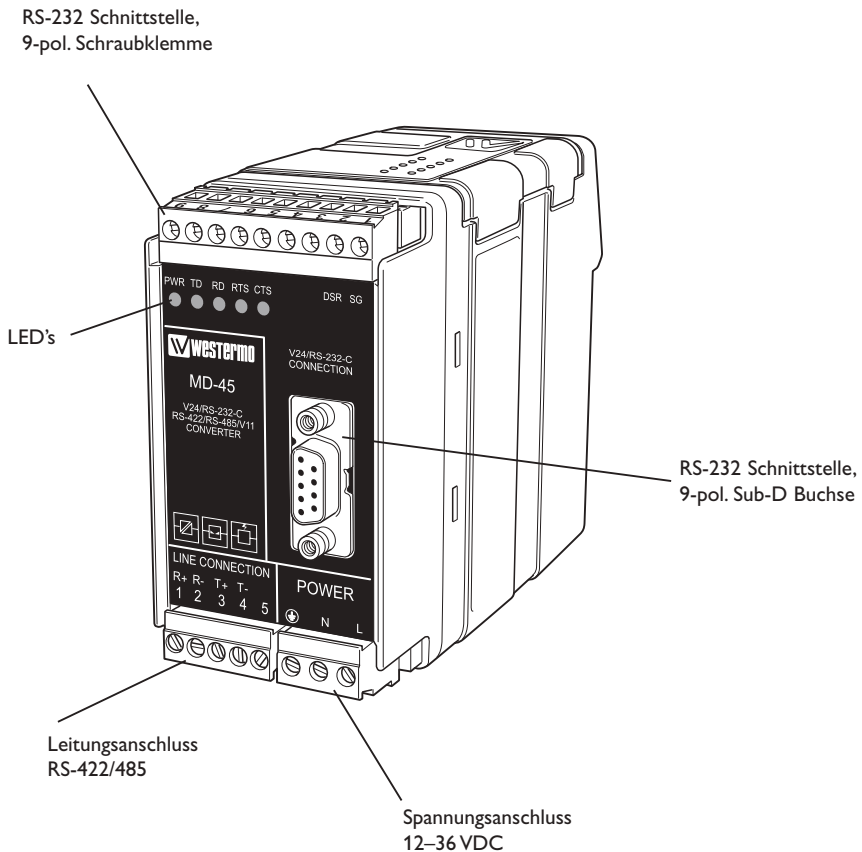

6.2.1 LED Anzeigen

PWR	Spannungsversorgung
TD	LED zeigt empfangene Daten an der lokalen RS-232/422/485 Schnittstelle an
RD	LED zeigt gesendete Daten an der lokalen RS-232/422/485 Schnittstelle an
RTS	Request to Send Signal des Modems
CTS	Clear to Send Signal des Modems

6.2.2 Spannungsversorgung (MD-45 HV, AC)

3-pol. Schraubklemme	Beschreibung
L	Phase
N	Neutralleiter
	Schutzerde



6.2.3 Spannungsversorgung (MD-45 LV)

Schraubklemme	Beschreibung
Nr. 1	-Spannung
Nr. 2	+Spannung



6.2.4 Leitungsschnittstelle (RS-422/485)

5-pol. Schraubklemme	Richtung	Beschreibung
Nr. 1	In	A' (R+)
Nr. 2	In	B' (R-)
Nr. 3	In/Out	A (T+)
Nr. 4	In/Out	B (T-)
Nr. 5	-	Schirmung



6.2.5 Terminalanschluss RS-232, DCE



Schraubklemme	9-pol. Sub-D	Richtung	Beschreibung
7	2	Out	Receive Data (RD)
8	3	In	Transmit Data (TD)
1 & 9	5	-	Signal ground (SG)
2	6	Out	Data set ready (DSR)
6	7	In	Request to send (RTS)
5	8	Out	Clear to send (CTS)

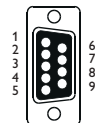

Schraubklemme Nr. 3 und 4 nicht benutzt

6.3 Konfiguration

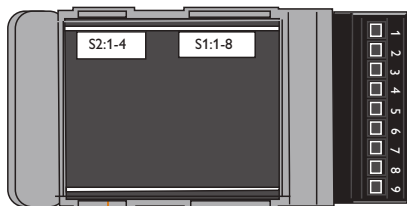

6.3.1 DIP-Schalter Einstellung

Die DIP-Schalter sind über die obere Abdeckung zugänglich. Über die DIP-Schalter kann das Gerät konfiguriert werden.



WARNUNG!

Vermeiden Sie Schaden an der Elektronik durch elektrostatische Aufladung (ESD) indem Sie sich vorher an einem Erdpunkt entladen (z.B. Einsatz eines Erdarmbandes), bevor sie den Deckel abnehmen.







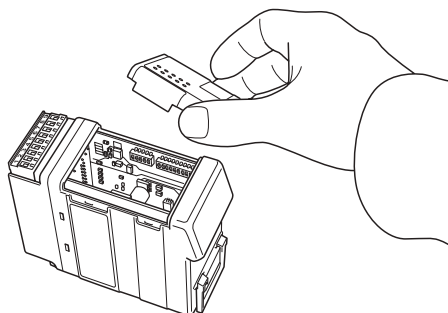



WARNUNG! Keine angeschlossenen Geräte öffnen.



Um ein Berühren spannungsführender Teile zu vermeiden, ist das Gerät vor der Montage/Demontage von allen Spannungsführenden Teilen abzuklemmen.





Einstellung der Übertragungsrate

	Übertragungsrate	Umschaltzeit
S1 	1 200	780 µs
S1 	2 400	410 µs
S1 	4 800	220 µs
S1 	9 600	130 µs
S1 	19 200	48 µs
S1 	38 400	34 µs
S1 	57 600	22 µs
S1 	115 200	11 µs

Daten oder RTS-Steuerung





S1 	Datenfluss
S1 	RTS-Steuerung
S1 	Sender immer aktiv

Werkseinstellung



S1 
S2 

S1:8 nicht benutzt



Anzahl der Bits

S1 	9
S1 	10
S1 	11
S1 	12

2/4-Draht Übertragung

S1 	2-Draht
S1 	4-Draht

Termination mit Fail-Safe *

S2 	Termination (4-Draht)
S2 	Termination (2-Draht)
S2 	Keine Termination

* Die Fail-Safe Funktion zwingt den Empfänger in den AUS Zustand, wenn der angeschlossene Sender sich im Tri-State (Sender inaktiv) befindet. Am weitest entfernten Empfänger sollte die Termination gesetzt sein.

Übersichtstabelle für Datenlänge

7 Bits	●	●	●		●			
8 Bits				●		●	●	●
Keine Parität	●	●		●		●		
Parität			●		●		●	●
1 Stop Bit	●		●	●			●	
2 Stop Bit		●			●	●		●
Anzahl der Bits	9	10	10	10	11	11	11	12

7.0 Funktionsbeschreibung

Ist der Wandler auf automatische Datensteuerung eingestellt, wird der Sender bei ankommenden Daten am TD (RS-232) Eingang aktiviert. Die Zeit, die der Sender aktiv bleibt, hängt von den Einstellungen für Umschaltzeit, Datenrate und Anzahl der Bits ab. Werden an TD weitere Daten gesendet bevor die Umschaltzeit beendet ist, bleibt dieser für eine weitere Zeichenzeit aktiv.

Im RTS gesteuerten Modus wird der Sender durch das RTS Signal aktiviert. Hier sind die Schalter für Datenrate und Anzahl der Bits inaktiv. Die LED's werden direkt von den Datensignalen angesteuert. Eine aktivierte Termination setzt den Empfänger in AUS Status ($>0,2V$) wenn keine Daten gesendet werden. Vollduplex ist nur bei RS-422 möglich.

7.1 Blockdiagramm

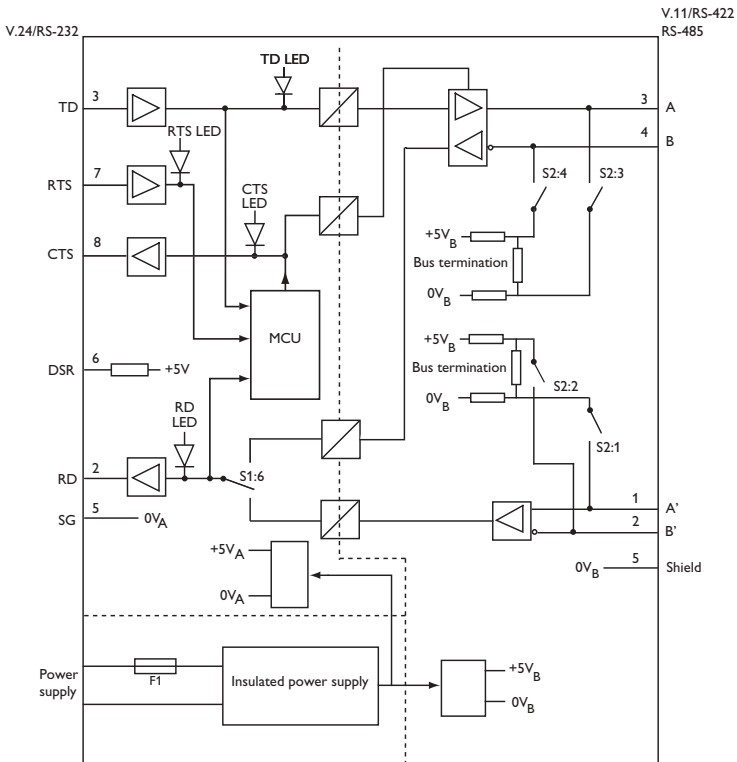

7.2 Leitungsanschluß

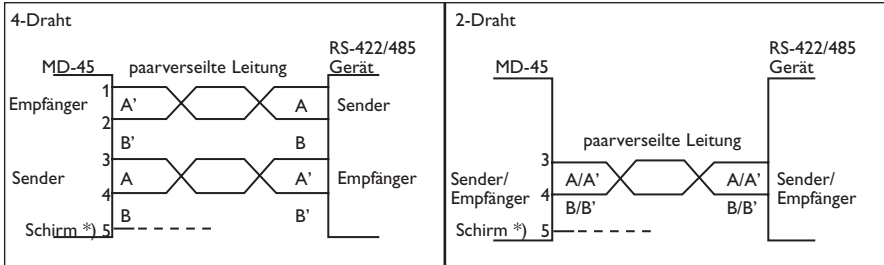

*) Bei Verwendung von abgeschirmten Kabeln den Schirm nur auf einer Seite anschließen um Erdströme zu vermeiden

7.3 Tips

Der Schnittstellenstandard RS-422/485 wurde für Mehrpunktverbindungen entwickelt. Dieser Standard ist für Busnetze (siehe Beispiele) geeignet. Sternnetze sollten vermieden werden. Für eine korrekte Installation eines RS-422/485 sollte an den richtigen Punkten die Termination eingeschaltet werden. Es sollte am Empfänger des Masters und am letzten Slave die Termination eingeschaltet werden. Siehe Beispiele für RS-485 (2-Draht) und RS-422 (4-Draht) Termination.

Der Sender des MD-45 wird aktiviert sobald Daten an der RS-232 Schnittstelle empfangen werden, nicht wie normale Konverter die ein Kontrollsignal z.B. RTS benötigen.

Bei Problemen mit der Einstellung des MD-42 können die LED's hilfreich sein:

- PWR Das Gerät hat Versorgungsspannung
- RD Daten Empfang an der RS-422/485 Schnittstelle
- CTS folgt RTS.
- RTS zeigt den Status der RS-232 Schnittstelle an.
- TD Daten Empfang an der RS-232 Schnittstelle

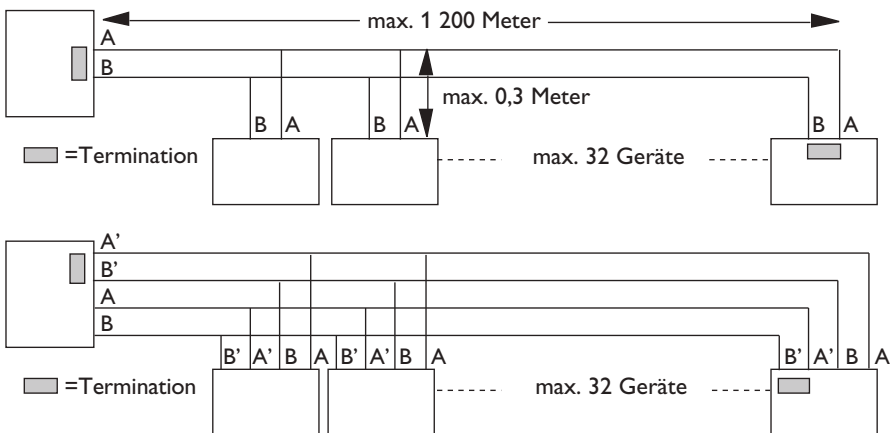

Hinweis: Die Bezeichnungen R+/R-, T+/T- sind nicht Standard, es kann bei Problemen helfen, A und B zu tauschen.

Tables des matières

1. Introduction	45
2. Sécurité	46
3. Homologation	46
3.1 Déclaration de conformité	47
4. Spécifications	48
4.1 Interfaces	48
4.2 Isolation entre interfaces	48
4.3 Environnement climatique	49
4.4 Mécanique	49
5. Maintenance	49
6. Installation	50
6.1 Fixation/Démontage	50
6.2 Connexions	51
6.2.1 Indicateurs de statut LED	51
6.2.2 Alimentation (MD-45 HV,AC)	52
6.2.3 Alimentation (MD-45 LV)	52
6.2.4 Connexion ligne (RS-422/485)	52
6.2.5 Connexion terminal (RS-232 DCE)	52
6.3 Configuration	53
6.3.1 Configuration interrupteurs DIP	53-54
7. Description fonctionnelle	55
7.1 Diagramme simplifié	55
7.2 2 Connexion ligne	56
7.3 Conseils pratiques	56

1. Introduction

Le MD-45 a été conçu pour convertir les signaux entre une interface RS-232/V.24 et une interface RS-422/485. Cet équipement est souvent utilisé pour des applications multipoints connectés à un PC ou API.

En mode 2 fils Half-Duplex (RS-485) le contrôle du sens de la transmission sur le bus est gérée directement par les données. Dans ce cas le convertisseur détermine automatiquement le retournement du bus en fonction du sens des données qui sont transmises.

On peut ainsi l'utiliser pour connecter des équipements qui ne possèdent pas de gestion par contrôle de flux.

La vitesse maximum pour le débit des données est de 115,2 Kbit/s

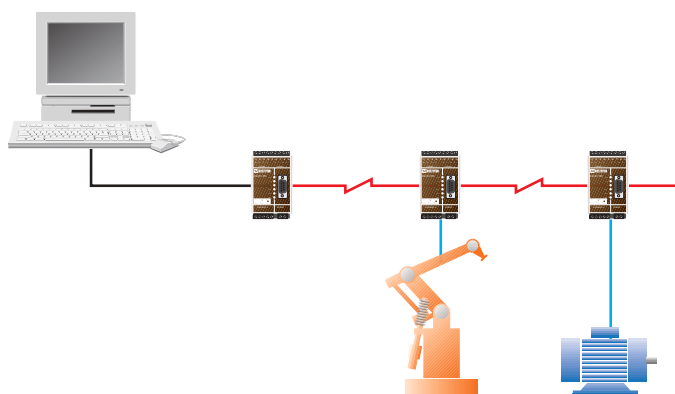

2. Sécurité



Généralités :

Lire le manuel en détails et s'assurer de la bonne compréhension de son contenu avant de mettre en service cet équipement.

Vérifier que votre application n'excède pas les spécifications techniques de fonctionnement de cet équipement.



Avant toute intervention sur ce matériel :

Afin d'éviter tout risque de destruction par décharges électrostatiques (OSD) des éléments internes, référez votre corps à la terre (Par ex : utiliser des bracelets antistatiques).



Installation :

Cet équipement est conçu pour un usage industriel. Il doit être installé dans un local technique dont l'accès est limité aux seules personnes autorisées.

Cet équipement est destiné à être alimenté en permanence par une source AC/DC et ne peut être installé que par du personnel qualifié.

La source d'alimentation AC/DC doit comporter des protections électriques adaptées et doit permettre autant que possible de débrancher manuellement l'équipement.

S'assurer de la bonne conformité de l'installation avec la réglementation nationale en vigueur.

Tout équipement ayant une tension d'alimentation supérieure à 42,4V crête ou 60V DC est un équipement de classe I et doit être raccordé à la terre.

Tout équipement ayant une tension d'alimentation inférieure à 42,4V crête ou 60V DC est un équipement de classe III et doit être séparé des tensions dangereuses par une double isolation renforcée.

Cet équipement utilise une ventilation par convection. Veiller à laisser suffisamment d'espace tout autour de celui-ci pour permettre une bonne ventilation.

(Se reporter au chapitre installation).

3. Homologations

La conformité à la directive 73/23/EEC (Directive basse tension) à été obtenue par application du standard EN 60 950.

La conformité à la directive 89/339/EEC (Compatibilité Electromagnétique) à été obtenue par l'application des standards EN 61000-6-2 (Immunité Industrielle) et EN 61000-6-3 (Emission résidentielle).

3.1 Déclaration de conformité

Westermo Teleindustri AB

Declaration of conformity

The Westermo Teleindustri AB company declares that the listed products conforms to the Council Directive 89/336/EEC, related to Electro Magnetic Compability and 72/23/EEC Low Voltage Directive.

Type of equipment: DIN-rail converter RS232-RS422/485
Model: MD-45 AC 3157-0101, 3157-0110
MD-45 HV 3157-1101
MD-45 LV 3157-0001

Standards:

EMC: EN 61000-6-3/CISPR22(EN 55022): Class B
EN 61000-6-2/EN 61000-4-2
EN 61000-6-2/EN 61000-4-3
EN 61000-6-2/EN 61000-4-4
EN 61000-6-2/EN 61000-4-5
EN 61000-6-2/EN 61000-4-6
EN 61000-6-2/EN 61000-4-11
EN 61000-6-2/EN 61000-4-16
Safety: EN 60950

Reference: Installation manual MD-45 AC/HV,LV Art. Nr. 6157-2003



Hans Levin
Technical Manager
May 2003

Postadress/Postal address	Tel.	Telefax	Postgiro	Bankgiro	Org.nr/ Corp. identity number	Säte/ Registered office
S-640 40 Stora Sundby Sweden	016 - 42 80 00 Int +46 16 42 80 00	016 11 42 80 01 Int +46 16 42 80 01	52 72 79-4	5671-5550	556361-2604	Eskilstuna

4. Spécifications

4.1 Alimentation

Power

Référence Modèle	MD-45 AC	MD-45 LV	MD-45 HV
Tension d'alimentation	230 VAC	12–30 VAC 12–48 VDC	95–240 VAC 110–250 VDC
Plage d'alimentation	207–253 VAC	10–45 VAC 9,6–60 VDC	85.5–264 VAC 88–300 VDC
Consommation	22 mA	300 mA	25 mA @ 240 V, 50 mA @ 95 V
Fréquence	48–62 Hz	48–62 Hz	48–62 Hz
Polarité	PH, N et Terre	Indépendant	PH,N et Terre
Connexion	Bornier à vis 3 positions	Bornier à vis 2 positions	Bornier à vis 3 positions
Section conducteurs	0.2 – 2.5 mm ² (AWG 24-12)		
Fusible	Doit être équipé d'une protection externe		

RS-485/422

Spécifications électrique	RS-422/485
Vitesse	1 200 – 115 200 bit/s
Connexion	Bornier à vis 5 positions
Section conducteur	0.2 – 2.5 mm ² (AWG 24-12)
Type de circuit	TNV-1

RS-232

Spécification électrique	RS-232-C
Vitesse	1 200 – 115 200 bit/s
Connexion	Connecteur Sub-D 9 points femelle, DCE
Type de circuit	SELV

4.2 Isolation entre interfaces

Alimentation

(MD-45 HV et AC)

vers toutes autres 3,0 kV RMS@ 50 Hz et durant 60 s

Alimentation

(MD-45 LV)

vers toutes autres 1,0 kV RMS@ 50 Hz et durant 60 s

RS-232 et RS-485/422

1,0 kV RMS@ 50 Hz et durant 60 s

4.3 Environnement climatique

Température de fonctionnement	5 à 55°C
Température de transport et stockage	-25 à 70°C
Humidité relative en fonctionnement	5 à 95% (Non condensée)
Humidité relative de transport et stockage	5 à 95% (condensation permise à l'extérieur de l'emballage.)

4.4 Mécaniques

Dimensions (W x H x D)	55 x 100 x 128 mm (LxHxP)
Poids	0,5 Kg AC et 0,25 Kg HV et LV
Montage	Verrouillage sur rail DIN de 35 mm
Degré de protection	IP 20 (IEC 529)

5. Maintenance

Aucune intervention est nécessaire tant que l'équipement est utilisé dans les conditions spécifiées.

6. Installation

6.1 Fixation / Démontage



Recommandations avant de fixer ou de démonter l'équipement :

Afin d'éviter tout risque de destruction par décharges électrostatiques (ESD) des éléments internes, Référez votre corps à la terre (Par ex: utiliser des bracelets antistatiques).

Débrancher l'équipement de la source d'alimentation AC/DC ainsi que toutes les autres connexions pour éviter tout risque d'électrocution.

Fixation

Cet équipement doit être installé sur un rail DIN 35mm fixé horizontalement sur un mur ou dans une armoire technique.

Cet équipement utilise une ventilation par convection. Laisser un dégagement suffisant autour de l'équipement en suivant les instructions suivantes:

Zone de dégagement recommandée, Dessus/Dessous: 25 mm.

Droite/Gauche: 10 mm.

Fixation par verrouillage (Voir Figure)

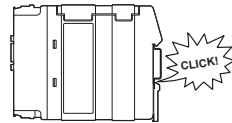
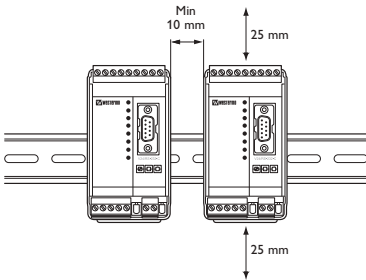
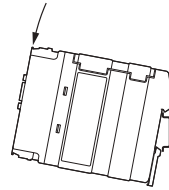

Démontage

Tirez l'agrafe noire situé au dos de l'équipement vers le bas à l'aide d'un tournevis. (Voir Figure).

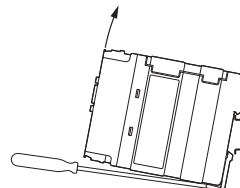
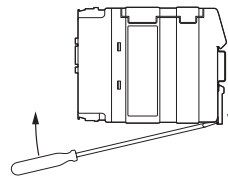

6.2 Connexions

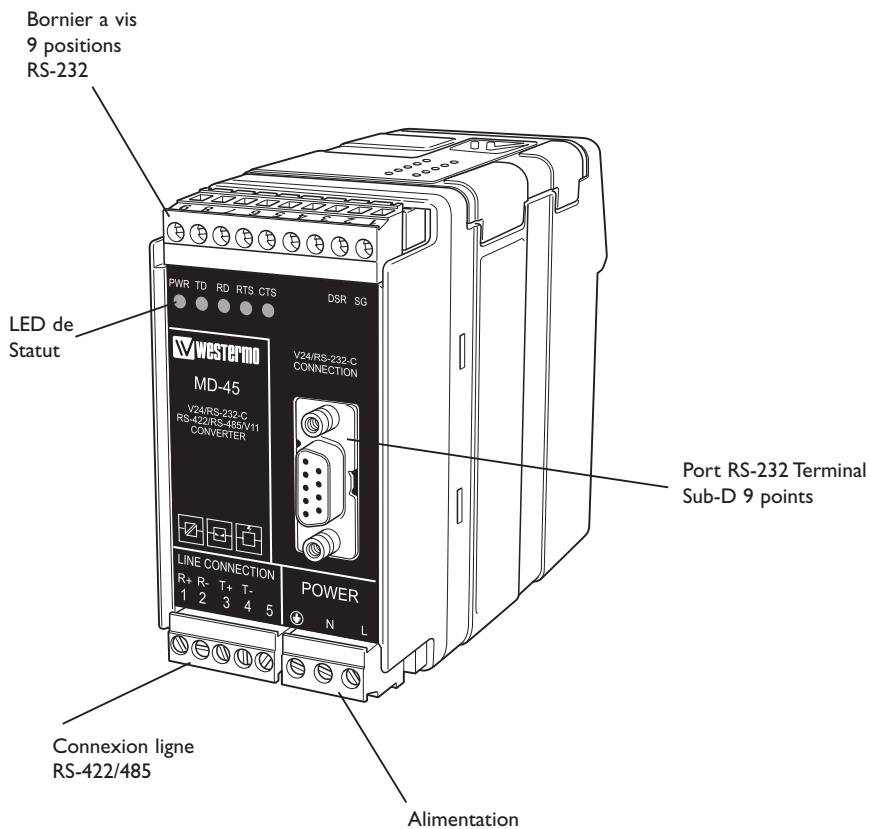

6.2.1 Indicateurs de statuts LED

PWR	Témoin d'alimentation
RTS	Signal modem Request To Send
TD	Transmission de données: Indique que des données sont reçues du port local RS-232/422/485
RD	Réception de données : Indique que des données sont envoyés sur le port local RS-232/422/485
CTS	Signal modem Clear To Send

6.2.2 Alimentation (MD-45 HV et AC)

Bornier à vis 3 positions	Description
L	Phase
N	Neutre
	Terre



6.2.3 Power (MD-45 LV)

Bornier à vis 2 positions	Description
N° 1	Tension –
N° 2	Tension +



6.2.4 Connexion ligne (RS-422/485)

Bornier à vis 5 positions	Direction	Description
N° 1	Entrée	A' (R+)
N° 2	Entrée	B' (R-)
N° 3	Entrée/Sortie	A (T+)
N° 4	Entrée/Sortie	B (T-)
N° 5	–	Blindage



6.2.5 Connexion Terminal (RS-232, DCE)

Bornier à vis N°	Sub-D 9 points	Direction	Description
7	2	Sortie	Réception Données (RD)
8	3	Entrée	Transmission Données (TD)
1 & 9	5	-	Masse (SG)
2	6	Sortie	Data set ready (DSR)
6	7	Entrée	Request to send (RTS)
5	8	Sortie	Clear to send (CTS)

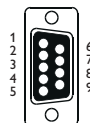

Les bornes 3 et 4 sont non utilisées

6.3 Configuration

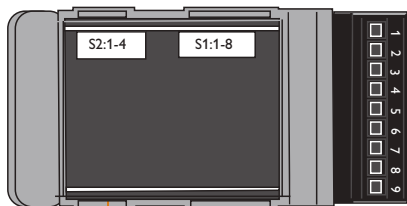

6.3.1 Interrupteurs DIP

Les Interrupteurs DIP se trouvent sous le capot supérieur de l'équipement. Ils permettent la configuration du modem.



Attention !

Avant de démonter le capot du modem, référez votre corps à la terre (Par ex: utiliser des bracelets antistatiques).

Afin d'éviter tout risque de destruction par décharges électrostatiques (OSD) des éléments internes.



Attention ! Ne pas ouvrir un équipement sous tension.

Pour éviter tout risque d'électrocution.

débrancher l'équipement de la source d'alimentation AC/DC ainsi que toutes les autres connexions.

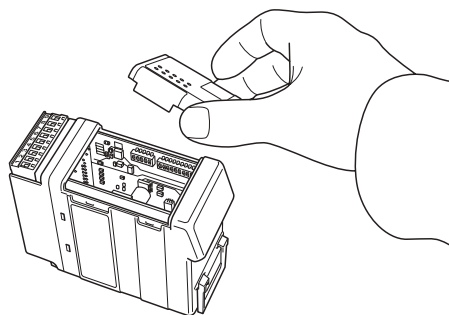

Configuration du débit des données

	Débit Données	Temps retournement
S1	1 200	780 µs
S1	2 400	410 µs
S1	4 800	220 µs
S1	9 600	130 µs
S1	19 200	48 µs
S1	38 400	34 µs
S1	57 600	22 µs
S1	115 200	11 µs

Contrôle RTS ou Flux de Données

S1	Flux de Données
S1	Contrôle RTS
S1	Emetteur toujours actif

Configuration Usine

S1
S2

S1 : 8 non utilisés

Sélection du nombre de bits

S1	9
S1	10
S1	11
S1	12

Transmission 2/4 Fils

S1	2-fils
S1	4-fils

Terminaison avec niveau de sécurité *

S2	Terminé (4 fils)
S2	Terminé (2 fils)
S2	Pas de terminaison

* La fonction niveau de sécurité force l'état du signal récepteur sur OFF quand l'émetteur connecté est en mode 3 états, (émetteur inactif). Le récepteur le plus éloigné doit être équipé d'une terminaison.

Table de contrôle pour sélection du nombre de bits

7 Bits	●	●	●	●			
8 Bits			●		●	●	●
Pas de parité	●	●		●		●	
Parité			●		●		●
1 bit de stop	●		●	●			●
2 bits de stop		●			●	●	
Nombre de bits	9	10	10	10	11	11	12

7.0 Description Fonctionnelle

Lorsque le convertisseur est configuré pour le mode contrôle du retournement par flux de données, l'émetteur est activé par les données transmises sur TD provenant de la RS-232. L'émetteur restera actif durant une période équivalent à un caractère temps. Et le temps de retournement sera déterminé par le format de la transmission : vitesse et nombre de bits. S'il reste des données à transmettre après expiration du temps de retournement l'émetteur restera actif durant un caractère supplémentaire.

Dans le mode du contrôle de retournement par RTS, l'émetteur est activé par le signal RTS. Dans ce cas les interrupteurs DIP déterminant la vitesse et le nombre de bits sont inactifs. Les indicateurs LED sont pilotés par les signaux des données. Les terminaisons actives sécurisent le niveau des récepteurs lorsqu'il n'y a pas de transmission en les forçant dans un état OFF (>0,2Volts).

La transmission Full Duplex est uniquement supportée en RS-422.

7.1 Diagramme Simplifié

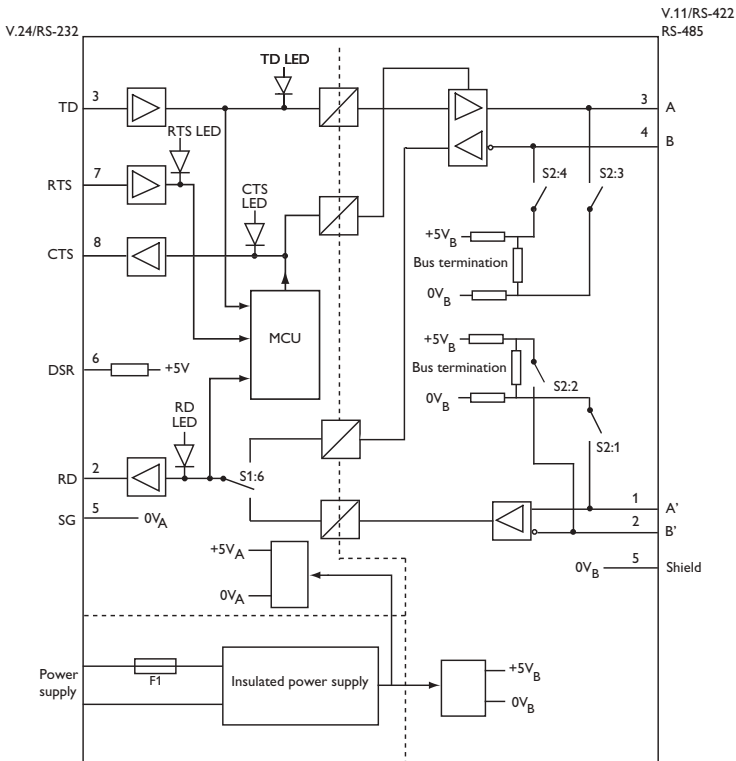

7.2 Connexion Ligne

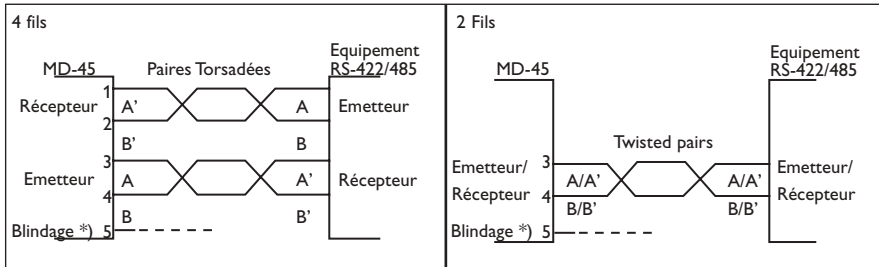

*) Si on utilise un câble blindé, connecter le blindage uniquement à une extrémité afin d'éviter les retours de courant de terre.

7.3 Conseils Pratiques

Le MD-45 utilise une interface RS-422/485. Le standard RS422/485 a été conçu pour des applications multipoints.

Le réseau est installé sous la forme d'une structure bus (voir diagramme).

Les réseaux en forme d'étoile sont proscrits.

Il existe d'autres produits Westermo qui permettent de travailler avec un réseau en étoile.

Une installation correcte d'un réseau RS-422/485 doit toujours être équipée d'une terminaison sur les points correspondants.

Il est indispensable d'équiper de terminaisons le récepteur de l'unité maître ainsi que le dernier esclave qui termine le bus.

Le diagramme ci-contre vous montre comment est réalisée une connexion RS-485 (2 fils) et RS-422 (4 fils)

La fonction émission utilisée dans le MD-45 est activée directement par les données reçu sur le port RS-232.

Contrairement aux convertisseurs conventionnels qui se réfèrent aux signaux de contrôle (Par ex : RTS)

Si un problème survient pendant la configuration du MD-45, les LED de statut peuvent vous aider.

- PWR : L'unité est alimentée
- RD : Réception de données sur l'interface RS-422/485.
- CTS : Suit le signal RTS.
- RTS : Statut du signal RTS provenant de l'interface RS-232.
- TD : Réception de données sur l'interface RS-232/V.24

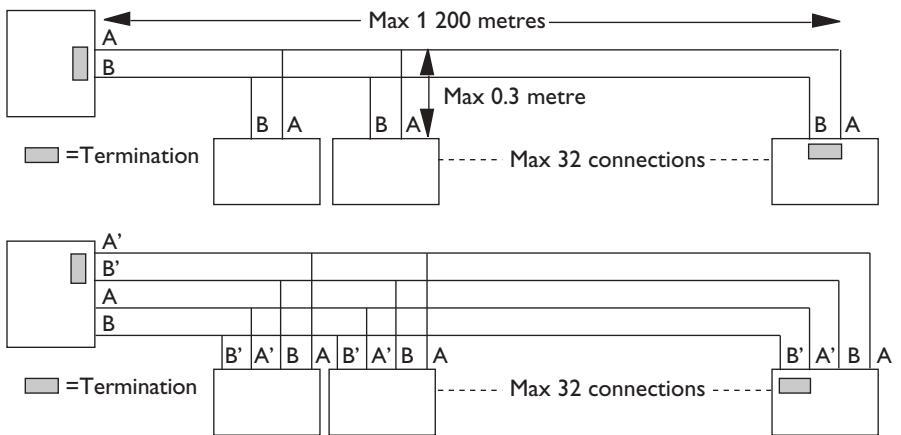

Nota : Les définitions R+/R-,T+/T- ne sont pas standard. On peut résoudre dans certains cas des problèmes de connexion en inversant les fils A et B si les équipements ne fonctionnent pas.



Westermo • SE-640 40 Stora Sundby, Sweden
Tel +46 16 42 80 00 Fax +46 16 42 80 01
E-mail: info@westermo.com
www.westermo.com

Sales Units

Sweden

Westermo Data Communications
Svalgängen 1, Vallbyinstitutet, 724 81 Västerås
Tel: +46 (0) 21 548 08 00 • Fax: (0) 21 35 18 50
info.sverige@westermo.se • www.westermo.se

United Kingdom

Westermo Data Communications
Talisman Business Centre
Duncan Road, Park Gate, Southampton. SO31 7GA
Tel: +44 (0) 1489 580 585 • Fax: +44 (0) 1489 580 586
sales@westermo.co.uk • www.westermo.co.uk

Germany

Westermo Data Communications
Goethe Strasse 67
DE-68753 Waghäusel
Tel: +49 (0) 7254 95400-0 • Fax: +49 (0) 7254-95400-9
info@westermo.de • www.westermo.de

Austria

Westermo Data Communications
Tel: +43 (0) 72030 3920 • Fax: +43 (0) 2235 86131
info@westermo.at • www.westermo.at

France

Westermo Data Communications
Bat. A, 9 Chemin de Chilly
FR-91160 Champlan
Tel: +33 1 69 10 21 00 • Fax: +33 1 69 10 21 01
infos@westermo.fr • www.westermo.fr

Singapore

Westermo Data Communications
2 Soon Wing Road #08-05,
Soon Wing Industrial Building
Singapore 347893
Tel: +65 6743 9801 • Fax: +65 6745 0670
sales@westermo.com.sg • www.westermo.com.sg

North America

Westermo Data Communications
939 N. Plum Grove Road, Suite F,
IL 60173 Schaumburg, USA
Tel: +1 847 619 6068 • Fax: +1 847 619 66 74
info@westermo.com • www.westermo.com

Taiwan

Westermo Data Communications
F2, No. 188, Pao-Chiao Rd. Shing-Tien City,
Taipei 23145
Tel: +886 2 8911 1710
sales.cn@westermo.com • www.cn.westermo.com

China

Westermo Data Communications
2F Building B
No.1618 Yishan Road
Shanghai 201103
Tel: +86 21 6145 0400 • Fax: +86 21 6145 0499
sales.cn@westermo.com • www.cn.westermo.com

Westermo Teleindustri AB have distributors in several countries, contact us for further information.