

User Guide
6644-2240



SDW-500 S E R I E S

SDW-541-F1G-T4G
SDW-550-T5G



**Industrial Ethernet
5-port Switch**

www.westermo.com

Legal information

The contents of this document are provided "as is". Except as required by applicable law, no warranties of any kind, either express or implied, including, but not limited to, the implied warranties of merchantability and fitness for a particular purpose, are made in relation to the accuracy and reliability or contents of this document. Westermo reserves the right to revise this document or withdraw it at any time without prior notice.

Under no circumstances shall Westermo be responsible for any loss of data or income or any special, incidental, and consequential or indirect damages howsoever caused.

More information about Westermo can be found at the following Internet address:

<http://www.westermo.com>

Safety



Before installation:

Read this manual completely and gather all information on the unit. Make sure that you understand it fully. Check that your application does not exceed the safe operating specifications for this unit.

This unit should only be installed by qualified personnel.

This unit should be built-in to an apparatus cabinet, or similar, where access is restricted to service personnel only.

The power supply wiring must be sufficiently fused, and if necessary it must be possible to disconnect manually from the power supply. Ensure compliance to national installation regulations.

This unit uses convection cooling. To avoid obstructing the air flow around the unit, follow the spacing recommendations (see Installation section).



Before mounting, using or removing this unit:

Prevent access to hazardous voltage by disconnecting the unit from power supply. Warning! Do not open connected unit. Hazardous voltage may occur within this unit when connected to power supply.



Class 1 Laser Product

Do not look directly into fibre optical fibre port or any connected fibre although this unit is designed to meet the Class 1 Laser regulations.

Care recommendations

Follow the care recommendations below to maintain full operation of unit and to fulfil the warranty obligations.

This unit must not be operating with removed covers or lids.

Do not attempt to disassemble the unit. There are no user serviceable parts inside.

Do not drop, knock or shake the unit, rough handling above the specification may cause damage to internal circuit boards.

Do not use harsh chemicals, cleaning solvents or strong detergents to clean the unit.

Do not paint the unit. Paint can clog the unit and prevent proper operation.

Do not expose the unit to any kind of liquids (rain, beverages, etc). The unit is not waterproof. Keep the unit within the specified humidity levels.

Do not use or store the unit in dusty, dirty areas, connectors as well as other mechanical part may be damaged.

If the unit is not working properly, contact the place of purchase, nearest Westermo distributor office or Westermo Tech support.

Fibre connectors are supplied with plugs to avoid contamination inside the optical port.

As long as no optical fibre is mounted on the connector, e.g. for storage, service or transportation, should the plug be applied.

SPECIAL CONDITION FOR SAFE USE

Ambient temperature:

This unit is designed for use in extreme ambient temperature conditions according to the following: -40 °C to +74 °C (-40 °F to +165 °F)

Note. Fibre Optic Handling

Fibre optic equipment needs special treatment. It is very sensitive to dust and dirt. If the fibre will be disconnected from the modem the protective hood on the transmitter/receiver must be connected. The protective hood must be kept on during transportation. The fibre optic cable must also be handle the same way.

If this recommendation is not, it jeopardises the warranty.

Cleaning of the optical connectors

In the event of contamination, the optical connectors should be cleaned by the use of forced nitrogen and some kind of cleaning stick.

Recommended cleaning fluids:

- Methyl-, ethyl-, isopropyl- or isobutyl-alcohol
- Hexane
- Naphtha

Maintenance

No maintenance is required, as long as the unit is used as intended within the specified conditions.

Agency approvals and standards compliance

Type	Approval / Compliance
EMC	EN 50121-4, Railway applications – Electromagnetic compatibility – Emission and immunity of the signalling and telecommunications apparatus
	EN 61000-6-1, Immunity residential environments
	EN 61000-6-2, Immunity industrial environments
	EN 61000-6-4, Emission industrial environments

Declaration of Conformity



Westermo Teleindustri AB

Declaration of conformity

The manufacturer Westermo Teleindustri AB
SE-640 40 Stora Sundby, Sweden

Herewith declares that the product(s)

Type of product	Model	Art no
Industrial Ethernet switch	SDW-550-T5G	3644-2001
	SDW-541-F1G-T4G	3644-2020

is in conformity with the following EC directive(s).

No	Short name
2014/30/EU	Electromagnetic Compatibility (EMC)
2011/65/EU	Restriction of the use of certain hazardous substances in electrical and electronic equipment (RoHS)

References of standards applied for this EC declaration of conformity.

No	Title	Issue
EN 61000-6-1	Electromagnetic compatibility – Immunity for residential environments	2007
EN 61000-6-2	Electromagnetic compatibility – Immunity for industrial environments	2005
EN 61000-6-4	Electromagnetic compatibility – Emission for industrial environments	2007
EN 50121-4	Railway applications – Electromagnetic compatibility – Emission and immunity of the signalling and telecommunications apparatus	2015
EN 50581	Technical documentation for the assessment of electrical and electronic products with respect to the restriction of hazardous substances	2012

The last two digits of the year in which the CE marking was affixed: 15

Signature

Pierre Öberg
Technical Manager
02nd November 2015

Postadress/Postal address	Tel.	Telefax	Postgiro	Bankgiro	Org.nr/ Corp. identity number	Registered office
S-640 40 Stora Sundby Sweden	016-428000	016-428001	52 72 79-4	5671-5550	556361-2604	Eskilstuna
	Int+46 16428000	Int+46 16428001				

Type tests and environmental conditions

Environmental phenomena	Basic standard	Description	Test levels
ESD	EN 61000-4-2	Enclosure	Contact: ± 6 kV Air: ± 8 kV
Fast transients	EN 61000-4-4	Power port	± 2 kV
		Signal ports	± 2 kV
Surge	EN 61000-4-5	Power port	Line to earth: ± 2 kV Line to line: ± 1 kV
		Signal ports	Line to earth: ± 2 kV Line to line: ± 1 kV
Power frequency magnetic field	EN 61000-4-8	Enclosure	300 A/m; 0, 16.7, 50 Hz
Pulsed magnetic field	EN 61000-4-9	Enclosure	300 A/m
Radiated RF immunity	EN 61000-4-3	Enclosure	20 V/m @ (800 – 2700) MHz 10 V/m @ (2700 – 6000) MHz 1 kHz sine, 80% AM
Conducted RF immunity	EN 61000-4-6	Power port	10 V, 80% AM, 1 kHz; (0.15 – 80) MHz
		Signal ports	10 V, 80% AM, 1 kHz; (0.15 – 80) MHz
Radiated RF emission	CISPR 16-2-3	Enclosure	Class B
	ANSI C63.4 (FCC Part 15)		Class B, (30 – 6500 MHz)
Conducted RF emission	CISPR 16-2-1	Power port	Class B
		Signal ports	Class B
Dielectric strength	EN 60950-1	Power interface to all other	1.5kV AC @ 60s duration
		TX signal interface to all other	1.5kV AC @ 60s duration
		TX shield interface to all other	1.5kV AC @ 60s duration
Environmental			
Temperatures	EN 60068-2-1	Operating	-40 to +74 °C (-40 to +165 °F)
	EN 60068-2-2	Storage and transport	-50 to +85 °C (-40 to +185 °F)
Relative humidity	EN 60068-2-30	Operating	5 to 95 % (non-condensing)
		Storage and transport	5 to 95 % (condensation allowed outside packaging)
Altitude		Operating	2 000 m/70 kPa
Service life		Operating	10 year
Reliability prediction (MTBF)	MIL-HDBK-217F	Operating	SDW-541-F1G-T4G: 1.182.000 hours SDW-550-T5G: 1.121.000 hours
Vibration	IEC 60068-2-6 (sine)	Operating	5-8 Hz: 7.5 mm
			30-50 Hz: 0.42 mm
			8-500 Hz: 2 g
Shock	IEC 60068-2-27	Operating	15 g, 11 ms
Mechanical			
Enclosure	UL94	Plastic	Flammability Class V-1
Dimension W x H x D			34 x 123 x 121 mm
Weight			0.2 kg
Mounting		DIN-rail	
Degree of protection	EN 60529	Enclosure	IP 21
Cooling			Convection

Configuration

Auto configured (auto-negotiation) or manually setting of speed and duplex of individual TX port, by DIP-switches. Port mirror function is possible to set with DIP-switch. With the port mirror function active the switch will copy all outgoing traffic to port 1. This can be used to monitor all traffic going out from the switch. Packets may be discarded if the total throughput exceeds the port speed of port 1.

Description

The SDW-541-F1G-T4G is an unmanaged 5-port switch with one SFP fibre port and four copper ports, all supporting 100 Mbit/s or Gbit Ethernet. The Westermo range of 100Mbit or Gbit Small Form-factor Pluggable (SFP) transceivers are available as multimode, singlemode or Bi-Di transceivers with distance up to 120 km.

The SDW-550-T5G is an unmanaged 5-port switch with five copper ports, all supporting 10 Mbit/s, 100 Mbit/s or Gbit Ethernet. Both are designed for easy use in heavy duty industrial, maritime and rail trackside applications. The units support 802.1Q long packets which allow all standard industrial Ethernet protocols to be used.

The units are designed for use in industrial applications with dual 10 to 57 VDC power input. The unique “tri-galvanic” isolation provides isolation between all ports, power supply and between each chassis screen avoiding ground loop currents. The IP21 rating ensures that the unit can be installed in locations where condensed water may occur. Only industrial grade components are used which gives an MTBF of 1.182.000 hours for the SDW-541-F1T4G and 1.121.000 hours for the SDW-550-T5G and thus ensures a long service life. A wide operating temperature range of -40 to +74 °C (-50 to +165 °F) can be achieved with no moving parts.



The units have been tested both by Westermo and external test houses to meet EMC, isolation, vibration and shock standards, all to the highest levels suitable for heavy industrial, trackside and maritime environments.

Network diagnostics are simplified with the inclusion of port mirroring on one port allowing data flow through the switch to be monitored using a network analyzer. All five ports can have data rate and flow control locked by DIP switch which can eliminate problems with old legacy Ethernet equipment that is unable to support auto negotiation.

Interface specifications

Power	
Operating voltage	Rated: 12 to 48 VDC Operating: 9.6 to 57 VDC
Rated current	SDW-541-F1G-T4G: 100 mA@12 VDC SDW-550-T5G: 60 mA@12 VDC
Rated frequency	DC
Inrush current, I^2t	$22.7 \cdot 10^{-3} \text{ A}^2\text{s @ 48 VDC}$
Startup current*	2 x Rated current
Polarity	Reverse polarity protected
Redundant power input	Yes
Isolation to	All other
Connection	Detachable screw terminal
Connector size	0.2 – 2.5 mm ² (AWG 24 – 12)
Shielded cable	Not required

* External supply current capability for proper start-up

Ethernet TX	
Electrical specification	IEEE std 802.3. 2005 Edition
Data rate	10 Mbit/s, 100 Mbit/s, 1000 Mbit/s manual or auto
Duplex	Full or half, manual or auto
Circuit type	TNV-1
Transmission range	Up to 150 m with CAT5e cable or better*
Isolation to	All other
Connection	RJ-45, auto MDI/MDI-X
Shielded cable	Not required, except when installed in Railway applications as signalling and telecommunications apparatus and located close to rails.**
Conductive housing	Yes
Number of ports	SDW-541-F1G-T4G: 4 SDW-550-T5G: 5

* Refer to Safety section.

** To minimise the risk of interference, a shielded cable is recommended when the cable is located inside 3 m boundary or the cable is longer than 30 m and inside 10 m boundary to the rails and connected to this port.

Ethernet SFP pluggable connections (FX or TX) (SDW-541-F1G-T4G)	
Electrical specification	IEEE std 802.3. 2005 Edition
Data rate	100 Mbit/s or 1000 Mbit/s transceivers supported
Duplex	Full or Auto, depending on transceiver
Transmission range	Depending on transceiver
Connection	SFP slot holding fibre transceiver or copper transceiver
Number of ports	SDW-541-F1G-T4G: 1

Connections

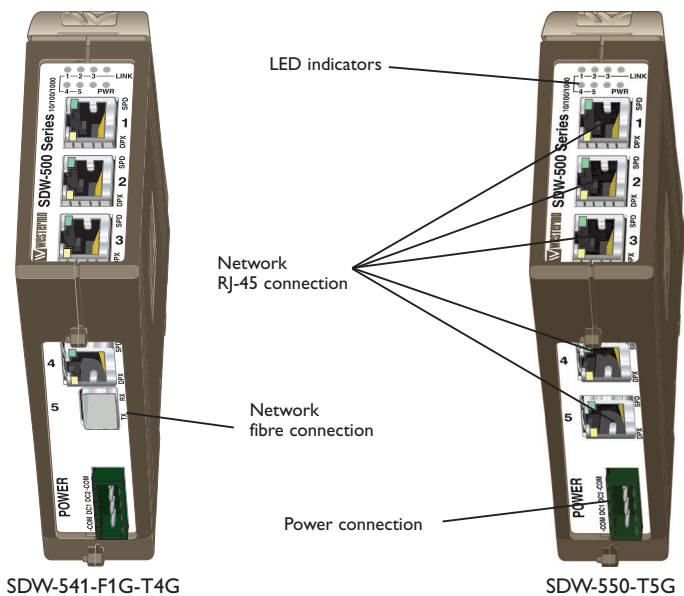

Available models:

- ⌘ SDW-541-F1G-T4G 10/100/1000Base-T/TX: 4 ports, 100/1000Base-FX: 1 port
- ⌘ SDW-550-T5G 10/100/1000Base-T/TX: 5 ports

Power

The SDW-500 series supports redundant power connection. The positive inputs are DC1 and DC2, the negative inputs for both supplies are –COM. The power is drawn from the input with the highest voltage.

4-pos screw terminal	Description	Power
1	–COM	0V
2	DC1	9.6–57.6 VDC
3	DC2	9.6–57.6 VDC
4	–COM	0V



TX

Ethernet TX connection (RJ-45 connector), automatic MDI/MDI-X crossover.

Contact	Direction	Description/Remark
1	In/Out	BI_DA+
2	In/Out	BI_DA-
3	In/Out	BI_DB+
4	In/Out	BI_DC+
5	In/Out	BI_DC-
6	In/Out	BI_DB-
7	In/Out	BI_DD+
8	In/Out	BI_DD-
Shield	In/Out	Connected to PE



CAT 5 cable is recommended.

Unshielded (UTP) or shielded (STP) connector might be used.

F1G, 1 SFP slots

The F1G interface has one SFP slot supporting Ethernet 10/100/1000 BaseFX/X. Each slot can hold one SFP transceiver for copper or fibre cable. For supported transceivers see SFP transceivers user guide (art no. 6100-0000) available at www.westermo.com.

DIP switch settings SDW-541-F1G-T4G and SDW 550-T5G

DIP-switches are accessible under the lid on top of the unit. DIP-switches are used to configure the unit.



Warning!

Prevent damage to internal electronics from electrostatic discharges (ESD) by discharging your body to a grounding point (e.g. use of wrist strap), before the lid on top/front of the unit is removed.



Warning! Do not open connected equipment.

Prevent access to hazardous voltages by disconnecting the unit from AC/DC mains supply and all other electrical connections.

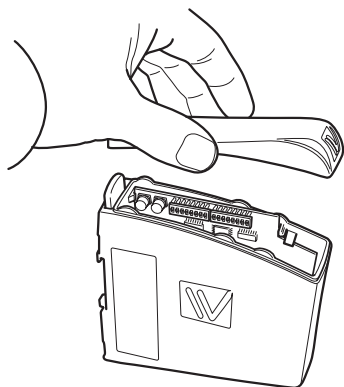

NOTE

When configuration via DIP-switches, the settings of DIP-switches configure the unit only after a reboot (power off/on).

Observe this when the DIP-switches are configured

- ⌘ Speed and duplex setting only valid when auto-negotiation is disabled.
- ⌘ When monitoring selected all outgoing packets from the switch is also copied to the port 1.
- ⌘ Speed and duplex switch settings are ignored for FX ports.
- ⌘ If auto-negotiation and auto MDI/MDI-X disabled all TX ports support MDI-X configuration.
- ⌘ If Hub mode is selected, all incoming and outgoing packets are distributed on all other ports.

ONLY VALID FOR SDW-541-F1G-T4G

- ⌘ Speed and duplex switch settings are ignored for FX ports.
- ⌘ If auto-negotiation and auto MDI/MDI-X disabled all TX ports support MDI-X configuration.

Port settings

Port 1 settings

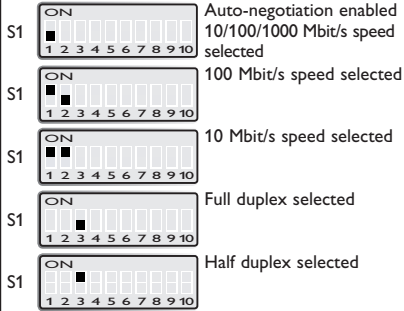

Port 2 settings

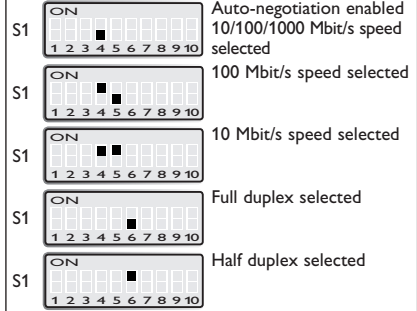

Port 3 settings

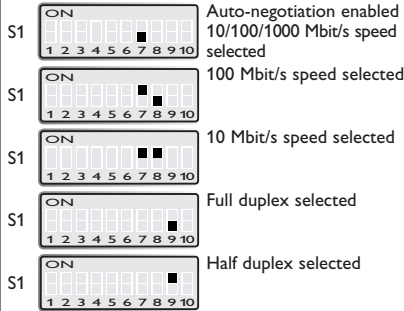

Port 4 settings

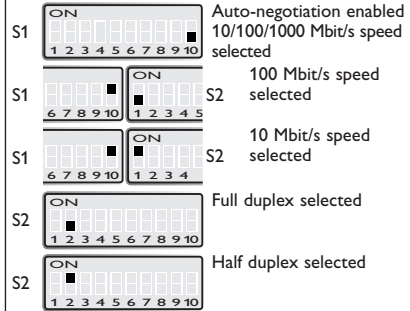

Port 5 settings

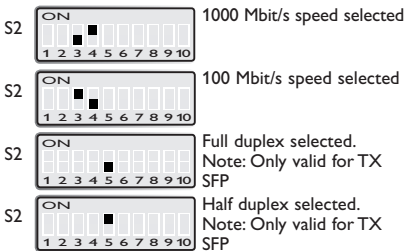

Factory settings



Port mirroring settings

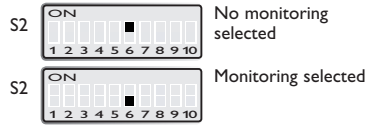

Hub mode

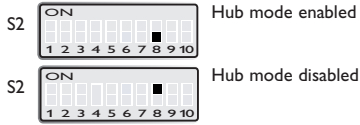

Flow control selected

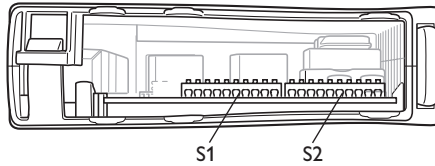
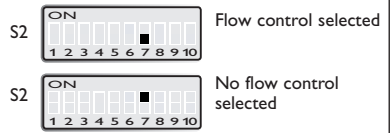

LED indicators

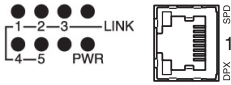

Indicators (LED)

Power (PWR)

Link (LINK) of every port

Speed (SPD) and duplex (DPX) of TX ports

LED	Status	Description
PWR	ON	Internal power, initialising OK
	Slow flash	Initialisation progressing
	Fast flash	Initialisation error
LINK/SPD	OFF	No Ethernet link
	ON	Good Ethernet link
	Flash	Ethernet data is transmitted or received, traffic indication
	Flash 3 Hz	10 Mbit/s
	Flash 6 Hz	100 Mbit/s
	Flash 12 Hz	1000 Mbit/s
DPX	OFF	Half duplex
(TX only)	ON	Full duplex

SFP Transceivers

The unit supports Westermo labelled transceivers only.

See Westermo's modular transceivers datasheets 100 Mbit and 1 Gbit for supported SFP transceivers. See Transceiver User Guide "6100-0000" for transceiver handling instructions.



Mounting

This unit should be mounted on 35 mm DIN-rail, which is horizontally mounted on a wall or cabinet backplate. Snap on mounting, see figure.

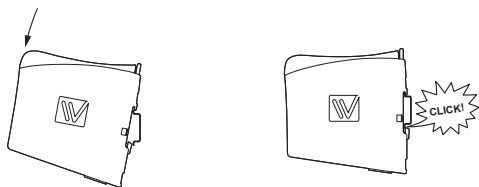

Removal

Press down the black support at the back of the unit, see figure.



Cooling

This unit uses convection cooling. To avoid obstructing the airflow around the unit, use the following spacing rules. Minimum spacing 25 mm (1.0 inch) above / below and 10 mm (0.4 inches) left / right the unit. Spacing is recommended for the use of unit in full operating temperature range and service life.

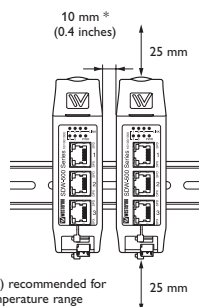



Westermo • SE-640 40 Stora Sundby, Sweden
Tel +46 16 42 80 00 Fax +46 16 42 80 01
E-mail: info@westermo.com
www.westermo.com

Sales Units

Westermo Data Communications

China

sales.cn@westermo.com
www.cn.westermo.com

France

infos@westermo.fr
www.westermo.fr

Germany

info@westermo.de
www.westermo.de

North America

info@westermo.us
www.westermo.us

Singapore

sales@westermo.com.sg
www.westermo.com

Sweden

info.sverige@westermo.se
www.westermo.se

United Kingdom

sales@westermo.co.uk
www.westermo.co.uk

Other Offices



For complete contact information, please visit our website at www.westermo.com/contact or scan the QR code